

Arm® Architecture Reference Manual
Supplement
Memory System Resource Partitioning and Monitoring
(MPAM), for A-profile architecture

arm

Arm Architecture Reference Manual Supplement

Memory System Resource Partitioning and Monitoring (MPAM), for A-profile architecture

Copyright © 2018-2022 Arm Limited or its affiliates. All rights reserved.

Release Information

The following releases of this document have been made.

				Release history
Date	Issue	Confidentiality	Change	
30 October 2018	A.a	Non-Confidential	EAC release	
05 July 2019	A.b	Non-Confidential	Updated EAC release	
21 February 2020	B.a	Non-Confidential	Updated EAC release incorporating MPAMv0.1 and MPAMv1.1 architectures	
17 July 2020	B.b	Non-Confidential	Updated EAC release	
22 January 2021	B.c	Non-Confidential	Updated EAC release	
23 June 2021	C.a	Non-Confidential	Updated EAC release incorporating MPAM for Realm Management Extension	
19 October 2021	C.b	Non-Confidential	Updated EAC release integrating v1.1 for Realm Management Extension (RME)	
29 April 2022	D.a	Non-Confidential	Updated EAC release incorporating MPAM 2021 Extensions.	

Proprietary Notice

This document is protected by copyright and other related rights and the practice or implementation of the information contained in this document may be protected by one or more patents or pending patent applications. No part of this document may be reproduced in any form by any means without the express prior written permission of Arm. **No license, express or implied, by estoppel or otherwise to any intellectual property rights is granted by this document unless specifically stated.**

Your access to the information in this document is conditional upon your acceptance that you will not use or permit others to use the information for the purposes of determining whether implementations infringe any third party patents.

THIS DOCUMENT IS PROVIDED “AS IS”. Arm PROVIDES NO REPRESENTATIONS AND NO WARRANTIES, EXPRESS, IMPLIED OR STATUTORY, INCLUDING, WITHOUT LIMITATION, THE IMPLIED WARRANTIES OF MERCHANTABILITY, SATISFACTORY QUALITY, NON-INFRINGEMENT OR FITNESS FOR A PARTICULAR PURPOSE WITH RESPECT TO THE DOCUMENT. For the avoidance of doubt, Arm makes no representation with respect to, and has undertaken no analysis to identify or understand the scope and content of, patents, copyrights, trade secrets, or other rights.

This document may include technical inaccuracies or typographical errors.

TO THE EXTENT NOT PROHIBITED BY LAW, IN NO EVENT WILL Arm BE LIABLE FOR ANY DAMAGES, INCLUDING WITHOUT LIMITATION ANY DIRECT, INDIRECT, SPECIAL, INCIDENTAL, PUNITIVE, OR CONSEQUENTIAL DAMAGES, HOWEVER CAUSED AND REGARDLESS OF THE THEORY OF LIABILITY, ARISING OUT OF ANY USE OF THIS DOCUMENT, EVEN IF Arm HAS BEEN ADVISED OF THE POSSIBILITY OF SUCH DAMAGES.

This document consists solely of commercial items. You shall be responsible for ensuring that any use, duplication or disclosure of this document complies fully with any relevant export laws and regulations to assure that this document or any portion thereof is not exported, directly or indirectly, in violation of such export laws. Use of the word “partner” in reference to Arm’s customers is not intended to create or refer to any partnership relationship with any other company. Arm may make changes to this document at any time and without notice.

This document may be translated into other languages for convenience, and you agree that if there is any conflict between the English version of this document and any translation, the terms of the English version of the Agreement shall prevail.

The Arm corporate logo and words marked with ® or ™ are registered trademarks or trademarks of Arm Limited (or its affiliates) in the US and/or elsewhere. All rights reserved. Other brands and names mentioned in this document may be the trademarks of their respective owners. You must follow the Arm’s trademark usage guidelines <http://www.arm.com/company/policies/trademarks>.

ARM DDI 0598D.a

Arm Limited. Company 02557590 registered in England.
110 Fulbourn Road, Cambridge, England CB1 9NJ.

(LES-PRE-20349 version 21.0)

In this document, where the term Arm is used to refer to the company it means “Arm or any of its subsidiaries as appropriate”.

Confidentiality Status

This document is Non-Confidential. The right to use, copy and disclose this document may be subject to license restrictions in accordance with the terms of the agreement entered into by Arm and the party that Arm delivered this document to.

Product Status

The information in this document is final, that is for a developed product.

The information in this manual is at EAC quality, which means that all features of the specification are described in the manual.

Web Address

<http://www.arm.com>

Contents

	Preface	
	About this book	x
	Using this book	xi
	Conventions	xiii
	Additional reading	xiv
	Feedback	xv
Chapter 1	Introduction	
1.1	Overview	1-18
1.2	Memory-system resource partitioning	1-19
1.3	Memory-system resource usage monitoring	1-20
1.4	Memory-system components	1-21
1.5	Versions of the MPAM Extension	1-22
1.6	Implementation flexibility	1-30
1.7	Example uses	1-31
Chapter 2	MPAM and Arm Memory-System Architecture	
2.1	Overview	2-34
Chapter 3	ID Types, Properties, and Spaces	
3.1	Introduction	3-36
3.2	ID types and properties	3-37
3.3	Physical address spaces	3-38
3.4	PARTID spaces and properties	3-39
Chapter 4	Memory System Propagation of MPAM Information	
4.1	Introduction	4-42
4.2	Requester components	4-43
4.3	Terminating Completer components	4-44
4.4	Intermediate Completer-Requester components	4-45
4.5	Request buffering	4-46
4.6	Cache memory	4-47
4.7	MPAM for RME propagation of MPAM_SP with requests	4-48
Chapter 5	System Model	
5.1	Introduction	5-50
5.2	System-level field widths	5-52
5.3	PE behavior	5-53

5.4	Other Requesters with MPAM	5-54
5.5	Requesters without MPAM support	5-55
5.6	Model of a resource partitioning control	5-56
5.7	Interconnect behavior	5-57
5.8	Cache behavior	5-58
5.9	Memory-channel controller behavior	5-60
5.10	The MPAM for RME system	5-61
Chapter 6	PE Generation of MPAM Information	
6.1	Introduction	6-70
6.2	MPAM System registers	6-71
6.3	Instruction, data, translation table walk, and other accesses	6-74
6.4	Security	6-75
6.5	PARTID virtualization	6-78
6.6	MPAM AArch32 interoperability	6-84
6.7	Support for nested virtualization	6-85
6.8	MPAM errors and default ID generation	6-88
6.9	MPAM for RME PE generation of MPAM information	6-90
Chapter 7	System Registers	
7.1	Overview	7-96
7.2	Synchronization of System register changes	7-97
7.3	Summary of System registers	7-98
7.4	System register descriptions	7-99
7.5	MPAM enable	7-155
7.6	SDEFLT	7-156
7.7	Lower-EL MPAM register access trapping	7-157
7.8	FORCE_NS	7-158
7.9	Reset	7-159
7.10	Unimplemented Exception levels	7-160
Chapter 8	MPAM in MSCs	
8.1	Introduction	8-164
8.2	Resource controls	8-165
8.3	Resource instance selection	8-166
8.4	Security in MSCs	8-171
8.5	Virtualization support in system MSCs	8-172
8.6	PE with integrated MSCs	8-173
8.7	System-wide PARTID and PMG widths	8-174
8.8	MPAM interrupts	8-175
8.9	MSC support of MPAM for RME	8-179
Chapter 9	Resource Partitioning Controls	
9.1	Introduction	9-182
9.2	Partition resources	9-183
9.3	Standard partitioning control interfaces	9-184
9.4	Vendor or implementation-specific partitioning control interfaces	9-196
9.5	Measurements for controlling resource usage	9-197
9.6	PARTID narrowing	9-198
9.7	System reset of MPAM controls in MSCs	9-199
9.8	About the fixed-point fractional format	9-200
Chapter 10	Resource Monitors	
10.1	Introduction	10-204
10.2	MPAM resource monitors	10-205
10.3	Common features	10-208
10.4	Monitor configuration	10-211
10.5	Monitor behavior on overflow	10-212

Chapter 11	Memory-mapped Registers	
11.1	Overview of MMRs	11-216
11.2	Summary of memory-mapped registers	11-222
11.3	Memory-mapped ID register description	11-225
11.4	Memory-mapped partitioning configuration registers	11-267
11.5	Memory-mapped monitoring configuration registers	11-311
11.6	Memory-mapped control and status registers	11-373
Chapter 12	Errors in MSCs	
12.1	Introduction	12-392
12.2	Error conditions in accessing memory-mapped registers	12-393
12.3	Overwritten error status	12-397
12.4	Behavior of configuration reads and writes with errors	12-398
12.5	Optionality of error detection and reporting	12-403
Chapter 13	Pseudocode	
13.1	Shared pseudocode	13-406
Appendix A	Generic Resource Controls	
A.1	Introduction	A-408
A.2	Portion resource controls	A-409
A.3	Maximum-usage resource controls	A-410
A.4	Proportional resource allocation facilities	A-411
A.5	Combining resource controls	A-413
Appendix B	MSC Firmware Data	
B.1	Introduction	B-416
B.2	Partitioning-control parameters	B-417
B.3	Performance-monitoring parameters	B-418
B.4	Discovery of resource to RIS mapping	B-419
B.5	Discovery of wired interrupts	B-420

Preface

This preface introduces the MPAM Extension architecture specification. It contains the following sections:

- *About this book* on page x.
- *Using this book* on page xi.
- *Conventions* on page xiii.
- *Additional reading* on page xiv.
- *Feedback* on page xv.

About this book

This book is the *Architecture Specification* for the *MPAM Extension Architecture Specification v1.0, v1.1, and v0.1*.

It specifies:

- System registers and behaviors for generation of MPAM information in processing elements, or PEs.
- Memory-mapped registers and standard types of resource control interfaces for Memory-System Components, or MSCs.
- Memory-mapped registers and resource usage monitors for measuring resource usage in MSCs.

Together, these facilities permit software both to observe memory-system usage and to allocate resources to software by running that software in a memory-system partition.

This document defines all versions of the MPAM Extension. For more information on MPAM Extension versions, see [Versions of the MPAM Extension on page 1-22](#).

This document primarily covers only the AArch64 Execution state, but the MPAM Extension does continue to operate in AArch32 state, as detailed in [MPAM AArch32 interoperability on page 6-84](#).

This document primarily describes hardware architecture. As such, it does not usually include information on either the software needed to control these facilities or the ways to implement effective controls of the memory system using the parameters defined by this architecture.

This document gives no guidance as to:

- Which optional features to implement in either a PE or an MSC.
- What resources in which MSCs should be controlled by MPAM.

Intended audience

This document targets the following audience:

- Hardware and software developers interested in the MPAM hardware architecture.

Using this book

This book is organized into the following chapters:

Chapter 1 *Introduction*

Read this chapter for an introduction to the MPAM extension.

Chapter 2 *MPAM and Arm Memory-System Architecture*

Read this chapter for a description of MPAM and Arm Memory-System Architecture.

Chapter 3 *ID Types, Properties, and Spaces*

Read this chapter for a description of ID Types, Properties, and Spaces.

Chapter 4 *Memory System Propagation of MPAM Information*

Read this chapter for a description of MSC Propagation of MPAM Information.

Chapter 5 *System Model*

Read this chapter for a description of the System model.

Chapter 6 *PE Generation of MPAM Information*

Read this chapter for a description of PE Generation of MPAM Information.

Chapter 7 *System Registers*

Read this chapter for a description of the System registers.

Chapter 8 *MPAM in MSCs*

Read this chapter for a description of MPAM in MSCs.

Chapter 9 *Resource Partitioning Controls*

Read this chapter for a description of Memory-System Partitioning.

Chapter 10 *Resource Monitors*

Read this chapter for a description of Performance Monitoring Groups.

Chapter 11 *Memory-mapped Registers*

Read this chapter for a description of Memory-Mapped Registers.

Chapter 12 *Errors in MSCs*

Read this chapter for a description of Errors in MSCs.

Chapter 13 *Pseudocode*

Read this chapter for the pseudocode function names that describe various features of the MPAM Architecture.

Appendix A *Generic Resource Controls*

Read this appendix for a description of Generic Resource Controls.

Appendix B *MSC Firmware Data*

Read this appendix for a description of MSC Firmware Data.

Glossary

Read this glossary for definitions of some of the terms that are used in this manual. The Arm Glossary does not contain terms that are industry standard unless the Arm meaning differs from the generally accepted meaning.

Note

Arm publishes a single glossary that relates to most Arm products, see the *Arm Glossary* through Arm Developer at <https://developer.arm.com/documentation/aeg0014/latest>. A definition in the glossary in this supplement might be more detailed than the corresponding definition in *Arm Glossary*.

How to read this book

Readers new to MPAM should first read Chapters 1 to 5.

Readers interested in MPAM generation behavior in the PE should read Chapters 6 and 7.

Readers interested in MPAM resource controls and memory-system component behaviors should read Chapters 8, 9, 11, 12, and Appendices A and B.

Readers interested in MPAM resource usage monitoring should read Chapters 8, 10, 11, and 12.

Readers interested in changes made by the Armv8.6 architecture extension should read sections mentioned in [Versions of the MPAM Extension on page 1-22](#).

Readers interested in MPAM pseudocode should read Chapter 13.

Readers interested in pseudocode and pseudocode definitions should read the *Arm® Architecture Reference Manual for A-profile architecture* (ARM DDI 0487).

Readers interested in Realm Management Extension, RME, should read the *Arm® Architecture Reference Manual Supplement, The Realm Management Extension (RME), for Armv9-A* (ARM DDI 0615).

Conventions

The following sections describe conventions that this book can use:

- [Typographic conventions](#).
- [Signals](#).
- [Numbers](#).
- [Pseudocode descriptions](#).

Typographic conventions

The typographical conventions are:

italic Introduces special terminology, and denotes citations.

bold Denotes signal names, and is used for terms in descriptive lists, where appropriate.

monospace Used for assembler syntax descriptions, pseudocode, and source code examples.
Also used in the main text for instruction mnemonics and for references to other items appearing in assembler syntax descriptions, pseudocode, and source code examples.

SMALL CAPITALS

Used for a few terms that have specific technical meanings, and are included in the Glossary LINK.

Colored text Indicates a link. This can be:

- A URL, for example, <http://developer.arm.com>
- A cross-reference, that includes the page number of the referenced information if it is not on the current page, for example, [Signals](#).
- A link to a chapter or appendix, or to a glossary entry, or to the section of the document that defines the colored term.

Signals

In general this specification does not define processor signals, but it does include some signal examples and recommendations.

The signal conventions are:

Signal level The level of an asserted signal depends on whether the signal is active-HIGH or active-LOW. Asserted means:

- HIGH for active-HIGH signals.
- LOW for active-LOW signals.

Lower-case n At the start or end of a signal name denotes an active-LOW signal.

Numbers

Numbers are normally written in decimal. Binary numbers are preceded by `0b`, and hexadecimal numbers by `0x`. In both cases, the prefix and the associated value are written in a monospace font, for example `0xFFFF0000`.

Pseudocode descriptions

This book uses a form of pseudocode to provide precise descriptions of the specified functionality. This pseudocode is written in a monospace font, and is described in [Chapter 13 Pseudocode](#).

Additional reading

This section lists relevant publications from Arm and third parties.

See Arm Developer, <https://developer.arm.com>, for access to Arm documentation.

Arm publications

This book contains information that is specific to this product. See the following documents for other relevant information:

- *Arm[®] Architecture Reference Manual for A-profile architecture* (ARM DDI 0487).
- *Arm[®] Architecture Reference Manual Supplement Armv9, for Armv9-A architecture profile* (ARM DDI 0608)
- *Arm[®] CoreSight Architecture Specification v2.0* (ARM IHI 0029).
- *ARM[®] Generic Interrupt Controller Architecture Specification, GIC architecture version 3.0 and version 4.0* (ARM IHI 0069).
- *Arm[®] Architecture Reference Manual Supplement, The Realm Management Extension (RME), for Armv9-A* (ARM DDI 0615).
- *Arm[®] System Memory Management Unit Architecture Specification, SMMU architecture version 3* (ARM IHI 0070).
- *The Realm Management Extension (RME), for SMMUv3 Arm[®] System Memory Management Unit Architecture Supplement* (ARM IHI 0094).

Other publications

The following book is referred to in this book:

- “*Heracles: Improving Resource Efficiency at Scale*” David Lo, Liqun Cheng, Rama Govindaraju, Parthasarathy Ranganathan, Christos Kozyrakis, 42nd Annual International Symposium on Computer Architecture (ISCA), New York NY, ACM, 2015.

Feedback

Arm welcomes feedback on its documentation.

Feedback on this book

If you have comments on the content of this book, send an e-mail to errata@arm.com. Give:

- The title, *Arm® Architecture Reference Manual Supplement Memory System Resource Partitioning and Monitoring (MPAM), for A-profile architecture*.
- The number, ARM DDI 0598D.a.
- The page numbers to which your comments apply.
- A concise explanation of your comments.

Arm also welcomes general suggestions for additions and improvements.

———— **Note** —————

Arm tests PDFs only in Adobe Acrobat and Acrobat Reader, and cannot guarantee the appearance or behavior of any document when viewed with any other PDF reader.

Progressive Terminology Commitment

Arm values inclusive communities. Arm recognizes that we and our industry have used terms that can be offensive. Arm strives to lead the industry and create change.

Previous issues of this document included terms that can be offensive. We have replaced these terms. If you find offensive terms in this document, please contact terms@arm.com.

Chapter 1

Introduction

This chapter contains the following sections:

- *Overview* on page 1-18.
- *Memory-system resource partitioning* on page 1-19.
- *Memory-system resource usage monitoring* on page 1-20.
- *Memory-system components* on page 1-21.
- *Versions of the MPAM Extension* on page 1-22.
- *Implementation flexibility* on page 1-30.
- *Example uses* on page 1-31.

1.1 Overview

Some shared-memory computer systems run multiple applications or multiple virtual machines (VMs) concurrently. Such systems may have one or more of the following needs:

- Control the performance effects of misbehaving software on the performance of other software.
- Bound the performance impact on some software by any other software.
- Minimize the performance impact of some software on other software.

These scenarios are common in enterprise networking and server systems. The Memory System Resource Partitioning and Monitoring (MPAM) extension addresses these scenarios with two approaches that work together, under software control, to apportion the performance-giving resources of the memory system. The apportionment can be used to align the division of memory-system performance between software, to match higher-level goals for dividing the performance of the system between software environments.

These approaches are:

- Memory-system resource partitioning.
- Memory-system resource usage monitoring.

The main motivation of the extension is to make data centers less expensive. The extension can increase server utilization, so that fewer servers are needed for a given level of service. Utilization can be increased by controlling how much impact the best-effort jobs have on the tail latency of responses by web-facing jobs. See “*Heracles: Improving Resource Efficiency at Scale*”.

This MPAM Extension describes:

- A mechanism for attaching partition identifiers and a monitoring property, for executing software on an Arm processing element (PE).
- Propagation of a Partition ID (PARTID) and Performance Monitoring Group (PMG) through the memory system.
- A framework for memory-system component (MSC) controls that partition one or more of the performance resources of the component. See [Memory-system components on page 1-21](#).
- Extension of the framework for MSCs to have performance monitoring that is sensitive to a combination of PARTID and PMG.
- Some implementation-independent, memory-mapped interfaces to memory-system component controls for performance resource controls most likely to be deployed in systems.
- Some implementation-independent memory-mapped interfaces to memory-system component resource monitoring that would likely be needed to monitor the partitioning of memory-system resources.

There are different versions of this MPAM Extension. For more information, see [Versions of the MPAM Extension on page 1-22](#).

1.2 Memory-system resource partitioning

The performance of programs running on a computer system is affected by the memory-system performance, which is in part controlled by several resources in the memory system. In a memory system shared by multiple VMs, OSs, and applications, the resources available to one software environment may vary, depending on which other programs are also running. This is true because those other programs may consume more or less of an uncontrolled memory-system resource.

Memory-system resource partitioning provides controls on the limits and use of previously uncontrolled memory-system resources.

Shared, partitionable memory-system resources that can affect performance of a VM, OS, or application include:

- Shared caches, in which one application may displace the cached data of another application.
- Interconnect bandwidth, in which use by one application can interfere with use by another application due to contention for buffers, communication links, or other interconnect resources.
- Memory bandwidth, in which use by one application can interfere with the use by another application due to contention for DRAM bus bandwidth.

This list is not exhaustive. MPAM functionality can be extended in future MPAM Extension specifications and through vendor and implementation-specific resource partitioning controls or resource-usage monitors.

Memory-system performance resource partitioning is performed by MPAM resource controls located within the MSCs. Each memory-system component may implement zero or more MPAM resource controls within that component.

An MPAM resource control uses the PARTID that is set for one or more software environments. A PARTID for the current software environment labels each memory system request. Each MPAM resource control has control settings for each PARTID. The PARTID in a request selects the control settings for that PARTID, which are then used to control the partitioning of the performance resources of that memory-system component.

1.3 Memory-system resource usage monitoring

Memory-system resource-usage monitoring measures memory-system resource usage. MSCs can have resource monitors. An MPAM monitor must be configured and enabled before it can be queried for resource-usage information. A monitor can be configured to be sensitive to a particular PARTID, or PARTID and PMG, and some monitors can be configured to certain subcategories of the resource (for example, the memory bandwidth used by writes that use a PARTID and PMG).

A monitor can measure resource usage or capacity usage, depending on the resource. For example, a cache can have monitors for cache storage that measure the usage of the cache by a PARTID and PMG.

Monitors can serve several purposes. A memory-system resource monitor might be used to find software environments to partition. Or, a monitor's reads might be used to tune the memory-system partitioning controls. A PMG value can be used to subdivide the software environments within a PARTID for finer-grained monitoring results, or to make measurements over prospective partitions.

1.4 Memory-system components

A Memory-System Component (MSC) is a function, unit, or design block in a memory system that can have partitionable resources. MSCs consist of all units that handle load or store requests issued by any MPAM Requester. These include cache memories, interconnects, Memory Management Units, memory channel controllers, queues, buffers, rate adaptors, and so on.

An MSC may be a part of another system component. For example, a PE may contain caches, which may contain MSCs.

1.5 Versions of the MPAM Extension

This document describes several versions of the MPAM architecture. The identification of architecture versions and the features present within a version differ between PEs and MSCs are described in:

- [MPAM versions for PEs.](#)
- [MPAM versions for MSCs.](#)
- [Relationships between MPAM versions on page 1-28.](#)
- [Interoperation of components with different MPAM versions on page 1-29.](#)

1.5.1 MPAM versions for PEs

There are multiple different versions of the MPAM Extension. The architecture version of the MPAM Extension implemented in a PE is given in ID_AA64PFR0_EL1.MPAM for the major version and ID_AA64PFR1_EL1.MPAM_frac for the minor version. [Table 1-1](#) shows how ID_AA64PFR0_EL1.MPAM and ID_AA64PFR1_EL1.MPAM_frac values indicate the MPAM architecture version.

Table 1-1 MPAM Extension implemented by a PE

ID_AA64PFR0_EL1.MPAM	ID_AA64PFR1_EL1.MPAM_frac	MPAM Extension Architecture version	Notes
0b0000	0b0000	None	MPAM is not implemented.
0b0000	0b0001	v0.1	MPAM v0.1 is implemented. MPAM v0.1 is the same as MPAM v1.1 with FORCE_NS which is incompatible with MPAM v1.0.
0b0001	0b0000	v1.0	MPAM v1.0 is implemented.
0b0001	0b0001	v1.1	MPAM v1.1 is implemented. MPAM v1.1 includes all features of MPAM v1.0. It must not include FORCE_NS.

The optional MPAM features and MPAM identifier sizes supported by a PE that supports a version of the MPAM Extension are indicated in the fields of [MPAMIDR_EL1](#).

1.5.2 MPAM versions for MSCs

The architecture version of the MPAM Extension implemented in an MSC is given in the MPAMF_AIDR register fields, ArchMajorRev and ArchMinorRev. The MPAM Extension versions used in MSCs are a subset of the versions used in PEs because the MPAM MSC architecture does not cover the generation of MPAM information by MSCs that are not PEs. The architecture of the component specifies how that component generates MPAM information for memory system requests that it originates.

MPAM Extension versions and the corresponding values of fields in MPAMF_AIDR of the MSC are shown in Table 1-2:

Table 1-2 MPAM version implemented by an MSC

MPAMF_AIDR		MPAM Extension version supported	MSC MPAM support
ArchMajor Rev	ArchMinor Rev		
0b0000	0b0000	None	The MSC does not implement MPAM.
0b0000	0b0001	N/A	Not a valid MPAM version for an MSC.
0b0001	0b0000	v1.0	The MSC implements MPAM v1.0 with features as described in the 32-bit MPAMF_IDR .
0b0001	0b0001	v1.1	The MSC implements MPAM v1.1 with features as described in the 64-bit MPAMF_IDR . MPAM v1.1 includes all of the MSC MPAM features of MPAM v1.0 plus additional MPAM features.

Most MPAM features in an MSC are optional. The particular MPAM features available in an MSC are described in the MSC's [MPAMF_IDR](#) register.

[MPAMF_IDR](#) is 32 bits in MPAM v1.0 and is 64 bits in MPAM v1.1.

[MPAMF_IDR](#) is permitted to have different MPAM features in different address spaces. If the MPAM feature RIS is implemented [MPAMF_IDR](#) is also permitted to have different features for different Resource Instances in an MSC.

MSCs can be used in MPAM v1.0 and v1.1, and in v0.1 under certain conditions. For more information on the conditions on use of MSCs in MPAM v0.1, see [MPAM versions in MSCs on page 8-164](#).

If an MSC does not implement any of the MPAM v1.1 MSC features listed in [MPAM versions for MSCs on page 1-22](#), then the MSC is of MPAM v1.0.

MSC of MPAM v1.1

The MPAM features that can be implemented in an MSC of MPAM v1.1 are:

Expansion of MPAMF_IDR

[MPAMF_IDR](#) is expanded to 64 bits to support bits that indicate the presence of features added from MPAM v1.1.

This feature is mandatory when the MSC implements MPAM v1.1.

This feature is implemented when [MPAMF_IDR.EXT](#) is set to 1.

For more information, see [MPAMF_IDR, MPAM Features Identification Register on page 11-237](#).

Capturing of IMPLEMENTATION DEFINED resource partitioning controls or resource monitoring

This feature defines two fields that allow discovery of any IMPLEMENTATION DEFINED resource partitioning controls or IMPLEMENTATION DEFINED resource monitors that are implemented.

This feature is mandatory when the MSC implements MPAM v1.1 and [MPAMF_IDR.HAS_IMPL_IDR](#) is 1.

This feature is implemented when [MPAMF_IDR.EXT](#) is 1. Furthermore:

- When [MPAMF_IDR.NO_IMPL_PART](#) is 1, [MPAMF_IMPL_IDR](#) does not include the description of any implementation-specific resource partitioning controls.
- When [MPAMF_IDR.NO_IMPL_MSMON](#) is 1, [MPAMF_IMPL_IDR](#) does not include the description of any implementation-specific resource monitors.

For more information, see [MPAMF_IDR, MPAM Features Identification Register](#) on page 11-237.

Resource instance selection

Resource instance selection, or RIS, provides access to the control settings of multiple resources of the same type within one MSC.

This feature is optional when the MSC implements MPAM v1.1.

This feature is implemented when [MPAMF_IDR.EXT](#) and [MPAMF_IDR.HAS_RIS](#) are 1.

For more information, see

- [Resource instance selection](#) on page 8-166.
- [MPAMCFG_PART_SEL, MPAM Partition Configuration Selection Register](#) on page 11-305.
- [MSMON_CFG_MON_SEL, MPAM Monitor Instance Selection Register](#) on page 11-332.
- [Error conditions in accessing memory-mapped registers](#) on page 12-393.

Greater range for MBWU monitors

This feature supports 44-bit and 63-bit memory bandwidth usage counters.

This feature is optional when the MSC implements MPAM v1.1.

This feature is implemented when [MPAMF_MBWUMON_IDR.HAS_LONG](#) is 1.

For more information, see [Long MBWU counter and capture](#) on page 10-206.

Discovery of MPAMF_ESR and MPAMF_ECR

This feature supports the [MPAMF_IDR.HAS_ESR](#) field. This field indicates whether [MPAMF_ESR](#) and [MPAMF_ECR](#) are implemented.

This feature is mandatory when the MSC implements MPAM v1.1.

This feature is implemented when [MPAMF_IDR.EXT](#) is 1.

For more information, see [MPAMF_IDR, MPAM Features Identification Register](#) on page 11-237.

Expansion of MPAMF_ESR

This feature widens [MPAMF_ESR](#) to 64 bits to include space for a RIS field.

This feature is optional when the MSC implements MPAM v1.1. Implementation of this feature is mandatory if [MPAMF_IDR.{HAS_ESR, HAS_RIS}](#) are 1.

This feature is implemented when [MPAMF_IDR.{EXT, HAS_EXTD_ESR}](#) are 1.

For more information, see

- [MPAMF_ESR, MPAM Error Status Register](#) on page 11-387
- [Resource instance selection](#) on page 8-166.

1.5.3 MPAM system features by MPAM version

MPAM System features are described in chapters 2 through 5 in this supplement, MPAM system features that vary by version are described in [Table 1-3](#):

Table 1-3 System features by MPAM version

MPAM feature	MPAM v0.1	MPAM v1.0	MPAM v1.1	MPAM for RME
MPAM_NS signal	Required	Required	Required	Prohibited
MPAM_SP signal	Prohibited	Prohibited	Prohibited	Required

1.5.4 MPAM PE features by MPAM version

The features applicable for different MPAM versions are described in chapters 6 and 7. These features are summarized in [Table 1-4](#):

Table 1-4 MPAM PE features by MPAM version

MPAM feature	MPAM v0.1	MPAM v1.0	MPAM v1.1	MPAM for RME	ID field
PARTID Virtualization	Optional	Optional	Optional	Optional	MPAMIDR_EL1.HAS_HCR
Force secure PARTID to NS	Required	Prohibited	Prohibited	Prohibited	MPAMIDR_EL1.HAS_FORCE_NS
Secure Default PARTID	Optional	Prohibited	Optional	Optional	MPAMIDR_EL1.HAS_SDEFLT
TIDR in MPAM2_EL2	Required	Prohibited	Required	Required	MPAMIDR_EL1.HAS_TIDR
Four PARTID Spaces	Prohibited	Prohibited	Prohibited	Required	MPAMIDR_EL1.SP4
Alternative PARTID spaces	Prohibited	Prohibited	Prohibited	Required	MPAMIDR_EL1.HAS_ALTSP

1.5.5 MSC features by MPAM version

MPAM MSC features are covered by chapters 8 through 12 of this supplement.

MPAM MSC features by MPAM version are shown in [Table 1-5](#):

Table 1-5 MSC features by MPAM version

MPAM feature	Subordinate feature	Subordinate feature 2	MPAM v1.0	MPAM v0.1/v1.1	MPAM for RME	ID field
Cache capacity partitioning			Optional	Optional	Optional	MPAMF_IDR.HAS_CCAP_PART
	Minimum cache capacity partitioning	-	Prohibited	Optional	Optional	MPAMF_CCAP_IDR.HAS_CMIN
	No maximum cache capacity partitioning	-	Prohibited	Optional	Optional	MPAMF_CCAP_IDR.NO_CMAX
	Cache maximum associativity partitioning	-	Prohibited	Optional	Optional	MPAMF_CCAP_IDR.HAS_CASSOC
	CMAX soft limit	-	Prohibited	Optional	Optional	MPAMF_CCAP_IDR.HAS_CMAX_SOFTLIM
Cache portion partitioning	-	-	Optional	Optional	Optional	MPAMF_IDR.HAS_CPOR_PART
PARTID disable			Prohibited	Optional	Optional	MPAMF_IDR.HAS_ENDIS
	No Future Use	-	Prohibited	Optional	Optional	MPAMF_IDR.HAS_NFU

Table 1-5 MSC features by MPAM version (continued)

MPAM feature	Subordinate feature	Subordinate feature 2	MPAM v1.0	MPAM v0.1/v1.1	MPAM for RME	ID field
Memory BW partitioning			Optional	Optional	Optional	MPAMF_IDR.HAS_MBW_PART
	Minimum BW partitioning	-	Optional	Optional	Optional	MPAMF_MBW_IDR.HAS_MIN
	Maximum BW partitioning	-	Optional	Optional	Optional	MPAMF_MBW_IDR.HAS_MAX
	BW portion partitioning	-	Optional	Optional	Optional	MPAMF_MBW_IDR.HAS_PBM
	Proportional BW partitioning	-	Optional	Optional	Optional	MPAMF_MBW_IDR.HAS_PROP
	BW window writable	-	Optional	Optional	Optional	MPAMF_MBW_IDR.WINDWR
Priority partitioning			Optional	Optional	Optional	MPAMF_IDR.HAS_PRI_PART
	Internal priority partitioning	-	Optional	Optional	Optional	MPAMF_PRI_IDR.HAS_INTPRI
	Downstream priority partitioning	-	Optional	Optional	Optional	MPAMF_PRI_IDR.HAS_DSPRI

Table 1-5 MSC features by MPAM version (continued)

MPAM feature	Subordinate feature	Subordinate feature 2	MPAM v1.0	MPAM v0.1/v1.1	MPAM for RME	ID field
Memory Sys resource monitoring			Optional	Optional	Optional	MPAMF_IDR.HAS_MSMON
	Cache storage usage monitoring	-	Optional	Optional	Optional	MPAMF_MSMON_IDR.MSMON_CSU
		CSU monitor capture	Optional	Optional	Optional	MPAMF_CSUMON_IDR.HAS_CAPTURE
		CSU monitor read-only	Optional	Optional	Optional	MPAMF_CSUMON_IDR.CSU_RO
		CSU monitor XCL	Prohibited	Optional	Optional	MPAMF_CSUMON_IDR.HAS_XCL
		CSU monitor overflow linkage	Prohibited	Optional	Optional	MPAMF_CSUMON_IDR.HAS_OFLOW_LNKG
		CSU monitor overflow status Reg	Prohibited	Optional	Optional	MPAMF_CSUMON_IDR.HAS_OFSR
		CSU monitor overflow capture	Prohibited	Optional	Optional	MPAMF_CSUMON_IDR.HAS_CEVT_OFLW
	Memory BW usage monitoring	-	Optional	Optional	Optional	MPAMF_MSMON_IDR.MSMON_MBWU
		MBWU monitor capture	Optional	Optional	Optional	MPAMF_MBWUMON_IDR.HAS_CAPTURE
		MBWU monitor Long	Optional	Optional	Optional	MPAMF_MBWUMON_IDR.HAS_LONG
		MBWU monitor R/W filtering	Optional	Optional	Optional	MPAMF_MBWUMON_IDR.HAS_RWBW
		MBWU monitor scaling	Optional	Optional	Optional	MPAMF_MBWUMON_IDR.SCALE
		MBWU monitor overflow linkage	Prohibited	Optional	Optional	MPAMF_MBWUMON_IDR.HAS_OFLOW_LNKG
MBWU monitor overflow status Reg		Prohibited	Optional	Optional	MPAMF_MBWUMON_IDR.HAS_OFSR	
MBWU monitor overflow capture		Prohibited	Optional	Optional	MPAMF_MBWUMON_IDR.HAS_CAPTURE	

Table 1-5 MSC features by MPAM version (continued)

MPAM feature	Subordinate feature	Subordinate feature 2	MPAM v1.0	MPAM v0.1/v1.1	MPAM for RME	ID field
	Monitor overflow status register	-	Prohibited	Optional	Optional	MPAMF_MSMON_IDR.HAS_OFLOW_SR
	Monitor overflow MSI	-	Prohibited	Optional	Optional	MPAMF_MSMON_IDR.HAS_OFLW_MSI
	No hardwired overflow interrupt	-	Prohibited	Optional	Optional	MPAMF_MSMON_IDR.NO_OFLW_INTR
	Local monitor capture event generator	-	Optional	Optional	Optional	MPAMF_MSMON_IDR.HAS_LOCAL_CAPT_EVNT
PARTID narrowing	-	-	Optional	Optional	Optional	MPAMF_IDR.HAS_PARTID_NRW
Implementation-defined ID Reg	-	-	Optional	Optional	Optional	MPAMF_IDR.HAS_IMPL_IDR
	Impl IDR no partitioning	-	Prohibited	Required	Required	MPAMF_IDR.NO_IMPL_PART
	Impl IDR no monitoring	-	Prohibited	Required	Required	MPAMF_IDR.NO_IMPL_MSMON
Extended ID register	-	-	Prohibited	Required	Required	MPAMF_IDR.EXT
Resource instance selector	-	-	Prohibited	Optional	Optional	MPAMF_IDR.HAS_RIS
Error status register			Prohibited	Optional	Optional	MPAMF_IDR.HAS_ESR
	Extended error status register	-	Prohibited	Optional	Optional	MPAMF_IDR.HAS_EXTD_ESR
Error MSI	-	-	Prohibited	Optional	Optional	MPAMF_IDR.HAS_ERR_MSI
Four PARTID spaces	-	-			Required	MPAMF_IDR.SP4

1.5.6 Relationships between MPAM versions

This section gives the relationships between MPAM versions.

MPAM v0.1

An MPAM v0.1 PE implements any permitted subset of the features of MPAM v1.1 and also implements [MPAM3_EL3.FORCE_NS](#). The [FORCE_NS](#) field cannot be present in any other MPAM version.

In a PE that implements MPAM v0.1, the MPAM features available (either Required or Optional) are described in [Table 1-4 on page 1-25](#).

For more information see [SDEFLT and FORCE_NS settings to control Secure MPAM PARTID use on page 6-76](#) and [MPAM3_EL3, MPAM3 Register \(EL3\) on page 7-114](#) for [FORCE_NS](#).

MPAM v1.0

MPAM v1.0 is the base version of MPAM. Unless explicitly defined, all features from MPAM v1.0 are present in the other versions of MPAM.

In a PE that implements MPAM v1.0, the MPAM features available (either Required or Optional) are described in [Table 1-4 on page 1-25](#).

In an MSC that implements MPAM v1.0, the MPAM features available (either Required or Optional) are described in [Table 1-5 on page 1-25](#).

MPAM v1.1

MPAM v1.1 adds features beyond the base version of MPAM. Unless explicitly removed, all features from MPAM v1.1 are present in MPAM v0.1 and in MPAM for RME.

In a PE that implements MPAM v1.1, the MPAM features available (either Required or Optional) are described in [Table 1-4 on page 1-25](#).

In an MSC that implements MPAM v1.1, the MPAM features available (either Required or Optional) are described in [Table 1-5 on page 1-25](#).

MPAM for RME

The MPAM for RME architecture supports the Realm Management Extension (RME) in systems, PEs and MSCs.

MPAM for RME requires MPAM v1.1 or higher.

In a PE that implements both RME and MPAM, MPAM for RME is required.

In a PE, MPAM for RME requires the MPAM feature ALTSP.

In a PE that implements MPAM for RME, the MPAM features available (either Required or Optional) are described in [Table 1-4 on page 1-25](#).

In an MSC that implements MPAM for RME, the MPAM features available (either Required or Optional) are described in [Table 1-5 on page 1-25](#).

An MPAM for RME implementation requires support for 4 PARTID spaces, see [MPAM for RME propagation of MPAM_SP with requests on page 4-48](#).

1.5.7 Interoperation of components with different MPAM versions

Hardware should not prevent PEs that implement different versions of the MPAM architecture to coexist within a system. However, PEs that implement different versions of the MPAM architecture might present a difficulty for software.

Hardware should not prevent MSCs that implement different versions of the MPAM architecture to coexist within a system.

There is no required relationship between the MPAM architecture version of a PE and the MPAM architecture version of an MSC accessed by that PE.

1.6 Implementation flexibility

Memory-system partitioning, monitoring capabilities, and certain implementation parameters must be discoverable by software, and they must be used by software to adapt to the system hardware. Discovery of MPAM memory-system component topology is expected to be by means of firmware data such as Device Tree or ACPI interface. MPAM controls and parameters of MSCs are discoverable in memory-mapped ID registers. Discovery of PE MPAM features and parameters is described in [Versions of the MPAM Extension on page 1-22](#).

The width of memory-system partitioning and monitoring values communicated through the system can be sized to the needs of the system. The costs can thereby be adjusted to meet the market requirements.

This document defines standard interfaces to some resource partitioning and monitoring features of MSCs. It does so by defining ID registers that expose implementation parameters and options. It also defines configuration registers that allow standard programming of these features while giving substantial implementation flexibility. In addition, this document also defines a mechanism that permits IMPLEMENTATION DEFINED partitioning and monitoring features that may introduce partitioning or monitoring in new ways or of new resource types.

1.7 Example uses

This section is *informative*. It presents examples of partitioning uses that reduce memory-system interactions.

1.7.1 Separate systems combined

With faster processors, it is often less expensive to integrate into a single computer system the functions previously performed by two or more systems. If any of these previously separate systems was real-time or otherwise performance-sensitive, it may be necessary to isolate the performance of that function from others in the integrated system.

Memory system performance can be monitored, and the measured usage can guide optimization of system partitioning.

Partitioning is often statically determined by the system developer. Partitions may be given non-shared resource allocations to improve real-time predictability. The number of partitions required could be small, similar to the number of previously separate systems.

1.7.2 Foreground and background job optimization

When foreground and background jobs are run on the same system, the foreground job's response time should not be compromised, and the background job's throughput should be optimized. The performance of the foreground and background jobs can be monitored, and the resource allocations can be changed dynamically to track system loading while optimizing foreground response time and background throughput.

An example of this approach is proposed in *Heracles: Improving Resource Efficiency at Scale*. This paper describes a system that requires only two partitions, one for web-facing applications and another for best-effort applications. The Heracles approach measures the service-level objective of tail latency for web service and adjusts the division of resources between the two partitions. Resource-usage monitoring is also used to tune resource allocation for particular resources.

1.7.3 Service-level provisioning in multi-tenant VM servers

When a server runs multiple VMs for different users, it is necessary to prevent one VM from using more resource than it has paid for and thereby prevent other tenants from being able to use the resource they have paid for. MPAM partitions provide a means to regulate the memory-system resources used by a VM.

While there need only be a few service levels provisioned onto a server, each VM needs a separate PARTID so that resource-usage controls can be separately responsive to the resource demands of that VM.

Chapter 2

MPAM and Arm Memory-System Architecture

This chapter contains the section:

- [Overview on page 2-34.](#)

2.1 Overview

This section is *informative*.

MPAM partitioning of memory-system performance resources must not affect the correctness of any memory behavior specified in the *Arm® Architecture Reference Manual for A-profile architecture*. The Armv8-A memory model, as specified in that manual, must be followed in all of its particulars, including requirements for observation, coherence, caching, order, atomicity, endianness, alignment, memory types, and any other requirements defined in the Armv8-A memory model. Furthermore, these requirements must also be met:

- For single-PE and multiple-PE environments.
- When the MPAM information in multiple requests to an MSC are the same or are different, and whether those multiple requests come from a single requestor or from multiple requestors.
- For all MPAM memory-system component resource controls and configurations.
- When MPAM information stored with data accessed from caches is the same as, or different from, MPAM information in requests that access that data.

A Speculative access (either an instruction prefetch or an early data read) may be generated at any time, based on MPAM System register configuration that might change before the access would be architecturally executed. MPAM does not impose any limit on such speculation – neither a data dependency on the MPAMn_ELx registers nor a control dependency on the System register synchronization, other than the limits on use of System register values in the *Arm® Architecture Reference Manual for A-profile architecture*.

Chapter 3

ID Types, Properties, and Spaces

This chapter contains the following sections:

- *Introduction on page 3-36.*
- *ID types and properties on page 3-37.*
- *Physical address spaces on page 3-38.*
- *PARTID spaces and properties on page 3-39.*

3.1 Introduction

This chapter is *normative*.

MPAM operation is based on the MPAM information that Requesters include with requests made to the memory system. This chapter defines the components of that MPAM information bundle, which consists of:

- PARTID.
- PMG.
- MPAM_NS or MPAM_SP.

3.2 ID types and properties

MPAM has a single ID type, the Partition ID or PARTID. The architectural maximum width of a PARTID field is 16 bits.

PARTIDs have a single property. This is the Performance Monitoring Group, or PMG. The architectural maximum width of a PMG field is 8 bits.

3.3 Physical address spaces

The Armv8-A architecture defines two physical address spaces:

- Non-secure physical address space.
- Secure physical address space.

RME provides two additional physical address spaces:

- Realm physical address space.
- Root physical address space.

MPAM makes use of the physical address spaces to access the resource control settings in memory system components. The controls for each PARTID space are accessed in the physical address space associated with that PARTID space.

Table 3-1 Physical address spaces to access MSC control settings for PARTID spaces

Physical address space	Access to control settings for PARTID space
Non-secure physical address space	Non-secure PARTID space
Secure physical address space	Secure PARTID space
Realm physical address space	Realm PARTID space
Root physical address space	Root PARTID space

3.4 PARTID spaces and properties

MPAM uses two PARTID spaces to label memory system requests:

- Secure physical PARTID space. This space is accessed when a Requester is executing in a Secure state.
- Non-secure physical PARTID space. This space is accessed when a Requester is executing in a Non-secure state.

PEs and some other Requesters have optional virtual PARTID spaces:

- Non-secure virtual PARTID space. This space exists only when the PE has the MPAM virtualization option implemented and enabled for the current EL.
- Secure virtual PARTID space. This space exists only when the PE has the MPAM virtualization option implemented and enabled for the current EL.

MPAM for RME provides two additional PARTID spaces:

- Realm physical and virtual PARTID spaces.
- Root physical and virtual PARTID spaces.

The PARTID spaces are parallel to the physical address spaces, but the PARTID space is not determined by the physical address space of an access. The PARTID space is determined by the Security state from which a memory access is made. Other factors, such as translation configuration, affect the physical address space of a memory access.

Table 3-2 Primary PARTID space for each Exception level and Security state in RME

Security state	EL3	EL2	EL1	EL0
Non-secure	n/a	Non-secure PARTID space	Non-secure PARTID space	Non-secure PARTID space
Secure	n/a	Secure PARTID space	Secure PARTID space	Secure PARTID space
Realm	n/a	Realm PARTID space	Realm PARTID space	Realm PARTID space
Root	Root PARTID space	n/a	n/a	n/a

———— **Note** —————

The primary PARTID space is determined only by the Security state and the Exception level.

Except for Non-secure state, if the PE supports the PARTID space MPAM feature, an alternative PARTID space can be made available for software to use. See [Alternative PARTID spaces and selection on page 6-90](#).

MPAM_NS indicates the PARTID space of a physical PARTID. When MPAM_NS is 0 it indicates the Secure physical PARTID space. When MPAM_NS is 1 it indicates the Non-secure physical PARTID space.

For RME, the MPAM_NS component of the MPAM information bundle is redefined to be a 2-bit value, MPAM_SP. The value of MPAM_SP[1:0] is given in [Table 3-3](#).

Table 3-3 : Encoding of 2-bit MPAM_SP

MPAM_SP[1:0]	MPAM PARTID space
0b00	Secure PARTID space
0b01	Non-secure PARTID space
0b10	Root PARTID space
0b11	Realm PARTID space

Each PARTID space has a maximum PARTID set by the implementation. The range of valid PARTIDs is 0 to the maximum PARTID, inclusive. The maximum values of a PARTID implemented by a PE and by different MSCs need not be the same. Software should avoid using PARTIDs that exceed the smallest maximum of any MSCs accessed, because the behavior of an MSC accessed with an out-of-range PARTID is not well-defined.

Each MSC has an MPAM identification register with which to discover the maximum PARTID implemented in each physical PARTID space. The maximum Non-secure PARTID supported by an MSC is indicated in its MPAMF_IDR.PARTID_MAX. The maximum Secure PARTID supported by an MSC is indicated in its MPAMF_SIDR.PARTID_MAX.

The maximum PARTID supported by a PE is indicated in MPAMIDR_EL1.PARTID_MAX.

3.4.1 Default PARTID

Each MPAM PARTID space has a default value, which is PARTID 0 in that PARTID space.

The default physical PARTID must be generated when MPAM PARTID generation is disabled by $MPAMn_ELn.MPAMEN == 0$, where n is the highest Exception level implemented.

The PARTID space of a default PARTID is selected according to the current Security state. It is always the primary PARTID space for the Security state unless either the FORCE_NS MPAM feature or the alternative PARTID space MPAM feature is implemented.

In MPAM v0.1 only, if the FORCE_NS feature is implemented, MPAM3_EL3.FORCE_NS is 1 and the primary PARTID space is the Secure PARTID space, the Non-secure PARTID space is used.

If FEAT_RME and the alternative PARTID space features are implemented, the selection of the primary or alternative PARTID space chooses the PARTID space to use. This is in conjunction with some controls over the alternative PARTID space used for Secure Security state and for Realm Security state by fields in MPAM3_EL3. See [Alternative PARTID spaces and selection on page 6-90](#).

MPAM PARTID generation is permitted to produce the default PARTID when the generation encounters an error.

The PARTID error conditions in a PE are described in [MPAM errors and default ID generation on page 6-88](#).

———— **Note** —————

System designers can choose to output the default IDs on requests generated by Requesters that do not support MPAM.

—————

3.4.2 Default PMG

The default PMG must be generated when $MPAMEN == 0$.

It is CONSTRAINED UNPREDICTABLE whether MPAM PMG generation produces the PMG value from the MPAMn_ELx register field or the default PMG in each of two cases:

- When the PMG generation encounters an error, such as out-of-range PMG.
- When a default PARTID is generated due to a PARTID generation error.

In other cases, when $MPAMEN == 1$, the PMG must be the PMG value from the MPAMn_ELx register field.

The PMG error conditions in a PE are described in [MPAM errors and default ID generation on page 6-88](#).

———— **Note** —————

System designers can choose to output the default IDs on requests generated by Requesters that do not support MPAM.

—————

Chapter 4

Memory System Propagation of MPAM Information

This chapter contains the following sections:

- *Introduction* on page 4-42.
- *Requester components* on page 4-43.
- *Terminating Completer components* on page 4-44.
- *Intermediate Completer-Requester components* on page 4-45.
- *Request buffering* on page 4-46.
- *Cache memory* on page 4-47.

4.1 Introduction

This section is *normative*.

The MPAM information bundle is propagated through the memory system components, or MSCs, that have MPAM resource controls or monitoring. The MPAM information bundle is described in [Introduction on page 3-36](#).

MPAM information propagates in the direction of requests from Requesters towards terminating Completer components. This is the downstream direction. The upstream direction is from Completers towards Requesters.

The propagation behavior in the memory system depends on the function of the part of the memory system. Each MSC must implement at least one of the following behaviors:

- [Requester components on page 4-43](#).
- [Terminating Completer components on page 4-44](#).
- [Intermediate Completer-Requester components on page 4-45](#).
- [Request buffering on page 4-46](#).
- [Cache memory on page 4-47](#).
- [MPAM for RME propagation of MPAM_SP with requests on page 4-48](#).

If an MSC has no downstream components that use MPAM information, the MSC is not required to propagate MPAM information.

4.2 Requester components

Requesters must label all requests to downstream MSCs with MPAM information.

A Requester must have a device-appropriate means of setting the MPAM information in the request:

- The PE must use the scheme described in [Chapter 6 PE Generation of MPAM Information](#).
- This architecture does not specify a mechanism for determining the MPAM information for requests from a non-PE Requester. Arm recommends that non-PE Requesters needing to use MPAM facilities specify a mechanism for determining the PARTID, PMG, and MPAM_NS of requests.
- *Arm System Memory Management Unit Architecture Specification, SMMU architecture versions 3.0, 3.1 and 3.2* specifies MPAM information generation on memory system accesses translated by the SMMU and accesses originated by the SMMU to its tables in memory.
- *Arm Generic Interrupt Controller Architecture Specification, GIC architecture version 3.0 and version 4.0* specifies MPAM information generation on memory system accesses originated by the GIC to its tables in memory.

If a Requester does not support MPAM, the system must arrange to supply a value for MPAM information required for the interface. If no other mechanism is available, then these values must be driven to a default value, whether they are in the Non-secure physical PARTID space, the Secure physical PARTID space, the Root PARTID space or the Realm PARTID space.

See also [Requesters without MPAM support](#) on page 5-55.

4.3 Terminating Completer components

A terminating Completer receives requests from upstream Requesters but does not communicate the requests to a downstream Completer. Instead, the terminating Completer services the requests. A terminating Completer does not forward MPAM information from a request. A terminating MSC is the edge of MPAM in a system.

A DRAM controller is a terminating Completer, even though it communicates with DRAM devices to complete the request. The DRAM devices do not support MPAM communication, so MPAM information is not forwarded to them. This might also happen elsewhere in a system where there is no downstream Completer that has MPAM support.

4.4 Intermediate Completer-Requester components

Intermediate MSCs have both one or more Completer interfaces and one or more Requester interfaces.

An intermediate component can route a request from an upstream Requester to one of its downstream Requester ports. When routing a request from upstream to downstream, the intermediate component passes the MPAM information unaltered to the downstream Requester port.

An intermediate component might terminate some requests from upstream locally without propagating the request to a downstream Requester port if the request is serviced locally.

4.5 Request buffering

Requests can be buffered in any MSC. A request that is buffered must retain its MPAM information.

4.6 Cache memory

A cache line must store the MPAM information of the request that caused its allocation. See [Cache behavior on page 5-58](#) for requirements on cache memory behavior.

4.7 MPAM for RME propagation of MPAM_SP with requests

MPAM_SP is 2 bits in an MPAM for RME four-PARTID-space region. See [Four-space region on page 5-61](#).

MPAM_SP must be propagated to all components within a four-space region.

MPAM_SP must be propagated to all bridges connecting a four-space region to a two-space region. See [Two-space region on page 5-61](#) and [Systems with both two PARTID space and four PARTID space components on page 5-61](#).

MPAM_SP must be propagated from all bridges connecting two-space regions to a four-space region.

Chapter 5

System Model

This chapter contains the following sections:

- *Introduction* on page 5-50.
- *System-level field widths* on page 5-52.
- *PE behavior* on page 5-53.
- *Other Requesters with MPAM* on page 5-54.
- *Requesters without MPAM support* on page 5-55.
- *Model of a resource partitioning control* on page 5-56.
- *Interconnect behavior* on page 5-57.
- *Cache behavior* on page 5-58.
- *Memory-channel controller behavior* on page 5-60.
- *The MPAM for RME system* on page 5-61.

5.1 Introduction

This section describes a model of system behavior that can support the MPAM features. In particular, the behavior of Requesters, interconnects, caches, and memory controllers is described.

In this system model, a request:

- Begins at a Requester, such as a PE, I/O Requester, DMA controller, or graphics processor:
 - MPAM information (PARTID, PMG, and MPAM_NS) is transported with every request.
- Traverses non-cache nodes that might be a transport component (such as an interconnect), a bus resizer, or an asynchronous bridge.
- Might reach an MSC that contains or is a cache:
 - Caches sometimes generate a response (cache hit) and sometimes pass the request on (cache miss).
 - Caches could also allocate entries based on the request.
 - Caches must store the MPAM PARTID, PMG, and MPAM_NS associated with an allocation:
 - Needed for cache-storage usage monitoring.
 - Used during eviction to another cache.
 - Cache eviction must attach MPAM fields to the eviction request. The source for MPAM information on an eviction may depend on whether the eviction is to memory or to another cache. See [Eviction on page 5-58](#) and [Optional cache behaviors on page 5-59](#).
- Might proceed from a cache to a transport component, and to other caches or a memory-channel controller.
- Might result in a memory controller or other terminating Completer device responding to a request it receives.

[Figure 5-1 on page 5-51](#) shows a simplified system model for the downstream flow, in the direction of requests from Requesters to Completers. In this figure, all objects implement an MSC except the PEs, I/O Requesters, and I/O Completers. PEs generate MPAM information from MPAM state in their System registers. I/O Requesters typically get their MPAM information when their requests pass through an SMMU.

The interconnects in [Figure 5-1 on page 5-51](#) can represent bus, crossbar, packet, or other interconnect technologies.

An MSC responds to the MPAM information that arrives as part of a request. If the MSC implements partitioning controls, those controls find partitioning settings by the PARTID in the MPAM information of the request, and they use those settings to control the allocation of a controlled resource.

For caches, a cache line (which has an address) is always associated with the PARTID that allocated the line – or the PARTID that allocated the line into an inner cache that has now been evicted to the current cache. The inner cache PARTID must be preserved when the line is evicted to an outer cache.

An address may be accessed by multiple PARTIDs.

A cache must store the PARTIDs of the lines it contains, so that it can measure and control the cache lines used by a PARTID, and so that it can provide the PARTID to downstream MSCs when the line is evicted.

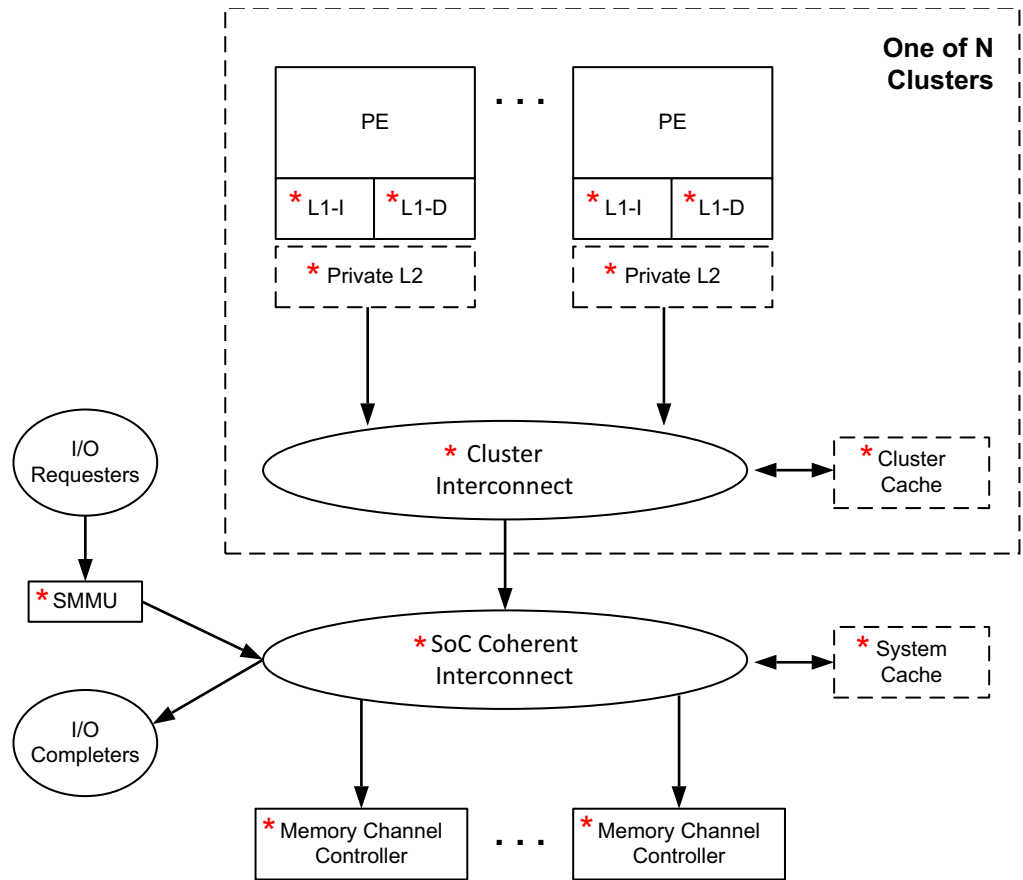

* Memory-System Component (MSC) that might contain MPAM resource controls

Figure 5-1 MPAM system model (downstream flow)

5.2 System-level field widths

Arm recommends that a system be configured to support a common size for the PARTID and PMG fields of MPAM. Mismatched sizes make it difficult for software to use anything but the smallest of implemented widths.

5.3 PE behavior

Processing elements (PEs) issue memory-system requests. PEs must implement the MPAMn_ELx registers (page 7-95) and their behaviors to generate the PARTID and PMG fields of memory-system requests.

See [Chapter 6 PE Generation of MPAM Information](#).

5.3.1 PARTID generation

When a PE generates a memory-system request, it must label the request with the PARTID from the MPAMn_ELx register for the current Exception level. MPAM_NS must be set to the current execution Security state.

If the MPAM Virtualization Extension is implemented and enabled for the current Exception level, the PARTID from the MPAMn_ELx register must be mapped through the virtual partition mapping registers ([System register descriptions on page 7-99](#)) to produce a physical PARTID.

5.3.2 Information flow

When a PE with MPAM support issues a request to the rest of the system, it labels those commands with the PARTID and PMG supplied by software in the MPAMn_ELx register in effect (and if MPAM1_EL1 or MPAM0_EL1 with virtual PARTID mapping is enabled, with the virtual PARTID mapped to a physical PARTID).

In addition to the PARTID and PMG, the request must also have the MPAM_NS bit to indicate whether the PARTID is to be interpreted as in the Secure PARTID space or the Non-secure PARTID space.

When FEAT_RME is implemented, Root and Realm PARTID spaces are also available. In this case the MPAM_SP bit is used to indicate whether the PARTID is to be interpreted as in the Secure PARTID space, Non-secure PARTID space, Root PARTID space or Realm PARTID space. See [PARTID spaces and properties on page 3-39](#).

5.3.3 Resource partitioning

If a PE contains internal memory-system partitioning controls, it must have memory-mapped registers ([Chapter 9 Resource Partitioning Controls](#)) to identify and configure those features.

The PE could include caches. The included caches could implement memory-system partitioning, such as cache-capacity partitioning controls. The cache behavior in [Cache behavior on page 5-58](#) must apply to included cache functionality.

An MSC within a PE could have priority partitioning. This generates a priority or QoS value for the downstream traffic from that MSC, effectively giving priority or QoS values tied to the software environment that generated that traffic.

5.3.4 Resource-usage monitoring

A PE may have internal resource monitors that can measure the use by a PARTID and PMG of an MPAM resource ([Chapter 10 Resource Monitors](#)).

If a PE contains such features, they must have memory-mapped registers ([Chapter 10 Resource Monitors](#)) to identify and configure those features.

5.4 Other Requesters with MPAM

Other Requesters that support MPAM, such as a DMA controller, must issue requests to the system that have the MPAM fields. Non-PE Requesters can have schemes different from those implemented in PEs for associating MPAM information with requests. These other schemes are not documented herein.

5.5 Requesters without MPAM support

A Requester that does not implement support for MPAM must use a system-specific means to provide MPAM information to MSCs that support MPAM.

Some examples of Requester devices that might not implement support for MPAM include:

- Legacy DMA controller.
- Third-party peripheral IP.
- CoreSight DMA components, such as ETR.
- Older devices which cannot be economically upgraded to include MPAM support.

Some options for adding MPAM information to requests include:

- The MPAM information could be tied off to the default PARTID and PMG values ([Default PARTID on page 3-40](#)) and MPAM_NS set as appropriate for the device.
- The MPAM information could be provided by a System Memory Management Unit (SMMU) that supports adding MPAM information according to the stream and substream of the request.
- The MPAM information could be added by a bus bridge or other system component that handles the Requester's memory-system traffic.

Other implementations are permitted.

5.6 Model of a resource partitioning control

A general model of a resource partitioning controller within an MSC is shown in [Figure 5-2](#). This model shows a resource partitioning model that measures resource usage by the partition and that controls resource usage by comparing the measured usage with the control settings for that partition.

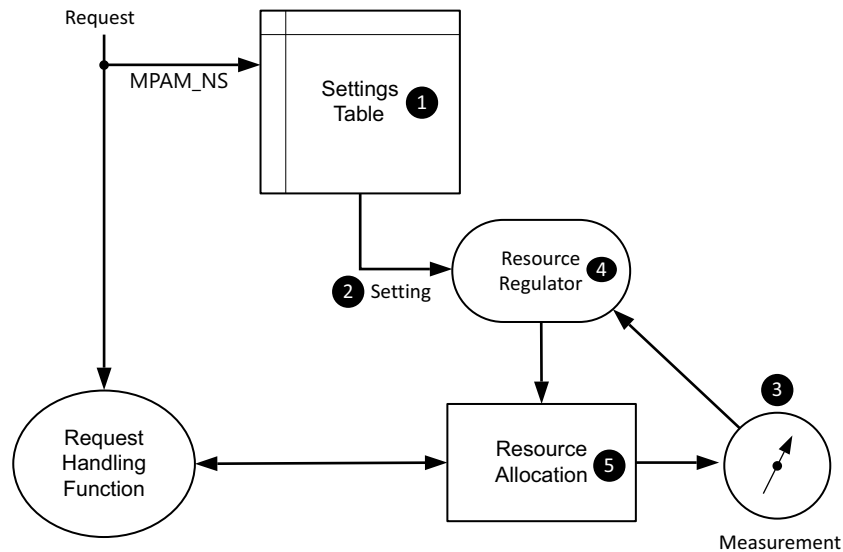

Figure 5-2 Model of MPAM resource partitioning controller

In [Figure 5-2](#), a request arrives from an upstream Requester to an MSC that implements MPAM partitioning control. The request is handled as follows:

1. The PARTID and MPAM_NS values of the incoming request are used to index into a Settings Table of partition-control settings. (There is one settings table per implemented resource control.)
2. The table entry for that PARTID specifies its partition-control setting, which is passed to a Resource Regulator.
3. Conformance of the resource with the setting may require Measurement of how the resource is being used by the partition.
4. The Measurement feeds back to the Resource Regulator, where it is compared with the Setting and used to make a decision about Resource Allocation.

In [Figure 5-2](#), items 1, 2, 3, and 4 are added to the original memory system when MPAM is implemented, although in some MSCs there may be sufficient measurement hardware already in place. Item 1, the Settings Table, is the heart of an MPAM MSC.

All of the above is separate from normal request-handling by the MSC.

When doing cache-way partitioning, a significant part of the above mechanism can be eliminated. It is not necessary to make measurements. The cache ways that can be allocated into are known.

The upside of cache-way partitioning is that it is simple and cheap. The downside is that caches do not have many ways, so fine-grained control is not possible. In addition, resources can be strained if one or more ways are allocated to only one partition, without sharing.

5.7 Interconnect behavior

Interconnects connect Requesters to Completers, and they must transport MPAM information fields from Requester to Completer.

Interconnects may support the MPAM control features, such as priority partitioning. Support for MPAM is discoverable in ID registers and firmware data.

Some interconnect devices may include cache functionality, in which case the cache behavior in [Cache behavior on page 5-58](#) applies.

5.8 Cache behavior

A cache must associate the MPAM information of the request that allocated a cache line with any data stored in the cache line. This stored MPAM information is a property of the data.

The term “data” in this section is intended to indicate the content stored in the cache. It is not intended to indicate any restriction on the applicability of this section based on the purpose of the cache or of its content.

The MPAM information on a request to the cache from an upstream Requester is used for the following purposes:

- Source for the MPAM information associated with data when the data is allocated into the cache and is stored in association with the data while the data resides in the cache.
- Optionally updating the stored MPAM information of the cached data on a store hit (*Write hits may update the MPAM information of a cache line on page 5-59*).
- Providing MPAM information for downstream requests to fulfill the incoming request such as a read from downstream on a cache miss that fetches data into the cache.
- Optionally (*Eviction*), providing MPAM information for downstream requests generated by evict or clean operations when this cache is the last level of cache upstream of main memory.
- Selecting settings of partitioning controls implemented in the cache.
- Tracking resource usage needed by partitions for a control implementation.
- Performing accounting, if necessary, to track resource usage for resource usage monitors, if implemented.
- Triggering and filtering resource monitors, if implemented, for events triggered by requests from upstream Requesters.

The stored MPAM information is used by MPAM for the following purposes:

- Providing the MPAM information for downstream requests generated by evict or clean operations, when this cache is not the last level of cache.
- Optionally (*Eviction*) providing MPAM information for downstream requests generated by evict or clean operations, when this cache is the last level of cache.
- Triggering and filtering resource monitors by MPAM PARTID and PMG, if implemented for events triggered by internal and downstream requests.
- Tracking resource usage by partitions, as needed by a partitioning control implementation.

5.8.1 Eviction

When a cache line is evicted to another cache, the evicting cache must produce the MPAM information that was used in the request that originally allocated the cache line.

A system cache (last-level cache) may produce the MPAM information of the request that caused the eviction in its request to a memory-channel controller, or the cache may produce the stored MPAM information associated with the evicted line.

5.8.2 Cache partitioning

A cache may optionally implement cache-partitioning resource controls, such as a cache-portion partitioning control.

The cache-portion partitioning control (*Cache-portion partitioning on page 9-186*) was conceived for use on large, multi-way associative caches, but cache-portion partitioning can be implemented on caches that are not set-associative. For example, a single entry or group of entries may be a cache portion in a fully-associative cache.

The cache maximum-capacity partitioning control (*Cache maximum-capacity partitioning on page 9-188*) was conceived for use on caches that do not support cache-portion partitioning or that have insufficient portions to meet the needs of the planned use.

Both types of cache partitioning may be used together in a cache memory component. This may be useful, for example, when the cache has insufficient portions to give adequate control for a planned use.

5.8.3 Resource monitoring

A cache may implement cache-storage usage monitoring (*Cache-storage usage monitors on page 10-207*). For a monitored PARTID, the monitor gives the total cache storage used by the PARTID.

5.8.4 Optional cache behaviors

The following cache behaviors are permitted but not required.

Write hits may update the MPAM information of a cache line

On a write hit to cached data that has different request MPAM information than the stored MPAM information associated with the data, the stored MPAM information is permitted to be updated to the request MPAM information.

It is possible that a change in the PART_ID of the data (without moving the data) leaves the data in a portion of the cache that the new PARTID does not have permission to allocate. This can occur if the Cache Portion Bit Map (CPBM) bit for that portion is not set in the CPBM for the new PARTID. The optional behavior in this subsection does not change the location within the cache, even if the new partition for the data does not have a CPBM bit that allows allocation in this portion of the cache. Updating the location within the cache is a second optional behavior that is covered in the next subsection.

Write hits that update the PARTID of a cache line may move that line to a different portion

A write hit to cached data is permitted to change the portion of the cache capacity allocated to the data, if (i) the PARTID of the cache data is updated due to the write hit, and (ii) the portion of capacity where the data currently resides is not in the new PARTID's cache portion bitmap.

5.9 Memory-channel controller behavior

This section is informative.

A memory-channel controller may implement MPAM features. Some of the features that may be helpful in a memory-channel controller are:

- Memory-bandwidth minimum and maximum partitioning (*Memory-bandwidth minimum and maximum partitioning on page 9-190*).
- Memory-bandwidth portion partitioning (*Memory-bandwidth portion partitioning on page 9-190*).
- Priority partitioning (internal) (*Priority partitioning on page 9-194*).
- Memory-bandwidth usage monitors (*Memory-bandwidth usage monitors on page 10-205*).

5.10 The MPAM for RME system

5.10.1 The MPAM for RME system

The MPAM for RME system supports RME PEs and at least one PE that supports both RME and MPAM for RME.

RME PEs support:

- Four Security states.
- Four physical address spaces.

A PE that supports RME and MPAM must also support MPAM for RME.

MPAM for RME requires support in the PE for:

- MPAM v1.1.
- Four MPAM PARTID spaces.
- MPAM *alternative space*, ALTSP feature.

There are two possible space regions in an MPAM for RME system:

- A four-space region.
- A two-space region.

Like other MPAM systems, MPAM for RME can also contain non-MPAM components and subsystems. See [Non-MPAM components on page 5-66](#).

Four-space region

This type of region:

- Contains one or more RME application PEs.
- Contains caches associated with those PEs.
- Contains cache-coherent interconnect among those PEs.
- Supports four MPAM PARTID spaces.

All components in a four-space region must support and use four PARTID spaces. If a component that can support four PARTID spaces is in a two-space region, then only those two PARTID spaces can be used.

Two-space region

This type of region contains a single two-space MPAM component or many two-space MPAM components connected as a subsystem through a two-space interconnect component. This component connects to the four-space region using a bridging scheme.

Two-space MPAM components support two PARTID spaces. These are compatible with MPAM v1.0 and MPAM v1.1 but lack support for the Root and Realm PARTID spaces.

Two-space MPAM components can be used in an MPAM for RME system, but with some loss of functionality and with some complication to the MPAM software.

Systems with both two PARTID space and four PARTID space components

When two-space MPAM components are included in a four PARTID space system, all four-space MPAM components receive requests from any four PARTID space Requesters with all four states propagated to the four-space components.

If the propagation of the four PARTID spaces in the MPAM information labels is blocked by two-space components between any four-space Requester and any four-space Completers, the interface where the four PARTID spaces are reduced to two PARTID spaces is the boundary to a two-space region and must reduce the MPAM_SP to MPAM_NS using a bridge. The Completer is part of a two-space region and uses only two PARTID spaces even though it supports four.

Figure 5-3 shows a system with a large four-space region with support for four PARTID spaces and a smaller two-space region. The boxes labeled 2 to 4 and 4 to 2 are bridges chosen from *Bridging between four-space and two-space regions* on page 5-63.

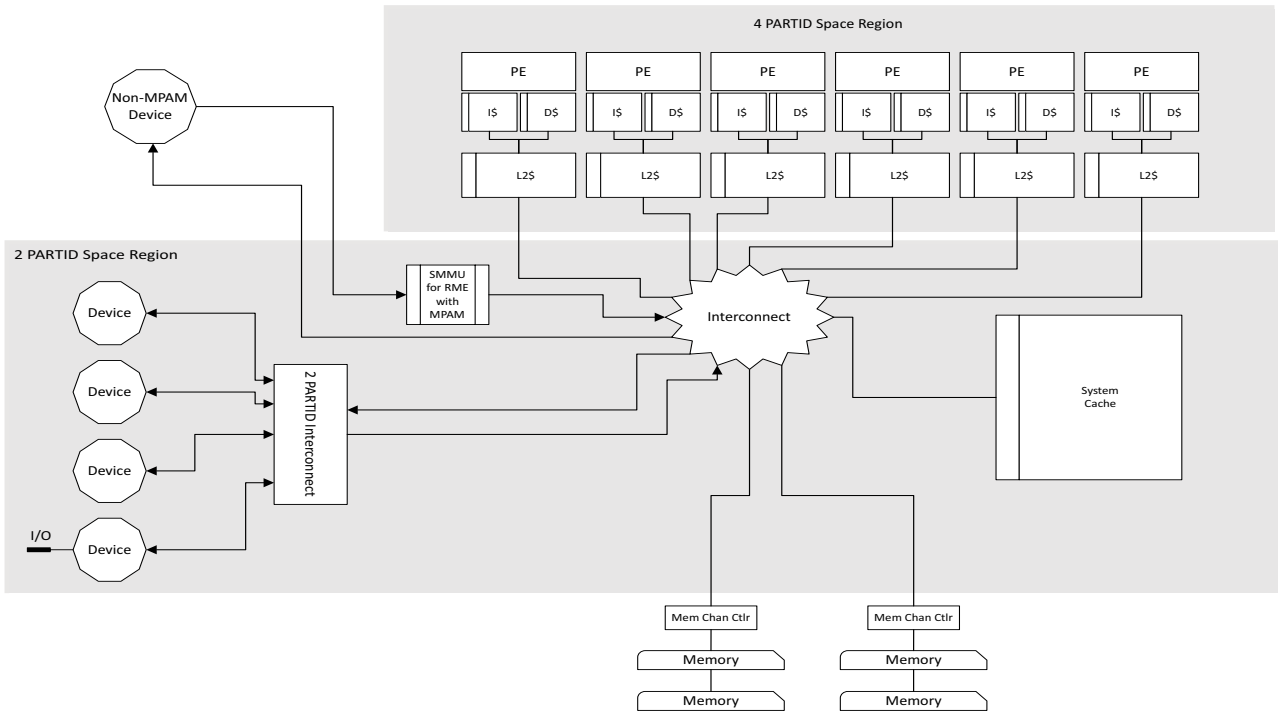

Figure 5-3 Example system with a large four PARTID space region and small two PARTID space regions

Figure 5-4 on page 5-63 shows a system with a small four-space region and a large two-space region. In this case the bridges are not shown. Here the PEs can use the ALTSP feature to produce two PARTID space requests without the need for bridging logic, using just the static bridge of the Completer. See *Alternative PARTID space and PARTID virtualization* on page 6-92 and *Fixed space mapping at a Completer* on page 5-66.

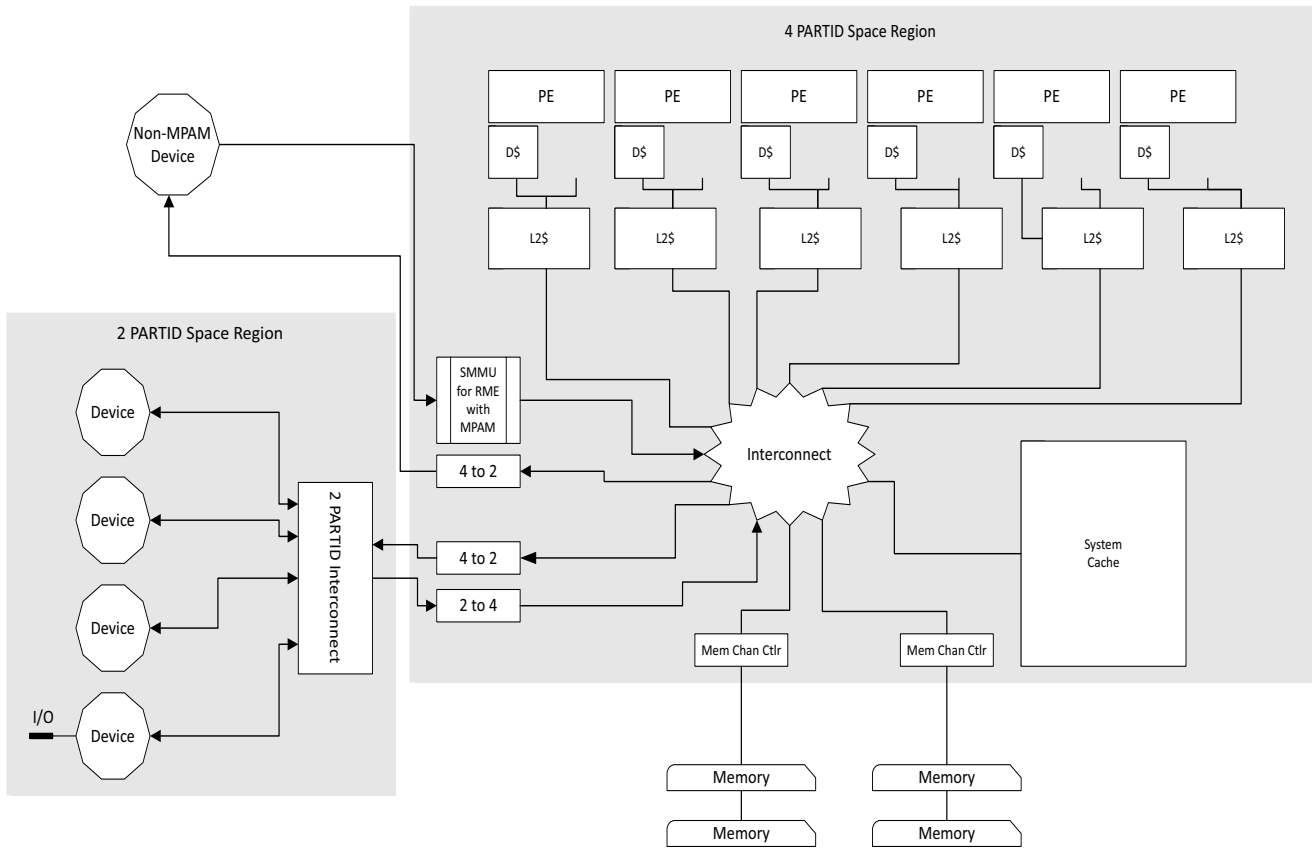

Figure 5-4 Example system with a small four PARTID space region and a large two PARTID space region

Requirements on bridges

The requirements on bridges are:

- The physical address space of a request must not be altered by bridging or other mechanisms.
- Bridging requests that use the Secure PARTID space must not be altered to use a different PARTID space.
- Bridging requests that use the Non-secure PARTID space must not be altered to use a different PARTID space.

5.10.2 Bridging between four-space and two-space regions

This section is *informative*.

Bridges are needed at the boundary between a four-space region and a two-space region. This section presents examples of bridging from two PARTID space Requesters to four PARTID space Completers and in the other direction from four PARTID space Requesters to two PARTID space Completers. Bridging schemes other than the examples given in this section can also be implemented.

Two-Space Requesters

When a two-space MPAM Requester is upstream from a four-space MSC, the Requester's MPAM labels must have the MPAM_NS field expanded to the 2-bit MPAM_SP[1:0] while satisfying the requirements in [Requirements on bridges](#).

When bridging from a two-space region to a four-space region, Arm recommends a static mapping using the fixed MPAM_NS expansion.

Fixed MPAM_NS Expansion at a Requester

The fixed MPAM_NS expansion scheme transforms the MPAM_NS field to 2-bit MPAM_SP[1:0] field according to [Table 5-1](#):

Table 5-1 Two-space Requester to four-space fixed expansion scheme

Two-space MPAM_NS Input	Four-space MPAM_SP[1:0] Output
0b0 (Secure PARTID space)	0b00 (Secure PARTID space)
0b1 (Non-secure PARTID space)	0b01 (Non-secure PARTID space)

The fixed expansion scheme preserves the PARTID space across the mapping.

Two-Space Completers

When a two-space MPAM Completer is downstream from a four-space Requester, the Requester's MPAM labels must have the MPAM_SP field reduced to form the 1-bit MPAM_NS while satisfying the requirements in [Requirements on bridges on page 5-63](#). The reduction function may be static or dynamic.

———— **Note** —————

Arm makes no recommendation for which method to use for bridging between the four-space region of a system that has four PARTID spaces and a two-space region that supports two PARTID spaces. All known methods affect the system operation in ways that could cause difficulties for software.

Control over monitoring of Root and Realm PARTID space requests bridged to Secure or Non-secure PARTID space

A NO_MON flag is used in some of the examples to indicate that the transaction must not be monitored by MPAM monitors or other system performance monitors. This capability improves the security by limiting or preventing the system-level activities of a Realm from being collected in monitors accessible from the Non-secure physical address space or Secure physical address space.

The choice of not monitoring some transactions is not available on true two-space components. Support for the ability to mark requests with the NO_MON flag would likely require modifying the two-space component.

The examples that follow show a small number of recommended choices for including two-space MPAM Completer MSCs that do not have four-space MPAM support in an RME system. [Example 5-1](#) is the most desirable option, but requires extensive work in that it requires a redesign of the MSC. [Example 5-4 on page 5-65](#) requires the least effort but is also the least desirable option:

Example 5-1 Alter the two-space MSC to support 4 PARTID spaces

This is the recommended option. However, it requires work to redesign the MSC. See [Four-space MSC on page 8-179](#) for how this is implemented.

Example 5-2 Alter the two-space MSC to support a programmable mapping of 4 PARTID spaces to 2 PARTID spaces

Alter the two-space MSC to support a programmable mapping of 4 PARTID spaces to 2 PARTID spaces with additional control over whether each of the Root and Realm PARTID spaces can be monitored. See [Programmable PARTID space mapping within a Completer on page 5-65](#).

Example 5-3 Connect the two-space MSC through a programmable PARTID-space mapping component

Connect the two-space MSC through a programmable PARTID-space mapping component, or shim. See [Space mapping external to an MSC](#) on page 5-66.

This gives no control of whether the Root or Realm space can be monitored after being mapped into Secure or Non-secure.

Example 5-4 Connect the two-space MSC to be driven only from MPAM_SP[0]

Connect the two-space MSC so that the single-bit MPAM_NS input of the two-space MSC is driven only from MPAM_SP[0]. See [Fixed space mapping at a Completer](#) on page 5-66.

Programmable PARTID space mapping within a Completer

See [Example 5-2](#) on page 5-64.

A programmable MPAM PARTID space mapping can be performed for a MSC with an PARTID space mapping built into the component. The PARTID space mapper accepts the request with 4 MPAM spaces, maps requests with MPAM_SP of Root or Realm to one of the Secure or Non-secure PARTID spaces and passes it on to the two-space MSC.

The programmable mapper can also produce a flag that indicates the two-space MSC should not perform MPAM monitoring of the request. See [Control over monitoring of Root and Realm PARTID space requests bridged to Secure or Non-secure PARTID space](#) on page 5-64.

The request mapper programming register is MAP4SPTO2SP. It has the fields shown in [Table 5-2](#):

Table 5-2 Request mapper programming register (MAP4SPTO2SP) fields

Field bits	Field name	Description
15	Rt_outPARTID_space	If a request has a Root PARTID, the output PARTID uses this bit for MPAM_NS.
14	Rt_NO_MON	If the request has a Root PARTID, output this bit as the NO_MON flag.
7	RI_outPARTID_space	If a request has a Realm PARTID, the output PARTID uses this bit for MPAM_NS.
6	RI_NO_MON	If the request has a Realm PARTID, output this bit as the NO_MON flag.

The MAP4SPTO2SP register must only be accessible in the Root physical address space.

Space mapping external to an MSC

See [Example 5-3 on page 5-65](#).

A two-space Completer can be connected using a small component external to the MSC that implements a programmable four-space to two-space mapping similar to MAP4SPTO2SP. See [Table 5-3](#):

Table 5-3 Space mapping external to the MSC MAP4SPTO2SP fields

Field bits	Field name	Description
15	Rt_outPARTID_space	If a request has a Root PARTID, the output PARTID uses this bit for MPAM_NS.
14	Rt_NO_MON	If the request has a Root PARTID, output this bit as the NO_MON flag.
7	Rl_outPARTID_space	If a request has a Realm PARTID, the output PARTID uses this bit for MPAM_NS.
6	Rl_NO_MON	If the request has a Realm PARTID, output this bit as the NO_MON flag.

The external mapping register must only be accessible in the Root physical address space.

If the two-space MSC does not have any way to accept the NO_MON flag at the request input, the NO_MON flag is not used. Two-space MSCs are not required to support a NO_MON input.

Fixed space mapping at a Completer

See [Example 5-4 on page 5-65](#).

The fixed MPAM_SP reduction scheme transforms MPAM_SP into a 1-bit MPAM_NS according to [Table 5-4](#):

Table 5-4 Four-space to two-space static reduction scheme

Four-space MPAM_SP Input	Two-space MPAM_NS Output
0b00 (Secure PARTID space)	0b0 (Secure PARTID space)
0b01 (Non-secure PARTID space)	0b1 (Non-secure PARTID space)
0b10 (Root PARTID space)	0b0 (Secure PARTID space)
0b11 (Realm PARTID space)	0b1 (Non-secure PARTID space)

5.10.3 Non-MPAM components

Non-MPAM components do not have the ability to make requests with non-zero MPAM information or to use MPAM information when completing requests. They also do not propagate MPAM information to downstream MSCs.

Non-MPAM Requesters

Arm strongly recommends that a System MMU is used to add MPAM information to requests from non-MPAM Requesters, see *Arm® System Memory Management Unit Architecture Specification, SMMU architecture* (ARM IHI 0070) and *Arm® Realm Management Extension (RME), for SMMUv3 Arm® System Memory Management Unit Architecture Supplement* (ARM IHI 0094).

Requesters attached to an SMMU for RME are only associated with the Secure and Non-secure states, and therefore use two of the four PARTID spaces.

NoStreamID requesters attached to an SMMU for RME might issue transactions to Root or Realm physical address space. For these accesses it is permitted to use Secure and Non-secure PARTID spaces respectively.

Non-MPAM Completers

Completers that have no support for the MPAM information accompanying requests should be interfaced to the system by dropping MPAM information from the requests.

A non-MPAM Completer limits the topology of MPAM in the system because it does not propagate MPAM information to MPAM components downstream. See [Systems with both two PARTID space and four PARTID space components](#) on page 5-61.

Chapter 6

PE Generation of MPAM Information

This chapter contains the following sections:

- *Introduction* on page 6-70.
- *MPAM System registers* on page 6-71.
- *Instruction, data, translation table walk, and other accesses* on page 6-74.
- *Security* on page 6-75.
- *PARTID virtualization* on page 6-78.
- *MPAM AArch32 interoperability* on page 6-84.
- *Support for nested virtualization* on page 6-85.
- *MPAM errors and default ID generation* on page 6-88.
- *MPAM for RME PE generation of MPAM information* on page 6-90.

6.1 Introduction

This introduction is *informative*. Other sections and subsections are *normative* unless marked as *informative*.

In a PE, the generation of PARTID, PMG, and PARTID space MPAM_SP, if RME is implemented, and MPAM_NS if not, labels for memory-system requests are controlled by software running at the current Exception level or higher. The set of MPAM information for:

- An application running at EL0 is controlled from EL1.
- An OS or guest OS running at EL1 is controlled from EL1 or EL2, according to settings controlled at EL2 and EL3.
- A hypervisor or host OS running at EL2 is controlled from EL2 or EL3, according to settings controlled at EL3.
- A guest hypervisor running at EL1 is controlled from EL1 or EL2, according to settings controlled at EL2 and EL3.
- Secure instances of all of the above. If FEAT_RME is implemented, Realm instances of all the above.
- Monitor software running at EL3 is controlled only from EL3.

———— **Note** —————

For information on the presence of MPAM functionality in a PE, see [MPAM versions for PEs on page 1-22](#).

6.2 MPAM System registers

This section is *normative*.

The MPAM PARTIDs are assigned to software by hypervisor and/or kernel software, and a PARTID, PMG, and MPAM_NS are associated with all memory-system requests originated by the PE.

The MPAMn_ELx System registers contain fields for two PARTIDs and the PMG property for each as shown in [Table 6-1](#).

Table 6-1 MPAM System register PARTID and PMG fields

Field name	Description
PARTID_D	PARTID used for data requests.
PARTID_I	PARTID used for instruction requests.
PMG_D	PMG property for PARTID_D.
PMG_I	PMG property for PARTID_I.

The MPAMn_ELx System registers use the register-name syntax shown in [Figure 6-1](#). These registers control MPAM PARTID and PMG, as shown in [Table 6-2 on page 6-72](#) and [Summary of System registers on page 7-98](#) and [System register descriptions on page 7-99](#).

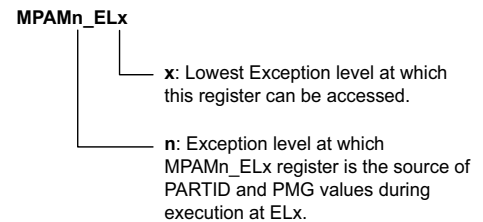

Figure 6-1 MPAM System register name syntax

Table 6-2 shows the PE MPAM System registers. The table does not include the following System registers: MPAMIDR_EL1, MPAMVPMn_EL2, MPAMVPMV_EL2, MPAMHCR_EL2.

Table 6-2 PE MPAM System registers

System register	Controlled from	Supplies PARTID and PMG when Executing in	Notes
MPAM0_EL1	EL3 EL2 EL1	EL0 (Applications)	With the virtualization option and MPAMHCR_EL2.EL0_VPMEN == 1, MPAM0_EL1 PARTIDs can be treated as virtual and mapped to a physical PARTID with virtualization option. Overridden by MPAM1_EL1 when MPAMHCR_EL2.GSTAPP_PLK is set. MPAM0_EL1 may be controlled from only EL3 if MPAM3_EL3.TRAPLOWER == 1, from only EL2 or EL3 if MPAM3_EL3.TRAPLOWER == 0 and MPAMHCR_EL2.TRAPMPAM0EL1 == 1 or from EL1, EL2 or EL3 if MPAM3_EL3.TRAPLOWER == 0 and MPAMHCR_EL2.TRAPMPAM0EL1 == 0.
MPAM1_EL1	EL3 EL2 EL1	EL1 (Guest OS)	Overrides MPAM0_EL1 when MPAMHCR_EL2.GSTAPP_PLK is set. With the virtualization option and MPAMHCR_EL2.EL1_VPMEN == 1, MPAM1_EL1 PARTIDs are treated as virtual and mapped to a physical PARTID. MPAM1_EL1 may be controlled only from EL3 if MPAM3_EL3.TRAPLOWER == 1, only from EL2 or EL3 if MPAM3_EL3.TRAPLOWER == 0 and MPAMHCR_EL2.TRAPMPAM1EL1 == 1, or from EL1, EL2 or EL3 if MPAM3_EL3.TRAPLOWER == 0 and MPAMHCR_EL2.TRAPMPAM1_EL1 == 0. When HCR_EL2.E2H == 1, accesses to MPAM1_EL1 through the MSR and MRS instructions are aliased to access MPAM2_EL2 instead.
MPAM2_EL2	EL3 EL2	EL2 (Hypervisor or host OS)	MPAM2_EL2 is controlled only from EL3 if MPAM3_EL3.TRAPLOWER == 1, or from EL2 or EL3 if MPAM3_EL3.TRAPLOWER == 0.
MPAM3_EL3	EL3	EL3 (Monitor)	MPAM3_EL3 is controlled only from EL3.
MPAM1_EL12	EL2	EL1	Alias to MPAM1_EL1 for type 2 hypervisor host executing with HCR_EL2.E2H == 1.

Table 6-3 on page 6-73 shows the selection of MPAMn_ELx System register for MPAM generation. All of the fields named are in MPAMHCR_EL2:

- GSTAPP_PLK is MPAMHCR_EL2.GSTAPP_PLK.
- EL0_VPMEN is MPAMHCR_EL2.EL0_VPMEN.
- EL1_VPMEN is MPAMHCR_EL2.EL1_VPMEN.

Table 6-3 Selection of MPAMn_ELx System register for MPAM generation

Current Exception level	Use PARTID and PMG fields from:	Perform MPAM virtual PARTID mapping
EL0 with GSTAPP_PLK == 0	MPAM0_EL1	If EL0_VPMEN == 1
EL0 with GSTAPP_PLK == 1	MPAM1_EL1	If EL1_VPMEN == 1
EL1	MPAM1_EL1	If EL1_VPMEN == 1
EL2	MPAM2_EL2	Never
EL3	MPAM3_EL3	Never

6.3 Instruction, data, translation table walk, and other accesses

When a PE generates a memory-system request for an instruction access, the PARTID_I field of an MPAMn_ELx register is used, as shown in [Table 6-3 on page 6-73](#). All translation table walk accesses for instructions use the same PARTID_I field that their instruction accesses use.

When a PE generates a memory-system request for a data access, the PARTID_D field of an MPAMn_ELx register is used, as shown in [Table 6-3 on page 6-73](#). All translation table walk accesses for data access use the same PARTID_D field that their data accesses use.

PARTID_D and PARTID_I fields of an MPAMn_ELx register may be set by software to the same or different PARTIDs. If PARTID_D is used for an access, PMG_D from the same register must also be used. If PARTID_I is used for an access, PMG_I from the same register must also be used.

6.3.1 Load unprivileged and store unprivileged instructions

When executed at EL1 or at EL2 with EL2 Host (E2H), load unprivileged and store unprivileged instructions perform an access using permission-checking for an unprivileged access. These instructions do not change the MPAM labeling of the resulting memory-system requests from the labels that would be generated by other load or store instructions.

6.3.2 Accesses by enhanced support for nested virtualization

In Armv8.4, enhanced support for nested virtualization turns MRS and MSR instructions to certain EL2 registers from EL1 into accesses to a data structure in EL2 memory. As such, these accesses generate PARTID and PMG using MPAM2_EL2.PARTID_D and MPAM2_EL2.PMG_D, respectively.

See [Support for nested virtualization on page 6-85](#).

6.3.3 Accesses by statistical profiling extension

Armv8.2 introduced the Statistical Profiling Extension (SPE). A PE with SPE can be configured to record statistically sampled events into a Profiling Buffer in memory. The buffer is accessed through the owning Exception level's translation regime.

MPAM PARTID, PMG, and MPAM_NS for SPE writes to the Profiling Buffer must use the SPE's owning Exception level MPAM data access values.

For example, if the owning Exception level is EL2, the Profiling Buffer writes must be performed with MPAM2_EL2.PARTID_D, MPAM2_EL2.PMG_D, and MPAM_NS reflecting the Security state of the owning Exception level.

6.3.4 Translation table accesses by AT instructions

Accesses to translation tables by AT instructions are given the MPAM information specified for translation table accesses by a data load instruction that is issued from the Exception level that the AT instruction was executed from. The stage and Exception level specified in the AT instructions do not affect the MPAM information to use.

6.3.5 MPAM information for Granule Protection Table access

In MPAM for RME, accesses to the Granule Protection Table (GPT) use MPAM information according to the current execution Exception Level and Security state and the type of access. See [MPAM information for Granule Protection Table access on page 6-93](#).

6.4 Security

MPAM behavior in the PE and in MSCs is affected by the Security state. While the physical address spaces for memory-system accesses are distinct, the memory-system resources are potentially shared in an implementation. For higher security, running with segregated resources can reduce the effectiveness for side-channel attacks.

The generation of PARTID and PMG for a memory-system request is the same at an ELn in any Security state for the same n. The difference is that requests have the PARTID space derived from the Security state indicated on MPAM_NS by PEs that do not implement RME and on MPAM_SP by PEs that implement RME.

MPAM security behavior in MSCs is covered in [Security in MSCs on page 8-171](#).

6.4.1 Secure and Non-secure PARTID space

In a two-space and four-space PE, generation of Secure PARTIDs are governed by the following Secure MPAM PARTID space rules, described in [PARTID spaces and properties on page 3-39](#):

- PARTIDs in the Secure PARTID space are communicated with MPAM_NS as 0b0 when RME is not implemented or with MPAM_SP as 0b00 if RME is implemented.
- PARTIDs in the Non-secure PARTID space are communicated with MPAM_NS as 0b1 when RME is not implemented or MPAM_SP as 0b01 when RME is implemented.
- When in Secure state:
 - If the MPAM version is v1.0 or greater, MPAM_NS is always 0b0.
 - If the MPAM version is less than v1.0, MPAM_NS might be 0b0 or 0b1. For more information, see [SDEFULT and FORCE_NS settings to control Secure MPAM PARTID use on page 6-76](#).
 - In MPAM for RME, MPAM_SP in the Secure state can be either 0b00 or 0b01. For more information, see [MPAM for RME PE generation of MPAM information on page 6-90](#).
- For RME, the MPAM_NS component of the MPAM information bundle is redefined to be a 2-bit value, MPAM_SP. See [PARTID spaces and properties on page 3-39](#).

In Secure execution, the sourcing of PARTID and PMG in a PE are as described in this specification for Non-secure execution. The PARTID and PMG generation uses MPAMn_ELx to source the labels for the request when executing at Exception level ELn. Non-secure and Secure PARTID generation is the same, including virtual-to-physical PARTID translation, if Secure EL2 is present and enabled, and the MPAM virtualization feature is present and enabled for the MPAM0_EL1 or MPAM1_EL1 register used.

See also [PARTID virtualization on page 6-78](#).

6.4.2 Relationship of PARTID space and physical address space

The PARTID space and the physical address space of a memory transaction initiated by a PE are both based on the Security state, either the current Security state of the PE or in some limited situations, the Security state of the owning Exception level.

The primary PARTID space is always based on the Security state as given in [Primary PARTID space for each Exception level and Security state in RME on page 3-39](#). However, the PARTID space may be changed by MPAM3_EL3.FORCE_NS in MPAM v0.1 or by the alternative PARTID space MPAM feature in MPAM for RME. See [Settings to control Secure MPAM PARTID use in MPAM v0.1 implementations on page 6-76](#) and [Settings to control MPAM PARTID use in MPAM for RME on page 6-77](#).

The physical address space is also based on the PE Security state but may be altered by the MMU in limited situations. For more information, see *Arm® Arm Architecture Reference Manual for A-profile architecture (ARM DDI 0487), Control of Secure or Non-secure memory access*.

6.4.3 SDEFLT and FORCE_NS settings to control Secure MPAM PARTID use

The settings to control the use of Secure MPAM PARTIDs vary depending on the version of MPAM implemented. MPAMv1.0 does not implement `MPAM3_EL3.{SDEFLT, FORCE_NS}` and so the settings are as described in *Secure and Non-secure PARTID space* on page 6-75. The Secure MPAM PARTID use settings for MPAMv1.1 and MPAMv0.1 are detailed in:

- [Settings to control Secure MPAM PARTID use in MPAM v1.1 implementations](#)
- [Settings to control Secure MPAM PARTID use in MPAM v0.1 implementations](#)

Settings to control Secure MPAM PARTID use in MPAM v1.1 implementations

The `MPAM3_EL3.SDEFLT` control enables partial support of Secure PARTIDs as in [Table 6-4](#).

Table 6-4 Behaviors of MPAM3_EL3.SDEFLT in MPAMv1.1 implementations

<code>MPAM3_EL3.SDEFLT</code>	Behavior	
	Non-secure state	Secure state
0b0	Compatible with MPAMv1.0. PARTID is in the Non-secure PARTID space. PARTID and PMG are generated from <code>MPAMn_ELx</code> registers.	Compatible with MPAMv1.0. PARTID is in the Secure PARTID space. PARTID and PMG are generated from <code>MPAMn_ELx</code> registers.
0b1		PARTID is in the Secure PARTID space. PARTID and PMG are generated as the default PARTID and default PMG.

Settings to control Secure MPAM PARTID use in MPAM v0.1 implementations

The `MPAM3_EL3.SDEFLT` and `MPAM3_EL3.FORCE_NS` controls enable partial support of Secure PARTIDs as in [Table 6-5](#).

Table 6-5 Behaviors of MPAM3_EL3.SDEFLT and MPAM3_EL3.FORCE_NS

<code>MPAM3_EL3</code>		Behavior	
<code>SDEFLT</code>	<code>FORCE_NS</code>	Non-secure state	Secure state
0b0	0b0	Compatible with MPAMv1.0. PARTID is in the Non-secure PARTID space. PARTID and PMG are generated from <code>MPAMn_ELx</code> registers.	Compatible with MPAMv1.0. PARTID is in the Secure PARTID space. PARTID and PMG are generated from <code>MPAMn_ELx</code> registers.
	0b1		PARTID is in the Non-secure PARTID space. PARTID and PMG are generated from <code>MPAMn_ELx</code> registers.
0b1	0b0		PARTID is in the Secure PARTID space. PARTID and PMG are generated as the default PARTID and default PMG.
	0b1		PARTID is in the Non-secure PARTID space. PARTID and PMG are generated as the default PARTID and default PMG.

If an implementation has `MPAMIDR_EL1.HAS_FORCE_NS` enabled, the implementation has two options:

- Secure PARTIDs are not implemented. `MPAM3_EL3.FORCE_NS` is RAO/WI.
- `MPAM3_EL3.FORCE_NS` can be written by software. `MPAM3_EL3.FORCE_NS` is RW.

Software can discover which of these options is implemented by testing whether `MPAM3_EL3.FORCE_NS` is writable to zero.

Settings to control MPAM PARTID use in MPAM for RME

When RME is implemented, the PE has four Security states. The controls that affect PARTID space and value involve alternative PARTID space selection with fields in `MPAM3_EL3` and `MPAM2_EL2` affecting the behavior in all ELs and Security states. The `MPAM3_EL3.SDEFLT` control uses only PARTID 0 for all PARTIDs generated in the Secure Security state. The behaviors are also dependent on whether the feature ALTSP is used (see *Alternative PARTID spaces and selection on page 6-90*).

These behaviors are described in [Table 6-6](#). The Alternative space selected column indicates whether the alternative PARTID space is selected instead of the primary PARTID space. If alternative PARTID space MPAM feature is not implemented, the alternative PARTID space is never selected.

Table 6-6 Behaviors of MPAM3_EL3 and MPAM2_EL2 controls on PARTID use in MPAM for RME

<code>MPAM3_EL3.SDEFLT</code>	Alternative space selected	Root state behavior	Secure state behavior	Realm state behavior	Non-secure state behavior
0	No	EL3 PARTID generated from <code>MPAM3_EL3</code> in the Root PARTID space.	EL2-EL0 PARTID generated normally from <code>MPAMn_ELx</code> registers in the Secure PARTID space.	EL2-EL0 PARTID generated normally from <code>MPAMn_ELx</code> registers in the Realm PARTID space.	EL2-EL0 PARTID generated normally from <code>MPAMn_ELx</code> registers in the Non-secure PARTID space.
1	No	EL3 PARTID generated from <code>MPAM3_EL3</code> in the Root PARTID space.	EL2-EL0 PARTID generated as PARTID 0 in the Secure PARTID space.	EL2-EL0 PARTID generated normally from <code>MPAMn_ELx</code> registers in the Realm PARTID space.	EL2-EL0 PARTID generated normally from <code>MPAMn_ELx</code> registers in the Non-secure PARTID space.
0	Yes	EL3 PARTID generated from <code>MPAM3_EL3</code> in the Secure or Non-secure PARTID space.	EL2-EL0 PARTID generated normally from <code>MPAMn_ELx</code> registers in the Non-secure PARTID space.	EL2-EL0 PARTID generated normally from <code>MPAMn_ELx</code> registers in the Non-secure PARTID space.	EL2-EL0 PARTID generated normally from <code>MPAMn_ELx</code> registers in the Non-secure PARTID space.
1	Yes	EL3 PARTID generated from <code>MPAM3_EL3</code> in the Secure or Non-secure PARTID space.	EL2-EL0 PARTID generated as PARTID 0 in the Non-secure PARTID space.	EL2-EL0 PARTID generated normally from <code>MPAMn_ELx</code> registers in the Non-secure PARTID space.	EL2-EL0 PARTID generated normally from <code>MPAMn_ELx</code> registers in the Non-secure PARTID space.

6.5 PARTID virtualization

This introduction to MPAM virtualization support is informative, but subsections are individually marked as *normative* or *informative*.

The PARTID virtualization features described in this section are only available in a Security state in which all of the following conditions are met:

- EL2 is implemented and enabled in the Security state. See also [Unimplemented Exception levels on page 7-160](#).
- MPAM virtualization is supported, as indicated by `MPAMIDR_EL1.HAS_HCR == 1`.

The hardware and software involved in supporting MPAM virtualization includes:

- Accesses made from EL1 to the `MPAMIDR_EL1` register are trapped to EL2 under control of the `MPAMHCR_EL2.TRAP_MPAMIDR_EL1` and `MPAM2_EL2.TIDR` bits. This is done so that the hypervisor can emulate an `MPAMIDR_EL1` access and present an altered view of the register to the guest OS running at EL1. This altered view shows that the `PARTID_MAX` field is a maximum that is equal to the largest virtual PARTID that the hypervisor has set up for the guest OS to use. See [Trap accesses to EL2 and EL1 System registers on page 6-82](#).

———— **Note** —————

`MPAM2_EL2.TIDR` is present when MPAM v0.1 or MPAM v1.1 are implemented and `MPAMIDR_EL1.HAS_TIDR` is 1.

- Guest accesses to MPAM MSC control interfaces page-fault in the stage-2 page tables, thereby trapping to EL2 so that the virtual PARTID used can be access-controlled and mapped to the correct physical PARTID by the hypervisor. The hypervisor can give IPA mappings to an MSC's MPAM feature page that fault at stage 2 to produce this behavior.
- Mapping of guest OS-assigned virtual PARTID values into the physical PARTID space when running guest applications at EL0 and the guest OS at EL1.
- Optionally, an invalid virtual PARTID (that is, one in which the valid bit, `MPAMVPMV_EL2`, is 0) can cause a default virtual PARTID to be used. See [Invalid virtual PARTID behavior on page 6-88](#).
- Support for type-2 hypervisors (for example, kvm) with the `HCR_EL2.E2H` bit set when running the host OS in EL2 with hypervisor functionality. See [Support for type-2 hypervisors on page 6-79](#).

These functions work together to give a guest OS the ability to control its virtual partitions and not trap to the hypervisor when context-switching between applications.

6.5.1 MPAM virtual ID spaces

This section is normative.

MPAM virtual ID spaces only exist if the MPAM virtualization option is implemented, as indicated in `MPAMIDR_EL1.HAS_HCR`.

When `MPAMEN` is 0, a default physical PARTID must be generated for all memory system requests. The value of the default physical PARTID is determined by the Security state. It may be modified by either the `MPAM3_EL3.FORCE_NS` setting if `FORCE_NS` is implemented, or by the alternative PARTID space settings in `MPAM3_EL3` if the alternative PARTID space feature is implemented.

Virtual PARTID spaces can be independently enabled for `MPAM0_EL1` and `MPAM1_EL1` in `MPAMHCR_EL2`. See [Table 6-3 on page 6-73](#). These virtual spaces are mapped into physical PARTID spaces by MPAM virtual PARTID mapping System registers (`MPAMVPM0_EL2` through `MPAMVPM7_EL2`) in PEs. The virtual PARTID mapping registers are set up from EL2 by the hypervisor.

When PARTID is being virtualized, the virtual PARTID is used to index an array of physical IDs contained in the virtual PARTID mapping registers. The index is also used to check the valid flag for that virtual PARTID mapping entry. If the virtual PARTID has a valid mapping, the physical PARTID from the selected virtual PARTID mapping register is used for the memory-system request.

If the virtual PARTID is greater than $(4 * \text{VPMR_MAX}) + 3$, it is outside of the range of virtual PARTID mapping register indices. An out-of-range virtual PARTID is permitted to be replaced by any other in-range virtual PARTID, and this replacement virtual PARTID is used to access the virtual PARTID mapping registers and valid bits. See [Example of virtual-to-physical PARTID mapping on page 6-81](#).

If the virtual PARTID mapping entry accessed is invalid, the default virtual PARTID is used, if it is valid. If neither the accessed virtual PARTID mapping entry nor the default virtual PARTID mapping entry is valid, the default physical PARTID is used for the memory-system request. See [Default PARTID on page 3-40](#).

6.5.2 Support for type-2 hypervisors

The beginning of this section is *normative*.

Arm introduced virtual host extensions in *Armv8.1 Extensions* to better support type-2 hypervisors, such as kvm. These extensions included the EL2 Host (E2H) bit in the hypervisor control register.

With type-2 hypervisors, the host runs at EL2 and runs host applications at EL0. The host runs guest OSs at EL1 with their applications at EL0. Type-2 hypervisors run with $\text{HCR_EL2.E2H} == 1$. In this case, some MPAM System register addresses access different MPAM System registers. This allows the host OS to run at EL2 while using the same System register addresses it would use when running at EL1.

Table 6-7 MPAM1_EL1 register accessed at EL2

System register accessing instruction	Named register	Associated register accessed at EL2
op1=0, CRn=10, CRm=5, op2=0	MPAM1_EL1	MPAM2_EL2

At EL2, accesses to an associated EL2 register using the normal (op1=4) encoding need explicit synchronization to be ordered with respect to accesses to the same register using this new mechanism.

In this configuration, the following aliases for the same set of EL1 registers are introduced for access at EL2 or EL3 (these registers are UNDEFINED at EL1 and EL0). A different register name is used to access the registers. When at EL3, accesses to the EL1 register using the normal (op1=0) value need explicit synchronization to be ordered with respect to accesses to the same register using this new mechanism.

Table 6-8 MPAM1_EL12 register accessed at EL2

System register accessing instruction	Named register	Associated register accessed at EL2
op1=5, CRn=10, CRm=5, op2=0	MPAM1_EL12	MPAM1_EL1

The remainder of this section is *informative*. It describes how a type-2 hypervisor (host OS) might use the MPAM hardware:

- MPAM1_EL12 is accessed by the host OS running at EL2 and is an alias for MPAM1_EL1. This register controls the MPAM PARTIDs and PMGs used when running a guest at EL1.
- MPAM1_EL1 is accessed by the host OS running at EL2 and is an alias for MPAM2_EL2. This register controls the host's access to its own MPAM controls.
- MPAM0_EL1 is accessed by the host OS running at EL2. This permits the host OS to control the MPAM PARTIDs and PMGs used by its applications. E2H does not alter this access. When running host applications at EL0, the host also sets $\text{HCR_EL2_TGE} == 1$ to route exceptions in the EL0 application to the host in EL2 rather than EL1.

- MPAMHCR_EL2 access is used by the host at EL2 to control the enables for virtual PARTID mapping and the trapping of MPAMIDR_EL1. E2H does not alter this access.
- MPAMVPMV_EL2 is used by the host at EL2 to control the validity of virtual PARTID mapping entries used to virtualize the guest's PARTIDs. E2H does not alter this access.
- MPAMVPMn_EL2 registers are used by the host at EL2 to contain the virtual PARTID mapping entries. These are set by the hypervisor at EL2 and used when running the guest OS and its applications. E2H does not alter this access.

The use of MPAM System registers by a guest OS is not altered by E2H:

- MPAM0_EL1 is accessed from EL1. This permits a guest OS to control the MPAM PARTIDs and PMGs used by its applications. E2H does not alter this access.
- MPAM1_EL1 is accessed by the guest OS running at EL1 to change MPAM context for the guest OS running at EL1, unless trapped to EL2 by MPAM2_EL2.TRAPMPAM1EL1 == 1, or trapped to EL3 by MPAM3_EL3.TRAPLOWER == 1. E2H does not alter this access.

6.5.3 Mapping of guest OS virtual PARTIDs

This section is *informative*. It describes how software might use MPAM hardware.

When virtualizing MPAM, the hypervisor controls the use of PARTIDs by guest OSs. The hypervisor can:

- Set the number of virtual PARTIDs that a guest OS is permitted to assign and use. This number is communicated by trapping access by the guest to MPAMIDR_EL1.
- Permit the guest OS to use virtual PARTIDs for applications running at EL0 and to change them by writing to MPAM0_EL1.
- Permit the guest OS to also use virtual PARTIDs when running at EL1 and to change them by writing to MPAM1_EL1.
- Map each of the guest's virtual PARTIDs from the range of 0 to the maximum guest PARTID into a physical PARTID for the current Security state. It does this by means of the MPAMVPMn virtual PARTID mapping registers that are managed by the hypervisor.

PMGs modify PARTID and do not need any further virtualization support.

Virtualized guests are limited to using PARTIDs in the range of 0 to n, where n is the implemented virtual PARTID mapping entries. The parameters are:

- MPAMIDR_EL1.VPMR_MAX has the number of virtual PARTID mapping registers implemented. Each virtual PARTID mapping register contains four mapping entries.
- The largest virtual PARTID is $n = (4 * VPMR_MAX) + 3$.

If VPMR_MAX == 0, there is only one virtual PARTID mapping register, 4 virtual PARTID mapping entries, and the maximum corresponding virtual PARTID is 3.

The following registers and fields are used to control virtualization:

MPAMHCR_EL2 control fields:

- EL0_VPMEN: Enable virtual PARTID mapping from MPAM0_EL1 when executing an application at EL0. If HCR_EL2.E2H == 1 and HCR_EL2.TGE == 1, MPAM is not virtualized EL0. If GSTAPP_PLK == 1, MPAM1_EL1 is used instead of MPAM0_EL1 when executing at EL0 and virtualization of PARTIDs is controlled by EL1_VPMEN.
- EL1_VPMEN: Enable virtual PARTID mapping from MPAM1_EL1 when executing a guest OS at EL1. If GSTAPP_PLK == 1 when executing at EL0, MPAM1_EL1 is used instead of MPAM0_EL1 and MPAM virtualization is controlled by EL1_VPMEN instead of EL0_VPMEN.

MPAMVPM0_EL2 to MPAMVPM7_EL2 registers:

- Each register has four 16-bit fields. Each field contains a physical PARTID.
- Together they form a virtual PARTID mapping vector that maps the virtual PARTIDs into the physical PARTID space.
- Within each physical PARTID field, only sufficient low-order bits are required to represent the MPAMIDR_EL1.PARTID_MAX. Higher-order bits may be implemented as RAZ/WI.

MPAMVPMV_EL2 register:

- MPAMVPMV_EL2 contains $4*(m+1)$ valid bits, indexed from 0 to $(4*m + 3)$, one bit for each of the implemented virtual PARTIDs supported in the MPAMVPMn_EL2 registers, where $m = MPAMIDR_EL1.VPMR_MAX$ and n ranges from 0 to n .
- There can be up to 32 virtual-to-physical PARTID mappings. If a virtual PARTID is greater than the maximum index supported, an in-range virtual PARTID is permitted to be accessed instead ([MPAM AArch32 interoperability on page 6-84](#)).

Example of virtual-to-physical PARTID mapping

This section is *informative*.

- If the current execution level is EL1:
 - If $EL1_VPMEN == 0$, then virtualization is disabled at EL1, and $MPAM1_EL1.PARTID_D$ and $MPAM1_EL1.PARTID_I$ are physical PARTIDs.
 - If $EL1_VPMEN == 1$, then virtualization is enabled at EL1 and $MPAM1_EL1.PARTID_D$ and $MPAM1_EL1.PARTID_I$ are virtual PARTIDs that are to be mapped to physical PARTIDs.
- Assume $MPAMIDR_EL1.VPMR_MAX == 0b010$. That means the largest virtual PARTID is $4*2+3 = 11$. Therefore, 12 virtual PARTIDs, from 0 to 11, can be mapped to physical PARTIDs.
- Assume $MPAM1_EL1.PARTID_D$ contains 6:
 - $MPAMVPMV_EL2.VPM_V<6>$ is checked to determine if the mapping for virtual PARTID 6 is valid. $MPAMVPMV_EL2.VPM_V<6> == 1$ means virtual PARTID 6 is valid. $MPAMVPMV_EL2.VPM_V<6> == 0$ means virtual PARTID 6 is invalid.
 - If a valid mapping exists ($VPM_V<6> == 1$), the physical PARTID is in $MPAMVPM1_EL2.Phys_PARTID6$.
 - If a valid mapping does not exist ($VPM_V<6> == 0$), the mapping for the default virtual PARTID is used.
 - If a valid mapping does not exist for the default virtual PARTID, the default physical PARTID is used.
- For out-of-range virtual PARTIDs, an implementation can choose any other virtual PARTID to use instead. This permits truncation of inputs that have too many bits. It also permits other reductions to in-range PARTIDs. For example, if $VPMR_MAX$ is 2, the virtual PARTID 13 is out of range. In this example, an implementation might save time by forcing the 8s bit (bit number 4) to 0 when both the 8s bit and 4s bit (bit number 3) are 1 in the virtual PARTID. This technique selects virtual PARTID mapping entry 5 instead of out-of-range 13. The technique is sometimes called “replacement virtual PARTID”. One must still do the steps of bullet 3, above, on the replacement virtual PARTID.

6.5.4 Guest OS and all its applications under single PARTID

This section is *normative*.

GSTAPP_PLK is a control bit in MPAMHCR_EL2. The bit causes MPAM1_EL1 to be used instead of MPAM0_EL1 when executing at EL0. This GSTAPP_PLK function runs all EL0 applications of a VM in the same partition as the EL1 guest OS.

When GSTAPP_PLK is active, MPAM0_EL1 is not used for PARTID or PMG generation. If virtual PARTID mapping is enabled for EL1, the EL1 PARTID_I or PARTID_D is mapped to a physical PARTID before being used for requests originating from applications at EL0, as well as for the guest OS at EL1.

———— **Note** ————

The guest OS at EL1 cannot determine whether GSTAPP_PLK is active or not. EL1 access to read and write MPAM0_EL1 is not affected by GSTAPP_PLK == 1.

6.5.5 Trap accesses to EL2 and EL1 System registers

The available traps include those that:

- Virtualize [MPAMIDR_EL1](#).
- Control access by EL1 to [MPAM1_EL1](#) and [MPAM0_EL1](#).
- Control access to MPAM registers from EL2 and EL1.

Virtualizing MPAMIDR_EL1

EL2 software can force accesses to [MPAMIDR_EL1](#) to trap to EL2 by setting [MPAMHCR_EL2.TRAP_MPAMIDR_EL1](#) == 1 or [MPAM2_EL2.TIDR](#) == 1. By trapping [MPAMIDR_EL1](#), an EL2 hypervisor can provide an emulated value for [MPAMIDR_EL1](#) to the EL1 software.

———— **Note** ————

[MPAM2_EL2.TIDR](#) is present when [MPAMIDR_EL1.HAS_TIDR](#) is 1. Arm recommends that when MPAM v0.1 or MPAM v1.1 are implemented, [MPAMIDR_EL1.HAS_TIDR](#) is set to 1 and [MPAM2_EL2.TIDR](#) is implemented.

Trapping accesses to MPAM2_EL2

Accesses to [MPAM2_EL2](#) from EL2 are trapped to EL3 when [MPAM3_EL3.TRAPLOWER](#) == 1.

Controlling accesses to MPAM1_EL1

EL2 software can control whether EL1 software can access [MPAM1_EL1](#). Accesses to [MPAM1_EL1](#) from EL1 are trapped to EL2 when [MPAM2_EL2.TRAPMPAM1EL1](#) == 1.

[MPAM1_EL12](#) is an alias for [MPAM1_EL1](#) accessed from EL2. It is therefore not subject to traps from [MPAM2_EL2.TRAPMPAM1EL1](#).

When [HCR_EL2.E2H](#) == 1, [MPAM1_EL1](#) is an alias for [MPAM2_EL2](#) accessed from EL2. It is therefore not subject to traps from [MPAM2_EL2.TRAPMPAM1EL1](#).

Controlling accesses to MPAM0_EL1

EL2 software can control whether EL1 software can access [MPAM0_EL1](#). Accesses to [MPAM0_EL1](#) from EL1 are trapped to EL2 when [MPAM2_EL2.TRAPMPAM0EL1](#) == 1.

Trapping all MPAM registers

When EL2 or EL1 software does not context switch MPAM state, such as when the software does not support MPAM at all, the MPAM System registers might be used to pass information between virtual machines or applications.

EL3 software can trap accesses to MPAM registers from all lower Exception levels to EL3 by setting [MPAM3_EL3.TRAPLOWER](#) == 1.

[TRAPLOWER](#) protects against misuse of the MPAM state registers when EL2 software does not support MPAM context switching.

If EL2 software is present and supports MPAM but EL1 software does not, MPAM2_EL2.TRAPMPAM1EL1 and TRAPMPAM0EL1 protect against misuse by an unaware guest while permitting EL2 to set up an MPAM environment for that guest.

If there is no EL2 or no EL2 software, TRAPLOWER can prevent misuse of MPAM registers by EL1 software.

MPAM3_EL3.TRAPLOWER traps have priority over all traps controlled by MPAM2_EL2 and MPAMHCR_EL2.

6.6 MPAM AArch32 interoperability

This section is *normative*.

MPAM System registers are not accessible from AArch32, so the MPAM PARTIDs and PMGs for any Exception level that uses AArch32 state must be set up by a higher Exception level that uses AArch64 state.

6.7 Support for nested virtualization

This section is *normative*.

Armv8.3 Extensions added FEAT_NV for nested virtualization, and *Armv8.4 Extensions* added FEAT_NV2 to the nested virtualization support. This section describes the support of MPAM with these extensions.

6.7.1 Nested virtualization extension

Armv8.3 Extensions added support for nested virtualization. This subsection only applies if *Armv8.3* nested virtualization extension is implemented.

[Table 6-9](#) lists the System registers that are trapped from EL1 to EL2 rather than being UNDEFINED when HCR_EL2.NV == 1, and HCR_EL2.NV2 == 0, and MPAM3_EL3.TRAPLOWER == 0.

Table 6-9 Registers trapped from EL1 to EL2 when HCR_EL2.NV == 1

MPAM1_EL12	MPAMVPMV_EL2	MPAMVPM2_EL2	MPAMVPM5_EL2
MPAM2_EL2	MPAMVPM0_EL2	MPAMVPM3_EL2	MPAMVPM6_EL2
MPAMHCR_EL2	MPAMVPM1_EL2	MPAMVPM4_EL2	MPAMVPM7_EL2

When HCR_EL2.NV == 1, and HCR_EL2.NV2 == 0, and MPAM3_EL3.TRAPLOWER == 1, access to any of the listed MPAM System registers from EL1 traps to EL3.

There are no other changes to the v8.3 nested virtualization extension to support the MPAM Extension.

6.7.2 Enhanced nested virtualization extension

Armv8.4 Extensions introduced FEAT_NV2, an enhancement for nested virtualization. This enhancement transforms direct reads or writes (the terms “direct reads” and “direct writes” are defined in the Arm ARM) of several registers (that is, the target System register names in an MRS or MSR instruction) from EL1 to loads or stores, respectively, in the same Security state.

The remainder of this section applies only if both the FEAT_NV and FEAT_NV2 extensions are implemented.

If HCR_EL2.NV2 == 0, MSR or MRS instructions do not cause reads or writes to occur to the memory, and the behavior of the HCR_EL2.NV and HCR_EL2.NV1 bits is as described in the *Armv8.3* architecture.

If HCR_EL2.NV2 == 1:

- If HCR_EL2.NV == 1 and HCR_EL2.NV1 == 0 for a Security state, direct reads or writes of any of the following MPAM register names (that is, the target System register names in the MRS or MSR instruction) from EL1 in the same Security state to be treated as loads or stores respectively. The memory address access is VNCR_EL2.BADDR<<12 + Offset from [Table 6-10](#) as described in *Armv8.4 Extensions*.

Table 6-10 Enhanced nested virtualization offsets of System registers (NV2 == 1, NV1 == 0, and NV == 1)

Register Name	Offset
MPAM1_EL12	0x900
MPAMHCR_EL2	0x930
MPAMVPMV_EL2	0x938
MPAMVPM0_EL2	0x940
MPAMVPM1_EL2	0x948
MPAMVPM2_EL2	0x950
MPAMVPM3_EL2	0x958
MPAMVPM4_EL2	0x960
MPAMVPM5_EL2	0x968
MPAMVPM6_EL2	0x970
MPAMVPM7_EL2	0x978

- If HCR_EL2.NV == 1 and HCR_EL2.NV1 == 1 for a Security state, direct reads or writes of any of the registers in [Table 6-11](#) (that is, the target System register names in an MRS or MSR instruction) from EL1 in the same Security state are treated as loads or stores, respectively, in the same Security state. The memory address access is VNCR_EL2.BADDR<<12 + Offset from [Table 6-9 on page 6-85](#) as described in *Armv8.4 Extensions*.

Table 6-11 Enhanced nested virtualization offsets of System registers (NV2 == 1, NV1 == 1 and NV == 1)

Register Name	Offset
MPAM1_EL1	0x900
MPAMHCR_EL2	0x930
MPAMVPMV_EL2	0x938
MPAMVPM0_EL2	0x940
MPAMVPM1_EL2	0x948
MPAMVPM2_EL2	0x950
MPAMVPM3_EL2	0x958
MPAMVPM4_EL2	0x960

Table 6-11 Enhanced nested virtualization offsets of System registers (NV2 == 1, NV1 == 1 and NV == 1) (continued)

Register Name	Offset
MPAMVPM5_EL2	0x968
MPAMVPM6_EL2	0x970
MPAMVPM7_EL2	0x978

When HCR_EL2.NV == 1 and HCR_EL2.NV2 == 1, MPAM3_EL3.TRAPLOWER is overridden for those registers listed in [Table 6-10 on page 6-86](#) if HCR_EL2.NV1 == 0 or in [Table 6-11 on page 6-86](#) if HCR_EL2.NV1 == 1. When HCR_EL2.NV == 1 and HCR_EL2.NV2 == 1, MPAM3_EL3.TRAPLOWER == 1 does not cause an access from EL1 to an MPAM System register in the tables to be trapped to EL3, but that access is converted to a memory read or write as described in this subsection.

6.7.3 MPAM PARTID and PMG for enhanced nested virtualization loads and stores

For Armv8.4 enhanced nested virtualization support, when HCR_EL2.NV2 == 1 and HCR_EL2.NV == 1, MRS or MSR instructions to any System register that are converted to loads or stores must be performed with the MPAM PARTID_D and PMG_D from MPAM2_EL2.

6.8 MPAM errors and default ID generation

MPAM errors are detected when a memory request is generated by a load, store, fetch, or table-walk with the following conditions:

- Physical or virtual PARTID or PMG is out of range.
- Virtual PARTID n is invalid, as indicated by `MPAMVPMV_EL2<n>`.

In a given implementation, some errors may never occur. For example, an implementation with only w bits of PARTID and `MPAMIDR.PARTID_MAX` as $(2^w - 1)$, and that truncates PARTID values with non-zero bits higher than $w - 1$, can never have a physical PARTID out-of-range error. See [Default PARTID on page 3-40](#).

6.8.1 Out-of-range PARTID behavior

The behavior of a PE when a physical or virtual PARTID from `PARTID_I` or `PARTID_D` of an `MPAMn_ELx` register is out of range is CONstrained UNPREDICTABLE as one of:

- The out-of-range PARTID is replaced by the default PARTID in the same PARTID space.
- The out-of-range PARTID is replaced by any in-range PARTID in the same PARTID space.

6.8.2 Out-of-range PMG behavior

The behavior of a PE when an `MPAMn_ELx` register's `PMG_I` or `PMG_D` is out-of-range CONstrained UNPREDICTABLE is one of:

- The out-of-range PMG is replaced by the default PMG.
- The out-of-range PMG is replaced by any in-range PMG.

6.8.3 Invalid virtual PARTID behavior

The behavior of a PE, when (i) a `PARTID_I` or `PARTID_D` from an `MPAMn_ELx` register (or a replacement PARTID as in [Out-of-range PARTID behavior](#)) is used as a virtual PARTID n , and (ii) the corresponding bit `MPAM_VMPV_EL2<n> == 0`, the default virtual PARTID must be used if it is valid (`MPAM_VPMV_EL2<0> == 1`). If neither the accessed virtual PARTID mapping entry nor the default virtual PARTID mapping entry is valid, the default physical PARTID must be used for the memory-system request. See [Default PARTID on page 3-40](#).

6.8.4 PARTID space on error

When an error is encountered in the generation of PARTID, the replacement PARTID is generated in the PARTID space as shown in [Table 6-12](#).

Table 6-12 PARTID space for PARTID generation errors

Error	Space of replacement PARTID
NS virtual PARTID out of range	NS virtual PARTID
NS virtual PARTID mapping entry invalid	NS virtual PARTID
NS default virtual PARTID is invalid	NS physical PARTID
S virtual PARTID out of range	S virtual PARTID
S virtual PARTID mapping entry invalid	S virtual PARTID
NS physical PARTID out of range	NS physical PARTID
S physical PARTID out of range	S virtual PARTID

6.8.5 MPAM3_EL3.SDEFULT and MPAM generation errors

When executing in Secure state, [MPAM3_EL3.SDEFULT](#) sets the MPAM generation to produce only zero for PARTIDs. The default PARTID is always valid, so PARTID Out-of-range errors cannot occur in Secure state when [MPAM3_EL3.SDEFULT](#) is 1. The PARTID space for the default PARTID is determined by the [Table 6-5](#) when RME is not implemented and [Table 6-6](#) when RME is implemented.

———— **Note** —————

[MPAM3_EL3.MPAMEN](#) and [MPAM3_EL3.SDEFULT](#) have a similar function. However, when [MPAM3_EL3.MPAMEN](#) is 0 in any Security state:

- MPAM generation produces only zero for the physical PARTID in all memory-system requests.
- Virtual PARTID mapping is not performed.
- PARTIDs cannot generate Out-of-range errors.

When [MPAM3_EL3.SDEFULT](#) is 1, PMG is always 0, and always valid. PMG generation is not virtualized.

6.8.6 MPAM3_EL3.FORCE_NS and MPAM generation errors

[MPAM3_EL3.FORCE_NS](#) is only present in MPAM v0.1. When in Secure state, [MPAM3_EL3.FORCE_NS](#) changes the MPAM generation in the PE so that [MPAM_NS](#) is set to 1 rather than 0. This means that only Non-secure MPAM information will accompany memory system requests from a PE, so MSCs will receive Non-secure PARTIDs from those requests.

[FORCE_NS](#) does not change the way that the value of the PARTID is produced, only whether the generated PARTID is a Secure PARTID or a Non-secure PARTID. This means that generation of the physical PARTID and PMG for the MPAM information to label memory system requests are unchanged by [FORCE_NS](#). The generation of MPAM information in the PE can produce any of the MPAM generation error behaviors described in [MPAM errors and default ID generation on page 6-88](#).

6.9 MPAM for RME PE generation of MPAM information

A PE that implements FEAT_RME has the capability to execute in the Realm and Root Security states and to generate accesses to the Realm and Root physical address spaces.

6.9.1 PE and MPAM

A PE that implements FEAT_RME must generate the PARTID space according to the Security state from which the memory system request is made.

Each Security state has a primary PARTID space named for that Security state as shown in [Table 6-13](#).

The alternative PARTID space MPAM feature, ALTSP, allows an alternative PARTID space to be used in each Security space rather than the primary PARTID space. See [Alternative PARTID spaces and selection](#).

Table 6-13 MPAM_SP encoding for each PARTID space

PARTID Space	MPAM_SP[1:0]
Non-secure PARTID space	0b01
Secure PARTID space	0b00
Realm PARTID space	0b11
Root PARTID space	0b10

Support by the PE for the four PARTID spaces is identified in [MPAMIDR_EL1](#). In a PE that implements RME and MPAM, [MPAMIDR_EL1.SP4](#) must be 1.

6.9.2 Alternative PARTID spaces and selection

The alternative PARTID Space feature, ALTSP, defines alternative PARTID spaces for each of the Security states.

[MPAM3_EL3](#) and [MPAM2_EL2](#) have fields to control whether the primary or alternative PARTID space is used at those Exception levels and lower Exception levels.

The ALTSP feature permits the selection of either the primary PARTID space or the alternative PARTID space for PARTIDs in the [MPAMn_ELx](#) registers. The primary and alternative PARTID spaces for each Security state are shown in [Table 6-14](#). The primary PARTID space is shown, where the PARTID space name is the same as the Security state.

Table 6-14 Primary and alternative PARTID spaces

Security state	Primary PARTID space	Alternative PARTID Space
Non-secure	Non-secure PARTID space	Same
Secure	Secure PARTID space	Non-secure PARTID space
Realm	Realm PARTID space	Non-secure PARTID space
Root	Root PARTID space	Secure or Non-secure PARTID space

The choice of the alternative space for Root is made in [MPAM3_EL3](#) in the [RT_ALTSP_NS](#) field:

- 0b1 selects the Non-secure PARTID space as the alternative PARTID space for the Root Security state.
- 0b0 selects the Secure PARTID space as the alternative PARTID space for the Root Security state.

The ALTSP feature controls do not affect the PARTID space when used in the Non-secure state. The Non-secure PARTID space is always used in the Non-secure Security state.

See [MPAM3_EL3](#) and [MPAM2_EL2](#) for details of these controls. The ALTSP feature is identified in [MPAMIDR_EL1.HAS_ALTSP](#).

Selection of primary or alternative PARTID space when executing at EL3

When executing at EL3, the PE is in the Root Security state.

The selection of primary or alternative PARTID space for memory system requests generated in the Root Security state is controlled by these bits in [MPAM3_EL3](#):

- [RT_ALTSP_NS](#) sets whether the alternative PARTID space in the Root Security state is the Non-secure PARTID space or the Secure PARTID space.
- [ALTSP_EL3](#) sets whether memory system requests generated from EL3 use the alternative PARTID space or the primary PARTID space. The selected PARTID space is used for all accesses that use [MPAM3_EL3.PARTID_I](#) or [MPAM3_EL3.PARTID_D](#).

These two bits combine to give three combinations for PARTID space used for accesses from EL3 in the Root state.

Table 6-15 EL3 PARTID space selection

MPAM3_EL3.RT_ALTSP_NS	MPAM3_EL3.ALTSP_EL3	PARTID space
x	0	Root PARTID space
0	1	Secure PARTID space
1	1	Non-secure PARTID space

Selection of primary or alternative PARTID space when executing at EL2, EL1 and EL0

When executing at EL2, EL1 or EL0, the Security state can be one of Secure, Non-secure, or Realm. The current Security state for all Exception levels below EL3 is set in [SCR_EL3](#) by the NS and NSE bits.

The Root firmware running in EL3 can either permit EL2 to control its own PARTID space and the PARTID space used by EL1 and EL0, or it can force the primary or alternative space to be selected for EL2, EL1, and EL0.

If EL3 is not forcing a selection on EL2, EL2 can select whether PARTIDs generated at EL2 use the primary or alternative PARTID space using [MPAM2_EL2.ALTSP_EL2](#). When EL3 is not forcing a selection on EL2, EL2 can also select whether the primary or alternative PARTID space is used by EL1 and EL0.

EL3 forces a selection on all lower ELs by clearing [MPAM3_EL3.ALTSP_HEN](#) and setting [MPAM3_EL3.ALTSP_HFC](#) to force the alternative PARTID space or clearing [ALTSP_HFC](#) to force the primary PARTID space on all lower ELs.

When EL2 is implemented but is disabled for the Security state, the alternative PARTID space is selected for EL1 and EL0 when [MPAM3_EL3.ALTSP_HEN](#) is 0 and [MPAM3_EL3.ALTSP_HFC](#) is 1. Otherwise the primary PARTID space is selected.

The set of combinations for EL2 PARTID space selection are shown in [Table 6-16](#).

Table 6-16 EL2 PARTID space selection

MPAM3_EL3.ALTSP_HEN	MPAM3_EL3.ALTSP_HFC	MPAM2_EL2.ALTSP_EL2	EL2 PARTID space
0	0	x	Primary
0	1	x	Alternative
1	x	0	Primary
1	x	1	Alternative

The set of combinations for EL1 and EL0 PARTID space selection are shown in Table 6-17. When EL2 is not implemented or when EL2 is implemented but not enabled for the Security state, read Table 6-17 as if MPAM2_EL2.ALTSP_HFC is 0.

Table 6-17 EL1 and EL0 PARTID space selection

MPAM3_EL3.ALTSP_HEN	MPAM3_EL3.ALTSP_HFC	MPAM2_EL2.ALTSP_HFC	EL1 and EL0 PARTID space
0	0	x	Primary
0	1	x	Alternative
1	x	0	Primary
1	x	1	Alternative

Determining forced PARTID space in EL2, EL1 and EL0

In each of MPAM2_EL2 and MPAM1_EL1, the ALTSP_FRCD bit indicates that the alternative PARTID space has been forced on PARTIDs in MPAM2_EL2 and on PARTIDs in MPAM1_EL1 and MPAM0_EL1, respectively. Since EL1 and EL0 selection is always identical and EL1 controls PARTIDs in MPAM0_EL1, there is no need for a separate indication in MPAM0_EL1.

There is no means provided for software running in EL0 to determine whether it is using the primary or alternative PARTID space. The PARTID space selection at EL0 is the same as for the Exception level of the operating system that controls the EL0 application. That OS is at EL2 if the virtualization host extension, host mode, is being used as indicated when MPAMHCR_EL2.E2H and MPAMHCR_EL2.TGE are both set to 1. Otherwise, the controlling operating system is at EL1.

Alternative PARTID space and PARTID virtualization

Because the choice of primary or alternative PARTID spaces at EL1 and EL0 can be controlled from EL2 and because MPAM1_EL1.PARTID_I and MPAM1_EL1.PARTID_D are in the same PARTID space, EL2 can set up PARTID virtualization into the correct PARTID space for EL1.

Similarly, MPAM1_EL1.PARTID_I and MPAM0_EL1.PARTID_D are in the same PARTID space as the MPAM1_EL1 PARTIDs so that the PARTID virtualization setup for EL1 can also be used for EL0.

PARTID virtualization is enabled for MPAM1_EL1 PARTIDs by setting MPAMHCR_EL2.EL1_VPMEN and for MPAM0_EL1 PARTIDs by setting MPAMHCR_EL2.EL0_VPMEN. Setting up PARTID virtualization also requires EL2 software to program physical PARTIDs from the selected PARTID space into the MPAMVPM<n>_EL2 registers, and enable those translations in the MPAMVPMV_EL2 register.

ALTSP and FORCE_NS

ALTSP can have the same effect of forcing PARTIDs in the Secure state to be in the Non-secure PARTID space as MPAM3_EL3.FORCE_NS. ALTSP also provides controls for the Root and Realm Security state selection of PARTID space.

———— **Note** ————

ALTSP and FORCE_NS are conflicting MPAM features. The ALTSP feature is required and the FORCE_NS feature is prohibited in PEs that implement MPAM for RME.

ALTSP in Host mode at EL0

When a host OS running at EL2 executes an application, it expects the same behavior as if it was an EL1 OS running an application. The behaviors to support running a host OS at EL2 are controlled by HCR_EL2.E2H. The control bit HCR_EL2.TGE supports running an application of the host OS at EL0.

When running at EL0 in host mode, the EL2 selection of primary versus alternative PARTID space is used to govern the selection in EL0.

When HCR_EL2.E2H and HCR_EL2.TGE are both 1, the alternative PARTID space in EL0 is selected only if the alternative space would be selected in EL2. When either of E2H or TGE is 0, the alternative PARTID space in EL0 is selected only if the alternative space would be selected in EL1.

6.9.3 MPAM information for Granule Protection Table access

In MPAM for RME, accesses to the Granule Protection Table (GPT) as a result of a data access, instruction access or translation table walk use the same MPAM information as the original access.

- A GPT access as the result of a data access uses PARTID_D and PMG_D for the current Exception level.
- A GPT access as the result of an instruction access uses PARTID_I and PMG_I for the current Exception level.
- A GPT access as the result of a translation table walk uses the PARTID_D and PMG_D for the current Exception level.
- A GPT access uses the PARTID space selected from the current Security state and current Exception level according to [Alternative PARTID spaces and selection on page 6-90](#).

Chapter 7

System Registers

This chapter contains the following sections:

- *Overview on page 7-96.*
- *Synchronization of System register changes on page 7-97.*
- *Summary of System registers on page 7-98.*
- *System register descriptions on page 7-99.*
- *MPAM enable on page 7-155.*
- *SDEFLT on page 7-156.*
- *Lower-EL MPAM register access trapping on page 7-157.*
- *FORCE_NS on page 7-158.*
- *Reset on page 7-159.*
- *Unimplemented Exception levels on page 7-160.*

7.1 Overview

System registers are implemented in PEs and accessed using the MRS and MSR instructions.

7.2 Synchronization of System register changes

Direct writes to System registers are only guaranteed to be visible to indirect reads after a Context synchronization event, as described in the *Arm® Architecture Reference Manual for A-profile architecture*.

Writes to MPAM System registers must be visible for generation of MPAM information in new memory requests after a Context synchronization event.

When MPAM System registers are set at one Exception level and used for generation of MPAM information at another Exception level, the change of Exception level is a Context synchronization event that makes the previous direct writes to MPAM registers visible for generating MPAM information.

If an MPAM register is updated at the same Exception level at which it is used for generation of MPAM information on memory-system requests, software must ensure that a Context synchronization event, such as an Instruction Synchronization Barrier, is executed after the direct write to the MPAM System register and before the changed System register value is certain to be used for labeling memory system requests.

The *Arm® Architecture Reference Manual for A-profile architecture* requires that a direct write to a System register must not affect instructions before the direct System register write in program order.

If System registers are used for configuration of memory-system controls that are implemented in the PE, a Data Synchronization Barrier must ensure that the prior memory accesses are completed before the update. No such System registers are defined here. Additional requirements will be described if and when such requirements are added.

When MPAM System registers are updated, TLB maintenance is not required. Only a Context synchronization event is required before the updated value is guaranteed to be used for memory requests. This means that MPAM information is not permitted to be cached in a TLB and used instead of using System registers for the generation of MPAM information.

7.3 Summary of System registers

In a PE, the MPAM System registers shown in [Table 7-1](#) control the generation of PARTID and PMG by the PE, according to the Exception level and configuration of MPAM. See [Versions of the MPAM Extension on page 1-22](#).

Table 7-1 Summary of System registers

op1	CRn	CRm	op2	System register	Description
0	10	5	1	MPAM0_EL1	MPAM context for EL0 execution.
0	10	5	0	MPAM1_EL1	MPAM context for EL1 execution.
4	10	5	0	MPAM2_EL2	MPAM context for EL2 execution.
6	10	5	0	MPAM3_EL3	MPAM context for EL3 execution.
5	10	5	0	MPAM1_EL12	MPAM context for EL1 execution on type-2 hypervisor.
4	10	4	0	MPAMHCR_EL2	Hypervisor configuration register for virtualization of PARTID in EL0.
4	10	4	1	MPAMVPMV_EL2	Virtual PARTID map valid bits.
4	10	6	0-7	MPAMVPM0_EL2 through MPAMVPM7_EL2	Virtual PARTID mapping for virtualization.
0	10	4	4	MPAMIDR_EL1	MPAM identification register.
0	10	4	3	MPAMSM_EL1	SME register to generate MPAM labels.

7.4 System register descriptions

This section lists the MPAM System registers in AArch64.

7.4.1 MPAM0_EL1, MPAM0 Register (EL1)

The MPAM0_EL1 characteristics are:

Purpose

Holds information to generate MPAM labels for memory requests when executing at EL0. When EL2 is implemented and enabled in the current Security state, the MPAM virtualization option is present, `MPAMHCR_EL2.GSTAPP_PLK == 1` and `HCR_EL2.TGE == 0`, `MPAM1_EL1` is used instead of `MPAM0_EL1` to generate MPAM information to label memory requests.

If EL2 is implemented and enabled in the current Security state, and `HCR_EL2.E2H == 0` or `HCR_EL2.TGE == 0`, the MPAM virtualization option is present and `MPAMHCR_EL2.EL0_VPMEN == 1`, then MPAM PARTIDs in `MPAM0_EL1` are virtual and mapped into physical PARTIDs for the current Security state.

Configurations

This register is present only when `FEAT_MPAM` is implemented. Otherwise, direct accesses to `MPAM0_EL1` are UNDEFINED.

Attributes

`MPAM0_EL1` is a 64-bit register.

Field descriptions

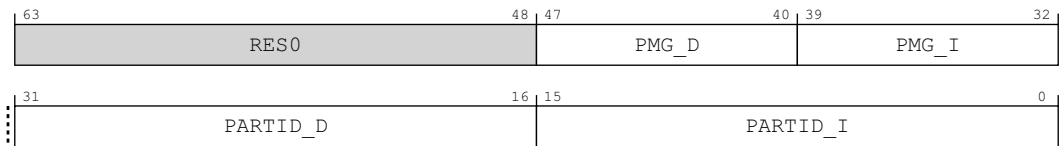

Bits [63:48]

Reserved, RES0.

PMG_D, bits [47:40]

Performance monitoring group property for `PARTID_D`.

The reset behavior of this field is:

- On a Warm reset, this field resets to an architecturally UNKNOWN value.

PMG_I, bits [39:32]

Performance monitoring group property for `PARTID_I`.

The reset behavior of this field is:

- On a Warm reset, this field resets to an architecturally UNKNOWN value.

PARTID_D, bits [31:16]

Partition ID for data accesses, including load and store accesses, made from EL0.

The reset behavior of this field is:

- On a Warm reset, this field resets to an architecturally UNKNOWN value.

PARTID_I, bits [15:0]

Partition ID for instruction accesses made from EL0.

The reset behavior of this field is:

- On a Warm reset, this field resets to an architecturally UNKNOWN value.

Accessing MPAM0_EL1

None of the fields in this register are permitted to be cached in a TLB.

Accesses to this register use the following encodings in the System register encoding space:

MRS <Xt>, MPAM0_EL1

op0	op1	CRn	CRm	op2
0b11	0b000	0b1010	0b0101	0b001

```

if PSTATE.EL == EL0 then
    UNDEFINED;
elseif PSTATE.EL == EL1 then
    if HaveEL(EL3) && MPAM3_EL3.TRAPLOWER == '1' then
        if Halted() && EDSCR.SDD == '1' then
            UNDEFINED;
        else
            AArch64.SystemAccessTrap(EL3, 0x18);
    elseif EL2Enabled() && MPAM2_EL2.TRAPMPAM0EL1 == '1' then
        AArch64.SystemAccessTrap(EL2, 0x18);
    else
        X[t, 64] = MPAM0_EL1;
elseif PSTATE.EL == EL2 then
    if HaveEL(EL3) && MPAM3_EL3.TRAPLOWER == '1' then
        if Halted() && EDSCR.SDD == '1' then
            UNDEFINED;
        else
            AArch64.SystemAccessTrap(EL3, 0x18);
    else
        X[t, 64] = MPAM0_EL1;
elseif PSTATE.EL == EL3 then
    X[t, 64] = MPAM0_EL1;

```

MSR MPAM0_EL1, <Xt>

op0	op1	CRn	CRm	op2
0b11	0b000	0b1010	0b0101	0b001

```

if PSTATE.EL == EL0 then
    UNDEFINED;
elseif PSTATE.EL == EL1 then
    if HaveEL(EL3) && MPAM3_EL3.TRAPLOWER == '1' then
        if Halted() && EDSCR.SDD == '1' then
            UNDEFINED;
        else
            AArch64.SystemAccessTrap(EL3, 0x18);
    elseif EL2Enabled() && MPAM2_EL2.TRAPMPAM0EL1 == '1' then
        AArch64.SystemAccessTrap(EL2, 0x18);
    else
        MPAM0_EL1 = X[t, 64];
elseif PSTATE.EL == EL2 then
    if HaveEL(EL3) && MPAM3_EL3.TRAPLOWER == '1' then
        if Halted() && EDSCR.SDD == '1' then
            UNDEFINED;
        else
            AArch64.SystemAccessTrap(EL3, 0x18);
    else
        MPAM0_EL1 = X[t, 64];

```

```
elseif PSTATE.EL == EL3 then  
    MPAM0_EL1 = X[t, 64];
```

7.4.2 MPAM1_EL1, MPAM1 Register (EL1)

The MPAM1_EL1 characteristics are:

Purpose

Holds information to generate MPAM labels for memory requests when executing at EL1.

When EL2 is implemented and enabled in the current Security state, the MPAM virtualization option is present, `MPAMHCR_EL2.GSTAPP_PLK == 1` and `HCR_EL2.TGE == 0`, MPAM1_EL1 is used instead of MPAM0_EL1 to generate MPAM labels for memory requests when executing at EL0.

MPAM1_EL1 is an alias for MPAM2_EL2 when executing at EL2 with `HCR_EL2.E2H == 1`.

MPAM1_EL12 is an alias for MPAM1_EL1 when executing at EL2 or EL3 with `HCR_EL2.E2H == 1`.

If EL2 is implemented and enabled in the current Security state, the MPAM virtualization option is present and `MPAMHCR_EL2.EL1_VPMEN == 1`, MPAM PARTIDs in MPAM1_EL1 are virtual and mapped into physical PARTIDs for the current Security state. This mapping of MPAM1_EL1 virtual PARTIDs to physical PARTIDs when EL1_VPMEN is 1 also applies when MPAM1_EL1 is used at EL0 due to `MPAMHCR_EL2.GSTAPP_PLK`.

Configurations

AArch64 System register MPAM1_EL1 bit [63] is architecturally mapped to AArch64 System register MPAM3_EL3[63] when EL3 is implemented.

AArch64 System register MPAM1_EL1 bit [63] is architecturally mapped to AArch64 System register MPAM2_EL2[63] when EL3 is not implemented and EL2 is implemented.

This register is present only when FEAT_MPAM is implemented. Otherwise, direct accesses to MPAM1_EL1 are UNDEFINED.

Attributes

MPAM1_EL1 is a 64-bit register.

Field descriptions

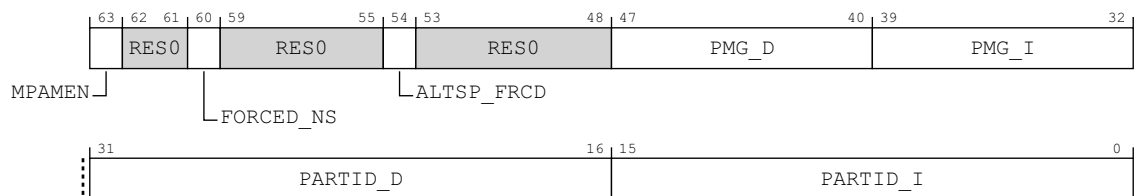

MPAMEN, bit [63]

MPAM Enable. MPAM is enabled when `MPAMEN == 1`. When disabled, all PARTIDs and PMGs are output as their default value in the corresponding ID space.

0b0 The default PARTID and default PMG are output in MPAM information.

0b1 MPAM information is output based on the MPAMn_ELx register for ELn according the MPAM configuration.

If neither EL3 nor EL2 is implemented, this field is read/write.

If EL3 is implemented, this field is read-only and reads the current value of the read/write bit `MPAM3_EL3.MPAMEN`.

If EL3 is not implemented and EL2 is implemented, this field is read-only and reads the current value of the read/write bit `MPAM2_EL2.MPAMEN`.

The reset behavior of this field is:

- On a Warm reset, this field resets to 0.

Accessing this field has the following behavior:

- RW if all of the following are true:
 - EL3 is not implemented
 - EL2 is not implemented
- Otherwise, access to this field is RO

Bits [62:61]

Reserved, RES0.

FORCED_NS, bit [60]

When FEAT_MPAMv0p1 is implemented:

In the Secure state, FORCED_NS indicates the state of [MPAM3_EL3.FORCE_NS](#).

0b0 In the Non-secure state, always reads as 0.

In the Secure state, indicates that [MPAM3_EL3.FORCE_NS](#) == 0.

0b1 In the Secure state, indicates that [MPAM3_EL3.FORCE_NS](#) == 1.

Always reads as 0 in the Non-secure state.

Writes are ignored.

Access to this field is RO.

Otherwise:

Reserved, RES0.

Bits [59:55]

Reserved, RES0.

ALTSP_FRCD, bit [54]

When FEAT_RME is implemented and MPAMIDR_EL1.HAS_ALTSP == 1:

Alternative PARTID forced for PARTIDs in this register.

0b0 The PARTIDs in [MPAM1_EL1](#) and [MPAM0_EL1](#) are using the primary PARTID space.

0b1 The PARTIDs in [MPAM1_EL1](#) and [MPAM0_EL1](#) are using the alternative PARTID space.

This bit indicates that a higher Exception level has forced the PARTIDs in this register to use the alternative PARTID space defined for the current Security state.

In [MPAM1_EL1](#), it also indicates that [MPAM0_EL1](#) is forced to use alternative PARTID space.

For more information, see 'Alternative PARTID spaces and selection' in Arm® Architecture Reference Manual Supplement, Memory System Resource Partitioning and Monitoring (MPAM), for Armv8-A (ARM DDI 0598).

Access to this field is RO.

Otherwise:

Reserved, RES0.

Bits [53:48]

Reserved, RES0.

PMG_D, bits [47:40]

Performance monitoring group property for PARTID_D.

The reset behavior of this field is:

- On a Warm reset, this field resets to an architecturally UNKNOWN value.

PMG_I, bits [39:32]

Performance monitoring group property for PARTID_I.

The reset behavior of this field is:

- On a Warm reset, this field resets to an architecturally UNKNOWN value.

PARTID_D, bits [31:16]

Partition ID for data accesses, including load and store accesses, made from EL1.

The reset behavior of this field is:

- On a Warm reset, this field resets to an architecturally UNKNOWN value.

PARTID_I, bits [15:0]

Partition ID for instruction accesses made from EL1.

The reset behavior of this field is:

- On a Warm reset, this field resets to an architecturally UNKNOWN value.

Accessing MPAM1_EL1

When HCR_EL2.E2H is 1, without explicit synchronization, accesses from EL3 using the mnemonic MPAM1_EL1 or MPAM1_EL12 are not guaranteed to be ordered with respect to accesses using the other mnemonic.

None of the fields in this register are permitted to be cached in a TLB.

Accesses to this register use the following encodings in the System register encoding space:

MRS <Xt>, MPAM1_EL1

op0	op1	CRn	CRm	op2
0b11	0b000	0b1010	0b0101	0b000

```

if PSTATE.EL == EL0 then
    UNDEFINED;
elseif PSTATE.EL == EL1 then
    if HaveEL(EL3) && MPAM3_EL3.TRAPLOWER == '1' then
        if HalTED() && EDSCR.SDD == '1' then
            UNDEFINED;
        else
            AArch64.SystemAccessTrap(EL3, 0x18);
    elseif EL2Enabled() && MPAM2_EL2.TRAPPAM1EL1 == '1' then
        AArch64.SystemAccessTrap(EL2, 0x18);
    elseif EL2Enabled() && HCR_EL2.<NV2,NV1,NV> == '111' then
        X[t, 64] = NVMem[0x900];
    else
        X[t, 64] = MPAM1_EL1;
elseif PSTATE.EL == EL2 then
    if HaveEL(EL3) && MPAM3_EL3.TRAPLOWER == '1' then
        if HalTED() && EDSCR.SDD == '1' then
            UNDEFINED;
        else
            AArch64.SystemAccessTrap(EL3, 0x18);
    elseif HCR_EL2.E2H == '1' then
        X[t, 64] = MPAM2_EL2;
    else
        X[t, 64] = MPAM1_EL1;
elseif PSTATE.EL == EL3 then
    X[t, 64] = MPAM1_EL1;

```

MSR MPAM1_EL1, <Xt>

op0	op1	CRn	CRm	op2
0b11	0b000	0b1010	0b0101	0b000

```

if PSTATE.EL == EL0 then
    UNDEFINED;
elsif PSTATE.EL == EL1 then
    if HaveEL(EL3) && MPAM3_EL3.TRAPLOWER == '1' then
        if Halted() && EDSCR.SDD == '1' then
            UNDEFINED;
        else
            AArch64.SystemAccessTrap(EL3, 0x18);
    elsif EL2Enabled() && MPAM2_EL2.TRAPMPAM1EL1 == '1' then
        AArch64.SystemAccessTrap(EL2, 0x18);
    elsif EL2Enabled() && HCR_EL2.<NV2,NV1,NV> == '111' then
        NVMem[0x900] = X[t, 64];
    else
        MPAM1_EL1 = X[t, 64];
elsif PSTATE.EL == EL2 then
    if HaveEL(EL3) && MPAM3_EL3.TRAPLOWER == '1' then
        if Halted() && EDSCR.SDD == '1' then
            UNDEFINED;
        else
            AArch64.SystemAccessTrap(EL3, 0x18);
    elsif HCR_EL2.E2H == '1' then
        MPAM2_EL2 = X[t, 64];
    else
        MPAM1_EL1 = X[t, 64];
elsif PSTATE.EL == EL3 then
    MPAM1_EL1 = X[t, 64];

```

MRS <Xt>, MPAM1_EL12

op0	op1	CRn	CRm	op2
0b11	0b101	0b1010	0b0101	0b000

```

if PSTATE.EL == EL0 then
    UNDEFINED;
elsif PSTATE.EL == EL1 then
    if EL2Enabled() && HCR_EL2.<NV2,NV1,NV> == '101' then
        X[t, 64] = NVMem[0x900];
    elsif EL2Enabled() && HCR_EL2.NV == '1' then
        if HaveEL(EL3) && MPAM3_EL3.TRAPLOWER == '1' then
            AArch64.SystemAccessTrap(EL3, 0x18);
        else
            AArch64.SystemAccessTrap(EL2, 0x18);
    else
        UNDEFINED;
elsif PSTATE.EL == EL2 then
    if HCR_EL2.E2H == '1' then
        if HaveEL(EL3) && MPAM3_EL3.TRAPLOWER == '1' then
            if Halted() && EDSCR.SDD == '1' then
                UNDEFINED;
            else
                AArch64.SystemAccessTrap(EL3, 0x18);
        else
            X[t, 64] = MPAM1_EL1;
    else
        UNDEFINED;
elsif PSTATE.EL == EL3 then

```

```

if EL2Enabled() && !ELUsingAArch32(EL2) && HCR_EL2.E2H == '1' then
    X[t, 64] = MPAM1_EL1;
else
    UNDEFINED;

```

MSR MPAM1_EL12, <Xt>

op0	op1	CRn	CRm	op2
0b11	0b101	0b1010	0b0101	0b000

```

if PSTATE.EL == EL0 then
    UNDEFINED;
elseif PSTATE.EL == EL1 then
    if EL2Enabled() && HCR_EL2.<NV2,NV1,NV> == '101' then
        NVMem[0x900] = X[t, 64];
    elseif EL2Enabled() && HCR_EL2.NV == '1' then
        if HaveEL(EL3) && MPAM3_EL3.TRAPLOWER == '1' then
            AArch64.SystemAccessTrap(EL3, 0x18);
        else
            AArch64.SystemAccessTrap(EL2, 0x18);
    else
        UNDEFINED;
elseif PSTATE.EL == EL2 then
    if HCR_EL2.E2H == '1' then
        if HaveEL(EL3) && MPAM3_EL3.TRAPLOWER == '1' then
            if Halted() && EDSCR.SDD == '1' then
                UNDEFINED;
            else
                AArch64.SystemAccessTrap(EL3, 0x18);
        else
            MPAM1_EL1 = X[t, 64];
    else
        UNDEFINED;
elseif PSTATE.EL == EL3 then
    if EL2Enabled() && !ELUsingAArch32(EL2) && HCR_EL2.E2H == '1' then
        MPAM1_EL1 = X[t, 64];
    else
        UNDEFINED;

```

7.4.3 MPAM2_EL2, MPAM2 Register (EL2)

The MPAM2_EL2 characteristics are:

Purpose

Holds information to generate MPAM labels for memory requests when executing at EL2.

Configurations

AArch64 System register MPAM2_EL2 bit [63] is architecturally mapped to AArch64 System register [MPAM3_EL3](#)[63] when EL3 is implemented.

AArch64 System register MPAM2_EL2 bit [63] is architecturally mapped to AArch64 System register [MPAM1_EL1](#)[63].

This register is present only when FEAT_MPAM is implemented. Otherwise, direct accesses to MPAM2_EL2 are UNDEFINED.

This register has no effect if EL2 is not enabled in the current Security state.

Attributes

MPAM2_EL2 is a 64-bit register.

Field descriptions

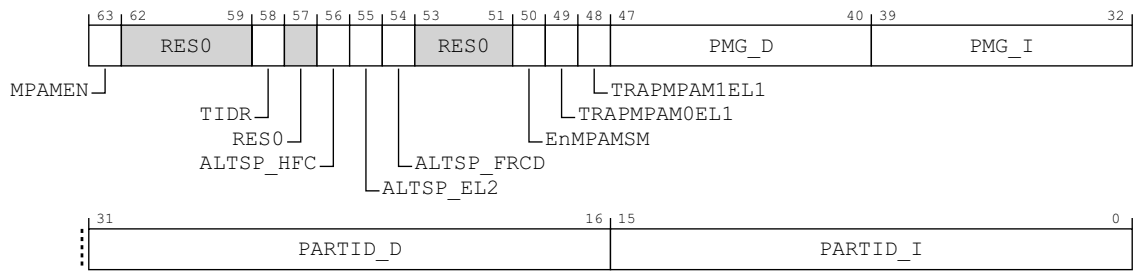

MPAMEN, bit [63]

MPAM Enable. MPAM is enabled when MPAMEN == 1. When disabled, all PARTIDs and PMGs are output as their default value in the corresponding ID space.

- 0b0 The default PARTID and default PMG are output in MPAM information from all Exception levels.
- 0b1 MPAM information is output based on the MPAMn_ELx register for ELn according to the MPAM configuration.

If EL3 is not implemented, this field is read/write.

If EL3 is implemented, this field is read-only and reads the current value of the read/write [MPAM3_EL3](#).MPAMEN bit.

The reset behavior of this field is:

- On a Warm reset, this field resets to 0.

Accessing this field has the following behavior:

- When EL3 is not implemented, access to this field is RW.
- Otherwise, access to this field is RO

Bits [62:59]

Reserved, RES0.

TIDR, bit [58]

When (FEAT_MPAMv0p1 is implemented or FEAT_MPAMv1p1 is implemented) and MPAMIDR_EL1.HAS_TIDR == 1:

TIDR traps accesses to MPAMIDR_EL1 from EL1 to EL2.

0b0 This control does not cause any instructions to be trapped.

0b1 Trap accesses to MPAMIDR_EL1 from EL1 to EL2.

MPAMHCR_EL2.TRAP_MPAMIDR_EL1 == 1 also traps MPAMIDR_EL1 accesses from EL1 to EL2. If either TIDR or TRAP_MPAMIDR_EL1 are 1, accesses are trapped.

The reset behavior of this field is:

- On a Warm reset, this field resets to an architecturally UNKNOWN value.

Otherwise:

Reserved, RES0.

Bit [57]

Reserved, RES0.

ALTSP_HFC, bit [56]

When FEAT_RME is implemented and MPAMIDR_EL1.HAS_ALTSP == 1:

Hierarchical force of alternative PARTID space controls. When MPAM3_EL3.ALTSP_HEN is 0, ALTSP controls in MPAM2_EL2 have no effect. When MPAM3_EL3.ALTSP_HEN is 1, this bit selects whether the PARTIDs in MPAM1_EL1 and MPAM0_EL1 are in the primary (0) or alternative (1) PARTID space for the security state.

0b0 When MPAM3_EL3.ALTSP_HEN is 1, the PARTID space of MPAM1_EL1.PARTID_I, MPAM1_EL1.PARTID_D, MPAM0_EL1.PARTID_I, and MPAM0_EL1.PARTID_D are in the primary PARTID space for the Security state.

0b1 When MPAM3_EL3.ALTSP_HEN is 1, the PARTID space of MPAM1_EL1.PARTID_I, MPAM1_EL1.PARTID_D, MPAM0_EL1.PARTID_I, and MPAM0_EL1.PARTID_D are in the alternative PARTID space for the Security state.

This control has no effect when MPAM3_EL3.ALTSP_HEN is 0.

For more information, see 'Alternative PARTID spaces and selection' in Arm® Architecture Reference Manual Supplement, Memory System Resource Partitioning and Monitoring (MPAM), for Armv8-A (ARM DDI 0598).

The reset behavior of this field is:

- On a Warm reset, this field resets to an architecturally UNKNOWN value.

Otherwise:

Reserved, RES0.

ALTSP_EL2, bit [55]

When FEAT_RME is implemented and MPAMIDR_EL1.HAS_ALTSP == 1:

Select alternative PARTID space for PARTIDs in MPAM2_EL2 when MPAM3_EL3.ALTSP_HEN is 1.

0b0 When MPAM3_EL3.ALTSP_HEN is 1, selects the primary PARTID space for MPAM2_EL2.PARTID_I and MPAM2_EL2.PARTID_D.

0b1 When MPAM3_EL3.ALTSP_HEN is 1, selects the alternative PARTID space for MPAM2_EL2.PARTID_I and MPAM2_EL2.PARTID_D.

For more information, see 'Alternative PARTID spaces and selection' in Arm® Architecture Reference Manual Supplement, Memory System Resource Partitioning and Monitoring (MPAM), for Armv8-A (ARM DDI 0598).

The reset behavior of this field is:

- On a Warm reset, this field resets to an architecturally UNKNOWN value.

Otherwise:

Reserved, RES0.

ALTSP_FRCD, bit [54]

When FEAT_RME is implemented and MPAMIDR_EL1.HAS_ALTSP == 1:

Alternative PARTID forced for PARTIDs in this register.

0b0 The PARTIDs in this register are using the primary PARTID space.

0b1 The PARTIDs in this register are using the alternative PARTID space.

This bit indicates that a higher Exception level has forced the PARTIDs in this register to use the alternative PARTID space defined for the current Security state. In EL2, it is also 1 when MPAM2_EL2.ALTSP_EL2 is 1.

For more information, see 'Alternative PARTID spaces and selection' in Arm® Architecture Reference Manual Supplement, Memory System Resource Partitioning and Monitoring (MPAM), for Armv8-A (ARM DDI 0598).

The reset behavior of this field is:

- On a Warm reset, this field resets to an architecturally UNKNOWN value.

Access to this field is RO.

Otherwise:

Reserved, RES0.

Bits [53:51]

Reserved, RES0.

EnMPAMSM, bit [50]

When FEAT_SME is implemented:

Traps execution at EL1 of instructions that directly access the [MPAMSM_EL1](#) register to EL2. The exception is reported using ESR_ELx.EC value 0x18.

0b0 This control causes execution of these instructions at EL1 to be trapped.

0b1 This control does not cause execution of any instructions to be trapped.

This field has no effect on accesses to [MPAMSM_EL1](#) from EL2 or EL3.

The reset behavior of this field is:

- On a Warm reset, this field resets to an architecturally UNKNOWN value.

Otherwise:

Reserved, RES0.

TRAPMPAM0EL1, bit [49]

Trap accesses from EL1 to the [MPAM0_EL1](#) register trap to EL2.

0b0 Accesses to [MPAM0_EL1](#) from EL1 are not trapped.

0b1 Accesses to [MPAM0_EL1](#) from EL1 are trapped to EL2.

The reset behavior of this field is:

- On a Warm reset:
 - When EL3 is not implemented, this field resets to 1.
 - When EL3 is implemented, this field resets to an architecturally UNKNOWN value.

TRAPMPAM1EL1, bit [48]

Trap accesses from EL1 to the [MPAM1_EL1](#) register trap to EL2.

0b0 Accesses to [MPAM1_EL1](#) from EL1 are not trapped.

0b1 Accesses to [MPAM1_EL1](#) from EL1 are trapped to EL2.

The reset behavior of this field is:

- On a Warm reset:
 - When EL3 is not implemented, this field resets to 1.
 - When EL3 is implemented, this field resets to an architecturally UNKNOWN value.

PMG_D, bits [47:40]

Performance monitoring group for data accesses.

The reset behavior of this field is:

- On a Warm reset, this field resets to an architecturally UNKNOWN value.

PMG_I, bits [39:32]

Performance monitoring group for instruction accesses.

The reset behavior of this field is:

- On a Warm reset, this field resets to an architecturally UNKNOWN value.

PARTID_D, bits [31:16]

Partition ID for data accesses, including load and store accesses, made from EL2.

The reset behavior of this field is:

- On a Warm reset, this field resets to an architecturally UNKNOWN value.

PARTID_I, bits [15:0]

Partition ID for instruction accesses made from EL2.

The reset behavior of this field is:

- On a Warm reset, this field resets to an architecturally UNKNOWN value.

Accessing MPAM2_EL2

None of the fields in this register are permitted to be cached in a TLB.

Accesses to this register use the following encodings in the System register encoding space:

MRS <Xt>, MPAM2_EL2

op0	op1	CRn	CRm	op2
0b11	0b100	0b1010	0b0101	0b000

```

if PSTATE.EL == EL0 then
    UNDEFINED;
elseif PSTATE.EL == EL1 then
    if EL2Enabled() && HCR_EL2.NV == '1' then
        if HaveEL(EL3) && MPAM3_EL3.TRAPLOWER == '1' then
            if Halted() && EDSCR.SDD == '1' then
                UNDEFINED;
            else
                AArch64.SystemAccessTrap(EL3, 0x18);
        else
            AArch64.SystemAccessTrap(EL2, 0x18);
    else
        UNDEFINED;
elseif PSTATE.EL == EL2 then
    if HaveEL(EL3) && MPAM3_EL3.TRAPLOWER == '1' then
        if Halted() && EDSCR.SDD == '1' then
            UNDEFINED;
        else
            AArch64.SystemAccessTrap(EL3, 0x18);
    else

```

```

        X[t, 64] = MPAM2_EL2;
    elsif PSTATE.EL == EL3 then
        X[t, 64] = MPAM2_EL2;

```

MSR MPAM2_EL2, <Xt>

op0	op1	CRn	CRm	op2
0b11	0b100	0b1010	0b0101	0b000

```

if PSTATE.EL == EL0 then
    UNDEFINED;
elsif PSTATE.EL == EL1 then
    if EL2Enabled() && HCR_EL2.NV == '1' then
        if HaveEL(EL3) && MPAM3_EL3.TRAPLOWER == '1' then
            if Halted() && EDSCR.SDD == '1' then
                UNDEFINED;
            else
                AArch64.SystemAccessTrap(EL3, 0x18);
        else
            AArch64.SystemAccessTrap(EL2, 0x18);
    else
        UNDEFINED;
elsif PSTATE.EL == EL2 then
    if HaveEL(EL3) && MPAM3_EL3.TRAPLOWER == '1' then
        if Halted() && EDSCR.SDD == '1' then
            UNDEFINED;
        else
            AArch64.SystemAccessTrap(EL3, 0x18);
    else
        MPAM2_EL2 = X[t, 64];
elsif PSTATE.EL == EL3 then
    MPAM2_EL2 = X[t, 64];

```

MRS <Xt>, MPAM1_EL1

op0	op1	CRn	CRm	op2
0b11	0b000	0b1010	0b0101	0b000

```

if PSTATE.EL == EL0 then
    UNDEFINED;
elsif PSTATE.EL == EL1 then
    if HaveEL(EL3) && MPAM3_EL3.TRAPLOWER == '1' then
        if Halted() && EDSCR.SDD == '1' then
            UNDEFINED;
        else
            AArch64.SystemAccessTrap(EL3, 0x18);
    elsif EL2Enabled() && MPAM2_EL2.TRAPMPAM1EL1 == '1' then
        AArch64.SystemAccessTrap(EL2, 0x18);
    elsif EL2Enabled() && HCR_EL2.<NV2,NV1,NV> == '111' then
        X[t, 64] = NVMem[0x900];
    else
        X[t, 64] = MPAM1_EL1;
elsif PSTATE.EL == EL2 then
    if HaveEL(EL3) && MPAM3_EL3.TRAPLOWER == '1' then
        if Halted() && EDSCR.SDD == '1' then
            UNDEFINED;
        else
            AArch64.SystemAccessTrap(EL3, 0x18);
    elsif HCR_EL2.E2H == '1' then
        X[t, 64] = MPAM2_EL2;

```



```

else
    X[t, 64] = MPAM1_EL1;
elseif PSTATE.EL == EL3 then
    X[t, 64] = MPAM1_EL1;

```

MSR MPAM1_EL1, <Xt>

op0	op1	CRn	CRm	op2
0b11	0b000	0b1010	0b0101	0b000

```

if PSTATE.EL == EL0 then
    UNDEFINED;
elseif PSTATE.EL == EL1 then
    if HaveEL(EL3) && MPAM3_EL3.TRAPLOWER == '1' then
        if Halted() && EDSCR.SDD == '1' then
            UNDEFINED;
        else
            AArch64.SystemAccessTrap(EL3, 0x18);
    elseif EL2Enabled() && MPAM2_EL2.TRAPMPAM1EL1 == '1' then
        AArch64.SystemAccessTrap(EL2, 0x18);
    elseif EL2Enabled() && HCR_EL2.<NV2,NV1,NV> == '111' then
        NVMem[0x900] = X[t, 64];
    else
        MPAM1_EL1 = X[t, 64];
elseif PSTATE.EL == EL2 then
    if HaveEL(EL3) && MPAM3_EL3.TRAPLOWER == '1' then
        if Halted() && EDSCR.SDD == '1' then
            UNDEFINED;
        else
            AArch64.SystemAccessTrap(EL3, 0x18);
    elseif HCR_EL2.E2H == '1' then
        MPAM2_EL2 = X[t, 64];
    else
        MPAM1_EL1 = X[t, 64];
elseif PSTATE.EL == EL3 then
    MPAM1_EL1 = X[t, 64];

```

7.4.4 MPAM3_EL3, MPAM3 Register (EL3)

The MPAM3_EL3 characteristics are:

Purpose

Holds information to generate MPAM labels for memory requests when executing at EL3.

Configurations

AArch64 System register MPAM3_EL3 bit [63] is architecturally mapped to AArch64 System register [MPAM2_EL2](#)[63] when EL2 is implemented.

AArch64 System register MPAM3_EL3 bit [63] is architecturally mapped to AArch64 System register [MPAM1_EL1](#)[63].

This register is present only when FEAT_MPAM is implemented. Otherwise, direct accesses to MPAM3_EL3 are UNDEFINED.

Attributes

MPAM3_EL3 is a 64-bit register.

Field descriptions

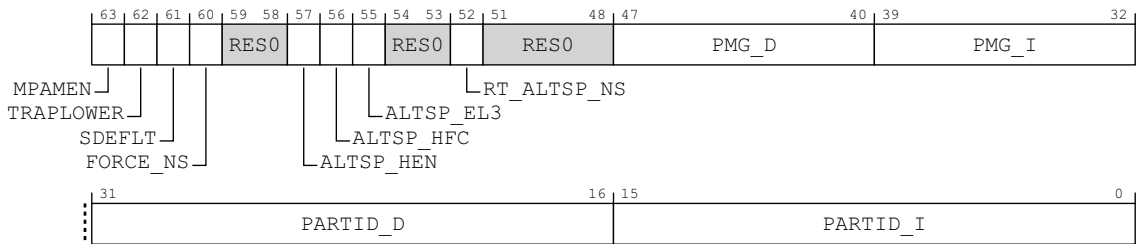

MPAMEN, bit [63]

MPAM Enable. MPAM is enabled when MPAMEN == 1. When disabled, all PARTIDs and PMGs are output as their default value in the corresponding ID space.

Values of this field are:

- 0b0 The default PARTID and default PMG are output in MPAM information when executing at any ELn.
- 0b1 MPAM information is output based on the MPAMn_ELx register for ELn according to the MPAM configuration.

The reset behavior of this field is:

- On a Warm reset, this field resets to 0.

Access to this field is RW.

TRAPLOWER, bit [62]

Trap direct accesses to MPAM System registers that are not UNDEFINED from all ELn lower than EL3.

- 0b0 Do not force trapping of direct accesses of MPAM System registers to EL3.
- 0b1 Force direct accesses of MPAM System registers to trap to EL3.

The reset behavior of this field is:

- On a Warm reset, this field resets to 1.

SDEFLT, bit [61]

When (FEAT_MPAMv0p1 is implemented or FEAT_MPAMv1p1 is implemented) and MPAMIDR_EL1.HAS_SDEFLT == 1:

SDEFLT overrides the PARTID and PMG with the default PARTID and default PMG when executing in the Secure state.

- 0b0 The PARTID and PMG are determined normally in the Secure state.
- 0b1 When executing in the Secure state, the PARTID is always PARTID 0, and the PMG is always PMG 0.

The reset behavior of this field is:

- On a Warm reset, this field resets to an architecturally UNKNOWN value.

Otherwise:

Reserved, RES0.

FORCE_NS, bit [60]

When FEAT_MPAMv0p1 is implemented and MPAMIDR_EL1.HAS_FORCE_NS == 1:

FORCE_NS forces MPAM_NS to always be 1 in the Secure state.

- 0b0 MPAM_NS is 0 when executing in the Secure state.
- 0b1 MPAM_NS is 1 when executing in the Secure state.

An implementation is permitted to have this field as RAO if the implementation does not support generating MPAM_NS as 0.

The reset behavior of this field is:

- On a Warm reset, this field resets to an architecturally UNKNOWN value.

Otherwise:

Reserved, RES0.

Bits [59:58]

Reserved, RES0.

ALTSP_HEN, bit [57]

When FEAT_RME is implemented and MPAMIDR_EL1.HAS_ALTSP == 1:

Hierarchical enable for alternative PARTID space controls. Alternative PARTID space controls in [MPAM2_EL2](#) have no effect when this field is zero.

- 0b0 Disable alternative PARTID space controls in [MPAM2_EL2](#). The PARTID space for PARTIDs in [MPAM2_EL2](#), [MPAM1_EL1](#), and [MPAM0_EL1](#) is selected by [MPAM3_EL3.ALTSP_HFC](#).
- 0b1 Enable alternative PARTID space controls in [MPAM2_EL2](#) to control the PARTID space used for PARTIDs in [MPAM2_EL2](#), [MPAM1_EL1](#), and [MPAM0_EL1](#).

For more information, see 'Alternative PARTID spaces and selection' in Arm® Architecture Reference Manual Supplement, Memory System Resource Partitioning and Monitoring (MPAM), for Armv8-A (ARM DDI 0598).

The reset behavior of this field is:

- On a Warm reset, this field resets to an architecturally UNKNOWN value.

Otherwise:

Reserved, RES0.

ALTSP_HFC, bit [56]

When FEAT_RME is implemented and MPAMIDR_EL1.HAS_ALTSP == 1:

Hierarchical force of alternative PARTID space controls. When MPAM3_EL3.ALTSP_HEN is 0, the PARTID space for PARTIDs in MPAM2_EL2, MPAM1_EL1, and MPAM0_EL1 is selected by the value of this bit.

- 0b0 When MPAM3_EL3.ALTSP_HEN is 0, the PARTID space of MPAM2_EL2.PARTID, MPAM1_EL1.PARTID and MPAM0_EL1.PARTID are the primary PARTID space for the security state.
- 0b1 When MPAM3_EL3.ALTSP_HEN is 0, the PARTID space of MPAM2_EL2.PARTID and MPAM1_EL1.PARTID and MPAM0_EL1.PARTID are the alternative PARTID space for the security state.

For more information, see 'Alternative PARTID spaces and selection' in Arm® Architecture Reference Manual Supplement, Memory System Resource Partitioning and Monitoring (MPAM), for Armv8-A (ARM DDI 0598).

The reset behavior of this field is:

- On a Warm reset, this field resets to an architecturally UNKNOWN value.

Otherwise:

Reserved, RES0.

ALTSP_EL3, bit [55]

When FEAT_RME is implemented and MPAMIDR_EL1.HAS_ALTSP == 1:

Select alternative PARTID space for PARTIDs in MPAM3_EL3.

- 0b0 Selects the primary PARTID space of MPAM3_EL3.PARTID_I and MPAM3_EL3.PARTID_D.
- 0b1 Selects the alternative PARTID space of MPAM3_EL3.PARTID_I and MPAM3_EL3.PARTID_D.

For more information, see 'Alternative PARTID spaces and selection' in Arm® Architecture Reference Manual Supplement, Memory System Resource Partitioning and Monitoring (MPAM), for Armv8-A (ARM DDI 0598).

The reset behavior of this field is:

- On a Warm reset, this field resets to an IMPLEMENTATION DEFINED value.

Otherwise:

Reserved, RES0.

Bits [54:53]

Reserved, RES0.

RT_ALTSP_NS, bit [52]

When FEAT_RME is implemented and MPAMIDR_EL1.HAS_ALTSP == 1:

Selects whether the alternative PARTID space for the Root security state is the Secure PARTID space or the Non-secure PARTID space. MPAM3_EL3.RT_ALTSP_NS selects the alternative PARTID space for the Root Security state when MPAM3_EL3.ALTSP_EL3 == 1.

- 0b0 The alternative PARTID space in the Root security state is the Secure PARTID space.
- 0b1 The alternative PARTID space in the Root security state is the Non-secure PARTID space.

This field has no effect except in the Root security state (EL3).

The reset behavior of this field is:

- On a Warm reset, this field resets to an IMPLEMENTATION DEFINED value.

Otherwise:

Reserved, RES0.

Bits [51:48]

Reserved, RES0.

PMG_D, bits [47:40]

Performance monitoring group for data accesses.

The reset behavior of this field is:

- On a Warm reset, this field resets to an architecturally UNKNOWN value.

PMG_I, bits [39:32]

Performance monitoring group for instruction accesses.

The reset behavior of this field is:

- On a Warm reset, this field resets to an architecturally UNKNOWN value.

PARTID_D, bits [31:16]

Partition ID for data accesses, including load and store accesses, made from EL3.

The reset behavior of this field is:

- On a Warm reset, this field resets to an architecturally UNKNOWN value.

PARTID_I, bits [15:0]

Partition ID for instruction accesses made from EL3.

The reset behavior of this field is:

- On a Warm reset, this field resets to an architecturally UNKNOWN value.

Accessing MPAM3_EL3

None of the fields in this register are permitted to be cached in a TLB.

Accesses to this register use the following encodings in the System register encoding space:

MRS <Xt>, MPAM3_EL3

op0	op1	CRn	CRm	op2
0b11	0b110	0b1010	0b0101	0b000

```
if PSTATE.EL == EL0 then
    UNDEFINED;
elseif PSTATE.EL == EL1 then
    UNDEFINED;
elseif PSTATE.EL == EL2 then
    UNDEFINED;
elseif PSTATE.EL == EL3 then
    X[t, 64] = MPAM3_EL3;
```

MSR MPAM3_EL3, <Xt>

op0	op1	CRn	CRm	op2
0b11	0b110	0b1010	0b0101	0b000

```
if PSTATE.EL == EL0 then
    UNDEFINED;
elseif PSTATE.EL == EL1 then
    UNDEFINED;
elseif PSTATE.EL == EL2 then
```

```
    UNDEFINED;  
elseif PSTATE.EL == EL3 then  
    MPAM3_EL3 = X[t, 64];
```

7.4.5 MPAMHCR_EL2, MPAM Hypervisor Control Register (EL2)

The MPAMHCR_EL2 characteristics are:

Purpose

Controls the PARTID virtualization features of MPAM. It controls the mapping of virtual PARTIDs into physical PARTIDs in [MPAM0_EL1](#) when `EL0_VPMEN == 1` and in [MPAM1_EL1](#) when `EL1_VPMEN == 1`.

Configurations

This register is present only when `FEAT_MPAM` is implemented and `MPAMIDR_EL1.HAS_HCR == 1`. Otherwise, direct accesses to `MPAMHCR_EL2` are UNDEFINED.

This register has no effect if EL2 is not enabled in the current Security state.

Attributes

`MPAMHCR_EL2` is a 64-bit register.

Field descriptions

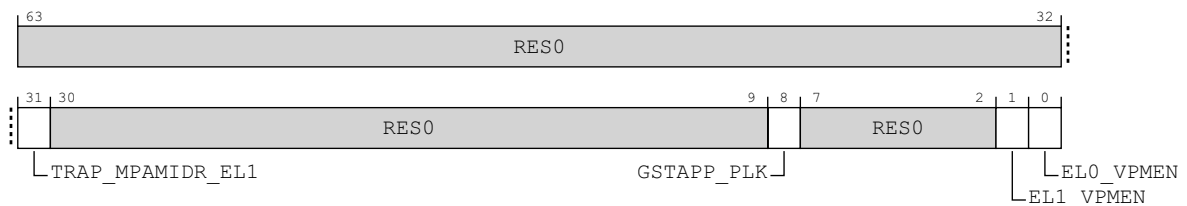

Bits [63:32]

Reserved, RES0.

TRAP_MPAMIDR_EL1, bit [31]

Trap accesses from EL1 to [MPAMIDR_EL1](#) to EL2.

0b0 This control does not cause any instructions to be trapped.

0b1 Direct accesses to [MPAMIDR_EL1](#) from EL1 are trapped to EL2.

The reset behavior of this field is:

- On a Warm reset:
 - When EL3 is not implemented, this field resets to 1.
 - When EL3 is implemented, this field resets to an architecturally UNKNOWN value.

Bits [30:9]

Reserved, RES0.

GSTAPP_PLK, bit [8]

Make the PARTIDs at EL0 the same as the PARTIDs at EL1. When executing at EL0, EL2 is enabled, `HCR_EL2.TGE == 0` and `GSTAPP_PLK = 1`, [MPAM1_EL1](#) is used instead of [MPAM0_EL1](#) to generate MPAM labels for memory requests.

0b0 [MPAM0_EL1](#) is used to generate MPAM labels when executing at EL0.

0b1 [MPAM1_EL1](#) is used to generate MPAM labels when executing at EL0 with EL2 enabled and `HCR_EL2.TGE == 0`. Otherwise [MPAM0_EL1](#) is used.

The reset behavior of this field is:

- On a Warm reset, this field resets to an architecturally UNKNOWN value.

Bits [7:2]

Reserved, RES0.

EL1_VPMEN, bit [1]

Enable the virtual PARTID mapping of the PARTID fields in MPAM1_EL1 when executing at EL1. This bit also enables virtual PARTID mapping when MPAM1_EL1 is used to generate MPAM labels for memory requests at EL0 due to GSTAPP_PLK == 1.

0b0 MPAM1_EL1.PARTID_I and MPAM1_EL1.PARTID_D are physical PARTIDs that are used to label memory system requests.

0b1 MPAM1_EL1.PARTID_I and MPAM1_EL1.PARTID_D are virtual PARTIDs that are used to index the PhyPARTID fields of MPAMVPM0_EL2 to MPAMVPM7_EL2 registers to map the virtual PARTID into a physical PARTID to label memory system requests.

The reset behavior of this field is:

- On a Warm reset, this field resets to an architecturally UNKNOWN value.

EL0_VPMEN, bit [0]

Enable the virtual PARTID mapping of the PARTID fields of MPAM0_EL1 unless HCR_EL2.E2H == 1 and HCR_EL2.TGE == 1.

When HCR_EL2.E2H == 1 and HCR_EL2.TGE == 1, EL0_VPMEN is ignored and MPAM0_EL1 PARTID fields are not mapped.

When MPAMHCR_EL2.GSTAPP_PLK == 1 and HCR_EL2.TGE == 0, MPAM1_EL1 is used as the source of PARTIDs and the virtual PARTID mapping of MPAM1_EL1 PARTIDs is controlled by MPAMHCR_EL2.EL1_VPMEN.

0b0 MPAM0_EL1.PARTID_I and MPAM0_EL1.PARTID_D are physical PARTIDs that are used to label memory system requests.

0b1 MPAM0_EL1.PARTID_I and MPAM0_EL1.PARTID_D are virtual PARTIDs that are used to index the PhyPARTID fields of MPAMVPM0_EL2 to MPAMVPM7_EL2 registers to map the virtual PARTID into a physical PARTID to label memory system requests.

The reset behavior of this field is:

- On a Warm reset, this field resets to an architecturally UNKNOWN value.

Accessing MPAMHCR_EL2

Accesses to this register use the following encodings in the System register encoding space:

MRS <Xt>, MPAMHCR_EL2

op0	op1	CRn	CRm	op2
0b11	0b100	0b1010	0b0100	0b000

```

if PSTATE.EL == EL0 then
    UNDEFINED;
elseif PSTATE.EL == EL1 then
    if EL2Enabled() && HCR_EL2.<NV2,NV> == '11' then
        X[t, 64] = NVMem[0x930];
    elseif EL2Enabled() && HCR_EL2.NV == '1' then
        if HaveEL(EL3) && MPAM3_EL3.TRAPLOWER == '1' then
            if Halted() && EDSCR.SDD == '1' then
                UNDEFINED;
            else
                AArch64.SystemAccessTrap(EL3, 0x18);
        else
            AArch64.SystemAccessTrap(EL2, 0x18);
    end
end

```



```

else
    UNDEFINED;
elseif PSTATE.EL == EL2 then
    if HaveEL(EL3) && MPAM3_EL3.TRAPLOWER == '1' then
        if HalTED() && EDSCR.SDD == '1' then
            UNDEFINED;
        else
            AArch64.SystemAccessTrap(EL3, 0x18);
    else
        X[t, 64] = MPAMHCR_EL2;
elseif PSTATE.EL == EL3 then
    X[t, 64] = MPAMHCR_EL2;

```

MSR MPAMHCR_EL2, <Xt>

op0	op1	CRn	CRm	op2
0b11	0b100	0b1010	0b0100	0b000

```

if PSTATE.EL == EL0 then
    UNDEFINED;
elseif PSTATE.EL == EL1 then
    if EL2Enabled() && HCR_EL2.<NV2,NV> == '11' then
        NVMem[0x930] = X[t, 64];
    elseif EL2Enabled() && HCR_EL2.NV == '1' then
        if HaveEL(EL3) && MPAM3_EL3.TRAPLOWER == '1' then
            if HalTED() && EDSCR.SDD == '1' then
                UNDEFINED;
            else
                AArch64.SystemAccessTrap(EL3, 0x18);
        else
            AArch64.SystemAccessTrap(EL2, 0x18);
    else
        UNDEFINED;
elseif PSTATE.EL == EL2 then
    if HaveEL(EL3) && MPAM3_EL3.TRAPLOWER == '1' then
        if HalTED() && EDSCR.SDD == '1' then
            UNDEFINED;
        else
            AArch64.SystemAccessTrap(EL3, 0x18);
    else
        MPAMHCR_EL2 = X[t, 64];
elseif PSTATE.EL == EL3 then
    MPAMHCR_EL2 = X[t, 64];

```

7.4.6 MPAMIDR_EL1, MPAM ID Register (EL1)

The MPAMIDR_EL1 characteristics are:

Purpose

Indicates the presence and maximum PARTID and PMG values supported in the implementation. It also indicates whether the implementation supports MPAM virtualization.

Configurations

This register is present only when FEAT_MPAM is implemented. Otherwise, direct accesses to MPAMIDR_EL1 are UNDEFINED.

Attributes

MPAMIDR_EL1 is a 64-bit register.

Field descriptions

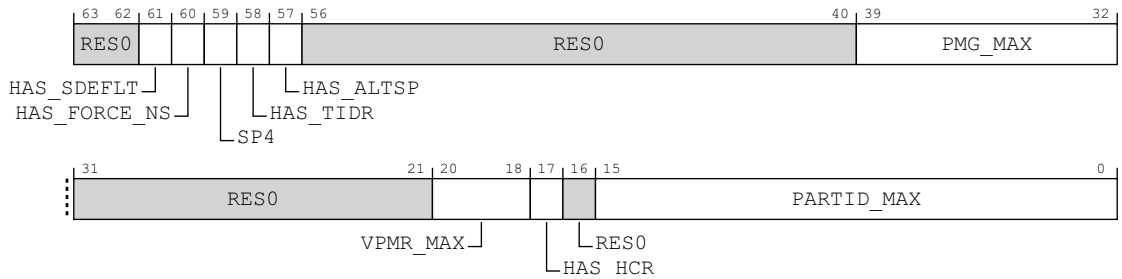

MPAMIDR_EL1 indicates the MPAM implementation parameters of the PE.

Bits [63:62]

Reserved, RES0.

HAS_SDEFLT, bit [61]

HAS_SDEFLT indicates support for [MPAM3_EL3.SDEFLT](#) bit. Defined values are:

- 0b0 The SDEFLT bit is not implemented in [MPAM3_EL3](#).
- 0b1 The SDEFLT bit is implemented in [MPAM3_EL3](#).

When [MPAM3_EL3.SDEFLT](#) == 1, accesses from the Secure Execution state use the default PARTID, PARTID == 0.

HAS_FORCE_NS, bit [60]

HAS_FORCE_NS indicates support for [MPAM3_EL3.FORCE_NS](#) bit. Defined values are:

- 0b0 The FORCE_NS bit is not implemented in [MPAM3_EL3](#).
- 0b1 The FORCE_NS bit is implemented in [MPAM3_EL3](#).

When [MPAM3_EL3.FORCE_NS](#) == 1, accesses from the Secure Execution state have MPAM_NS == 1.

SP4, bit [59]

Supports 4 MPAM PARTID spaces.

- 0b0 MPAM supports 2 PARTID spaces.
- 0b1 MPAM supports 4 PARTID spaces.

HAS_TIDR, bit [58]

HAS_TIDR indicates support for [MPAM2_EL2.TIDR](#) bit. Defined values are:

- 0b0 The TIDR bit is not implemented in [MPAM2_EL2](#).
- 0b1 The TIDR bit is implemented in [MPAM2_EL2](#).

———— Note —————

Arm recommends that when the MPAM version is MPAM v0.1 or MPAM v1.1, MPAMIDR_EL1.HAS_TIDR is 1 and that the MPAM2_EL2.TIDR field is implemented.

HAS_ALTSP, bit [57]

HAS_ALTSP indicates support for alternative PARTID spaces.

- 0b0 Alternative PARTID spaces are not implemented.
- 0b1 Alternative PARTID spaces are implemented with control bits in [MPAM3_EL3](#) and [MPAM2_EL2](#).

Bits [56:40]

Reserved, RES0.

PMG_MAX, bits [39:32]

The largest value of PMG that the implementation can generate. The PMG_I and PMG_D fields of every MPAMn_ELx must implement at least enough bits to represent PMG_MAX.

Bits [31:21]

Reserved, RES0.

VPMR_MAX, bits [20:18]

When MPAMIDR_EL1.HAS_HCR == 1:

Indicates the maximum register index n for the MPAMVPM<n>_EL2 registers.

Otherwise:

Reserved, RAZ.

HAS_HCR, bit [17]

HAS_HCR indicates that the PE implementation supports MPAM virtualization, including [MPAMHCR_EL2](#), [MPAMVPMV_EL2](#), and MPAMVPM<n>_EL2 with n in the range 0 to VPMR_MAX. Must be 0 if EL2 is not implemented in either Security state.

- 0b0 MPAM virtualization is not supported.
- 0b1 MPAM virtualization is supported.

Bit [16]

Reserved, RES0.

PARTID_MAX, bits [15:0]

The largest value of PARTID that the implementation can generate. The PARTID_I and PARTID_D fields of every MPAMn_ELx must implement at least enough bits to represent PARTID_MAX.

Accessing MPAMIDR_EL1

Accesses to this register use the following encodings in the System register encoding space:

MRS <Xt>, MPAMIDR_EL1

op0	op1	CRn	CRm	op2
0b11	0b000	0b1010	0b0100	0b100

```

if PSTATE.EL == EL0 then
    UNDEFINED;
elsif PSTATE.EL == EL1 then
    if HaveEL(EL3) && MPAM3_EL3.TRAPLOWER == '1' then
        if HalTED() && EDSCR.SDD == '1' then
            UNDEFINED;
        else
            AArch64.SystemAccessTrap(EL3, 0x18);
    elsif EL2Enabled() && MPAMIDR_EL1.HAS_HCR == '1' && MPAMHCR_EL2.TRAP_MPAMIDR_EL1 == '1' then
        AArch64.SystemAccessTrap(EL2, 0x18);
    elsif EL2Enabled() && MPAMIDR_EL1.HAS_TIDR == '1' && MPAM2_EL2.TIDR == '1' then
        AArch64.SystemAccessTrap(EL2, 0x18);
    else
        X[t, 64] = MPAMIDR_EL1;
    elsif PSTATE.EL == EL2 then
        if HaveEL(EL3) && MPAM3_EL3.TRAPLOWER == '1' then
            if HalTED() && EDSCR.SDD == '1' then
                UNDEFINED;
            else
                AArch64.SystemAccessTrap(EL3, 0x18);
        else
            X[t, 64] = MPAMIDR_EL1;
    elsif PSTATE.EL == EL3 then
        X[t, 64] = MPAMIDR_EL1;

```

7.4.7 MPAMSM_EL1, MPAM Streaming Mode Register

The MPAMSM_EL1 characteristics are:

Purpose

Holds information to generate MPAM labels for memory requests that are:

- Issued due to the execution of SME load and store instructions.
- Issued when the PE is in Streaming SVE mode due to the execution of SVE and SIMD&FP load and store instructions and SVE prefetch instructions.

If an implementation uses a shared SMCU, then the MPAM labels in this register have precedence over the labels in [MPAM0_EL1](#), [MPAM1_EL1](#), [MPAM2_EL2](#), and [MPAM3_EL3](#).

If an implementation includes an SMCU that is not shared with other PEs, then it is IMPLEMENTATION DEFINED whether the MPAM labels in this register have precedence over the labels in [MPAM0_EL1](#), [MPAM1_EL1](#), [MPAM2_EL2](#), and [MPAM3_EL3](#).

The MPAM labels in this register are only used if [MPAM1_EL1.MPAMEN](#) is 1.

For memory requests issued from EL0, the MPAM PARTID in this register is virtual and mapped into a physical PARTID when all of the following are true:

- EL2 is implemented and enabled in the current Security state, and [HCR_EL2.{E2H, TGE}](#) is not {1, 1}.
- The MPAM virtualization option is implemented and [MPAMHCR_EL2.EL0_VPMEN](#) is 1.

For memory requests issued from EL1, the MPAM PARTID in this register is virtual and mapped into a physical PARTID when all of the following are true:

- EL2 is implemented and enabled in the current Security state.
- The MPAM virtualization option is implemented and [MPAMHCR_EL2.EL1_VPMEN](#) is 1.

Configurations

This register is present only when [FEAT_MPAM](#) is implemented and [FEAT_SME](#) is implemented. Otherwise, direct accesses to [MPAMSM_EL1](#) are UNDEFINED.

Attributes

[MPAMSM_EL1](#) is a 64-bit register.

Field descriptions

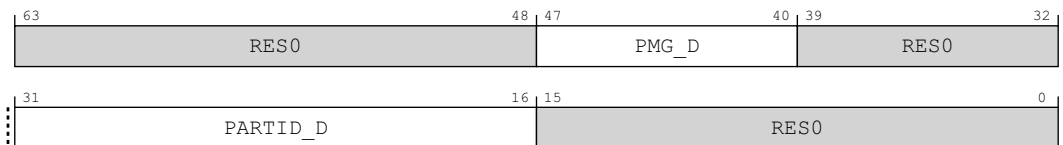

Bits [63:48]

Reserved, RES0.

PMG_D, bits [47:40]

Performance monitoring group property for [PARTID_D](#).

The reset behavior of this field is:

- On a Warm reset, this field resets to an architecturally UNKNOWN value.

Bits [39:32]

Reserved, RES0.

PARTID_D, bits [31:16]

Partition ID for requests issued due to the execution at any Exception level of SME load and store instructions and, when the PE is in Streaming SVE mode, SVE and SIMD&FP load and store instructions and SVE prefetch instructions.

The reset behavior of this field is:

- On a Warm reset, this field resets to an architecturally UNKNOWN value.

Bits [15:0]

Reserved, RES0.

Accessing MPAMSM_EL1

None of the fields in this register are permitted to be cached in a TLB.

Accesses to this register use the following encodings in the System register encoding space:

MRS <Xt>, MPAMSM_EL1

op0	op1	CRn	CRm	op2
0b11	0b000	0b1010	0b0101	0b011

```

if PSTATE.EL == EL0 then
    UNDEFINED;
elsif PSTATE.EL == EL1 then
    if HaveEL(EL3) && MPAM3_EL3.TRAPLOWER == '1' then
        if Haltd() && EDSCR.SDD == '1' then
            UNDEFINED;
        else
            AArch64.SystemAccessTrap(EL3, 0x18);
    elsif EL2Enabled() && MPAM2_EL2.EnMPAMSM == '0' then
        AArch64.SystemAccessTrap(EL2, 0x18);
    else
        X[t, 64] = MPAMSM_EL1;
elsif PSTATE.EL == EL2 then
    if HaveEL(EL3) && MPAM3_EL3.TRAPLOWER == '1' then
        if Haltd() && EDSCR.SDD == '1' then
            UNDEFINED;
        else
            AArch64.SystemAccessTrap(EL3, 0x18);
    else
        X[t, 64] = MPAMSM_EL1;
elsif PSTATE.EL == EL3 then
    X[t, 64] = MPAMSM_EL1;

```

MSR MPAMSM_EL1, <Xt>

op0	op1	CRn	CRm	op2
0b11	0b000	0b1010	0b0101	0b011

```

if PSTATE.EL == EL0 then
    UNDEFINED;
elsif PSTATE.EL == EL1 then
    if HaveEL(EL3) && MPAM3_EL3.TRAPLOWER == '1' then
        if Haltd() && EDSCR.SDD == '1' then
            UNDEFINED;
        else
            AArch64.SystemAccessTrap(EL3, 0x18);

```

```
    elsif EL2Enabled() && MPAM2_EL2.EnMPAMSM == '0' then
        AArch64.SystemAccessTrap(EL2, 0x18);
    else
        MPAMSM_EL1 = X[t, 64];
    elsif PSTATE.EL == EL2 then
        if HaveEL(EL3) && MPAM3_EL3.TRAPLOWER == '1' then
            if Halted() && EDSCR.SDD == '1' then
                UNDEFINED;
            else
                AArch64.SystemAccessTrap(EL3, 0x18);
            else
                MPAMSM_EL1 = X[t, 64];
    elsif PSTATE.EL == EL3 then
        MPAMSM_EL1 = X[t, 64];
```

7.4.8 MPAMVPM0_EL2, MPAM Virtual PARTID Mapping Register 0

The MPAMVPM0_EL2 characteristics are:

Purpose

MPAMVPM0_EL2 provides mappings from virtual PARTIDs 0 - 3 to physical PARTIDs. [MPAMIDR_EL1.VPMR_MAX](#) field gives the index of the highest implemented MPAMVPM<n>_EL2 register. VPMR_MAX can be as large as 7 (8 registers) or 32 virtual PARTIDs. If [MPAMIDR_EL1.VPMR_MAX](#) == 0, there is only a single MPAMVPM<n>_EL2 register, [MPAMVPM0_EL2](#).

Virtual PARTID mapping is enabled by [MPAMHCR_EL2.EL1_VPMEN](#) for PARTIDs in [MPAM1_EL1](#) and by [MPAMHCR_EL2.EL0_VPMEN](#) for PARTIDs in [MPAM0_EL1](#).

A virtual-to-physical PARTID mapping entry, PhyPARTID<n>, is valid only when the [MPAMVPMV_EL2.VPM_V](#) bit in bit position n is set to 1.

Configurations

This register is present only when FEAT_MPAM is implemented and [MPAMIDR_EL1.HAS_HCR](#) == 1. Otherwise, direct accesses to MPAMVPM0_EL2 are UNDEFINED.

This register has no effect if EL2 is not enabled in the current Security state.

Attributes

MPAMVPM0_EL2 is a 64-bit register.

Field descriptions

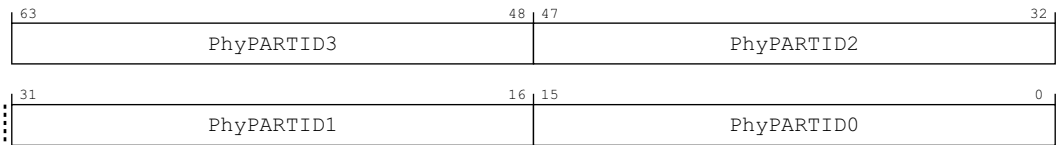

PhyPARTID3, bits [63:48]

Virtual PARTID Mapping Entry for virtual PARTID 3. PhyPARTID3 gives the mapping of virtual PARTID 3 to a physical PARTID.

The reset behavior of this field is:

- On a Warm reset, this field resets to an architecturally UNKNOWN value.

PhyPARTID2, bits [47:32]

Virtual PARTID Mapping Entry for virtual PARTID 2. PhyPARTID2 gives the mapping of virtual PARTID 2 to a physical PARTID.

The reset behavior of this field is:

- On a Warm reset, this field resets to an architecturally UNKNOWN value.

PhyPARTID1, bits [31:16]

Virtual PARTID Mapping Entry for virtual PARTID 1. PhyPARTID1 gives the mapping of virtual PARTID 1 to a physical PARTID.

The reset behavior of this field is:

- On a Warm reset, this field resets to an architecturally UNKNOWN value.

PhyPARTID0, bits [15:0]

Virtual PARTID Mapping Entry for virtual PARTID 0. PhyPARTID0 gives the mapping of virtual PARTID 0 to a physical PARTID.

The reset behavior of this field is:

- On a Warm reset, this field resets to an architecturally UNKNOWN value.

Accessing MPAMVPM0_EL2

Accesses to this register use the following encodings in the System register encoding space:

MRS <Xt>, MPAMVPM0_EL2

op0	op1	CRn	CRm	op2
0b11	0b100	0b1010	0b0110	0b000

```

if PSTATE.EL == EL0 then
    UNDEFINED;
elseif PSTATE.EL == EL1 then
    if EL2Enabled() && HCR_EL2.<NV2,NV> == '11' then
        X[t, 64] = NVMem[0x940];
    elseif EL2Enabled() && HCR_EL2.NV == '1' then
        if HaveEL(EL3) && MPAM3_EL3.TRAPLOWER == '1' then
            if Halted() && EDSCR.SDD == '1' then
                UNDEFINED;
            else
                AArch64.SystemAccessTrap(EL3, 0x18);
        else
            AArch64.SystemAccessTrap(EL2, 0x18);
    else
        UNDEFINED;
elseif PSTATE.EL == EL2 then
    if HaveEL(EL3) && MPAM3_EL3.TRAPLOWER == '1' then
        if Halted() && EDSCR.SDD == '1' then
            UNDEFINED;
        else
            AArch64.SystemAccessTrap(EL3, 0x18);
    else
        X[t, 64] = MPAMVPM0_EL2;
elseif PSTATE.EL == EL3 then
    X[t, 64] = MPAMVPM0_EL2;

```

MSR MPAMVPM0_EL2, <Xt>

op0	op1	CRn	CRm	op2
0b11	0b100	0b1010	0b0110	0b000

```

if PSTATE.EL == EL0 then
    UNDEFINED;
elseif PSTATE.EL == EL1 then
    if EL2Enabled() && HCR_EL2.<NV2,NV> == '11' then
        NVMem[0x940] = X[t, 64];
    elseif EL2Enabled() && HCR_EL2.NV == '1' then
        if HaveEL(EL3) && MPAM3_EL3.TRAPLOWER == '1' then
            if Halted() && EDSCR.SDD == '1' then
                UNDEFINED;
            else
                AArch64.SystemAccessTrap(EL3, 0x18);
        else
            AArch64.SystemAccessTrap(EL2, 0x18);
    else
        UNDEFINED;
elseif PSTATE.EL == EL2 then

```

```
if HaveEL(EL3) && MPAM3_EL3.TRAPLOWER == '1' then
    if Halted() && EDSCR.SDD == '1' then
        UNDEFINED;
    else
        AArch64.SystemAccessTrap(EL3, 0x18);
else
    MPAMVPM0_EL2 = X[t, 64];
elseif PSTATE.EL == EL3 then
    MPAMVPM0_EL2 = X[t, 64];
```

7.4.9 MPAMVPM1_EL2, MPAM Virtual PARTID Mapping Register 1

The MPAMVPM1_EL2 characteristics are:

Purpose

MPAMVPM1_EL2 provides mappings from virtual PARTIDs 4 - 7 to physical PARTIDs.

MPAMIDR_EL1.VPMR_MAX field gives the index of the highest implemented MPAMVPM0_EL2 to MPAMVPM7_EL2 registers. VPMR_MAX can be as large as 7 (8 registers) or 32 virtual PARTIDs. If MPAMIDR_EL1.VPMR_MAX == 0, there is only a single MPAMVPM<n>_EL2 register, MPAMVPM0_EL2.

Virtual PARTID mapping is enabled by MPAMHCR_EL2.EL1_VPMEN for PARTIDs in MPAM1_EL1 and by MPAMHCR_EL2.EL0_VPMEN for PARTIDs in MPAM0_EL1.

A virtual-to-physical PARTID mapping entry, PhyPARTID<n>, is valid only when the MPAMVPMV_EL2.VPM_V bit in bit position n is set to 1.

Configurations

This register is present only when FEAT_MPAM is implemented, MPAMIDR_EL1.HAS_HCR == 1 and UInt(MPAMIDR_EL1.VPMR_MAX) > 0. Otherwise, direct accesses to MPAMVPM1_EL2 are UNDEFINED.

This register has no effect if EL2 is not enabled in the current Security state.

Attributes

MPAMVPM1_EL2 is a 64-bit register.

Field descriptions

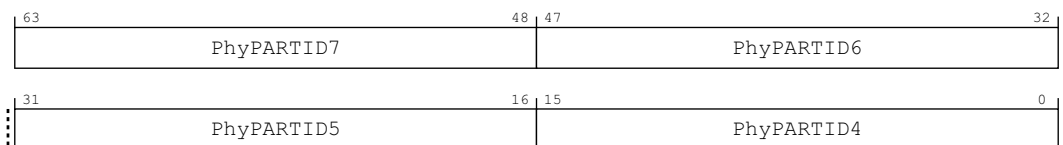

PhyPARTID7, bits [63:48]

Virtual PARTID Mapping Entry for virtual PARTID 7. PhyPARTID7 gives the mapping of virtual PARTID 7 to a physical PARTID.

The reset behavior of this field is:

- On a Warm reset, this field resets to an architecturally UNKNOWN value.

PhyPARTID6, bits [47:32]

Virtual PARTID Mapping Entry for virtual PARTID 6. PhyPARTID6 gives the mapping of virtual PARTID 6 to a physical PARTID.

The reset behavior of this field is:

- On a Warm reset, this field resets to an architecturally UNKNOWN value.

PhyPARTID5, bits [31:16]

Virtual PARTID Mapping Entry for virtual PARTID 5. PhyPARTID5 gives the mapping of virtual PARTID 5 to a physical PARTID.

The reset behavior of this field is:

- On a Warm reset, this field resets to an architecturally UNKNOWN value.

PhyPARTID4, bits [15:0]

Virtual PARTID Mapping Entry for virtual PARTID 4. PhyPARTID4 gives the mapping of virtual PARTID 4 to a physical PARTID.

The reset behavior of this field is:

- On a Warm reset, this field resets to an architecturally UNKNOWN value.

Accessing MPAMVPM1_EL2

Accesses to this register use the following encodings in the System register encoding space:

MRS <Xt>, MPAMVPM1_EL2

op0	op1	CRn	CRm	op2
0b11	0b100	0b1010	0b0110	0b001

```

if PSTATE.EL == EL0 then
    UNDEFINED;
elseif PSTATE.EL == EL1 then
    if EL2Enabled() && HCR_EL2.<NV2,NV> == '11' then
        X[t, 64] = NVMem[0x948];
    elseif EL2Enabled() && HCR_EL2.NV == '1' then
        if HaveEL(EL3) && MPAM3_EL3.TRAPLOWER == '1' then
            if Halted() && EDSCR.SDD == '1' then
                UNDEFINED;
            else
                AArch64.SystemAccessTrap(EL3, 0x18);
        else
            AArch64.SystemAccessTrap(EL2, 0x18);
    else
        UNDEFINED;
elseif PSTATE.EL == EL2 then
    if HaveEL(EL3) && MPAM3_EL3.TRAPLOWER == '1' then
        if Halted() && EDSCR.SDD == '1' then
            UNDEFINED;
        else
            AArch64.SystemAccessTrap(EL3, 0x18);
    else
        X[t, 64] = MPAMVPM1_EL2;
elseif PSTATE.EL == EL3 then
    X[t, 64] = MPAMVPM1_EL2;

```

MSR MPAMVPM1_EL2, <Xt>

op0	op1	CRn	CRm	op2
0b11	0b100	0b1010	0b0110	0b001

```

if PSTATE.EL == EL0 then
    UNDEFINED;
elseif PSTATE.EL == EL1 then
    if EL2Enabled() && HCR_EL2.<NV2,NV> == '11' then
        NVMem[0x948] = X[t, 64];
    elseif EL2Enabled() && HCR_EL2.NV == '1' then
        if HaveEL(EL3) && MPAM3_EL3.TRAPLOWER == '1' then
            if Halted() && EDSCR.SDD == '1' then
                UNDEFINED;
            else
                AArch64.SystemAccessTrap(EL3, 0x18);
        else
            AArch64.SystemAccessTrap(EL2, 0x18);
    else
        UNDEFINED;
elseif PSTATE.EL == EL2 then

```

```
if HaveEL(EL3) && MPAM3_EL3.TRAPLOWER == '1' then
    if Halted() && EDSCR.SDD == '1' then
        UNDEFINED;
    else
        AArch64.SystemAccessTrap(EL3, 0x18);
    else
        MPAMVPM1_EL2 = X[t, 64];
elseif PSTATE.EL == EL3 then
    MPAMVPM1_EL2 = X[t, 64];
```

7.4.10 MPAMVPM2_EL2, MPAM Virtual PARTID Mapping Register 2

The MPAMVPM2_EL2 characteristics are:

Purpose

MPAMVPM2_EL2 provides mappings from virtual PARTIDs 8 - 11 to physical PARTIDs.

MPAMIDR_EL1.VPMR_MAX field gives the index of the highest implemented MPAMVPM0_EL2 to MPAMVPM7_EL2 registers. VPMR_MAX can be as large as 7 (8 registers) or 32 virtual PARTIDs. If MPAMIDR_EL1.VPMR_MAX == 0, there is only a single MPAMVPM<n>_EL2 register, MPAMVPM0_EL2.

Virtual PARTID mapping is enabled by MPAMHCR_EL2.EL1_VPMEN for PARTIDs in MPAM1_EL1 and by MPAMHCR_EL2.EL0_VPMEN for PARTIDs in MPAM0_EL1.

A virtual-to-physical PARTID mapping entry, PhyPARTID<n>, is valid only when the MPAMVPMV_EL2.VPM_V bit in bit position n is set to 1.

Configurations

This register is present only when FEAT_MPAM is implemented, MPAMIDR_EL1.HAS_HCR == 1 and UInt(MPAMIDR_EL1.VPMR_MAX) > 1. Otherwise, direct accesses to MPAMVPM2_EL2 are UNDEFINED.

This register has no effect if EL2 is not enabled in the current Security state.

Attributes

MPAMVPM2_EL2 is a 64-bit register.

Field descriptions

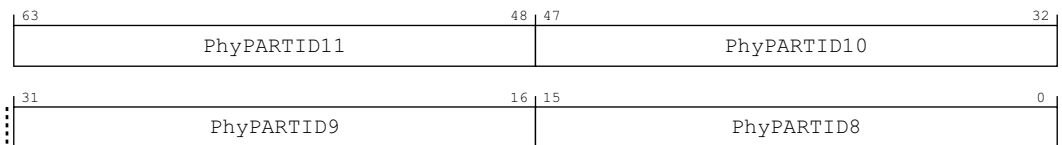

PhyPARTID11, bits [63:48]

Virtual PARTID Mapping Entry for virtual PARTID 11. PhyPARTID11 gives the mapping of virtual PARTID 11 to a physical PARTID.

The reset behavior of this field is:

- On a Warm reset, this field resets to an architecturally UNKNOWN value.

PhyPARTID10, bits [47:32]

Virtual PARTID Mapping Entry for virtual PARTID 10. PhyPARTID10 gives the mapping of virtual PARTID 10 to a physical PARTID.

The reset behavior of this field is:

- On a Warm reset, this field resets to an architecturally UNKNOWN value.

PhyPARTID9, bits [31:16]

Virtual PARTID Mapping Entry for virtual PARTID 9. PhyPARTID9 gives the mapping of virtual PARTID 9 to a physical PARTID.

The reset behavior of this field is:

- On a Warm reset, this field resets to an architecturally UNKNOWN value.

PhyPARTID8, bits [15:0]

Virtual PARTID Mapping Entry for virtual PARTID 8. PhyPARTID8 gives the mapping of virtual PARTID 8 to a physical PARTID.

The reset behavior of this field is:

- On a Warm reset, this field resets to an architecturally UNKNOWN value.

Accessing MPAMVPM2_EL2

Accesses to this register use the following encodings in the System register encoding space:

MRS <Xt>, MPAMVPM2_EL2

op0	op1	CRn	CRm	op2
0b11	0b100	0b1010	0b0110	0b010

```

if PSTATE.EL == EL0 then
    UNDEFINED;
elseif PSTATE.EL == EL1 then
    if EL2Enabled() && HCR_EL2.<NV2,NV> == '11' then
        X[t, 64] = NVMem[0x950];
    elseif EL2Enabled() && HCR_EL2.NV == '1' then
        if HaveEL(EL3) && MPAM3_EL3.TRAPLOWER == '1' then
            if Halted() && EDSCR.SDD == '1' then
                UNDEFINED;
            else
                AArch64.SystemAccessTrap(EL3, 0x18);
        else
            AArch64.SystemAccessTrap(EL2, 0x18);
    else
        UNDEFINED;
elseif PSTATE.EL == EL2 then
    if HaveEL(EL3) && MPAM3_EL3.TRAPLOWER == '1' then
        if Halted() && EDSCR.SDD == '1' then
            UNDEFINED;
        else
            AArch64.SystemAccessTrap(EL3, 0x18);
    else
        X[t, 64] = MPAMVPM2_EL2;
elseif PSTATE.EL == EL3 then
    X[t, 64] = MPAMVPM2_EL2;

```

MSR MPAMVPM2_EL2, <Xt>

op0	op1	CRn	CRm	op2
0b11	0b100	0b1010	0b0110	0b010

```

if PSTATE.EL == EL0 then
    UNDEFINED;
elseif PSTATE.EL == EL1 then
    if EL2Enabled() && HCR_EL2.<NV2,NV> == '11' then
        NVMem[0x950] = X[t, 64];
    elseif EL2Enabled() && HCR_EL2.NV == '1' then
        if HaveEL(EL3) && MPAM3_EL3.TRAPLOWER == '1' then
            if Halted() && EDSCR.SDD == '1' then
                UNDEFINED;
            else
                AArch64.SystemAccessTrap(EL3, 0x18);
        else
            AArch64.SystemAccessTrap(EL2, 0x18);
    else
        UNDEFINED;
elseif PSTATE.EL == EL2 then

```

```
if HaveEL(EL3) && MPAM3_EL3.TRAPLOWER == '1' then
    if Halted() && EDSCR.SDD == '1' then
        UNDEFINED;
    else
        AArch64.SystemAccessTrap(EL3, 0x18);
else
    MPAMVPM2_EL2 = X[t, 64];
elseif PSTATE.EL == EL3 then
    MPAMVPM2_EL2 = X[t, 64];
```

7.4.11 MPAMVPM3_EL2, MPAM Virtual PARTID Mapping Register 3

The MPAMVPM3_EL2 characteristics are:

Purpose

MPAMVPM3_EL2 provides mappings from virtual PARTIDs 12 - 15 to physical PARTIDs.

[MPAMIDR_EL1.VPMR_MAX](#) gives the index of the highest implemented MPAMVPM<n>_EL2 registers. VPMR_MAX can be as large as 7 (8 registers) or 32 virtual PARTIDs. If [MPAMIDR_EL1.VPMR_MAX](#) == 0, there is only a single MPAMVPM<n>_EL2 register, [MPAMVPM0_EL2](#).

Virtual PARTID mapping is enabled by [MPAMHCR_EL2.EL1_VPMEN](#) for PARTIDs in [MPAM1_EL1](#) and by [MPAMHCR_EL2.EL0_VPMEN](#) for PARTIDs in [MPAM0_EL1](#).

A virtual-to-physical PARTID mapping entry, PhyPARTID<n>, is valid only when the [MPAMVPMV_EL2.VPM_V](#) bit in bit position n is set to 1.

Configurations

This register is present only when FEAT_MPAM is implemented, [MPAMIDR_EL1.HAS_HCR](#) == 1 and $\text{UInt}(\text{MPAMIDR_EL1.VPMR_MAX}) > 2$. Otherwise, direct accesses to MPAMVPM3_EL2 are UNDEFINED.

This register has no effect if EL2 is not enabled in the current Security state.

Attributes

MPAMVPM3_EL2 is a 64-bit register.

Field descriptions

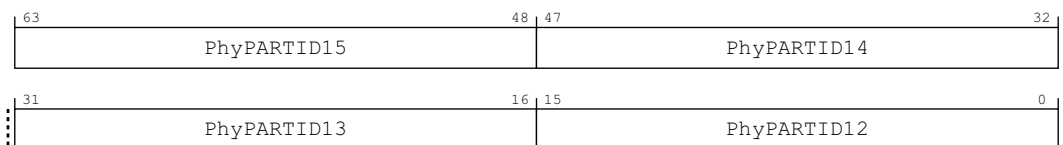

PhyPARTID15, bits [63:48]

Virtual PARTID Mapping Entry for virtual PARTID 15. PhyPARTID15 gives the mapping of virtual PARTID 15 to a physical PARTID.

The reset behavior of this field is:

- On a Warm reset, this field resets to an architecturally UNKNOWN value.

PhyPARTID14, bits [47:32]

Virtual PARTID Mapping Entry for virtual PARTID 14. PhyPARTID14 gives the mapping of virtual PARTID 14 to a physical PARTID.

The reset behavior of this field is:

- On a Warm reset, this field resets to an architecturally UNKNOWN value.

PhyPARTID13, bits [31:16]

Virtual PARTID Mapping Entry for virtual PARTID 13. PhyPARTID13 gives the mapping of virtual PARTID 13 to a physical PARTID.

The reset behavior of this field is:

- On a Warm reset, this field resets to an architecturally UNKNOWN value.

PhyPARTID12, bits [15:0]

Virtual PARTID Mapping Entry for virtual PARTID 12. PhyPARTID12 gives the mapping of virtual PARTID 12 to a physical PARTID.

The reset behavior of this field is:

- On a Warm reset, this field resets to an architecturally UNKNOWN value.

Accessing MPAMVPM3_EL2

Accesses to this register use the following encodings in the System register encoding space:

MRS <Xt>, MPAMVPM3_EL2

op0	op1	CRn	CRm	op2
0b11	0b100	0b1010	0b0110	0b011

```

if PSTATE.EL == EL0 then
    UNDEFINED;
elseif PSTATE.EL == EL1 then
    if EL2Enabled() && HCR_EL2.<NV2,NV> == '11' then
        X[t, 64] = NVMem[0x958];
    elseif EL2Enabled() && HCR_EL2.NV == '1' then
        if HaveEL(EL3) && MPAM3_EL3.TRAPLOWER == '1' then
            if Halted() && EDSCR.SDD == '1' then
                UNDEFINED;
            else
                AArch64.SystemAccessTrap(EL3, 0x18);
        else
            AArch64.SystemAccessTrap(EL2, 0x18);
    else
        UNDEFINED;
elseif PSTATE.EL == EL2 then
    if HaveEL(EL3) && MPAM3_EL3.TRAPLOWER == '1' then
        if Halted() && EDSCR.SDD == '1' then
            UNDEFINED;
        else
            AArch64.SystemAccessTrap(EL3, 0x18);
    else
        X[t, 64] = MPAMVPM3_EL2;
elseif PSTATE.EL == EL3 then
    X[t, 64] = MPAMVPM3_EL2;

```

MSR MPAMVPM3_EL2, <Xt>

op0	op1	CRn	CRm	op2
0b11	0b100	0b1010	0b0110	0b011

```

if PSTATE.EL == EL0 then
    UNDEFINED;
elseif PSTATE.EL == EL1 then
    if EL2Enabled() && HCR_EL2.<NV2,NV> == '11' then
        NVMem[0x958] = X[t, 64];
    elseif EL2Enabled() && HCR_EL2.NV == '1' then
        if HaveEL(EL3) && MPAM3_EL3.TRAPLOWER == '1' then
            if Halted() && EDSCR.SDD == '1' then
                UNDEFINED;
            else
                AArch64.SystemAccessTrap(EL3, 0x18);
        else
            AArch64.SystemAccessTrap(EL2, 0x18);
    else
        UNDEFINED;
elseif PSTATE.EL == EL2 then

```

```
if HaveEL(EL3) && MPAM3_EL3.TRAPLOWER == '1' then
    if Halted() && EDSCR.SDD == '1' then
        UNDEFINED;
    else
        AArch64.SystemAccessTrap(EL3, 0x18);
    else
        MPAMVPM3_EL2 = X[t, 64];
elseif PSTATE.EL == EL3 then
    MPAMVPM3_EL2 = X[t, 64];
```

7.4.12 MPAMVPM4_EL2, MPAM Virtual PARTID Mapping Register 4

The MPAMVPM4_EL2 characteristics are:

Purpose

MPAMVPM4_EL2 provides mappings from virtual PARTIDs 16 - 19 to physical PARTIDs. [MPAMIDR_EL1.VPMR_MAX](#) gives the index of the highest implemented MPAMVPM<n>_EL2 registers. VPMR_MAX can be as large as 7 (8 registers) or 32 virtual PARTIDs. If [MPAMIDR_EL1.VPMR_MAX](#) == 0, there is only a single MPAMVPM<n>_EL2 register, [MPAMVPM0_EL2](#).

Virtual PARTID mapping is enabled by [MPAMHCR_EL2.EL1_VPMEN](#) for PARTIDs in [MPAM1_EL1](#) and by [MPAMHCR_EL2.EL0_VPMEN](#) for PARTIDs in [MPAM0_EL1](#).

A virtual-to-physical PARTID mapping entry, PhyPARTID<n>, is valid only when the [MPAMVPMV_EL2.VPM_V](#) bit in bit position n is set to 1.

Configurations

This register is present only when FEAT_MPAM is implemented, [MPAMIDR_EL1.HAS_HCR](#) == 1 and $\text{UInt}(\text{MPAMIDR_EL1.VPMR_MAX}) > 3$. Otherwise, direct accesses to MPAMVPM4_EL2 are UNDEFINED.

This register has no effect if EL2 is not enabled in the current Security state.

Attributes

MPAMVPM4_EL2 is a 64-bit register.

Field descriptions

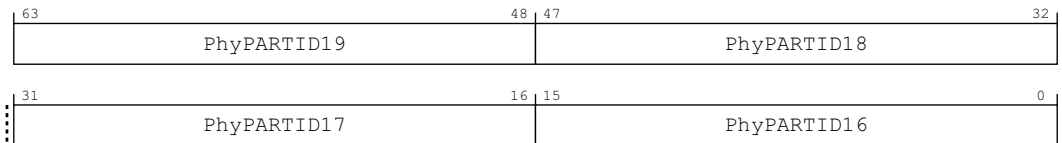

PhyPARTID19, bits [63:48]

Virtual PARTID Mapping Entry for virtual PARTID 19. PhyPARTID19 gives the mapping of virtual PARTID 19 to a physical PARTID.

The reset behavior of this field is:

- On a Warm reset, this field resets to an architecturally UNKNOWN value.

PhyPARTID18, bits [47:32]

Virtual PARTID Mapping Entry for virtual PARTID 18. PhyPARTID18 gives the mapping of virtual PARTID 18 to a physical PARTID.

The reset behavior of this field is:

- On a Warm reset, this field resets to an architecturally UNKNOWN value.

PhyPARTID17, bits [31:16]

Virtual PARTID Mapping Entry for virtual PARTID 17. PhyPARTID17 gives the mapping of virtual PARTID 17 to a physical PARTID.

The reset behavior of this field is:

- On a Warm reset, this field resets to an architecturally UNKNOWN value.

PhyPARTID16, bits [15:0]

Virtual PARTID Mapping Entry for virtual PARTID 16. PhyPARTID16 gives the mapping of virtual PARTID 16 to a physical PARTID.

The reset behavior of this field is:

- On a Warm reset, this field resets to an architecturally UNKNOWN value.

Accessing MPAMVPM4_EL2

Accesses to this register use the following encodings in the System register encoding space:

MRS <Xt>, MPAMVPM4_EL2

op0	op1	CRn	CRm	op2
0b11	0b100	0b1010	0b0110	0b100

```

if PSTATE.EL == EL0 then
    UNDEFINED;
elseif PSTATE.EL == EL1 then
    if EL2Enabled() && HCR_EL2.<NV2,NV> == '11' then
        X[t, 64] = NVMem[0x960];
    elseif EL2Enabled() && HCR_EL2.NV == '1' then
        if HaveEL(EL3) && MPAM3_EL3.TRAPLOWER == '1' then
            if Halted() && EDSCR.SDD == '1' then
                UNDEFINED;
            else
                AArch64.SystemAccessTrap(EL3, 0x18);
        else
            AArch64.SystemAccessTrap(EL2, 0x18);
    else
        UNDEFINED;
elseif PSTATE.EL == EL2 then
    if HaveEL(EL3) && MPAM3_EL3.TRAPLOWER == '1' then
        if Halted() && EDSCR.SDD == '1' then
            UNDEFINED;
        else
            AArch64.SystemAccessTrap(EL3, 0x18);
    else
        X[t, 64] = MPAMVPM4_EL2;
elseif PSTATE.EL == EL3 then
    X[t, 64] = MPAMVPM4_EL2;

```

MSR MPAMVPM4_EL2, <Xt>

op0	op1	CRn	CRm	op2
0b11	0b100	0b1010	0b0110	0b100

```

if PSTATE.EL == EL0 then
    UNDEFINED;
elseif PSTATE.EL == EL1 then
    if EL2Enabled() && HCR_EL2.<NV2,NV> == '11' then
        NVMem[0x960] = X[t, 64];
    elseif EL2Enabled() && HCR_EL2.NV == '1' then
        if HaveEL(EL3) && MPAM3_EL3.TRAPLOWER == '1' then
            if Halted() && EDSCR.SDD == '1' then
                UNDEFINED;
            else
                AArch64.SystemAccessTrap(EL3, 0x18);
        else
            AArch64.SystemAccessTrap(EL2, 0x18);
    else
        UNDEFINED;
elseif PSTATE.EL == EL2 then

```

```
if HaveEL(EL3) && MPAM3_EL3.TRAPLOWER == '1' then
    if Halted() && EDSCR.SDD == '1' then
        UNDEFINED;
    else
        AArch64.SystemAccessTrap(EL3, 0x18);
else
    MPAMVPM4_EL2 = X[t, 64];
elseif PSTATE.EL == EL3 then
    MPAMVPM4_EL2 = X[t, 64];
```

7.4.13 MPAMVPM5_EL2, MPAM Virtual PARTID Mapping Register 5

The MPAMVPM5_EL2 characteristics are:

Purpose

MPAMVPM5_EL2 provides mappings from virtual PARTIDs 20 - 23 to physical PARTIDs.

[MPAMIDR_EL1.VPMR_MAX](#) gives the index of the highest implemented MPAMVPM<n>_EL2 registers. VPMR_MAX can be as large as 7 (8 registers) or 32 virtual PARTIDs. If [MPAMIDR_EL1.VPMR_MAX](#) == 0, there is only a single MPAMVPM<n>_EL2 register, [MPAMVPM0_EL2](#).

Virtual PARTID mapping is enabled by [MPAMHCR_EL2.EL1_VPMEN](#) for PARTIDs in [MPAM1_EL1](#) and by [MPAMHCR_EL2.EL0_VPMEN](#) for PARTIDs in [MPAM0_EL1](#).

A virtual-to-physical PARTID mapping entry, PhyPARTID<n>, is valid only when the [MPAMVPMV_EL2.VPM_V](#) bit in bit position n is set to 1.

Configurations

This register is present only when FEAT_MPAM is implemented, [MPAMIDR_EL1.HAS_HCR](#) == 1 and $\text{UInt}(\text{MPAMIDR_EL1.VPMR_MAX}) > 4$. Otherwise, direct accesses to MPAMVPM5_EL2 are UNDEFINED.

This register has no effect if EL2 is not enabled in the current Security state.

Attributes

MPAMVPM5_EL2 is a 64-bit register.

Field descriptions

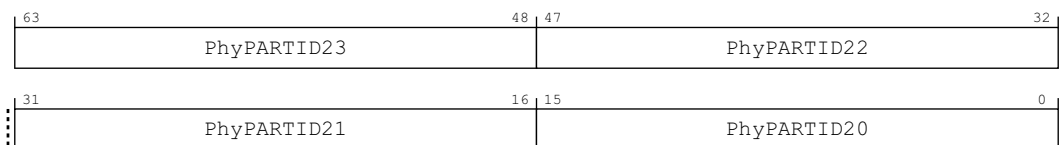

PhyPARTID23, bits [63:48]

Virtual PARTID Mapping Entry for virtual PARTID 23. PhyPARTID23 gives the mapping of virtual PARTID 23 to a physical PARTID.

The reset behavior of this field is:

- On a Warm reset, this field resets to an architecturally UNKNOWN value.

PhyPARTID22, bits [47:32]

Virtual PARTID Mapping Entry for virtual PARTID 22. PhyPARTID22 gives the mapping of virtual PARTID 22 to a physical PARTID.

The reset behavior of this field is:

- On a Warm reset, this field resets to an architecturally UNKNOWN value.

PhyPARTID21, bits [31:16]

Virtual PARTID Mapping Entry for virtual PARTID 21. PhyPARTID21 gives the mapping of virtual PARTID 21 to a physical PARTID.

The reset behavior of this field is:

- On a Warm reset, this field resets to an architecturally UNKNOWN value.

PhyPARTID20, bits [15:0]

Virtual PARTID Mapping Entry for virtual PARTID 20. PhyPARTID20 gives the mapping of virtual PARTID 20 to a physical PARTID.

The reset behavior of this field is:

- On a Warm reset, this field resets to an architecturally UNKNOWN value.

Accessing MPAMVPM5_EL2

Accesses to this register use the following encodings in the System register encoding space:

MRS <Xt>, MPAMVPM5_EL2

op0	op1	CRn	CRm	op2
0b11	0b100	0b1010	0b0110	0b101

```

if PSTATE.EL == EL0 then
    UNDEFINED;
elseif PSTATE.EL == EL1 then
    if EL2Enabled() && HCR_EL2.<NV2,NV> == '11' then
        X[t, 64] = NVMem[0x968];
    elseif EL2Enabled() && HCR_EL2.NV == '1' then
        if HaveEL(EL3) && MPAM3_EL3.TRAPLOWER == '1' then
            if Halted() && EDSCR.SDD == '1' then
                UNDEFINED;
            else
                AArch64.SystemAccessTrap(EL3, 0x18);
        else
            AArch64.SystemAccessTrap(EL2, 0x18);
    else
        UNDEFINED;
elseif PSTATE.EL == EL2 then
    if HaveEL(EL3) && MPAM3_EL3.TRAPLOWER == '1' then
        if Halted() && EDSCR.SDD == '1' then
            UNDEFINED;
        else
            AArch64.SystemAccessTrap(EL3, 0x18);
    else
        X[t, 64] = MPAMVPM5_EL2;
elseif PSTATE.EL == EL3 then
    X[t, 64] = MPAMVPM5_EL2;

```

MSR MPAMVPM5_EL2, <Xt>

op0	op1	CRn	CRm	op2
0b11	0b100	0b1010	0b0110	0b101

```

if PSTATE.EL == EL0 then
    UNDEFINED;
elseif PSTATE.EL == EL1 then
    if EL2Enabled() && HCR_EL2.<NV2,NV> == '11' then
        NVMem[0x968] = X[t, 64];
    elseif EL2Enabled() && HCR_EL2.NV == '1' then
        if HaveEL(EL3) && MPAM3_EL3.TRAPLOWER == '1' then
            if Halted() && EDSCR.SDD == '1' then
                UNDEFINED;
            else
                AArch64.SystemAccessTrap(EL3, 0x18);
        else
            AArch64.SystemAccessTrap(EL2, 0x18);
    else
        UNDEFINED;
elseif PSTATE.EL == EL2 then

```



```
if HaveEL(EL3) && MPAM3_EL3.TRAPLOWER == '1' then
    if Halted() && EDSCR.SDD == '1' then
        UNDEFINED;
    else
        AArch64.SystemAccessTrap(EL3, 0x18);
    else
        MPAMVPM5_EL2 = X[t, 64];
elseif PSTATE.EL == EL3 then
    MPAMVPM5_EL2 = X[t, 64];
```

7.4.14 MPAMVPM6_EL2, MPAM Virtual PARTID Mapping Register 6

The MPAMVPM6_EL2 characteristics are:

Purpose

MPAMVPM6_EL2 provides mappings from virtual PARTIDs 24 - 27 to physical PARTIDs. [MPAMIDR_EL1.VPMR_MAX](#) gives the index of the highest implemented MPAMVPM<n>_EL2 registers. VPMR_MAX can be as large as 7 (8 registers) or 32 virtual PARTIDs. If [MPAMIDR_EL1.VPMR_MAX](#) == 0, there is only a single MPAMVPM<n>_EL2 register, [MPAMVPM0_EL2](#).

Virtual PARTID mapping is enabled by [MPAMHCR_EL2.EL1_VPMEN](#) for PARTIDs in [MPAM1_EL1](#) and by [MPAMHCR_EL2.EL0_VPMEN](#) for PARTIDs in [MPAM0_EL1](#).

A virtual-to-physical PARTID mapping entry, PhyPARTID<n>, is valid only when the [MPAMVPMV_EL2.VPM_V](#) bit in bit position n is set to 1.

Configurations

This register is present only when FEAT_MPAM is implemented, [MPAMIDR_EL1.HAS_HCR](#) == 1 and $\text{UInt}(\text{MPAMIDR_EL1.VPMR_MAX}) > 5$. Otherwise, direct accesses to MPAMVPM6_EL2 are UNDEFINED.

This register has no effect if EL2 is not enabled in the current Security state.

Attributes

MPAMVPM6_EL2 is a 64-bit register.

Field descriptions

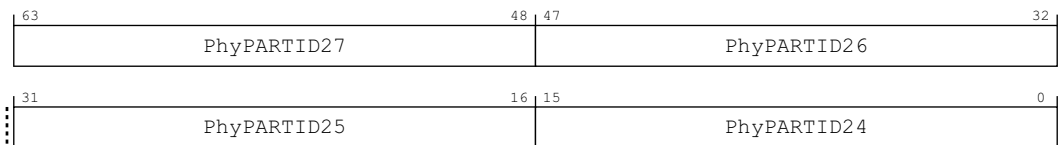

PhyPARTID27, bits [63:48]

Virtual PARTID Mapping Entry for virtual PARTID 27. PhyPARTID27 gives the mapping of virtual PARTID 27 to a physical PARTID.

The reset behavior of this field is:

- On a Warm reset, this field resets to an architecturally UNKNOWN value.

PhyPARTID26, bits [47:32]

Virtual PARTID Mapping Entry for virtual PARTID 26. PhyPARTID26 gives the mapping of virtual PARTID 26 to a physical PARTID.

The reset behavior of this field is:

- On a Warm reset, this field resets to an architecturally UNKNOWN value.

PhyPARTID25, bits [31:16]

Virtual PARTID Mapping Entry for virtual PARTID 25. PhyPARTID25 gives the mapping of virtual PARTID 25 to a physical PARTID.

The reset behavior of this field is:

- On a Warm reset, this field resets to an architecturally UNKNOWN value.

PhyPARTID24, bits [15:0]

Virtual PARTID Mapping Entry for virtual PARTID 24. PhyPARTID24 gives the mapping of virtual PARTID 24 to a physical PARTID.

The reset behavior of this field is:

- On a Warm reset, this field resets to an architecturally UNKNOWN value.

Accessing MPAMVPM6_EL2

Accesses to this register use the following encodings in the System register encoding space:

MRS <Xt>, MPAMVPM6_EL2

op0	op1	CRn	CRm	op2
0b11	0b100	0b1010	0b0110	0b110

```

if PSTATE.EL == EL0 then
    UNDEFINED;
elseif PSTATE.EL == EL1 then
    if EL2Enabled() && HCR_EL2.<NV2,NV> == '11' then
        X[t, 64] = NVMem[0x970];
    elseif EL2Enabled() && HCR_EL2.NV == '1' then
        if HaveEL(EL3) && MPAM3_EL3.TRAPLOWER == '1' then
            if Halted() && EDSCR.SDD == '1' then
                UNDEFINED;
            else
                AArch64.SystemAccessTrap(EL3, 0x18);
        else
            AArch64.SystemAccessTrap(EL2, 0x18);
    else
        UNDEFINED;
elseif PSTATE.EL == EL2 then
    if HaveEL(EL3) && MPAM3_EL3.TRAPLOWER == '1' then
        if Halted() && EDSCR.SDD == '1' then
            UNDEFINED;
        else
            AArch64.SystemAccessTrap(EL3, 0x18);
    else
        X[t, 64] = MPAMVPM6_EL2;
elseif PSTATE.EL == EL3 then
    X[t, 64] = MPAMVPM6_EL2;

```

MSR MPAMVPM6_EL2, <Xt>

op0	op1	CRn	CRm	op2
0b11	0b100	0b1010	0b0110	0b110

```

if PSTATE.EL == EL0 then
    UNDEFINED;
elseif PSTATE.EL == EL1 then
    if EL2Enabled() && HCR_EL2.<NV2,NV> == '11' then
        NVMem[0x970] = X[t, 64];
    elseif EL2Enabled() && HCR_EL2.NV == '1' then
        if HaveEL(EL3) && MPAM3_EL3.TRAPLOWER == '1' then
            if Halted() && EDSCR.SDD == '1' then
                UNDEFINED;
            else
                AArch64.SystemAccessTrap(EL3, 0x18);
        else
            AArch64.SystemAccessTrap(EL2, 0x18);
    else
        UNDEFINED;
elseif PSTATE.EL == EL2 then

```

```
if HaveEL(EL3) && MPAM3_EL3.TRAPLOWER == '1' then
    if Halted() && EDSCR.SDD == '1' then
        UNDEFINED;
    else
        AArch64.SystemAccessTrap(EL3, 0x18);
else
    MPAMVPM6_EL2 = X[t, 64];
elseif PSTATE.EL == EL3 then
    MPAMVPM6_EL2 = X[t, 64];
```

7.4.15 MPAMVPM7_EL2, MPAM Virtual PARTID Mapping Register 7

The MPAMVPM7_EL2 characteristics are:

Purpose

MPAMVPM7_EL2 provides mappings from virtual PARTIDs 28 - 31 to physical PARTIDs.

[MPAMIDR_EL1.VPMR_MAX](#) gives the index of the highest implemented MPAMVPM<n>_EL2 registers. VPMR_MAX can be as large as 7 (8 registers) or 32 virtual PARTIDs. If [MPAMIDR_EL1.VPMR_MAX](#) == 0, there is only a single MPAMVPM<n>_EL2 register, [MPAMVPM0_EL2](#).

Virtual PARTID mapping is enabled by [MPAMHCR_EL2.EL1_VPMEN](#) for PARTIDs in [MPAM1_EL1](#) and by [MPAMHCR_EL2.EL0_VPMEN](#) for [MPAM0_EL1](#).

A virtual-to-physical PARTID mapping entry, PhyPARTID<n>, is valid only when the [MPAMVPMV_EL2.VPM_V](#) bit in bit position n is set to 1.

Configurations

This register is present only when FEAT_MPAM is implemented, [MPAMIDR_EL1.HAS_HCR](#) == 1 and [MPAMIDR_EL1.VPMR_MAX](#) == 7. Otherwise, direct accesses to MPAMVPM7_EL2 are UNDEFINED.

This register has no effect if EL2 is not enabled in the current Security state.

Attributes

MPAMVPM7_EL2 is a 64-bit register.

Field descriptions

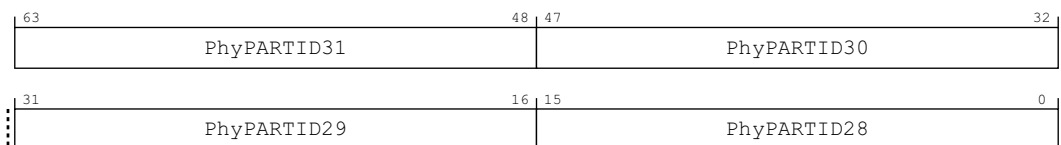

PhyPARTID31, bits [63:48]

Virtual PARTID Mapping Entry for virtual PARTID 31. PhyPARTID31 gives the mapping of virtual PARTID 31 to a physical PARTID.

The reset behavior of this field is:

- On a Warm reset, this field resets to an architecturally UNKNOWN value.

PhyPARTID30, bits [47:32]

Virtual PARTID Mapping Entry for virtual PARTID 30. PhyPARTID30 gives the mapping of virtual PARTID 30 to a physical PARTID.

The reset behavior of this field is:

- On a Warm reset, this field resets to an architecturally UNKNOWN value.

PhyPARTID29, bits [31:16]

Virtual PARTID Mapping Entry for virtual PARTID 29. PhyPARTID29 gives the mapping of virtual PARTID 29 to a physical PARTID.

The reset behavior of this field is:

- On a Warm reset, this field resets to an architecturally UNKNOWN value.

PhyPARTID28, bits [15:0]

Virtual PARTID Mapping Entry for virtual PARTID 28. PhyPARTID28 gives the mapping of virtual PARTID 28 to a physical PARTID.

The reset behavior of this field is:

- On a Warm reset, this field resets to an architecturally UNKNOWN value.

Accessing MPAMVPM7_EL2

Accesses to this register use the following encodings in the System register encoding space:

MRS <Xt>, MPAMVPM7_EL2

op0	op1	CRn	CRm	op2
0b11	0b100	0b1010	0b0110	0b111

```

if PSTATE.EL == EL0 then
    UNDEFINED;
elseif PSTATE.EL == EL1 then
    if EL2Enabled() && HCR_EL2.<NV2,NV> == '11' then
        X[t, 64] = NVMem[0x978];
    elseif EL2Enabled() && HCR_EL2.NV == '1' then
        if HaveEL(EL3) && MPAM3_EL3.TRAPLOWER == '1' then
            if Halted() && EDSCR.SDD == '1' then
                UNDEFINED;
            else
                AArch64.SystemAccessTrap(EL3, 0x18);
        else
            AArch64.SystemAccessTrap(EL2, 0x18);
    else
        UNDEFINED;
elseif PSTATE.EL == EL2 then
    if HaveEL(EL3) && MPAM3_EL3.TRAPLOWER == '1' then
        if Halted() && EDSCR.SDD == '1' then
            UNDEFINED;
        else
            AArch64.SystemAccessTrap(EL3, 0x18);
    else
        X[t, 64] = MPAMVPM7_EL2;
elseif PSTATE.EL == EL3 then
    X[t, 64] = MPAMVPM7_EL2;

```

MSR MPAMVPM7_EL2, <Xt>

op0	op1	CRn	CRm	op2
0b11	0b100	0b1010	0b0110	0b111

```

if PSTATE.EL == EL0 then
    UNDEFINED;
elseif PSTATE.EL == EL1 then
    if EL2Enabled() && HCR_EL2.<NV2,NV> == '11' then
        NVMem[0x978] = X[t, 64];
    elseif EL2Enabled() && HCR_EL2.NV == '1' then
        if HaveEL(EL3) && MPAM3_EL3.TRAPLOWER == '1' then
            if Halted() && EDSCR.SDD == '1' then
                UNDEFINED;
            else
                AArch64.SystemAccessTrap(EL3, 0x18);
        else
            AArch64.SystemAccessTrap(EL2, 0x18);
    else
        UNDEFINED;
elseif PSTATE.EL == EL2 then

```

```
if HaveEL(EL3) && MPAM3_EL3.TRAPLOWER == '1' then
    if Halted() && EDSCR.SDD == '1' then
        UNDEFINED;
    else
        AArch64.SystemAccessTrap(EL3, 0x18);
    else
        MPAMVPM7_EL2 = X[t, 64];
elseif PSTATE.EL == EL3 then
    MPAMVPM7_EL2 = X[t, 64];
```

7.4.16 MPAMVPMV_EL2, MPAM Virtual Partition Mapping Valid Register

The MPAMVPMV_EL2 characteristics are:

Purpose

Valid bits for virtual PARTID mapping entries. Each bit *m* corresponds to virtual PARTID mapping entry *m* in the MPAMVPMV<*n*>_EL2 registers where $n = m \gg 2$.

Configurations

This register is present only when FEAT_MPAM is implemented and MPAMIDR_EL1.HAS_HCR == 1. Otherwise, direct accesses to MPAMVPMV_EL2 are UNDEFINED.

This register has no effect if EL2 is not enabled in the current Security state.

Attributes

MPAMVPMV_EL2 is a 64-bit register.

Field descriptions

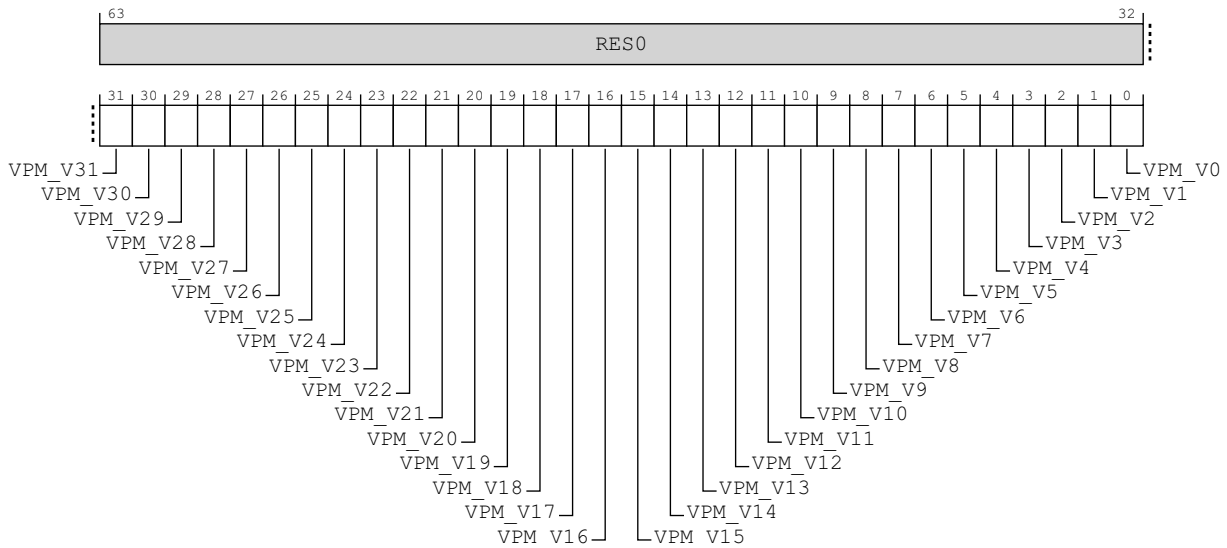

Bits [63:32]

Reserved, RES0.

VPM_V<*m*>, bit [*m*], for *m* = 31 to 0

Contains valid bit for virtual PARTID mapping entry corresponding to virtual PARTID<*m*>.

The reset behavior of this field is:

- On a Warm reset, this field resets to an architecturally UNKNOWN value.

Accessing MPAMVPMV_EL2

Accesses to this register use the following encodings in the System register encoding space:

MRS <Xt>, MPAMVPMV_EL2

op0	op1	CRn	CRm	op2
0b11	0b100	0b1010	0b0100	0b001

```

if PSTATE.EL == EL0 then
    UNDEFINED;
elsif PSTATE.EL == EL1 then
    if EL2Enabled() && HCR_EL2.<NV2,NV> == '11' then
        X[t, 64] = NVMem[0x938];
    elsif EL2Enabled() && HCR_EL2.NV == '1' then
        if HaveEL(EL3) && MPAM3_EL3.TRAPLOWER == '1' then
            if Halted() && EDSCR.SDD == '1' then
                UNDEFINED;
            else
                AArch64.SystemAccessTrap(EL3, 0x18);
            else
                AArch64.SystemAccessTrap(EL2, 0x18);
        else
            UNDEFINED;
    elsif PSTATE.EL == EL2 then
        if HaveEL(EL3) && MPAM3_EL3.TRAPLOWER == '1' then
            if Halted() && EDSCR.SDD == '1' then
                UNDEFINED;
            else
                AArch64.SystemAccessTrap(EL3, 0x18);
        else
            X[t, 64] = MPAMVPMV_EL2;
    elsif PSTATE.EL == EL3 then
        X[t, 64] = MPAMVPMV_EL2;

```

MSR MPAMVPMV_EL2, <Xt>

op0	op1	CRn	CRm	op2
0b11	0b100	0b1010	0b0100	0b001

```

if PSTATE.EL == EL0 then
    UNDEFINED;
elsif PSTATE.EL == EL1 then
    if EL2Enabled() && HCR_EL2.<NV2,NV> == '11' then
        NVMem[0x938] = X[t, 64];
    elsif EL2Enabled() && HCR_EL2.NV == '1' then
        if HaveEL(EL3) && MPAM3_EL3.TRAPLOWER == '1' then
            if Halted() && EDSCR.SDD == '1' then
                UNDEFINED;
            else
                AArch64.SystemAccessTrap(EL3, 0x18);
            else
                AArch64.SystemAccessTrap(EL2, 0x18);
        else
            UNDEFINED;
    elsif PSTATE.EL == EL2 then
        if HaveEL(EL3) && MPAM3_EL3.TRAPLOWER == '1' then
            if Halted() && EDSCR.SDD == '1' then
                UNDEFINED;
            else
                AArch64.SystemAccessTrap(EL3, 0x18);
        else
            MPAMVPMV_EL2 = X[t, 64];

```

```
elseif PSTATE.EL == EL3 then  
    MPAMVPMV_EL2 = X[t, 64];
```

7.5 MPAM enable

A single, writable MPAMEN bit exists only in the MPAMn_ELx register for the highest implemented Exception level. The highest Exception level might be EL3, EL2, or EL1. For example, if the highest implemented level is EL3, MPAM3_EL3 would contain the MPAMEN bit. A read-only copy of MPAMEN is present in each of MPAM2_EL2 and MPAM1_EL1 that is implemented and not the highest implemented Exception level.

When the MPAMEN bit is set, MPAM PARTID and PMG are generated as described in this document. When the MPAMEN bit is clear, default values are generated for MPAM physical PARTID and PMG with MPAM_NS reflecting the PE's current security state. See [PARTID spaces and properties on page 3-39](#) for more on default IDs.

The MPAMEN bit is reset to 0.

7.6 SDEFLT

In MPAM v0.1 and from MPAM v1.1, when `MPAMIDR_EL1.HAS_SDEFLT` is 1, the writeable `MPAM3_EL3.SDEFLT` is implemented. When `MPAMIDR_EL1.HAS_SDEFLT` is 0, `MPAM3_EL3.SDEFLT` is RES0, and Secure PARTID generation is as if no SDEFLT functionality is present.

The SDEFLT bit only affects the generation of MPAM PARTIDs from the Secure state. When `MPAM3_EL3.SDEFLT` is 1:

- A Secure physical PARTID is always generated as the default Secure PARTID. If `MPAMIDR_EL1.HAS_FORCE_NS` is 1 and `MPAM3_EL3.FORCE_NS` is 1, the generated PARTID is the default Non-secure PARTID, otherwise it is the default Secure PARTID.
- A PMG is always generated as the default PMG.

When the SDEFLT bit is 0, all accesses have the PARTID and PMG generated as normal. For more information on default IDs, see *PARTID spaces and properties* on page 3-39.

The SDEFLT bit is reset to an UNKNOWN value.

7.6.1 Interaction of SDEFLT and MPAMEN

In MPAM v0.1 and from MPAM v1.1, when `MPAMIDR_EL1.HAS_SDEFLT` is 1, the writeable `MPAM3_EL3.SDEFLT` is implemented:

- When MPAMEN is 0, all accesses from Secure and Non-secure states have the physical PARTID and the PMG generated as 0.
- When MPAMEN is 1 and SDEFLT is 0, all accesses from Secure and Non-secure states have the PARTID and PMG generated as normal.
- When MPAMEN is 1 and SDEFLT is 1:
 - All accesses from Secure state have the physical PARTID as 0 and PMG as 0.
 - All accesses from Non-secure state have the PARTID and PMG generated as normal.

7.7 Lower-EL MPAM register access trapping

When `MPAM3_EL3.TRAPLOWER == 1`, direct accesses to MPAM System registers from EL1 or EL2 that are not UNDEFINED trap to EL3. These registers remain accessible from EL3, thus allowing EL3 to set up the MPAM environments for lower levels that are not MPAM-aware.

`MPAM3_EL3.TRAPLOWER` traps have priority over traps controlled by `MPAM2_EL2` and `MPAMHCR_EL2`.

`HCR_EL2.NV == 1` alters the behavior of `TRAPLOWER` because it makes some `_EL2` and `_EL12` registers that would be UNDEFINED at EL1 trap to EL2. `HCR_EL2.NV == 1` does not affect accesses from EL0, EL2, or EL3. When `HCR_EL2.NV == 1` and `MPAM3_EL3.TRAPLOWER == 1`, accesses to MPAM registers from EL2 are trapped to EL3. See *Nested virtualization extension on page 6-85* for details.

`HCR_EL2.NV2 == 1` alters the behavior of `MPAM3_EL3.TRAPLOWER` because it converts accesses to some `_EL2` and `EL12` registers from EL1 that would be undefined into accesses to memory. See *Enhanced nested virtualization extension on page 6-85* for details.

7.8 FORCE_NS

In MPAMv0.1, when `MPAMIDR_EL1.HAS_FORCE_NS` is 1, `MPAM3_EL3.FORCE_NS` is implemented, and must implement either one of two behaviors:

- Secure PARTIDs are not implemented.
- `FORCE_NS` can be written by software.

If an implementation does not implement Secure PARTIDs, then `MPAM3_EL3.FORCE_NS` is RAO/WI and `MPAM_NS` is always generated as 1 on accesses from Secure state and Non-secure state.

If an implementation allows `MPAM3_EL3.FORCE_NS` to be written by software, then:

- `MPAM3_EL3.FORCE_NS` is reset to 0.
- When `MPAM3_EL3.FORCE_NS` is 0, `MPAM_NS` is generated as 0 on accesses from Secure state.
- When `MPAM3_EL3.FORCE_NS` is 1, `MPAM_NS` is generated as 1 on accesses from Secure state.
- Generation of `MPAM_NS` from Non-secure state is unaffected.

When `MPAMIDR_EL1.HAS_FORCE_NS` is 0, `MPAM3_EL3.FORCE_NS` is RES0, and Secure PARTID generation is as if no `FORCE_NS` functionality is present.

The `FORCE_NS` bit is reset to an UNKNOWN value.

7.9 Reset

MPAM System registers are only minimally reset.

- The MPAMEN bit must be set to 0 by Warm or Cold reset of the PE.
- The [MPAM3_EL3](#).TRAPLOWER bit must be set to 1 by Warm or Cold reset of the PE.
- If [MPAMIDR_EL1](#).HAS_FORCE_NS is 1 and [MPAM3_EL3](#).FORCE_NS is implemented as writeable, [MPAM3_EL3](#).FORCE_NS must be reset to 0 on a Warm or Cold reset of the PE.
- The power and reset domain of each MSC component is specific to that component.

The [MPAM2_EL2](#).TRAPMPAM1EL1, [MPAM2_EL2](#).TRAPMPAM0EL1, and [MPAMHCR_EL2](#).TRAP_MPAMIDR_EL1 bits are not reset if EL3 exists, but all three bits are reset to 1 if EL3 does not exist.

7.10 Unimplemented Exception levels

The Armv8-A architecture permits implementations with or without EL3. Independent from the choice of whether EL3 is implemented or implemented but disabled, the architecture permits implementations with or without EL2.

FEAT_SEL2 is permitted to be implemented or not implemented in v8.4 or later implementations. If FEAT_SEL2 is implemented, it may be enabled or disabled by SCR_EL3.EEL2.

EL1 and EL0 are required in all implementations.

Generally, control bits in the MPAMn_ELx registers and MPAMHCR_EL2 for an unimplemented Exception level are treated as inactive by all other MPAM Exception levels. Details are given in the following subsections.

7.10.1 Effects if EL3 is not implemented

- [MPAM3_EL3](#) is UNDEFINED.
- [MPAM3_EL3.TRAPLOWER](#): All references to this bit behave as if it == 0.
- [MPAM2_EL2.MPAMEN](#) is present and RW if EL2 exists. If EL2 does not exist, [MPAM1_EL1.MPAMEN](#) is present and RW.

7.10.2 Effects if EL2 is implemented in neither Security state

- [MPAM2_EL2](#) is RES0 when accessed from EL3. It is UNDEFINED from all other Exception levels.
- [MPAM2_EL2.TRAPMPAM1EL1](#): All references to it behave as if it == 0.
- [MPAM2_EL2.TRAPMPAM0EL1](#): All references to it behave as if it == 0.
- [MPAM1_EL12](#) is UNDEFINED when accessed from any Exception level.
- [MPAMHCR_EL2](#) is RES0 when accessed from EL3.
- [MPAMHCR_EL2.TRAP_MPAM_IDR_EL1](#): All references to it behave as if it == 0.
- [MPAMHCR_EL2.GSTAPP_PLK](#): All references to it behave as if it == 0.
- [MPAMHCR_EL2.EL1_VPMEN](#): All references to it behave as if it == 0.
- [MPAMHCR_EL2.EL0_VPMEN](#): All references to it behave as if it == 0.
- [MPAMVPMV_EL2](#) is RES0 when accessed from EL3.
- [MPAMVPM0_EL2](#) through [MPAMVPM7_EL2](#) are RES0 when accessed from EL3.

7.10.3 Effects if EL2 is implemented only in Non-secure state, or if implemented but disabled by SCR_EL2.EEL2 = 0 in Secure state

- [MPAM2_EL2](#) is RW when accessed from EL3 or from Non-secure EL2. This register is UNDEFINED from all other Exception levels.
- [MPAM2_EL2.TRAPMPAM1EL1](#): All references to it behave as if it == 0 in the Secure state.
- [MPAM2_EL2.TRAPMPAM0EL1](#): All references to it behave as if it == 0 in the Secure state.
- [MPAM1_EL12](#) is RW from EL3 or from NS_EL2 when [HCR_EL2.E2H](#) == 1. This register is UNDEFINED when accessed from EL1 or EL0 or when [HCR_EL2.E2H](#) == 0.
- [MPAMHCR_EL2](#) is RW when accessed from EL3 or from Non-secure EL2. This register is UNDEFINED from all other EL.
- [MPAMHCR_EL2.TRAP_MPAM_IDR_EL1](#): All references to it behave as if it == 0 in the Secure state.
- [MPAMHCR_EL2.GSTAPP_PLK](#): All references to it behave as if it == 0 in the Secure state.
- [MPAMHCR_EL2.EL1_VPMEN](#): All references to it behave as if it == 0 in the Secure state.

- [MPAMHCR_EL2.EL0_VPMEN](#): All references to it behave as if it == 0 in the Secure state.
- [MPAMVPMV_EL2](#) is RW when accessed from EL3 or from Non-secure EL2. This register is UNDEFINED from all other Exception levels.
- [MPAMVPM0_EL2](#) through [MPAMVPM7_EL2](#) are RW when accessed from EL3 or Non-secure EL2. These registers are UNDEFINED from all other Exception levels.

If an implementation supports Secure state and Secure EL2 does not exist, all behaviors listed in *Effects if EL2 is implemented only in Non-secure state, or if implemented but disabled by SCR_EL2.EEL2 = 0 in Secure state* on page 7-160 must be followed by the MPAM implementation on the Secure side.

If [SCR_EL3.EEL2](#) == 0, Secure EL2 behaves as if it is not implemented, and all behaviors listed in *Effects if EL2 is implemented only in Non-secure state, or if implemented but disabled by SCR_EL2.EEL2 = 0 in Secure state* on page 7-160 must be followed by the MPAM implementation on the Secure side.

If Non-secure EL2 exists, the behaviors in *Effects if EL2 is implemented in neither Security state* on page 7-160 do not apply to the MPAM implementation on the Non-secure side.

Chapter 8

MPAM in MSCs

This chapter contains the following sections:

- *Introduction* on page 8-164.
- *Resource controls* on page 8-165.
- *Resource instance selection* on page 8-166.
- *Security in MSCs* on page 8-171.
- *Virtualization support in system MSCs* on page 8-172.
- *PE with integrated MSCs* on page 8-173.
- *System-wide PARTID and PMG widths* on page 8-174.
- *MPAM interrupts* on page 8-175.
- *MSC support of MPAM for RME* on page 8-179.

8.1 Introduction

This introduction to Memory-System Components, or MSCs, is *informative*. Other sections are normative unless marked as *informative*.

MSCs consist of all units that handle load or store requests issued by any MPAM Requester. These include cache memories, interconnects, Memory Management Units, memory channel controllers, queues, buffers, and rate adaptors.

An MSC could be a part of another system component. For example, a PE might contain caches, which are MSCs. An MSC has resources that are used to process memory requests. The use of a resource could be controlled. A resource that can be controlled according to the PARTID of memory requests is partitioned. A resource might be monitored by a resource usage monitor.

8.1.1 MPAM versions in MSCs

MSCs can be used in MPAM v1.0, v1.1, and in v0.1 under certain conditions. If an MSC does not implement any of the MPAM v1.1 MSC features listed in [MPAM versions for PEs on page 1-22](#), it is version 1.0.

———— **Note** —————

The MPAM version of an MSC is available in [MPAMF_AIDR](#), see [MPAM versions for MSCs on page 1-22](#).

If an MSC implements the extended [MPAMF_IDR](#), or any of the MPAM v1.1 MSC features, it is either MPAM v1.1 or MPAM v0.1. An MSC must not use MPAM v0.1 unless all of these conditions are met:

- The MSC can initiate requests.
- Requests can be initiated in the Secure address space.
- Requests to the Secure address space can have MPAM_NS forced to 1.
- Software that configures the MSC to make requests in the Secure address space:
 - Cannot control the forcing of MPAM_NS.
 - Cannot easily see that MPAM_NS is being forced.

An MSC that supports the four physical address spaces of FEAT_RME must have [MPAMF_IDR.SP4](#) set to 1 and support an MPAM Feature page in each of the four address spaces. See [Four-space MSC on page 8-179](#)

8.2 Resource controls

This section is *normative*.

An MSC optionally contains one or more MPAM resource controls. Although resource controls that control different performance resources have different control parameters, all resource controls are similar in the following aspects that form a common framework:

- Each resource control uses the MPAM PARTID and MPAM_NS signals from the incoming request to select control parameters from an array of Non-secure parameters (when MPAM_NS == 1) or Secure parameters (when MPAM_NS == 0).
- The selected parameters control the behavior of the MSC, either to partition the performance resources or to control the monitoring of performance resource usage.

For more information, see:

- [Model of a resource partitioning control on page 5-56](#) for a model of a resource partitioning control.
- [Chapter 9 Resource Partitioning Controls](#) for more detailed information on resource partitioning controls.
- [Resource instance selection on page 8-166](#) for how these controls are affected when resource instance selection is supported.

8.3 Resource instance selection

Resource instance selection, or RIS, allows support for MSCs with multiple resources. This includes multiple resources with the same resource type or partitioning control. This means that each MSC can only have independent resource controls and two or more resources of the same type when RIS is implemented. In MPAM v0.1 and from MPAM v1.1, this optional feature is implemented when `MPAMF_IDR.HAS_RIS` is 1.

This section provides more details on:

- [RIS values](#).
- [RIS controls in MPAMCFG_PART_SEL](#).
- [RIS controls in MSMON_CFG_MON_SEL](#) on page 8-169.
- [Effects of MPAMCFG_PART_SEL.RIS on values read from other registers](#) on page 8-167.
- [Selecting a resource to monitor](#) on page 8-169.
- [Undefined RIS values](#) on page 8-170.
- [Reporting errors involving RIS](#) on page 8-170.

8.3.1 RIS values

Each resource that has MPAM resource partitioning controls or can be monitored by an MPAM resource usage monitor has a RIS value.

The RIS value in `MPAMCFG_PART_SEL.RIS` is used to select which resource to describe in ID register fields. `MPAMCFG_PART_SEL.RIS` is also used along with `MPAMCFG_PART_SEL.PART_SEL` to select the resource and PARTID when accessing `MPAMCFG_*` resource control registers.

MPAM resource monitors are usually associated with a resource instance, and the RIS value for that resource instance is also used in `MSMON_CFG_MON_SEL.RIS` to select the monitors associated with that resource.

RIS values are IMPLEMENTATION DEFINED. Any two resources in an MSC must have different RIS values. The RIS value is assigned to a resource in the MSC.

`MPAMF_IDR.RIS_MAX` gives the largest value of RIS that is defined for the MSC. A RIS value from 0 to `RIS_MAX` can be assigned to any partitioned or monitored resource. There is no requirement for every RIS value to be assigned to a partitioned or monitored resource.

As software for MPAMv1.0 would not set the value of the RIS field to any value other than 0, the only resource that can be identified and controlled by software that is not aware of this feature is resource instance 0.

8.3.2 RIS controls in MPAMCFG_PART_SEL

The value in `MPAMCFG_PART_SEL.RIS` selects the resource instance that is:

- Described by the MPAMF ID registers.
- Controlled by accessing the `MPAMCFG_*` registers.

8.3.3 Effects of MPAMCFG_PART_SEL.RIS on partitioning controls

To access control settings for a particular resource instance and PARTID, `MPAMCFG_PART_SEL.PART_SEL` is set to the PARTID and `MPAMCFG_PART_SEL.RIS` is set to the value associated with that resource instance. Accesses to additional `MPAMCFG_*` registers made without changing `MPAMCFG_PART_SEL` can be used to read and write additional control settings for that resource instance and partition.

If a control applies to all resource instances, this common control must be accessed with `MPAMCFG_PART_SEL.RIS` set to 0.

If there is only a single resource instance in an MSC, all controls must be associated with `MPAMCFG_PART_SEL.RIS` set to 0.

If an `MPAMCFG` register is accessed when `MPAMCFG_PART_SEL.RIS` is set to a resource instance that does not support the accessed control, then the behavior is CONSTRAINED UNPREDICTABLE, see [RIS in MPAMCFG_PART_SEL.RIS does not have partitioning control \(errorcode == 9\)](#) on page 12-395.

8.3.4 Effects of MPAMCFG_PART_SEL.RIS on values read from other registers

Fields within other registers reflect the capabilities of the resource instance that has been selected by MPAMCFG_PART_SEL.RIS, and so might have different values in different resource instances.

The effects of RIS on the MPAM identification registers are shown in Table 8-1

Table 8-1 MPAM ID register fields affected by a resource instance

Register	Field	Affected by MPAMCFG_PART_SEL.RIS
MPAMF_CCAP_IDR	CMAX_WD	This field is permitted to vary between resource instances.
	HAS_CMAX_SOFTLIM	This field is permitted to vary between resource instances.
	NO_CMAX	This field is permitted to vary between resource instances.
	HAS_CMIN	This field is permitted to vary between resource instances.
	HAS_CASSOC	This field is permitted to vary between resource instances.
	CASSOC_WD	This field is permitted to vary between resource instances.
MPAMF_CPOR_IDR	CPBM_WD	This field is permitted to vary between resource instances.
MPAMF_CSUMON_IDR	HAS_CAPTURE	This field is permitted to vary between resource instances.
	CSU_RO	This field is permitted to vary between resource instances.
	NUM_MON	This field is permitted to vary between resource instances.
	HAS_XCL	This field is permitted to vary between resource instances.
	HAS_CEVNT_OFLW	This field is permitted to vary between resource instances.
	HAS_CEVNT_CAPT	This field is permitted to vary between resource instances.
MPAMF_IDR	NO_IMPL_MSMON	MPAMF_IMPL_IDR describes no resource usage monitors.
	NO_IMPL_PART	MPAMF_IMPL_IDR describes no resource partitioning controls.
	HAS_MSMON	The resource usage monitors described in MPAMF_MSMON_IDR, otherwise this field is 0b0.
	HAS_IMPL_IDR	The IMPLEMENTATION DEFINED features described in MPAMF_IMPL_IDR, otherwise this field is 0b0.
	HAS_PRI_PART	The priority partitioning described in MPAMF_PRI_IDR, otherwise 0b0.
	HAS_MBW_PART	The memory bandwidth partitioning described in MPAMF_MBW_IDR, otherwise 0b0.
	HAS_CPOR_PART	The cache portion partitioning described in MPAMF_CPOR_IDR, otherwise 0b0.
	HAS_CCAP_PART	The cache capacity partitioning described in MPAMF_CCAP_IDR, otherwise 0b0.
MPAMF_IMPL_IDR	IMPLFEAT	The IMPLFEAT contents vary according to the resource instance selected, and cannot be specified by the architecture.
MPAMF_MSMON_IDR	MSMON_MBWU	The memory bandwidth usage monitors of the resource, otherwise this field is 0b0.
	MSMON_CSU	The cache storage usage monitors of the selected resource instance. Otherwise this field is 0b0.

Table 8-1 MPAM ID register fields affected by a resource instance (continued)

Register	Field	Affected by MPAMCFG_PART_SEL.RIS
MPAMF_PRI_IDR ^a	DSPRI_WD	The downstream priority width. Ignored if MPAMF_PRI_IDR.HAS_DSPRI is set to 0.
	DSPRI_0_IS_LOW	The downstream priority encoded with 0 being the low priority. Ignored if MPAMF_PRI_IDR.HAS_DSPRI is set to 0.
	HAS_DSPRI	The downstream priority control.
	INTPRI_WD	The internal priority width. Ignored if MPAMF_PRI_IDR.HAS_INTPRI is set to 0.
	INTPRI_0_IS_LOW	The internal priority encoded with 0 being low priority. Ignored if MPAMF_PRI_IDR.HAS_INTPRI is set to 0.
	HAS_INTPRI	The internal priority control.
MPAMF_MBW_IDR	BWPBM_WD	This field is permitted to vary between resource instances.
	HAS_PROP	This field is permitted to vary between resource instances.
	HAS_PBM	This field is permitted to vary between resource instances.
	HAS_MAX	This field is permitted to vary between resource instances.
	HAS_MIN	This field is permitted to vary between resource instances.
	BWA_WD	This field is permitted to vary between resource instances.
MPAMF_MBWUMON_IDR	HAS_CAPTURE	This field is permitted to vary between resource instances.
	HAS_RWBW	This field is permitted to vary between resource instances.
	HAS_LONG	This field is permitted to vary between resource instances.
	LWD	This field is permitted to vary between resource instances.
	SCALE	This field is permitted to vary between resource instances.
	NUM_MON	This field is permitted to vary between resource instances.
	HAS_OFLOW_LNKG	This field is permitted to vary between resource instances.
	HAS_OFSR	This field is permitted to vary between resource instances.
	HAS_CEVNT_OFLOW	This field is permitted to vary between resource instances.
HAS_CEVNT_CAPT	This field is permitted to vary between resource instances.	

- a. If the priority partitioning is local to the resource instance, then all fields might vary between resource instances. If the priority partitioning operates at the MSC level, then [MPAMF_PRI_IDR](#) should be non-zero only when [RIS](#) is 0.

The following registers are not affected by [RIS](#):

- [MPAMF_AIDR](#).
- [MPAMF_ECR](#).
- [MPAMF_ESR](#).
- [MPAMF_IIDR](#).
- [MPAMF_PARTID_NRW_IDR](#).
- [MPAMF_SIDR](#).
- [MPAMCFG_PART_SEL](#).
- [MPAMF_ERR_MSI_ADDR_H](#).
- [MPAMF_ERR_MSI_ADDR_L](#).
- [MPAMF_ERR_MSI_ATTR](#).
- [MPAMF_ERR_MSI_DATA](#).
- [MPAMF_ERR_MSI_MPAM](#).

[MPAMCFG](#) resource control settings are selected by the [MPAMCFG_PART_SEL](#) register. The [RIS](#) field selects the resource instance and the [PARTID_SEL](#) field selects the [PARTID](#) of the resource control setting accessed. The [PARTID](#) space of the resource control is selected by the address space accessed.

[MPAMCFG_PART_SEL](#).RIS accesses different resource instances. The resource instance selected can have control settings registers for accessing the controls for the selected resource.

The following resource configuration registers access resource control settings for different resources as selected by [MPAMCFG_PART_SEL](#).RIS:

- [MPAMCFG_CASSOC](#).
- [MPAMCFG_CASSOC](#).
- [MPAMCFG_CMIN](#).
- [MPAMCFG_CPBM<n>](#).
- [MPAMCFG_MBW_MAX](#).
- [MPAMCFG_MBW_MIN](#).
- [MPAMCFG_MBW_PBM<n>](#).
- [MPAMCFG_MBW_PROP](#).
- [MPAMCFG_PRI](#).

The following MPAM control settings are global to all resources in the MSC:

- [MPAMCFG_DIS](#).
- [MPAMCFG_EN](#).
- [MPAMCFG_EN_FLAGS](#).
- [MPAMCFG_INTPARTID](#).
- [MPAMCFG_MBW_WINWD](#).
- [MPAMCFG_PART_SEL](#).

8.3.5 RIS controls in [MSMON_CFG_MON_SEL](#)

The value in [MSMON_CFG_MON_SEL](#).RIS selects the resource instance that is accessed by:

- The [MSMON_CFG_*](#) monitor configuration registers.
- The [MSMON_*](#) monitor and monitor capture registers.
- [MSMON_CSU_OFSR](#) and [MSMON_MBWU_OFSR](#) overflow status registers.

To access the configuration, value and capture registers associated with a monitor, the value of [MSMON_CFG_MON_SEL](#).RIS should be set to match the RIS value associated with that monitor. Monitors not associated with any particular resource or associated with the MSC must be associated with [MPAMCFG_PART_SEL](#).RIS == 0.

———— **Note** —————

Monitoring ID registers, [MPAMF_MSMON_IDR](#), [MPAMF_MBWUMON_IDR](#), and [MPAMF_CSUMON_IDR](#), are not affected by [MSMON_CFG_MON_SEL](#).RIS. These registers are affected by [MPAMCFG_PART_SEL](#).RIS.

[MSMON_OFLOW_MSI_ADDR_H](#), [MSMON_OFLOW_MSI_ADDR_L](#), [MSMON_OFLOW_MSI_ATTR](#), [MSMON_OFLOW_MSI_DATA](#), [MSMON_OFLOW_MSI_MPAM](#), and [MSMON_OFLOW_SR](#) are not affected by [MSMON_CFG_MON_SEL](#).RIS.

8.3.6 Selecting a resource to monitor

To select the monitors for a particular resource instance, the value of [MSMON_CFG_MON_SEL](#).RIS must be the same value as used in [MPAMCFG_PART_SEL](#).RIS. Monitors that are not associated with an MPAM partitioned resource instance must be selected with a RIS value of 0.

To access a monitor for a particular resource, the [MSMON_CFG_MON_SEL](#).RIS must be set to the resource instance. Then one or more [MSMON_CFG_*](#) registers for the particular monitor are accessed.

Any access to a [MSMON_*](#) register address will access the register associated with the resource instance value held in [MSMON_CFG_MON_SEL](#).RIS. The exceptions to this are accesses to the [MSMON_CFG_MON_SEL](#) and [MSMON_CAPT_EVNT](#) registers, which are not affected by the value held in [MSMON_CFG_MON_SEL](#).RIS.

8.3.7 Undefined RIS values

This section covers behaviors when the value of `MPAMCFG_PART_SEL.RIS` or `MSMON_CFG_MON_SEL.RIS`:

- Is greater than `MPAMF_IDR.RIS_MAX`.
- Does not correspond to an MPAM resource implemented in this MSC.
- Does correspond to an implemented MPAM resource, but the selected resource does not implement the control or monitor that has been accessed.

An MSC is permitted to:

- Implement fewer RIS bits than the architecture defines, though it must implement at least enough bits to represent `MPAMF_IDR.RIS_MAX`.
- Leave some RIS values that are within the range of 0 to `MPAMF_IDR.RIS_MAX` as undefined.
- Use only the implemented bits to decode RIS for selecting a resource instance.

Undefined resources that are within the range can still be identified. This is because the `HAS_*` fields within the ID registers all read as 0 when `MPAMCFG_PART_SEL.RIS` selects an undefined resource. All RIS values greater than `MPAMF_IDR.RIS_MAX` are undefined.

If software honors `MPAMF_IDR.RIS_MAX` and avoids accessing any *Memory-mapped registers* (MMR) that are not indicated with the corresponding `HAS_*` fields in the ID registers for that resource instance, it will not cause any RIS-related errors.

For more information on behavior caused by undefined RIS values, see:

- [Undefined RIS in MPAMCFG_PART_SEL.RIS \(errorcode == 8\) on page 12-395.](#)
- [RIS in MPAMCFG_PART_SEL.RIS does not have partitioning control \(errorcode == 9\) on page 12-395.](#)
- [Undefined RIS in MSMON_CFG_MON_SEL.RIS \(errorcode == 10\) on page 12-395.](#)
- [RIS selected by MSMON_CFG_MON_SEL.RIS does not have monitor type \(errorcode == 11\) on page 12-396.](#)

Reading an MPAMF ID register when MPAMCFG_PART_SEL is an undefined RIS value

Access to an MPAMF ID register when `MPAMCFG_PART_SEL.RIS` is an undefined value must produce an ID register value where all `HAS_*` fields read as 0. This action does not produce an error in `MPAMF_ESR` or signal an error interrupt.

8.3.8 Reporting errors involving RIS

Software could misconfigure the RIS fields in `MPAMCFG_PART_SEL` and `MSMON_CFG_MON_SEL` registers, possibly resulting in errors. See [Optionality of error detection and reporting on page 12-403](#).

When an error is reported that involves a RIS value, the `MPAMF_ESR.RIS` field must be set to:

- For errors involving `MPAMCFG_*` register accesses, the `MPAMCFG_PART_SEL.RIS`.
- For errors involving `MSMON_*` register accesses, the `MSMON_CFG_MON_SEL.RIS` value.

For MPAM errors that do not capture the RIS field in `MPAMF_ESR.RIS` as shown in [Table 12-1 on page 12-393](#), `MPAMF_ESR.RIS` should be set to 0.

8.4 Security in MSCs

MPAM behavior in an MSC is affected in the following ways:

- Certain memory-mapped registers are only accessible from Secure address space (NS == 0).
- PARTIDs communicated to the MSC are augmented with a single MPAM_NS bit as 0, indicating that the MPAM PARTID in the request is to be interpreted in the Secure PARTID space. This is true even if the access from Secure state software was to the Non-secure (NS == 1) address space. MPAM_NS is always 0 if the PE is in the Secure state when the request is made, but the address of the request could be either a Secure or a Non-secure address. If the PE is in the Non-secure state, both the MPAM_NS bit and the address NS bit must be 1. See *PARTID spaces and properties* on page 3-39.
- When an MSC receives a transaction with MPAM_NS == 0, it accesses control settings for the Secure PARTID. If it receives a request with MPAM_NS == 1 it accesses the control settings for the Non-secure PARTID space.
- When programming the control settings for a Secure partition in an MSC, the settings must be stored by an access to the configuration registers in the Secure address space (NS == 0). See *Programming configuration of MPAM settings for Secure IDs*.
- When programming the control settings for a Non-secure partition in an MSC, the settings must be stored by an access to the configuration registers in the Non-secure address space (NS == 1).

8.4.1 Programming configuration of MPAM settings for Secure IDs

Configuration parameters for a Secure PARTID or Secure MPAM monitor can only be programmed from a Secure memory access (NS == 0):

- There are Secure and Non-secure versions of the MPAMCFG_PART_SEL and MSMON_CFG_MON_SEL. These two versions are accessed at the same address, differentiated by the value of the NS bit.
- Accessing an MPAMCFG_* register with a Secure (NS == 0) request accesses the configuration of a resource control of the Secure PARTID space that is selected by the PARTID in MPAMCFG_PART_SEL_S.
- Accessing an MPAMCFG_* register with a Non-secure (NS == 1) request accesses the configuration of a resource control of the Non-secure PARTID space that is selected by the PARTID in MPAMCFG_PART_SEL_NS.

8.4.2 Using Secure and Non-secure MPAM PARTIDs

When a request is processed by an MSC with MPAM resource controls, PARTID, PMG, and MPAM_NS control the partitioning control settings used and monitoring events triggered.

The PARTID and MPAM_NS of a request select the partitioning configuration from a table of PARTID configurations for each implemented resource control. The MPAM_NS bit in the request selects between the Non-secure configuration table and the Secure configuration table. The two tables do not need to have the same size. For example, the Secure configuration table might be much smaller. Tables are not required to be power-of-two sized.

A monitoring event is triggered if the PARTID, PMG, and MPAM_NS in a request match those configured in a performance monitor.

8.5 Virtualization support in system MSCs

MSCs do not see virtual PARTIDs. The PARTID generation in a Requester resolves any virtual PARTID into a physical PARTID that is communicated with the memory-system request. Therefore, MSCs only handle physical PARTIDs.

8.5.1 Hypervisor emulates guest accesses to partitioning and monitoring configurations

Accesses from a guest to the configuration registers of all MSCs, and to the System registers that configure the PE MSCs, may be emulated by the host hypervisor. This allows virtual PARTID mapping to be emulated and hypervisor policies governing resource partitioning to be applied.

Configuration and reconfiguration of control settings in MSCs are expected to be rare occurrences.

Arm recommends that the memory-mapped configuration registers of an MSC should be placed at a 64-KB-aligned address to permit an access trap on that page in the stage-2 page tables. The stage-2 access traps are taken to EL2 where the hypervisor can emulate the access. For more information on recommended configurations of memory-mapped registers of an MSC, see [MPAM feature page on page 11-217](#).

8.6 PE with integrated MSCs

A PE might have integrated MSC behaviors. These are discovered and configured in the same way as other MSCs.
See [Chapter 11 Memory-mapped Registers](#)

8.7 System-wide PARTID and PMG widths

This section is informative.

The behavior of an MSC is **CONSTRAINED UNPREDICTABLE** if it receives an MPAM PARTID or PMG outside the range it supports. For more information, see [Behavior of configuration reads and writes with errors on page 12-398](#).

For predictable behavior, the PARTID on a request by a Requester should be in the range of 0 to:

- If the request is `MPAM_NS == 1`, the smallest maximum Non-secure PARTID supported by any MSC that might be accessed by that request.
- If the request is `MPAM_NS == 0`, the smallest maximum Secure PARTID supported by any MSC that might be accessed by that request.

And, the PMG on a request by a Requester should be in the range of 0 to:

- If the request is `MPAM_NS == 1`, the smallest maximum Non-secure PMG supported by any MSC that might be accessed by that request.
- If the request is `MPAM_NS == 0`, the smallest maximum Secure PMG supported by any MSC that might be accessed by that request.

The smallest maximum values for PARTID and PMG in Non-secure and Secure spaces can be computed from firmware during discovery. PARTID and PMG widths are reported through ID registers in PEs and MSCs. See sections [Appendix B MSC Firmware Data, System register descriptions on page 7-99](#), and [Determining presence and location of MMRs on page 11-216](#).

8.8 MPAM interrupts

This section is *normative*.

There are two types of interrupts that an MPAM MSC could produce:

- MPAM Error Interrupt.
- MPAM Overflow Interrupt.

8.8.1 MPAM Error Interrupt

MPAM errors in MSCs are described in [Error conditions in accessing memory-mapped registers on page 12-393](#).

MPAM errors that are detected in an MSC are recorded in `MPAMF_ESR` and signaled to software via an MPAM error interrupt if enabled by `MPAMF_ECR.INTEN == 1`.

If an MSC cannot encounter any of the error conditions listed in [Error conditions in accessing memory-mapped registers on page 12-393](#), both the `MPAMF_ESR` and `MPAMF_ECR` must be RAZ/WI. An error cannot be encountered if the MSC:

- Does not support any feature of MPAM that can raise that error.
- Is designed so that the error cannot occur.
- Is permitted to have no detection for that error and does not implement detection for the error, see [Required error condition detection on page 12-403](#).

If an MSC supports both Secure and Non-secure address spaces, `MPAMF_ESR` and `MPAMF_ECR` will each have a Secure instance and a Non-secure instance. The Secure registers control and generate Secure MPAM error interrupts, while the Non-secure registers control and generate Non-secure MPAM error interrupts.

The MPAM error interrupt can be implemented in an MSC as a level-sensitive interrupt or as an edge-triggered interrupt. The interrupt behavior depends on whether level-sensitive or edge-triggered interrupts are used.

- Arm recommends that the MPAM error interrupt be implemented as a level-sensitive interrupt.
- The mechanism by which an interrupt request from an MSC resource monitor generates an FIQ or IRQ exception is IMPLEMENTATION DEFINED.
- Arm recommends that an MSC implements two MPAM error interrupt signals, one for the Secure MPAM error interrupt and another for the Non-secure MPAM error interrupt.
- Arm recommends that MPAM error interrupt requests:
 - Translate into an `MPAM_ERR_IRQ` signal, so that they are observable to external devices.
 - If the MSC is integrated into a PE, connect to inputs on an IMPLEMENTATION DEFINED generic interrupt controller as a Private Peripheral Interrupt (PPI) or a Locality-specific Peripheral Interrupt (LPI) for that PE. See the *Arm Generic Interrupt Controller Architecture Specification, GIC architecture version 3.0 and version 4.0* for information about PPIs, LPIs, and SPIs.
 - If the MSC is not integrated into a PE, connect to inputs on an IMPLEMENTATION DEFINED generic interrupt controller as a System Peripheral Interrupt (SPI) or Locality-Specific Peripheral Interrupt (LPI).

Level-sensitive interrupts

When using level-sensitive interrupts, the interrupt is active when `MPAMF_ESR.ERRCODE` is non-zero.

Software can make a level-sensitive interrupt active by writing non-zero to `MPAMF_ESR.ERRCODE`.

An interrupt service routine is expected to write `0b0000` into `MPAMF_ESR.ERRCODE` to clear the interrupt.

If the MSC supports signaling the MPAM error interrupt through a *Message signaled interrupt* (MSI), the interrupt must be edge-triggered.

See also [Chapter 12 Errors in MSCs](#).

Edge-triggered interrupts

When using edge-triggered interrupts, the interrupt edge is generated when `MPAMF_ESR.ERRCODE` is written due to an error.

An edge-triggered interrupt is not generated when software writes to `MPAMF_ESR`.

An interrupt service routine does not need to clear an edge-triggered interrupt.

If the MSC supports signaling the MPAM error interrupt through an MSI, the interrupt must be edge-triggered.

See [Chapter 12 Errors in MSCs](#) for other reasons for an interrupt service routine to clear `MPAMF_ESR`.

Support for MSI writes to signal error interrupts

Message signaled interrupts (MSIs) are signaled using a memory write that is usually directed at an interrupt translation service.

The support for error MSIs is identified by the `MPAMF_IDR.{HAS_ERR_MSI, HAS_ESR}` fields.

The registers that contain the error MSI write configuration are:

- `MPAMF_ERR_MSI_ADDR_L`.
- `MPAMF_ERR_MSI_ADDR_H`.
- `MPAMF_ERR_MSI_ATTR`.
- `MPAMF_ERR_MSI_DATA`.
- `MPAMF_ERR_MSI_MPAM`.

Instances of these MSI configuration registers exist in each of the Secure physical address space and the Non-secure physical address space. The set of these registers in an address space configures the error MSI write for errors from the `MPAMCFG_*` or `MPAMF_*` registers in that address space.

Errors can also be raised by errors in requests. Errors in requests which have the PARTID space selected by `MPAM_NS` of 0 are signaled as Secure errors using the MSI write information from the `MPAMF_ERR_MSI_*` registers in the Secure address space. Errors in requests which have the PARTID space selected by `MPAM_NS` of 1 are signaled as Non-secure errors using the MSI write information from the `MPAMF_ERR_MSI_*` registers in the Non-secure space.

8.8.2 MPAM overflow interrupt

A monitor could overflow, especially if it is a type of monitor that accumulates counts. If it is possible for a type of monitor to overflow, there are bits in `MSMON_CFG_*_CTL` to control the behavior on overflow (*Overflow status bit on page 10-210*).

Support of an overflow interrupt is optional in an MSC. If the MSC has monitors that can overflow, Arm recommends that the MPAM overflow interrupt be implemented.

When an MPAM monitor instance overflows, it sets the `OFLOW_STATUS` flag in the monitor instance's control register. If the `OFLOW_STATUS` flag was previously 0 and `OFLOW_INTR` bit is 1, an overflow interrupt is signaled if the MSC implements overflow interrupts.

If an MSC supports both Secure and Non-secure address spaces, `MSMON_CFG_*_CTL` registers and `MSMON_MBWU` and `MSMON_CSU` registers that are implemented have Secure and Non-secure instances. Secure instances of `MSMON_CFG_*_CTL.OFLOW_INTR` control whether a Secure MPAM overflow interrupt is generated when the corresponding Secure counter instance overflows. Non-secure instances of `MSMON_CFG_*_CTL.OFLOW_INTR` control whether a Non-secure MPAM overflow interrupt is generated when the corresponding Non-secure counter instance overflows.

- The mechanism by which an interrupt request from an MSC resource monitor generates an FIQ or IRQ exception is IMPLEMENTATION DEFINED.
- Arm recommends that an MSC implements two MPAM overflow interrupt signals, one for the Secure MPAM overflow interrupt and another for the Non-secure MPAM overflow interrupt.

- Arm recommends that MPAM overflow interrupt requests:
 - Translate into an MPAM_OF_IRQ signal, so that they are observable to external devices.
 - If the MSC is integrated into a PE, connect to inputs on an IMPLEMENTATION DEFINED generic interrupt controller as a Private Peripheral Interrupt (PPI) or a Locality-specific Peripheral Interrupt (LPI) for that PE. See the *Arm Generic Interrupt Controller Architecture Specification, GIC architecture version 3.0 and version 4.0* for information about PPIs, LPIs and SPIs.
 - If the MSC is not integrated into a PE, connect to inputs on an IMPLEMENTATION DEFINED generic interrupt controller as a System Peripheral Interrupt (SPI) or Local Peripheral Interrupt (LPI).

The interrupt is reset by writing 0 to the OFLOW_STATUS field of all overflowed monitor instances MSMON_CFG_*_CTL register.

If the MSC supports signaling monitor overflow interrupts through an MSI, the MPAM monitor overflow interrupt must be edge-triggered.

Support for MSI writes to signal overflow interrupts

MSIs are signaled using a memory write that is usually directed at an interrupt translation service.

The support for the monitor overflow interrupt is identified by the MPAMF_MSMON_IDR.{HAS_OFLW_INTR, HAS_OFLW_MSI} fields.

The registers that contain the error MSI write configuration are:

- [MSMON_OFLOW_MSI_ADDR_L](#)
- [MSMON_OFLOW_MSI_ADDR_H](#).
- [MSMON_OFLOW_MSI_ATTR](#).
- [MSMON_OFLOW_MSI_DATA](#).
- [MSMON_OFLOW_MSI_MPAM](#).

Instances of these MSI configuration registers exist in each of the Secure physical address space and the Non-secure physical address space. The set of these registers in an address space configures the overflow MSI write from overflow events of monitors accessible in that address space.

Monitor overflow status register

The optional [MSMON_OFLOW_SR](#) register gives a summary of the overflow status flags (OFLOW_STATUS and OFLOW_STATUS_L) for each RIS and for each monitor type.

This register contains a flag bit per RIS value. Each flag is 0 if all of the OFLOW_STATUS and OFLOW_STATUS_L bits of all monitor types and all instances of each type for the resource instance are 0. Each flag is 1 if any of the overflow status bits for any monitor instance of any type for the resource instance are 1.

The register also contains a flag bit for each monitor type. A monitor type flag is 1 if any monitor instance of the type for the resource instance has the OFLOW_STATUS or OFLOW_STATUS_L bit as 1.

[MSMON_OFLOW_SR](#) is read-only. The flags are reset when the OFLOW_STATUS and OFLOW_STATUS_L bits monitored by that flag have all be reset to zero.

The presence of [MSMON_OFLOW_SR](#) is indicated by [MPAMF_MSMON_IDR.HAS_OFLOW_SR](#) == 1.

Monitor type overflow status bitmap registers

In an implementation that has many monitor instances of a monitor type, the number of monitor instances to scan for overflows is large even after consulting [MSMON_OFLOW_SR](#) to eliminate most of the RIS and monitor types. To probe one monitor instance requires that the monitor overflow interrupt service routine set [MSMON_CFG_MON_SEL](#) to a monitor instance, read [MSMON_CFG_<type>_CTL](#) and check one or two bits in that register to see if the OFLOW_STATUS or OFLOW_STATUS_L bit is set.

To assist the scanning of many monitor instances, optional overflow status bitmap registers for a monitor type are available for implementation. These overflow status bitmaps can greatly accelerate the scanning.

Each MPAM monitor type can have an optional overflow status register that shows the overflow status flags in a bitmap of 32 monitor instances. The monitor instances shown are selected in [MSMON_CFG_MON_SEL](#) where the RIS field selects the resource instance and the MON_SEL field AND 0xFFE0 selects the lowest of the contiguous 32 monitor instances reported in the bitmap.

For the CSU monitor type, the CSU overflow status register is [MSMON_CSU_OFSR](#). The presence of this register is discoverable in [MPAMF_CSUMON_IDR.HAS_OFSR](#).

———— **Note** —————

In most implementations, CSU monitor instances will not be able to overflow as the maximum value in [MSMON_CSU](#) is known at design time and will fit within the architectural maximum of [MSMON_CSU](#). In such an implementation, there will be no CSU monitor instance overflows and [MSMON_CSU_OFSR](#) has no value.

For the MBWU monitor type, the MBWU overflow status register is [MSMON_MBWU_OFSR](#). The presence of this register is discoverable in [MPAMF_MBWUMON_IDR.HAS_OFSR](#).

8.9 MSC support of MPAM for RME

An RME system supports 4 physical address spaces. MPAM for RME supports the 4 address spaces and 4 PARTID spaces. The MPAM system environment of an RME system is described in [The MPAM for RME system on page 5-61](#).

- An MSC that supports the 4 physical address spaces and 4 PARTID spaces is defined as a *four space MPAM MSC*.
- An MSC that supports only 2 physical address spaces and 2 PARTID spaces is defined as a *two space MPAM MSC*.
- Non-MPAM components support either 1, 2 or 4 address spaces but do not support MPAM at all. Non-MPAM devices have no regulated resources and must not have MPAM devices downstream. See [Non-MPAM components on page 5-66](#).
- Other combinations of physical address space support and PARTID space support are not permitted.

4 PARTID spaces must be supported in the levels of interconnect that connect RME PEs, but some MSCs might support MPAM with support for only 2 PARTID spaces. See [MPAM for RME propagation of MPAM_SP with requests on page 4-48](#).

The MPAM PARTID space in a request and the physical address space accessed by the request are independent in the request. The associations of physical address space and PARTID space are part of the request generation process at a Requester. An MSC must not assume any association between the PARTID space of a request and the physical address space of the request.

A four space MSC is permitted to use either a Non-secure MPAM error interrupt or a Secure MPAM error interrupt for reporting an error associated with the Root or Realm PARTID spaces.

8.9.1 Four-space MSC

An MSC that fully supports RME and MPAM must have 4 PARTID spaces and 4 physical address spaces.

In an MSC that supports 4 PARTID spaces and 4 physical address spaces, the `MPAMF_IDR.SP4` bit must be 1 when read from any address space and, if RIS is supported, with any `MPAMCFG_PART_SEL.RIS` value.

`MPAMF_BASE_s`, `MPAMF_BASE_ns`, `MPAMF_BASE_rt`, `MPAMF_BASE_rl` must all be defined in the firmware table description of the MSC.

The MPAM memory-mapped registers in each address space are at the offsets from the MPAM Feature Page Base address in that address space. [Table 8-2](#) shows the relationship of address space, the MPAM feature page base address symbol and the contents of that MPAM feature page.

Table 8-2 Relationship of address space, MPAM feature page base address symbol and a description of the contents of that MPAM feature page

Address Space	MPAM Feature Page Base	Description
Non-Secure	<code>MPAMF_BASE_ns</code>	MPAM MSC registers in the Non-secure address space describe and access controls and monitors for Non-secure PARTID space.
Secure	<code>MPAMF_BASE_s</code>	MPAM MSC registers in the Secure address space describe and access controls and monitors for Secure PARTIDs.
Realm	<code>MPAMF_BASE_rl</code>	MPAM MSC registers in the Realm address space describe and access controls and monitors for the Realm PARTID space
Root	<code>MPAMF_BASE_rt</code>	MPAM MSC registers in the Root address space describe and access controls and monitors for the Root PARTID space

The offsets of MPAM memory-mapped registers from the MPAM Feature Page base address are the same for each MPAM Feature page and in each address space. See [Table 11-1 on page 11-222](#) for all MPAM MSC registers. Added fields and accessors for the two physical address spaces for RME are described in this chapter. See [Chapter 11 Memory-mapped Registers](#) for Memory-mapped registers from the MPAMF_BASE_* for that address space.

See [Minimum required MPAM memory-mapped registers on page 11-219](#) for the required minimum set of MPAM registers accessible from the MPAM Feature Page in any address space. In each address space the MPAM features of the MSC in that address space are described by decoding the fields in MPAMF_IDR. This indicates that additional ID registers are present and further describe the features. MPAM has no requirement that the resource controls and monitors in one address space are the same as those described in another address space.

Instances of the MPAMCFG_* registers must exist in each of the 4 address spaces where MPAMF_*IDR.HAS_* is 1 for a feature that uses those registers.

There must be an instance of MPAMCFG_PART_SEL in each of the 4 address spaces unless there are no resource controls or resource instances in the PARTID space whose control registers are accessed through that physical address space.

Instances of the MSMON_* registers must exist in each address space where the ID registers indicate that the monitor exists.

There must be an instance of MSMON_CFG_MON_SEL in each of the 4 address spaces that contain any monitor registers.

MPAMF_ESR and MPAMF_ECR must exist in each address space in each of the 4 address spaces where MPAMF_IDR.HAS_ESR is 1.

Chapter 9

Resource Partitioning Controls

This chapter contains the following sections:

- *Introduction* on page 9-182.
- *Partition resources* on page 9-183.
- *Standard partitioning control interfaces* on page 9-184.
- *Vendor or implementation-specific partitioning control interfaces* on page 9-196.
- *Measurements for controlling resource usage* on page 9-197.
- *PARTID narrowing* on page 9-198.
- *System reset of MPAM controls in MSCs* on page 9-199.
- *About the fixed-point fractional format* on page 9-200.

9.1 Introduction

This introduction to memory-system partitioning is *informative*. Other sections are *normative* unless marked as *informative*.

Software assigns VMs and applications to a partition. The hypervisor can assign VMs to partitions, and operating systems can assign applications to partitions. This specification does not address how such assignments are made by software.

A memory-system partition is associated with a software environment on a PE by loading an MPAMn_ELx register with PARTID_I and PARTID_D. An EL2 hypervisor loads MPAM1_EL1 with the partition IDs when context-switching between VMs. An EL1 operating system loads MPAM0_EL1 with the partition IDs when context-switching between applications. The PARTIDs loaded into fields of MPAMn_ELx for instruction and data accesses are used for requests when running software at ELn. The PARTID on memory-system requests connects the software environment to the resource partitioning controls in the MSCs that handle the requests.

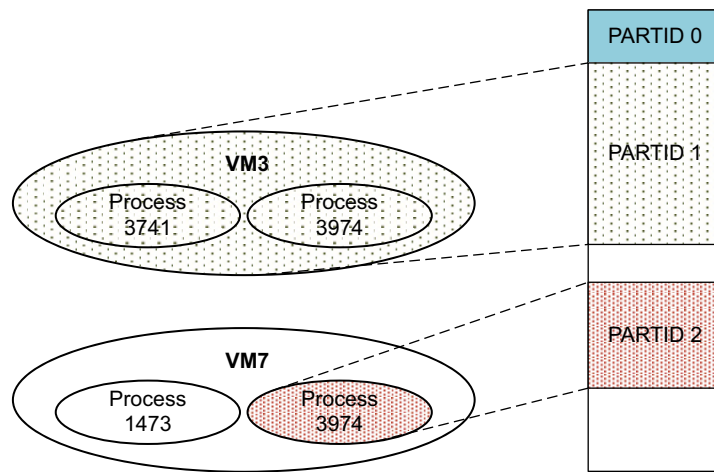

Figure 9-1 Partitioning, VMs, and OS processes

The PARTID of a request controls uses of each MSC’s performance resources. An MSC receives a PARTID with each request. The PARTID may be used within the component to select resource controls for the component’s resource allocation and utilization behavior.

All memory-system requests with a given PARTID share the resource control settings for that partition.

Because a PARTID is communicated to shared MSCs and interpreted there, PARTIDs should be managed and allocated on a system-wide basis.

Resource partitioning controls might be standard or implementation specific.

Standard control interfaces are architected, but optional. Therefore, an MSC that does not require a standard control interface does not need to implement it. Most MSCs implement few of the standard control interfaces.

An implementation-specific resource control can use a PARTID for unique facilities that either control resources not envisioned by the standard controls or that implement unique control methods that cannot be mapped onto the standard control interfaces.

9.2 Partition resources

An MSC contains resources that affect the performance of the memory system. For such a resource to be partitionable:

- The component must support MPAM at its upstream interface.
- The component must have one or more MPAM resource controls for that resource.

A partitionable resource may be partially allocated to a partition according to the programming of the MPAM resource control or controls for that resource.

If the implementation supports the RIS MPAM feature, the MSC may have two or more partitionable resources differentiated by the value of `MPAMCFG_PART_SEL.RIS`. For more information see [Resource instance selection on page 8-166](#).

9.3 Standard partitioning control interfaces

The MPAM architecture defines standard partitioning control interfaces. This enables binary distribution of operating systems supporting MPAM.

The MPAM architecture defines the following standard types of control interfaces for memory-system resources:

- Cache-portion partitioning.
- Cache maximum-capacity partitioning.
- Cache maximum associativity partitioning.
- Memory-bandwidth portion partitioning.
- Memory-bandwidth minimum and maximum partitioning.
- Memory-bandwidth proportional-stride partitioning.
- Priority partitioning.

Each of these standard control interfaces is optional at each MSC. An MSC may implement several controls or none. Some controls only make sense for certain types of MSCs, or for certain implementations of an MSC. Others may be possible but too costly for the system's target market.

Cache-portion partitioning and memory-bandwidth portion partitioning follow the generic portion-control interface described in *Portion resource controls* on page A-409. Cache maximum-capacity partitioning follows the generic maximum-usage control interface described in *Maximum-usage resource controls* on page A-410.

The presence of each standard control is indicated by a bit in `MPAMF_IDR`, or in a resource-specific memory-mapped ID register. See *Memory-mapped ID register description* on page 11-225.

The control settings storage is accessed through the combination of several access indices:

- The address space used to access the Secure or Non-secure MSC register. Controls for PARTIDs in:
 - The Secure PARTID space are accessed through registers in the Secure address space
 - The Non-secure PARTID space are accessed through registers in the Non-secure address space.
- The MSC that contains the control. This is represented as the base address of the MPAM feature page in the address space. These are represented here as:
 - `MPAMF_BASE_s` in the Secure address space.
 - `MPAMF_BASE_ns` in the Non-secure address space.
- If `MPAMF_IDR.HAS_RIS` is 1, `MPAMCFG_PART_SEL.RIS`. This field selects a resource to access.
- `MPAMCFG_PART_SEL.PARTID`. This field selects the PARTID from:
 - The PARTID space.
 - The resource instance to be configured.
- The control settings register. When accessed, this register selects which control is being configured for:
 - The PARTID.
 - The PARTID space.
 - The resource instance.

For example, to access the memory bandwidth maximum configuration settings for Secure PARTID 15 on resource instance 2 of an MSC that implements RIS:

1. Secure PARTID 15 must be stored in `MPAMCFG_PART_SEL.PARTID` at the address `MPAMF_BASE_s + 0x0100` and, due to RIS being implemented, the RIS field of that address must be set to 2 to ensure access to the correct resource instance.
2. Once the store has completed, the new maximum fraction of memory bandwidth for Secure PARTID 15 of resource instance 2 must be stored into the `MPAMCFG_MBW_MAX_s` register of this MSC, found at `MPAMF_BASE_s + 0x0208`.

Software must ensure mutual exclusion for access to `MPAMCFG_*` registers of each MSC.

9.3.1 Disabling a PARTID

A PARTID can be enabled or disabled with a single store to the MSC. The enabled status of a PARTID within a PARTID space is global to the MSC. It applies to all the other partitioning controls in that MSC.

This functionality allows for the rapid reclaim of resources used by a PARTID if the software using the PARTID is exited or at equipment-wide mode changes.

A disabled PARTID behaves as if it is programmed to allocate no resource or allocate resource only with the lowest allocation priority.

A PARTID is disabled by [MPAMCFG_DIS](#) with the PARTID and an NFU bit. The NFU bit declares that software has no future use of that PARTID. If [MPAMCFG_DIS.NFU](#) is written as 0, hardware must preserve the settings of [MPAMCFG_DIS.PARTID](#) and those settings must immediately be used once the PARTID is enabled at a later time. If [MPAMCFG_DIS.NFU](#) is written as 1, hardware is permitted to either preserve the settings or to discard them and so requiring new settings to be configured before the PARTID is re-enabled.

The PARTID disabled or enabled is in the PARTID space that corresponds to the [MPAMF_BASE](#) page instance used to access the [MPAMCFG_DIS](#) or [MPAMCFG_EN](#) register.

The settings for a disabled PARTID can be accessed to read or write the control settings. See [MPAMCFG_PART_SEL](#) and [Resource controls on page 8-165](#).

If [Resource instance selection on page 8-166](#) is enabled in the MSC, The [MPAMCFG_DIS](#), [MPAMCFG_EN](#) and registers affect the behavior of all resource instances in the PARTID.

Instances of [MPAMCFG_EN](#), [MPAMCFG_DIS](#) and [MPAMCFG_EN_FLAGS](#) exist at fixed offsets in each MPAM feature page. There is an MPAM feature page in each physical address space. These feature pages access the control settings of the PARTID in the PARTID space associated with that address space by using the [MPAMCFG_PART_SEL](#) register instance in the same physical address space.

To assist in enabling or disabling many PARTIDs, [MPAMCFG_EN_FLAGS](#) accesses the enable flags of 32 PARTIDs at once for reading or writing as a bit vector. The block of PARTID enable flags are from [MPAMCFG_PART_SELPARTID_SEL & 0xFFE0](#) in [MPAMCFG_EN_FLAGS\[0\]](#) for 32 PARTIDs to [MPAMCFG_PART_SELPARTID_SEL & 0xFFE0 + 31](#) in [MPAMCFG_EN_FLAGS\[31\]](#).

A PARTID is re-enabled by storing [MPAMCFG_EN](#) with the PARTID to enable.

The enabled status of a PARTID controls the behavior of the request PARTID, even when [PARTID narrowing](#) is implemented.

Enabled and disabled behavior of resource controls

The behavior of an enabled control is the normal behavior of that control with the programmed control settings.

The behavior of a disabled control depends on the type of the control:

- A fractional control is the same as if the control were set to zero.
- A portion-based partitioning control is as if the control were set to allocate no portions.
- In a cache, a disabled PARTID has the second lowest allocation priority. This is higher than the allocation priority of an empty cache line, meaning it is likely to be replaced.
- For resource controls, only the control for PARTID of 0 must be reset. PARTID 0 must be reset to enabled 0b1. Firmware must initialize all PARTIDs in all PARTID spaces to be enabled at system boot before transferring to software that might not support this feature.
- When [PARTID narrowing](#) is implemented, the resource control settings could be shared by multiple request PARTIDs. Therefore, disabling a PARTID cannot make the resource control for a shared internal PARTID act as if it has no resource, Instead it must act as if the request PARTID is temporarily mapped to an internal PARTID that has no resources assigned. This means that [MPAMCFG_DIS.NFU](#) must not be implemented in an MSC that has [PARTID narrowing](#).

9.3.2 Cache-portion partitioning

A portion is a uniquely identifiable part of a resource. It is of fixed size or capacity and all portions of a resource are the same size. A particular resource has a constant number of portions. Every partition that is given access to a portion *n* shares access to portion *n*.

The storage portions of caches can be partitioned. Allocating portions of a cache to a partition permits requests attributed to that partition to allocate within those portions of the cache.

When a request to a cache requires a cache line to be installed in the cache, the PARTID of that request determines which portions of the cache the request may allocate to install the line.

Cache-portion partitioning uses the generic portion-partitioning interface described in [Portion resource controls on page A-409](#).

Cache-portion bit map

A cache-portion bitmap (CPBM) controls the cache-storage portion allocation for a partition. Each bit of a CPBM controls whether the partition is permitted to allocate a particular capacity portion of the cache. The number of capacity portions available in a cache is an IMPLEMENTATION DEFINED parameter that is discoverable in [MPAMF_CPOR_IDR](#) for the cache. The width of the CPBM field is equal to the number of capacity portions available in the cache.

For example, assume a cache has a 1 MB total capacity in 32 portions. Each portion has a capacity of $1 \text{ MB} / 32 = 32 \text{ KB}$. A partition has 4 portions allocated (only 4 bits in the CPBM are 1's). So, this partition can only allocate into these particular 4 portions, allowing up to 128 KB, or 1/8th of the cache's total capacity.

CPBM is an instance of the generic portion bitmap (PBM) described in [Portion resource controls on page A-409](#).

Over-allocation of capacity portions

Storage capacity portions cannot be over-allocated. This is true because the CPBM contains bits that control allocations in the implementation-dependent number of allocable capacity portions of the cache.

Changing CPBM for a partition

Software may change the CPBM during system operation. This does not disrupt normal system operation because the CPBM only affects new allocations and does not reallocate previously allocated cache storage.

If a cache line was allocated under a previous CPBM to a portion that is not set in the new CPBM, the partition is using more of the cache capacity than it is entitled to under the new CPBM:

- If lines previously allocated in a portion that is not in the new CPBM are not accessed again, they will eventually be reallocated to a partition that has its CPBM bit set for that portion of the capacity. So, these will represent a temporary mis-allocation of capacity.
- If however, a line that is present in the cache in a portion that is not in the new CPBM continues to be accessed, this can lead to a long-term mis-allocation of capacity. The line's location optionally might be updated, see [Write hits that update the PARTID of a cache line may move that line to a different portion on page 5-59](#).

Using cache-portion partitioning with cache maximum-capacity partitioning

When cache-portion partitioning is used with cache maximum-capacity partitioning, both controls are effective as described in [Using cache maximum-capacity partitioning with cache-portion partitioning on page 9-190](#).

9.3.3 Cache minimum-capacity resource control (CMIN)

Cache minimum-capacity resource control is a memory bandwidth minimum control that gives priority to a portion of the cache capacity that a PARTID can use. When implemented this control is used in addition to cache maximum capacity.

The [MPAMCFG_CMIN](#) register has the CMIN control setting in 16-bit fixed-point fraction format. A PARTID that currently occupies less than CMIN fraction of the cache capacity has an elevated allocation priority.

The implemented bit width of the CMIN field is described in [MPAMF_CCAP_IDR.CMAX_WD](#). Implemented bits are always bit [15:16-CMAX_WD]. If both [MPAMCFG_CMAX](#) and [MPAMCFG_CMIN](#) are implemented, the implemented most significant fractional bits of both registers are the same, and that width is CMAX_WD.

CMIN and Cache allocation priorities

The partitioning control contributes one level in a cache line allocation priority scheme, as shown in [Table 9-1](#)

Table 9-1 Cache allocation priorities

Cache line occupant	Priority	Description
Unallocated	0 - lowest	Always allocatable
Disabled PARTID	1	Line occupied by disabled PARTID
PARTID with capacity over CMAX	2	Line occupied by PARTID using > CMAX
PARTID between CMAX and CMIN	3	Line occupied by PARTID in midrange
PARTID under CMIN	4	High priority

The request PARTID is evaluated against these criteria and assigned a priority. A request cannot have priority of 0.

The priority values of each line in the set are compared and if there is at least one current cache occupant with lower priority, the request replaces one lowest priority of these.

If there are no lower priority lines, but one or more lines of the same priority, the request can replace one of those according to the following exceptions:

- If the request PARTID is currently using > CMAX of the capacity and has [MPAMCFG_CMAX.SOFTLIM](#) == 0, the request may only replace a line currently occupied by the same PARTID.
- If the *Cache associativity partitioning (CASSOC)* on [page 9-188](#) control is implemented, this may limit the request PARTID to not allocate any new capacity in the associativity unit (cache set) but only to replace one of the request PARTID's previously allocated cache lines.
- Otherwise, the replacement target is chosen from among the lines at the same priority or lower by some other mechanism, presumably the cache replacement algorithm.

If there are no current occupants with the same or lower priority than the request PARTID, then the request does not allocate in the cache.

———— **Note** —————

A request by a PARTID always ties with lines currently occupied by the same PARTID as this priority is determined solely from the PARTID.

Layered filtering of allocation choices

The choice of allocation candidates involves the following steps. They must be performed in order:

1. All implemented MPAM cache partitioning controls are applied:
 - If [MPAMCFG_CPBM<n>](#) is implemented, only candidates that have the [MPAMCFG_CPBM<n>](#) bit set are included.

- If `MPAMCFG_CMAX` is implemented and the PARTID currently occupies greater than CMAX fraction of the cache capacity, the choices are limited to:
 - If `MPAMCFG_CMAX.SOFTLIM` is 0, lines currently occupied by the same PARTID are treated as the set of candidates.
 - If `MPAMCFG_CMAX.SOFTLIM` is 1 specifying Unallocated lines, those occupied by a disabled PARTID and those occupied by the same PARTID are treated as the set of candidates.
 - If *Cache associativity partitioning (CASSOC)* is implemented and the request PARTID currently occupies more than the CASSOC fraction of the associativity in the unit of associativity that the request addresses, the choices are limited to only those lines already occupied by the request PARTID.
2. The CMIN priority of the request is compared to each of the remaining lines and those candidates that are occupied by a PARTID of higher priority than the request are removed as candidates.
 3. If no replacement candidates remain, no line is allocated. If candidates exist, the implementation's cache replacement algorithm, for example LRU, is used to select between the remaining candidates.

9.3.4 Cache associativity partitioning (CASSOC)

Cache associativity partitioning gives direct control over the amount of associativity that the PARTID may use within any unit of associativity. In a set associative cache, the CASSOC control sets the maximum fraction of the ways that a PARTID could allocate within any cache set. In a fully associate cache, it would set the fraction of the entries that the PARTID could use.

The cache maximum associativity control setting for a PARTID is accessed through the `MPAMCFG_CASSOC.CASSOC` field. This field is encoded in the fixed-point fraction format.

Maximum cache associativity usage in fixed-point fraction format by the partition selected by `MPAMCFG_PART_SEL`.

CASSOC sets the maximum fraction of the cache associativity that the PARTID is permitted to allocate. CASSOC regulates the associativity in each associativity grouping of the cache. In a set associative cache, CASSOC applies to the fraction of the ways in each set.

The implemented width of the fixed-point fraction is defined by `MPAMF_CCAP_IDR.CASSOC_WD`.

Unimplemented bits within the `MPAMCFG_CASSOC.CASSOC` field are RAZ/WI. The implemented bits of the CASSOC field are always the most-significant bits of the field.

The fixed-point fraction CASSOC is less than 1. The implied binary point is between bits 15 and 16. This representation has as the largest fraction of the cache that can be represented in an implementation with w implemented bits is $1 - 1/(2^w)$.

As with the other resource controls, the control for PARTID must reset to all 1s, the maximum fraction.

An instance of `MPAMCFG_CASSOC` exists at a fixed offset in each MPAM feature page. There is an MPAM feature page in each physical address space. Accesses the CASSOC control setting for the PARTID in the PARTID space associated with that address space using the `MPAMCFG_PART_SEL` register instance in that same physical address space.

9.3.5 Cache maximum-capacity partitioning

A limit may be set on the storage capacity of a cache that a memory-system partition may use. Setting a maximum cache capacity to a partition permits requests attributed to that partition to allocate up to that maximum cache capacity. Attempts to allocate beyond that capacity must limit a partition's capacity usage.

(informative) Examples of techniques for limiting cache usage by a new request when a partition's capacity usage is at or above its maximum include:

- Do not allocate for the new request.
- Replace some data from that partition with data from the new request.
- Evict some data from that partition from the cache before allocating for the new request.
- Defer the required deallocation until a more convenient time.

Cache lookups are not affected by partitioning. A cache lookup must find a valid cache line even if that line was allocated with a different PARTID.

Cache maximum-capacity partitioning follows the description of the generic maximum-usage resource control interface described in [Maximum-usage resource controls on page A-410](#).

Cache maximum-capacity control setting

The cache maximum-capacity control setting is programmed by storing a capacity limit into the MSC's cache maximum capacity control interface, MPAMCFG_CMAX.

This setting is a hard limit on the cache capacity. To set a soft limit, see [Cache maximum-capacity control soft limit](#).

The cache maximum-capacity limit is a fraction of the cache's total capacity. The format of the limit value is a fixed-point fraction, as described in [About the fixed-point fractional format on page 9-200](#).

For example, to allocate 30% of a 256 KB cache to a partition:

- In the fixed-point fractional format, 1.0 is represented as $2^{16} - 1$, or in hex as 0xFFFF. The subtraction makes 1.0 within the range of the representation.
- So, the representation of 30% would be $1.0 * 0.30$, which in hex is 0xFFFF * (decimal) 0.30, or 0x4CCC.
 - Similarly, 25% would be 0x3FFF; 14% would be 0x23D6; 3% would be 0x07AE; and 3.25% would be 0x0851.
- If you have a cache with 256 KB of capacity, and the resource control setting for a PARTID is set to 0x4CCC to represent 30%, that partition is permitted to use 30% of the cache, or about 76.75 KB of capacity.
- Since most, but not all, Arm caches have 64-byte lines, a 256 KB cache has 4096 of these 64-byte lines, and 30% of those lines is 1228 or 76.75 KB.

The fixed-point fractional format permits an implementation to leave bits to the right as unimplemented, meaning that the value would be truncated to the implemented bits, causing some of the right-most bits to be zeros:

- As an example, the 3% value previously mentioned is 0x07AE. If only 8 bits of fraction are implemented, when software stores 0x07AE into a resource control setting, the value is shortened to the most significant bits and stored as 0x07--.
- When using the resource control setting, the unimplemented bits would be read as zeros.

The actual value of the setting is therefore an interval from the value of the control setting up to the value of the control setting plus one in the right-most implemented bit.

- In the case of the 3% value previously mentioned, that interval is from 0x07 (2.734%) to 0x08 (3.125%).
- An implementation is permitted to regulate the resource to any point within this interval.

Cache maximum-capacity control soft limit

When MPAMF_CCAP_IDR.HAS_CMAX_SOFTLIM is 1, MPAMCFG_CMAX implements the SOFTLIM field.

When MPAMCFG_CMAX.SOFTLIM is 0, the cache maximum capacity capacity control sets a hard limit that prevents the PARTID from allocating more than the maximum fraction of the cache capacity.

When a PARTID's request requires allocation in the cache but the PARTID's cache capacity usage is above the fraction of the cache capacity set by its MPAMCFG_CMAX register, its capacity use cannot be increased even if there is unused capacity.

Setting the CMAX control for a PARTID to be set to a soft limit allows unused capacity to be temporarily used. The control bit MPAMCFG_CMAX.SOFTLIM controls this behavior. When SOFTLIM is 1, a PARTID that is currently using more than its MPAMCFG_CMAX.CMAX capacity is permitted to allocate more capacity from an Unallocated line or a line that is in use by a disabled PARTID.

MPAMCFG_CMAX.SOFTLIM for PARTID 0 must reset to 0, hard limit behavior. For compatibility with software that does not support SOFTLIM, the firmware must reset SOFTLIM to 0 for all PARTIDs in all PARTID spaces before transferring to software that might not support SOFTLIM.

Using cache maximum-capacity partitioning with cache-portion partitioning

When cache-portion partitioning is used with cache maximum-capacity partitioning, both controls are effective. Cache-portion partitioning controls which portions of the capacity may be allocated to this partition. Cache maximum-capacity partitioning limits the amount to less than or equal to a cache-capacity limit control setting.

For example, assume several portions of the capacity are shared by several partitions. Any such partition can allocate within the shared portions. To keep one of the partitions from using too much of the shared allocation, the maximum-capacity controls for the partitions can each be set to less than the capacity of the portions to which they may allocate. If each partition is given 50% of the capacity of the shared portions, then no one partition can use more than 50% of the shared cache portions.

Here is an example of a cache with 1 MB total capacity in 32 portions. Each partition has 4 portions for shared allocation. To allow a partition to use no more than 50% of its shared allocation, you would set the cache maximum-capacity limit for this partition as follows:

1. Portions divide the capacity of the cache into distinct parts of the same size. So, for a 1 MB cache divided into 32 portions, each portion has $1 \text{ MB} / 32 = 32 \text{ KB}$:
 - a. In portion partitioning, it is not possible to allocate anything other than an integral number of portions to a PARTID.
 - b. A cache portion may be exclusively allocated to a PARTID or it may be shared by 2 or more PARTIDs.
 - c. A PARTID that has 4 portions allocated to it is permitted to use $32 \text{ KB} * 4 = 128 \text{ KB}$.
2. The combined behavior of cache-portion partitioning and cache maximum-capacity control has both controls:
 - a. To allow a PARTID to use only 50% of the storage in the portions allocated to it, the cache maximum-capacity control is used.
 - b. Compute the fraction of the cache that is 50% of the storage in the portions allocated. In this case, it is $64 \text{ KB} / 1 \text{ MB} = 1/16$ or 6.25%, which is 0x0FFF in the fixed-point fractional representation.
 - c. The combined behavior only permits the PARTID to allocate storage in the 4 portions it may use according to the cache-portion control, but its use of storage is also limited to 50% of the storage of those portions.

Over-allocation of capacity

Cache capacity can be over-allocated because the sum of the cache-capacity control parameters may exceed 100% of the cache size. This may be acceptable. The cache-capacity control does not provide a minimum cache capacity guarantee, only a maximum guarantee. The data of inactive partitions may be evicted from the cache due to the activity of other partitions.

9.3.6 Memory-bandwidth portion partitioning

An MSC's downstream bandwidth may be divided into portions, and those portions may be allocated to partitions.

Memory-bandwidth portion partitioning follows the generic portion-control interface described in [Portion resource controls on page A-409](#), in which a portion is a quantum of bandwidth. A Time-Division Multiplexing (TDM) scheme that allocates traffic to time slots is an example of a bandwidth allocation system that has portions.

The BandWidth Portion Bit Map (BWPBM) is the Portion Bit Map (PBM) for bandwidth.

9.3.7 Memory-bandwidth minimum and maximum partitioning

An MSC's downstream bandwidth may be partitioned by bandwidth usage. There are two bandwidth-usage control schemes. An MSC can optionally implement each of them:

- Minimum bandwidth to which the PARTID has claim, even in the presence of contention.
- Maximum bandwidth limit available to the PARTID, in the presence of contention.

The minimum and maximum bandwidth partitioning schemes rely on tracking bandwidth usage by PARTIDs. Because bandwidth is measured in bytes per second, bandwidth measurements have a dependence on time. That dependence is captured in this specification as the accounting window or accounting period. See [Memory-bandwidth allocation accounting window width on page 9-192](#)

Without contention, the bandwidth may be strictly limited to the maximum or permitted to use more than the maximum, since no other partition's traffic is claiming that bandwidth.

Any combination of these control schemes may be used simultaneously in an MSC that supports them.

Each control scheme is described below.

Minimum-bandwidth limit partitioning

The minimum-bandwidth control scheme regulates the bandwidth used by a PARTID's requests:

- If the bandwidth usage by the PARTID of the request, as tracked during the accounting period, is currently less than the partition's minimum, its requests are preferentially selected to use downstream bandwidth.
- If the bandwidth usage by the PARTID of the request, as tracked during the accounting period, is currently greater than or equal to the PARTID's minimum, its requests compete with other requests as described under [Maximum-bandwidth limit partitioning](#), if implemented. If maximum-bandwidth limit partitioning is not implemented, requests with PARTID that have current bandwidth usage greater than that PARTID's minimum-bandwidth limit compete with all requests and do not receive preferential treatment under the minimum-bandwidth limit.

A PARTID's requests below its minimum bandwidth are therefore most likely to be scheduled to use downstream bandwidth.

Bandwidth that is not used by a partition during an accounting window does not accumulate.

The control parameter is a fixed-point fraction of the available bandwidth. For more information, see [About the fixed-point fractional format on page 9-200](#).

Maximum-bandwidth limit partitioning

The maximum-bandwidth limit control scheme regulates the bandwidth used by a PARTID's requests:

- If the bandwidth usage by the PARTID as tracked during the accounting period is currently less than the PARTID's maximum bandwidth but greater than or equal to its minimum bandwidth, if implemented, its requests are selected to use bandwidth when there are no competing minimum bandwidth requests to service. Requests for PARTIDs that are above their minimum-bandwidth limits but less than their maximum-bandwidth limits compete with each other to use bandwidth.
- If the bandwidth usage by the PARTID of the request is greater than or equal to the PARTID's maximum bandwidth and the HARDLIM bit is not set, the request competes with other such requests to use bandwidth when there are no competing requests to service for PARTIDs currently below their minimum bandwidth or maximum bandwidth.
- If the bandwidth usage by the PARTID of the request is greater than or equal to the PARTID's maximum bandwidth and the Hard Limit (HARDLIM) bit is set, the requests are saved until the PARTID's bandwidth usage drops below its maximum bandwidth control setting.

If the HARDLIM bit is set, the partition is prevented from using more bandwidth if the current bandwidth usage is over the maximum bandwidth limit. As the accounting window advances, the current bandwidth usage resets to zero or otherwise decays, permitting the partition to again use bandwidth.

Bandwidth that is not used by a partition during an accounting window does not accumulate.

The control parameter is a fixed-point fraction of the available bandwidth. For more information, see [About the fixed-point fractional format on page 9-200](#).

Using minimum-bandwidth limit with maximum-bandwidth limit controls

If both minimum-bandwidth limit and maximum-bandwidth limit are implemented, [Table 9-2](#) shows the preference of requests.

Table 9-2 Preference of requests for bandwidth limits

If used bandwidth is		The preference is	Description
Below the minimum		High	Only other High requests delay this request ^a .
Above the minimum	Below the maximum limit.	Medium	High requests are serviced first, then compete with other Medium requests ^a .
	Above the maximum limit, with HARDLIM clear.	Low	Requests are not serviced if any High or Medium requests are available ^a .
	Above the maximum limit, with HARDLIM set.	None	Requests are not serviced.

- a. Implementations may occasionally deviate from preference order in servicing requests to meet other goals, such as starvation avoidance.

Bandwidth control parameters

The control parameters for bandwidth partitioning schemes are all expressed in a fixed-point fraction of the available bandwidth. See [About the fixed-point fractional format on page 9-200](#).

[MPAMCFG_MBW_MAX](#), the bandwidth control setting register for maximum-bandwidth limit also includes a Hard Limit (HARDLIM) bit that prevents a partition from using more than the maximum fraction of the available bandwidth that is set in that register.

Memory-bandwidth allocation accounting window width

For both the minimum- and maximum-bandwidth partitioning schemes, memory-bandwidth regulation occurs over an accounting window. The accounting may be either a moving window or by resetting bandwidth counts at the beginning of each accounting-window period.

The width of the window is discoverable and can be read from [MPAMCFG_MBW_WINWD](#) for the PARTID selected by [MPAMCFG_PART_SEL](#).

In implementations that support settable window width per PARTID, [MPAMCFG_MBW_WINWD](#) can be written with a fixed-point format (as described in the register's description) specifying the accounting window width in microseconds.

Fixed accounting window

In fixed-window accounting, bandwidth is apportioned to requests so that each partition gets bandwidth according to the minimum and maximum for that partition ([Over-allocation of minimum bandwidth on page 9-193](#)). Request or local priorities ([Priority partitioning on page 9-194](#)) are used to resolve conflicting requests of the same preference.

When the accounting window's period is reached, a new window begins with no history except for any queue of requests that have not been previously serviced. The new window starts accumulating bandwidth for a partition from zero.

Moving-window accounting

A moving window tracks partition bandwidth usage by all commands issued in the past window width. There is never a reset of the accounting of bandwidth usage per partition. Instead, bandwidth is added to the accounting when a command is processed and removed from the accounting when that command moves out of the window's history. This continuous accounting is relatively free from boundary effects.

Moving-window accounting requires hardware to track the history of commands within the window, in addition to the bandwidth counters per PARTID required by the fixed window.

Other accounting window schemes

An implementation may use another scheme for maintaining history that is broadly in line with the schemes described here. For example, the current bandwidth might decay at a fixed rate proportional to the bandwidth allocation, but not below a current bandwidth of zero.

Over-allocation of minimum bandwidth

The minimum bandwidth allocations of all partitions may sum to more bandwidth than is available. This is not a problem when some partitions are not using their bandwidth allocations, because unused allocations are available for other partitions to use. However, when minimum bandwidth is over-allocated, the minimum bandwidth that is programmed for partitions cannot always be met.

If the programmed minimum bandwidth allocation is to be reliably delivered by the system, software must ensure that minimum bandwidth is not over-allocated.

Over-allocation of maximum bandwidth

The maximum bandwidth allocations of all partitions may sum to more bandwidth than is available. This is not a problem when some partitions are not using their maximum bandwidth allocations, because unused allocations are available for other partitions to use. If maximum bandwidth is over-allocated, the maximum bandwidth that is programmed for partitions cannot always be met.

Available bandwidth

The bandwidth available downstream from an MSC is not constant, and it affects the operation of minimum and maximum bandwidth partitioning.

Available bandwidth may depend on one or more clock frequencies in many systems (for example, DDR clock). Software may require to reallocate bandwidths when changing clock frequencies that affect available bandwidth. Lowering clock rates without changing allocations may result in over-allocation of bandwidth.

The available bandwidth on a DRAM channel varies with the mix of reads and writes and the bank-hit rate. Bandwidth may also vary with burst size.

9.3.8 Memory-bandwidth proportional-stride partitioning

Proportional-stride bandwidth partitioning control is an instance of proportional resource-allocation generic control, described in [Proportional resource allocation facilities on page A-411](#). The control parameter for bandwidth proportional-stride partitioning is expressed as an unsigned integer.

Regulation according to this scheme permits the partition to consume bandwidth in proportion to its stride, in relation to other requests' strides that are contending for bandwidth. See [Model of stride-based memory bandwidth scheduling on page A-411](#) for an example of stride-based proportional bandwidth regulation.

The MPAMF_MBW_IDR.HAS_PROP bit indicates the presence of a memory-bandwidth proportional-stride partitioning control interface in the MSC.

Combining memory-bandwidth proportional stride with other memory-bandwidth partitioning

There is no setting of the STRIDEM1 control field that disables the effects of proportional-stride partitioning on a partition's bandwidth usage. To enable proportional-stride partitioning for a PARTID, `MPAMCFG_MBW_PROP.EN` must be set to 1.

When multiple partitioning controls are active, each affects the partition's bandwidth usage. However, some combinations of controls may not make sense, because the regulation of that pair of controls cannot be made to work in concert.

Memory-bandwidth maximum partitioning must work together with proportional-stride partitioning.

9.3.9 Priority partitioning

Unlike the other memory-system resources in this architecture, priority does not directly affect the allocation of memory-system resources. Instead, it has an effect on conflicts that arise during access to resources. A properly configured system should rarely have substantial performance effects due to prioritization, but priority does play an important role in oversubscribed situations, whether instantaneous or sustained. Therefore, we choose to include priority partitioning here as a tool to aid in isolating memory-system effects between partitions.

A PARTID may be assigned priorities for each component in the memory system that implements a priority partitioning control. This partitioning control allows different parts of the memory system to handle requests with different priorities. For example, requests from a PE to system cache may be set to have a higher transport priority than those from system cache to main memory.

In a system in which the interconnect carries QoS values or priorities, requests arriving at an MSC have an upstream priority as part of the request. In the absence of an internal priority partitioning control, request priority could be used by an MSC to prioritize internal operations. In the absence of a downstream priority partitioning control, the request priority is used as through priority. See *Through priorities*.

Priority partitioning can override the upstream priority with two types of priorities:

- Internal priorities control priorities used in the internal operation of an MSC.
- Downstream priorities control priorities communicated downstream (for example to an interconnect).

“Downstream” refers to the communication direction for requests. “Upstream” refers to the response, and it usually uses the same transport priority as the request that generated it.

Internal priorities

Internal priorities are used within an MSC to prioritize internal operations. For example, a memory controller may use an internal priority to choose between waiting requests when bandwidth allocation indicates two or more requests have the same bandwidth preference.

Internal priority partitioning is optional even if downstream priority partitioning is implemented.

Downstream priorities

An MSC uses a downstream priority to set transport priorities for downstream requests generated during the servicing of an incoming request from upstream.

Downstream priority partitioning is optional even if internal priority partitioning is implemented.

Through priorities

For a system in which the interconnect carries QoS values or priorities, these priorities arrive with incoming requests from upstream. An MSC that does not implement priority partitioning, or that does not implement downstream priority partitioning, must use these upstream priorities on all downstream communication.

If an MSC does not implement priority partitioning, or it does not implement downstream priorities, the downstream priority is always the same as the request (upstream) priority.

The priority of a response through an MSC (from downstream to upstream) is always the same priority as the response received (from downstream). Priority partitioning never alters response priorities received from downstream.

9.4 Vendor or implementation-specific partitioning control interfaces

MPAM provides discoverable vendor extensions to permit partners to invent partitioning controls. These include controls that do not fit the standard interfaces and controls for types of resources not supported through the standard controls defined in this document. Such controls provide product differentiation to address market-segment needs or to provide superior memory-system control.

The `MPAMF_IDR.HAS_IMPL_IDR` bit indicates the presence of `MPAMF_IMPL_IDR` and of implementation-specific or vendor-specific resource partitioning controls.

Vendor, design, or model and version information is present in `MPAMF_IIDR`. `MPAMF_IMPL_IDR` is available for implementations that need to convey additional information about parameters of implementation-specific partitioning controls.

In MPAM v0.1 and from MPAM v1.1:

- If `MPAMF_IMPL_IDR` describes no IMPLEMENTATION DEFINED partitioning controls, `MPAMF_IDR.NO_IMPL_PART` must be 1.
- If `MPAMF_IMPL_IDR` describes no IMPLEMENTATION DEFINED monitors, `MPAMF_IDR.NO_IMPL_MSMON` must be 1.

9.5 Measurements for controlling resource usage

This section is *informative*.

In many cases, resource usage by a partition must be measured so that the resource controller can regulate allocation of the resource to that partition.

In a memory channel, the bytes delivered to requests from a PARTID might be more costly if delivered in response to a series of 1-byte requests rather than cache-line-sized bursts. So, it might be reasonable to count the cost of servicing a 1-byte request to be the same as the cost of servicing a cache-line request rather than as a fraction of a word access cost.

9.6 PARTID narrowing

An implementation may optionally map input PARTID spaces into smaller internal PARTID spaces. This involves mapping the PARTID from a request (reqPARTID) into an internal PARTID (intPARTID). The reqPARTID-to-intPARTID mappings for Secure and Non-secure physical PARTID spaces must be used internally and not for downstream requests.

This mapping is supported by a memory-mapped register, [MPAMCFG_INTPARTID](#), and an ID register bit for each of the Secure and Non-secure physical PARTID spaces. The related behavior includes:

- Translate the incoming request's reqPARTID and MPAM_NS into an intPARTID (with the same MPAM_NS) before accessing the control settings and regulation state of the partition.
- Use [MPAMCFG_INTPARTID](#) to store an association of a reqPARTID in [MPAMCFG_PART_SEL](#) to the intPARTID stored in [MPAMCFG_INTPARTID](#).
- Error code for [MPAMF_ESR](#) to indicate a bad intPARTID mapping for the reqPARTID.
- A bit in [MPAMCFG_PART_SEL](#) indicates that the value in that register is an intPARTID. The register can hold either an intPARTID or reqPARTID at any time, but the reqPARTID can only be used for accessing the association by means of [MPAMCFG_INTPARTID](#). So, at the time [MPAMCFG_INTPARTID](#) is read or written, [MPAMCFG_PART_SEL.INTERNAL](#) must be clear. For access to read or write other control settings registers, the INTERNAL bit must be set.
- With PARTID narrowing implemented, the contents of [MPAMCFG_PART_SEL](#) are interpreted as an intPARTID for accessing control settings through an MPAMCFG_* register other than [MPAMCFG_INTPARTID](#). The [MPAMCFG_PART_SEL.INTERNAL](#) bit must be set to confirm the intPARTID is being used.
- With PARTID narrowing not implemented, the contents of [MPAMCFG_PART_SEL](#) are interpreted as a reqPARTID. The [MPAMCFG_PART_SEL.INTERNAL](#) bit must == 0 to confirm that the reqPARTID is being used.

9.7 System reset of MPAM controls in MSCs

This section is *normative*.

After a system reset, the MPAM controls in MSCs must reset the settings for default PARTID ([Default PARTID on page 3-40](#)) so that software can use all of the resource. Since MPAM_n_ELx.MPAMEN for the highest implemented ELx is reset to 0 by a system reset, the MPAM fields of all requests issued by a PE use the corresponding default PARTID in the PE's current Security state. Only the resource controls for the default PARTIDs must be reset to full access for the system to behave as if there were no MPAM.

Only the control settings for the default PARTID must be reset. The reset value should be appropriate to allow the default PARTID to access all of the resource. This is needed to allow the system to boot up to a point where MPAM resource controls can be set before non-default PARTIDs are used to make requests.

9.7.1 Suggested reset values for standard control types

[Table 9-3](#) shows the suggested reset values for PARTID == 0 control setting for both MPAM_NS == 0 and MPAM_NS == 1.

Table 9-3 Suggested reset values for standard control types

Control type	Reset value
MPAMCFG_CPBM<n>	All ones
MPAMCFG_CMAX	0xFFFF
MPAMCFG_MBW_PBM<n>	All ones
MPAMCFG_MBW_MAX	0xFFFF
MPAMCFG_MBW_PROP	EN=0

In addition, for PARTID narrowing, Arm suggests that reqPARTID == 0 map to intPARTID == 0 and that the reset values be applied to the settings of intPARTID == 0 in both values of MPAM_NS.

9.8 About the fixed-point fractional format

This section is *normative*.

Fractional control parameters use a 16-bit fixed-point format. The format permits implementations to have fewer than 16 bits by truncating least significant bits from the fraction and implementing these bits as RAZ/WI.

Software can be expected to calculate a 16-bit fractional part to store into the memory-mapped register without the need to understand the implemented width of the field. If the field width is less than 16 bits, the least significant bits are silently IGNORED by the implementation. This results in an uncertainty of the intended value.

If software stores an intended fractional value into a field with an implemented width of w , the implementation's truncated field sees a value of v . The value v is at the bottom of the range of v to $v + 2^{-w} - 2^{-17}$ and the intended fractional value lies somewhere within that range, inclusive of the end points.

Depending on the use of the fractional value, the best choice of value within the range could be the center of the range, the smallest end of the range, or the greatest end of the range. For examples, a cache maximum-capacity fraction might best be interpreted as the highest end of the range, and a cache minimum-capacity fraction might best be interpreted as the lowest end of the range.

Table 9-4 shows the fraction widths and hex representation used for three formats. The values in the table are suitable for a maximum limit because the Max value for every entry is never greater than the target value.

Table 9-4 Fraction Widths and Hex Representation

Percentage	16 bits			12 bits			8 bits		
	Hex	Min	Max	Hex	Min	Max	Hex	Min	Max
1.00%	028E	0.9979%	0.9995%	027	0.9521%	0.9766%	01	0.3906%	0.7813%
12.50%	1FFF	12.4985%	12.5000%	1FF	12.4756%	12.5000%	1F	12.1094%	12.5000%
16.67%	2AAB	16.6672%	16.6687%	2A9	16.6260%	16.6504%	29	16.0156%	16.4063%
25%	3FFF	24.9985%	25.0000%	3FF	24.9756%	25.0000%	3F	24.6094%	25.0000%
33.33%	5552	33.3282%	33.3298%	554	33.3008%	33.3252%	54	32.8125%	33.2031%
35%	5998	34.9976%	34.9991%	598	34.9609%	34.9854%	58	34.3750%	34.7656%
37.25%	5F5B	37.2482%	37.2498%	5F4	37.2070%	37.2314%	5E	36.7188%	37.1094%
42.50%	6CCB	42.4973%	42.4988%	6CB	42.4561%	42.4805%	6B	41.7969%	42.1875%
45%	7332	44.9982%	44.9997%	732	44.9707%	44.9951%	72	44.5313%	44.9219%
50%	7FFF	49.9985%	50.0000%	7FF	49.9756%	50.0000%	7F	49.6094%	50.0000%
52%	851D	51.9974%	51.9989%	850	51.9531%	51.9775%	84	51.5625%	51.9531%
55%	8CCB	54.9973%	54.9988%	8CB	54.9561%	54.9805%	8B	54.2969%	54.6875%
58%	9479	57.9971%	57.9987%	946	57.9590%	57.9834%	93	57.4219%	57.8125%
62.75%	A0A2	62.7472%	62.7487%	A09	62.7197%	62.7441%	9F	62.1094%	62.5000%
66.67%	AAA9	66.6641%	66.6656%	AA9	66.6260%	66.6504%	A9	66.0156%	66.4063%
75%	BFFF	74.9985%	75.0000%	BFF	74.9756%	75.0000%	BF	74.6094%	75.0000%
82.50%	D332	82.4982%	82.4997%	D32	82.4707%	82.4951%	D2	82.0313%	82.4219%
88%	E146	87.9974%	87.9990%	E13	87.9639%	87.9883%	E0	87.5000%	87.8906%
95%	F332	94.9982%	94.9997%	F32	94.9707%	94.9951%	F2	94.5313%	94.9219%

Table 9-4 Fraction Widths and Hex Representation (continued)

Percentage	16 bits			12 bits			8 bits		
	Hex	Min	Max	Hex	Min	Max	Hex	Min	Max
100%	FFFF	99.9985%	100.0000%	FFF	99.9756%	100.0000%	FF	99.6094%	100.0000%
2^n	65536			4096			256		
ndigits	4			3			2		
shift	0			0			0		

Chapter 10

Resource Monitors

This chapter contains the following sections:

- *Introduction* on page 10-204.
- *MPAM resource monitors* on page 10-205.
- *Common features* on page 10-208.
- *Monitor configuration* on page 10-211.
- *Monitor behavior on overflow* on page 10-212.

10.1 Introduction

Software environments may be labeled as belonging to a Performance Monitoring Group (PMG) within a partition. The PARTID and PMG can be used to filter some performance events so that the performance of a particular PARTID and PMG can be monitored.

10.2 MPAM resource monitors

MPAM resource monitors provide software with measurements of the resource-type usage that can be partitioned by MPAM. There are two types of MPAM resource monitors:

- [Memory-bandwidth usage monitors](#)
- [Cache-storage usage monitors on page 10-207](#)

Each type of monitor measures the usage by memory-system transactions of a PARTID and PMG. An MSC may implement any number of performance monitor instances, up to 2^{16} of each type. The PARTID for filtering resource monitors is always a request PARTID, even when PARTID narrowing is implemented.

To access a monitor instance, the instance number is stored into the `MSMON_CFG_MON_SEL.MON_SEL` field. All of the monitor access registers for a type of monitor then access that instance of that type. See [Monitor configuration on page 10-211](#).

10.2.1 Memory-bandwidth usage monitors

A memory-bandwidth usage monitor counts payload bytes meeting the filter criteria that pass the monitoring point in the downstream direction for writes or the upstream direction for reads. Each monitor has the following set of memory-mapped configuration registers and functional features:

- A control register `MSMON_CFG_MBWU_CTL` that configures behavior of the monitor instance.
- A filter register `MSMON_CFG_MBWU_FLT` that specifies the transfers to be counted. This register has fields for reads, writes, PARTID, PMG, and other criteria.
- A monitor register `MSMON_MBWU` that contains an optionally scaled count of bytes transferred downstream from this MSC that match the conditions of the filter register. This monitor register may be reset after each capture event. If scaling is enabled, the value read from `MSMON_MBWU` must be shifted left by `MPAMF_MBWUMON_IDR.SCALE` bit positions to scale the value to the number of bytes.
- In MPAM v0.1 and from MPAM v1.1, an optional long monitor register, `MSMON_MBWU_L`, that contains a count of 44 bits or 63 bits. A NRDY bit is also present in this register, see [Not-ready Bit on page 10-209](#).
- An optional capture register `MSMON_MBWU_CAPTURE` that is loaded from the monitor register each time the selected capture event occurs. When a capture event occurs, the monitor register is copied to the capture register and the monitor register is optionally reset to zero.
- In MPAM v0.1 and from MPAM v1.1, if `MPAMF_MBWUMON_IDR.{HAS_LONG, HAS_CAPTURE}` are 1, the `MSMON_MBWU_L_CAPTURE` register must be implemented.
- A Not-Ready (NRDY) bit ([Not-ready Bit on page 10-209](#)) in the memory-bandwidth usage register `MSMON_MBWU` is set when the filter register or the control register is written. The NRDY bit is reset to 0 after a capture event. The NRDY bit is copied to the capture register along with the rest of the monitor register's content. This copy is made before the NRDY bit is reset. If the value of the NRDY bit in the capture register is 1, the captured resource usage should be viewed as representing an incomplete sampling interval. Therefore, the count should be assumed to be incorrect.

A capture event is needed if the optional capture register is implemented. The capture event causes the transfer of each monitor's count register to its capture register and may optionally reset the count register.

If the count register is reset by a capture event, this allows reading the bytes transferred that meet the criteria set in the filter and control registers:

- During the interval between the last two capture events from `MSMON_MBWU_CAPTURE`.
- Since the last capture event from `MSMON_MBWU`.

Bandwidth usage can be computed in software from the count of bytes transferred as read from `MSMON_MBWU` or `MSMON_MBWU_CAPTURE` and the interval over which the count was collected.

There can be several sources of the capture event. The capture event source to use is specified in `MSMON_CFG_MBWU_CTL.CAPT_EVNT` (*Memory-mapped monitoring configuration registers on page 11-311*). It can be advantageous to use a single event to capture monitors in several MSCs simultaneously. A periodic capture event for multiple MSCs could be generated at the system level, perhaps using a generic timer, and distributed to the MSCs.

The source of an external capture event is selected in `MSMON_CFG_MBWU_CTL.CAPT_EVNT`. A local capture event generator is present if `MPAMF_MSMON_IDR.HAS_LOCAL_CAPT_EVNT == 1`, and this generator generates events when certain values are written into `MSMON_CAPT_EVNT`.

If `MSMON_CFG_MBWU_CTL.OFLOW_LNKG` is implemented, a monitor instance with an `OFLOW_LNKG` value that is not zero can signal the capture event number in that field when the monitor instance overflows. See *Control of signaling to other monitor instances on page 10-212*.

Scaled MBWU count value

If `MSMON_CFG_MBWU_CTL.SCLEN == 0`, the count is not scaled. If `MSMON_CFG_MBWU_CTL.SCLEN == 1`, the count in `MSMON_MBWU` is a scaled count.

The scaled count in `MSMON_MBWU` is the true count of bytes transferred, rounded to 2^{SCALE} and then shifted right by `SCALE` bit positions. The shift count, `SCALE`, is `MPAMF_MBWUMON_IDR.SCALE`.

`SCALE` is an implementation constant chosen for a monitoring point such that periodic sampling and reset of `MSMON_MBWU_CAPTURE` can count the highest traffic rates possible at the monitoring point without overflowing the `VALUE` field at a maximum sampling rate. The sampling rate is limited by the target use.

For example, if the maximum traffic that could pass the monitoring point is 300 GBps and the system environment supports capturing the counter 30 times per second, the counter must be scaled to no more than $2^{31} - 1$ counts per thirtieth of a second. This requires scaling the counter by a factor of at least 5, so the `SCALE` must be at least 3.

If the traffic to memory might be distributed across several MSCs (for example, across several memory channel controllers), a comprehensive measurement of bandwidth might require reading multiple memory-bandwidth usage monitors on those MSCs and summing the results. Capturing those monitors with the same system-level capture event allows correlated monitor values.

Long MBWU counter and capture

In MPAM v0.1 and from MPAM v1.0, there is optional support for 44-bit or 63-bit MBWU counters.

`MSMON_MBWU_L` is optional and only present when `MPAMF_MBWUMON_IDR.HAS_LONG` is 1. This indicates that this monitor type supports long counters.

If `MPAMF_MBWUMON_IDR.HAS_LONG` and `MPAMF_MBWUMON_IDR.HAS_CAPTURE` are 1, the `MSMON_MBWU_L_CAPTURE` register must also be implemented.

The `VALUE` field of the long registers is never scaled.

The `VALUE` field of `MSMON_MBWU_L` and `MSMON_MBWU_L_CAPTURE` can be implemented either as a 63-bit `VALUE` field or a 44-bit `VALUE` field. The 44-bit `VALUE` field is indicated when `MPAMF_MBWUMON_IDR.LWD` is 0 and has bits[62:44] of each register as `RES0`. When `MPAMF_MBWUMON_IDR.LWD` is 1, the `VALUE` field of each register is 63 bits.

An overflow occurs in the long counter when the count in the `VALUE` field exceeds the maximum representable value. This depends on the length of the `VALUE` field. In `MSMON_MBWU`, the `VALUE` field is always 31 bits. If `MSMON_MBWU_L` is implemented, the length of the `VALUE` field is either 63 or 44 bits as set by `MPAMF_MBWUMON_IDR.LWD`.

When any instance of the `MSMON_MBWU_L` counter overflows, the `MSMON_CFG_MBWU_CTL.OFLOW_STATUS_L` bit is 1. If `MSMON_CFG_MBWU_CTL.OFLOW_INTR_L` is set, this overflow produces an MPAM Overflow interrupt. See *MPAM overflow interrupt on page 8-176* and *Control of monitor behavior on overflow on page 10-212*

When an implementation has both the long counter and the short 31-bit counter, the short counter might overflow when the long counter has not overflowed and produce an MPAM Overflow interrupt. This can be prevented by setting `MSMON_CFG_MBWU_CTL.OFLOW_INTR` to 0, which disables the overflow interrupt for overflow of the short counter.

The `MSMON_CFG_MBWU_CTL.OFLOW_FRZ` field is not duplicated, and affects the behaviors of both short and long counters on overflow.

10.2.2 Cache-storage usage monitors

A cache-storage usage monitor is filtered by a PARTID and PMG. Each monitor has the following memory-mapped configuration registers:

- A filter register `MSMON_CFG_CSU_FLT` that sets the PARTID and PMG to be monitored.
- A cache-storage usage register `MSMON_CSU` that reports the amount of storage currently present within the cache allocated by the PARTID and PMG. It is an implementation choice whether `MSMON_CSU` is implemented as RO or RW.
- A Not-Ready bit in the cache-storage usage register `MSMON_CSU` that indicates that the value is not accurate. An implementation may set this NRDY bit if the value in the cache-storage usage register is not currently accurate, possibly because it is still being computed. For more information on the Not-Ready bit, see *Not-ready Bit on page 10-209*.
- An optional capture register `MSMON_CSU_CAPTURE` that is loaded from the cache-storage usage register each time the capture event occurs.

A capture event is needed if the optional capture register is implemented. The capture event causes the transfer of each monitor's cache-storage usage register to its optional capture register.

The source of an external capture event is not specified here. It can be advantageous to use a single event to capture monitors in several MSCs simultaneously. A periodic capture event for multiple MSCs could be generated at the system level, perhaps using a generic timer, and distributed to the several MSCs.

The source of an external capture event is selected in `MSMON_CFG_CSU_CTL.CAPT_EVNT`. A local capture event generator is present if `MPAMF_MSMON_IDR.HAS_LOCAL_CAPT_EVNT == 1`, and this generator generates events when certain values are written into `MSMON_CAPT_EVNT`.

If a monitor needs time to become accurate, the NRDY bit signals that the value is not yet accurate. Some methods of building cache-storage usage monitors might involve (1) a phase in which the monitor collects enough information to begin accurately tracking usage, or (2) a phase in which the measurement is kept accurate by tracking resource usage events. For example such a monitor might take tens of microseconds to complete the first phase before the value accurately tracks the actual resource usage. In this case, the NRDY bit would be kept at 1 until the monitor value becomes accurate.

The NRDY bit is included because some implementations may have timing restrictions between setting the filter register and reading the cache-storage usage register that may span thousands of PE cycles. Reading the monitor too soon is permitted to affect the accuracy of the readout, and it is indicated when the NRDY bit of the cache-storage usage register is 1.

The cache storage usage monitor architecture supports overflow behavior in CSU monitors. However, Arm recommends that CSU monitors be designed so that overflow is not possible.

10.3 Common features

All MPAM performance monitors have these features:

- Monitor register.
- Not-ready bit.
- Capture register.
- Overflow bit.
- Enable bit.

These features are described below.

10.3.1 Monitor register

Every monitor instance has a monitor register that contains the VALUE field and the NRDY field. The VALUE field contains the current count or measurement value of the monitor.

When the monitor is enabled, the VALUE field can change at any time. If this monitor counts events, such as the memory bandwidth usage monitor counts bytes passing a monitoring point, the count increases as monitored events occur that match the filter criteria. If this monitor measures some value, such as a cache storage usage monitor measures the bytes in cache lines of a cache, the measurement can move up and down as the resource usage matching the filter criteria changes.

The events counted or the resources measured by a monitor instance depend upon the configuration of the monitor instance's configuration and filter registers. If either of these are changed, the VALUE field continues counting or measuring with the new criteria without automatically resetting VALUE to 0.

A counting monitor register can be set by software to any value by storing the new value to the register. Counting monitors continue counting the monitored event from this new value.

A write to a monitor register sets the NRDY and VALUE fields to the data written. The monitor register can be written at any time.

When `MSMON_CFG_<type>_CTL.EN` is 1, the monitor is Enabled to count events or measure resource usage matching the configuration in `MSMON_CFG_<type>_CTL` and `MSMON_CFG_<type>_FLT`. An Enabled monitor automatically updates as matching events occur or matching resource usage changes.

When `MSMON_CFG_<type>_CTL.EN` is 0, the monitor is Disabled. A Disabled monitor must not change automatically, but may be written by software.

A monitor overflows when the VALUE field exceeds its largest representable value. After an overflow, the VALUE field wraps around by dropping the high-order bit. The resulting truncated value may be zero or greater, depending on the increment for a counter or the value for a measurement.

When an overflow occurs, the overflow behaviors selected in `MSMON_CFG_<type>_CTL` are performed automatically. These independently-selectable behaviors are:

- Freezing the VALUE field or continuing to count or measure.
- Signaling an MPAM overflow interrupt from the MSC.
- Capturing the overflowed VALUE field in the monitor instance's capture register and optionally resetting the monitor's VALUE and NRDY fields to zeros.
- Signaling a capture event to other monitor instances that are programmed to be sensitive to that capture event or different types of and for the same or different RIS numbers.

When an overflow occurs, the overflow status bit in `MSMON_CFG_<type>_CTL` must be set to 1.

10.3.2 Not-ready Bit

The Not-ready (NRDY) bit, in the `MSMON_MBWU` and `MSMON_CSU` registers, when set, indicates that the monitor does not have an accurate count or measurement yet, because the monitor's settings have been recently changed. If the monitor requires some time to establish a new count or measurement after its settings are changed, the NRDY bit must be set automatically when the settings are changed and reset when the count or measurement is accurately represented in the monitor.

In the absence of another change in settings, the NRDY bit must clear automatically within a maximum length of time. The maximum time that NRDY may be 1 is an implementation parameter that is discoverable in the firmware data value of `MAX_NRDY_USEC` for the MSC's monitor type. For example, a measurement slow to respond to changes to what it measures could take up to `MAX_NRDY_USEC` to converge to a new fresh measurement.

Each instance of each type of monitor keeps its NRDY bit separately. For example, if MBWU monitor instance 3 is collecting memory bytes transferred for one partition and MBWU monitor instance 6 is later configured to collect for another partition, the configuration of MBWU monitor instance 6 must not disturb the on-going collection in MBWU monitor instance 3.

The NRDY bit of a monitor or capture register can be written to either state. On a monitor that measures resource and requires time to reach an accurate value, the NRDY bit must automatically reset when the measurement has become accurate. On a counting monitor, the NRDY bit remains set until it is reset by software writing it as 0 in the monitor register, or automatically after the monitor is captured in the capture register by a capture event.

If a monitor supports the automatic behaviors of NRDY, it must clear the NRDY when its measurements are accurate. It must also clear the NRDY if it is configured for capture and a capture event triggers.

If a monitor does not support automatic behavior of NRDY, software can use this bit for any purpose.

10.3.3 Capture event and capture register

Fields in `MSMON_CFG_CSU_CTL` and `MSMON_CFG_MBWU_CTL` control the behavior of a monitor instance that receives the capture event. Both registers must have the same fields for all monitor instances of a resource instance and monitor type.

A capture event causes every monitor that is configured to be sensitive to that event to be copied into that monitor's capture register.

Capture events may be local to the MSC or external to the MSC and may be software-initiated single events or a periodically repeating series of events. External capture events are system-defined. A generic counter can be used as the source of such an event, but this is not required. An external capture event could be distributed to all MSCs so that system-wide captures occur of all monitors sensitive to the external event. This permits using the various measurements for sums and differences because they measure the same period and (mostly) related resource usage.

A capture register for a monitor is loaded with the monitor's count or measurement and its NRDY bit when a capture event that is selected in the monitor's control register occurs. A capture event completes almost instantaneously, so no handshake is used for completion. However, the NRDY bit indicates whether a capture is not an accurate reading.

If the event is periodic, software can read the capture registers at any time to get the results captured when the most recent capture event occurred.

If it makes sense for the particular monitored value, the count or measurement can optionally be reset by the event. In this case, the value in the capture register represents a count over the capture-event period or a measurement over that period.

There are eight capture event codes:

Table 10-1 Capture events code and function

Capture event code	Function
0	No capture event
1 - 6	Available for use
7	Local capture event

A monitor instance does not respond to any capture event when the CAPT_EVNT field of the control register is set to 0, no capture event. This field can be set to an event number of 1 through 7. The instance is sensitive to a capture event matching the event number that CAPT_EVNT is set to.

Capture events are available to all monitors in the MSC. All monitor instances in all resource instances and of all monitor types can each be sensitive to any of the 7 capture event codes. Every monitor instance monitoring a PARTID space must be able to be sensitive to the same capture event.

Local capture-event generator

If `MPAMF_MSMON_IDR.HAS_LOCAL_CAPT_EVNT == 1`, the `MSMON_CAPT_EVNT` register exists and generates capture events that are local to an MSC when it is written with a value that contains a 1 in the NOW bit position.

There are separate `MSMON_CAPT_EVNT` registers for Secure and Non-secure address spaces. The Non-secure version generates a local capture event to all Non-secure monitors within the MSC that have been configured to use `MSMON_CFG_<type>_FLT.CAPT_EVNT == 7` (Table 10-2 on page 10-212). The Secure version of `MSMON_CAPT_EVNT` generates a local capture event to all Secure monitors within the MSC that have been configured to use `CAPT_EVNT == 7` when `MSMON_CAPT_EVNT` is written with `ALL == 0` and `NOW == 1`. When the ALL and NOW bits both == 1 in a write to Secure `MSMON_CAPT_EVNT`, the write generates a local capture event to all Secure and Non-secure monitors within the MSC that have been configured to use `CAPT_EVNT == 7`.

If `MPAMF_MSMON_IDR.HAS_LOCAL_CAPT_EVNT == 0`, local capture events are not generated and any monitors that have their control register set to `CAPT_EVNT == 7` do not receive any capture events.

Reset on capture

Monitors that keep a count of events, or that accumulate counts such as bytes transferred, may be optionally reset after a capture event transfers the count to the monitor's capture register. This behavior on capture is controlled by the `MSMON_CFG_*_CTL.CAPT_RESET` bit. If `CAPT_RESET == 1`, the monitor count is reset to 0 immediately after the value is captured into the `MSMON_*_CAPTURE` register.

Monitors that report a current resource value, such as cache-storage usage, that cannot reasonably be reset, do not need to support reset on capture behavior. Arm recommends that these monitors have the `CAPT_RESET` bit as RAZ/WI.

10.3.4 Overflow status bit

The `MSMON_CFG_<type>_CTL.OFLOW_STATUS` bit is set to 1 when the monitor counter overflows. This bit must be reset by writing 0 to the `OFLOW_STATUS` field.

The `MSMON_CFG_<type>_CTL` register contains fields to control MPAM behavior on an overflow. The `OFLOW_FRZ` bit, when set, freezes the counter after the count that caused it to overflow. When reset to 0, the counter continues to count after an overflow.

If the overflow changes the `OFLOW_STATUS` flag from 0 to 1 and the `OFLOW_INTR` bit is set, an MPAM overflow interrupt will be signaled if implemented. See also *MPAM overflow interrupt* on page 8-176.

10.3.5 Enable bit

The `MSMON_CFG_<type>_CTL.EN` bit is set to 1 when the monitor is enabled to collect information according to its configuration. When the EN bit is 0, the monitor is disabled and must not count events or measure resources. The monitor configuration registers can be written and read, regardless of the value of the monitor EN bit field.

10.4 Monitor configuration

For each type of resource monitor, the number of monitor instances that are available is described in the corresponding MPAMF_<type>MON_IDR.NUM_MON field.

The MSMON_CFG_MON_SEL.MON_SEL field selects the monitor instance to configure. The MON_SEL monitor instance of monitor type, type, is accessed when an MSMON_CFG_<type> register is accessed.

All monitor types have two 32-bit configuration registers:

- MSMON_CFG_<type>_FLT (Table 10-2 on page 10-212) has fields to select the PARTID and PMG to monitor.
- MSMON_CFG_<type>_CTL (Table 10-2 on page 10-212) has controls for counting a subset of events, controlling overflow, and capture behavior.

Some monitor types may not require all fields, and fields not required must be RAZ/WI or RAO/WI.

10.5 Monitor behavior on overflow

When an MPAM monitor instance overflows the OFLOW_STATUS flag in its configuration register is set to 1. Each monitor instance can be configured for a number of optional behaviors in its configuration register:

- Broadcast a configured capture event number to all other monitors in the MSC. See [Control of signaling to other monitor instances](#).
- Freeze a monitor instance. See [Control of monitor behavior on overflow](#).
- If the capture register is implemented the monitor instance can be captured to its capture register.
- Signal an overflow interrupt. See [Control of monitor behavior on overflow](#) and [MPAM overflow interrupt on page 8-176](#).

A monitor instance can be configured to respond to a capture event as an overflow. A capture event configured to be received by other monitor instances as an overflow can be caused by the overflow of a monitor that is configured to broadcast the capture event when the monitor overflows.

A group of monitor instances can be configured so that if any of them overflows, the overflow signals the others on a particular capture event number and all of the others respond by also performing overflow behaviors. See [Control over behavior of a monitor instance on a capture event on page 10-213](#).

Capture events are local to the MSC and are not broadcast to other MSCs.

There are seven capture event codes. See [Capture events code and function on page 10-209](#).

10.5.1 Control of monitor behavior on overflow

The behavior of a monitor instance on overflow is governed by fields in the [MSMON_CFG_CSU_CTL](#) and [MSMON_CFG_MBWU_CTL](#) registers:

Table 10-2 Control on overflow

Field	Bit	Control of behavior
OFLOW_LNKG	[10:8]	A capture event may be signaled to other monitor instances within the MSC with the capture event number in this field if it is not zero.
OFLOW_CAPT	[23]	The monitor instance VALUE field is captured into its capture register after the overflow occurs.
OFLOW_FRZ	[24]	The monitor instance VALUE field does not change after it overflows.
OFLOW_INTR	[25]	An interrupt is signaled after the monitor instance OFLOW_STATUS changes from 0 to 1.

The OFLOW_STATUS field of the [MSMON_CFG_CSU_CTL](#) and [MSMON_CFG_MBWU_CTL](#) registers for a monitor instance is set when the monitor instance VALUE overflows.

The monitor does not change the VALUE field to count events or update the resource measurement when it is frozen. The monitor instance resumes counting or measuring when OFLOW_STATUS is reset, either by writing [MSMON_CFG_CSU_CTL](#) and [MSMON_CFG_MBWU_CTL](#) registers with the OFLOW_STATUS field as 0 or by writing the monitor count register.

Writing the monitor count register resets OFLOW_STATUS as software often writes the monitor count register with a new starting value, for example 0.

10.5.2 Control of signaling to other monitor instances

The field OFLOW_LNKG in [MSMON_CFG_CSU_CTL](#) and [MSMON_CFG_MBWU_CTL](#) controls signaling other monitor instances when the monitor instance overflows.

If the monitor implements overflow linkage as indicated in MPAMF_<type>_MON_IDR.HAS_OFLOW_LNKG as 1, the monitor instances can be configured to signal a capture event when the count or measurement in a monitor register overflows.

To signal the overflow linkage capture event on the overflow of the VALUE field of an instance of `MSMON_<type>`, all of the following conditions must be met in the `MSMON_CFG_<type>_CTL` register:

- The `OFLOW_LNKG` field must be set to a non-zero value corresponding to a capture event implemented in the MSC.
- The `OFLOW_INTR` bit must be set to 1.

To signal the overflow linkage capture event on the overflow of the VALUE field an instance of `MSMON_<type>_L`, all the following conditions must be met in the `MSMON_CFG_<type>_CTL` register:

- The `OFLOW_LNKG` field must be set to a value other than zero, corresponding to a capture event implemented in the MSC.
- The `OFLOW_INTR_L` bit must be set to 1.

The capture event indicated in the `MSMON_CFG_<type>_CTL.OFLOW_LNKG` field is to all the monitor instances in the MSC that monitor the same PARTID space as the instance signaling the overflow.

10.5.3 Control over behavior of a monitor instance on a capture event

An external capture event is distributed to monitors for all PARTID spaces of the of the MSC.

Local capture events are distributed to:

- Monitor instances of the Non-secure PARTID space if originated from the Non-secure address space.
- Monitor instances of the Secure address space if originated from the Secure address space.
- Monitor instances of the Root PARTID address space if originated from the Root address space.
- Monitor instances of the Real PARTID address space if originated from the Realm address space.
- Monitor instances for both the Secure and Non-secure PARTID spaces if originated from the Secure address space that has the `MSMON_CAPT_EVNT.ALL` bit set to 1.
- Monitor instances for the same PARTID space as the overflowing monitor instance if the capture events are raised by overflow of a monitor instance with `OFLOW_LNKG` set to 1 through 6.

The behavior of a monitor instance that receives a capture event to which it is sensitive is controlled by settings in its control register. See `MSMON_CFG_CSU_CTL` and `MSMON_CFG_MBWU_CTL`.

Configuring the handling capture events as linked overflows

A capture event can be handled by a monitor instance as an overflow linkage and processed much as if this monitor instance had overflowed.

To configure a capture event to be handled as an overflow linkage, the `MSMON_CFG_<type>_CTL.CEVNT_OFLW` bit is set to 1 and `CAPT_EVNT` is set to the capture event number to be used for overflow linkage. The following controls in `MSMON_CFG_<type>_CTL` control the processing of a capture event when `CEVNT_OFLW` is 1:

- `OFLOW_FRZ` [24]: The monitor instance's VALUE is frozen and does not change until the monitor's VALUE has been written. If the monitor implements both normal and long versions of the count, both are frozen and each must be written to unfreeze its VALUE.
- `OFLOW_CAPT` [23]: The monitor instance's VALUE and NRDY fields are copied to the capture register. This field is present when `MPAMF_<type>MON_IDR` fields `HAS_CAPTURE` and `HAS_OFLOW_CAPT` are both 1.
- `OFLOW_CAPT_L` [13]: The monitor instance's long VALUE and NRDY fields are copied to the long capture register. This field is only in `MSMON_CFG_MBWU_CTL`. This field is present when `MPAMF_<type>MON_IDR` fields `HAS_CAPTURE`, `HAS_LONG` and `HAS_OFLOW_CAPT` are all 1.
- `CAPT_RESET` [27]: After the monitor instance is copied to its capture register, the monitor is reset to zero.

10.5.4 Monitors with and without capture

If capture is implemented for the monitor type, the following behavior is followed if only some of the control fields are implemented:

- Overflow linkage for signaling other monitor instances: A monitor that does not implement capture events can signal instances of other monitors that do if it implements OFLOW_LNKG and OFLOW_INTR in MSMON_CFG_<type>_CTL. If the long monitor register is also implemented, [MSMON_CFG_MBWU_CTL](#).OFLOW_INTR_L must also be implemented to control signaling of an overflow linkage event when the long monitor register's VALUE field overflows.

If capture is not implemented for the monitor type, the following behavior is followed if only some of the control fields are implemented:

- Freezing a monitor instance on a capture event: If capture is not implemented, a monitor instance that has not overflowed can be frozen by a capture event if it implements CAPT_EVNT and OFLOW_FRZ. To achieve this behavior, CAPT_EVNT must be set to a capture event 1 through 7. OFLOW_FRZ must be 1.

Chapter 11

Memory-mapped Registers

This chapter contains the following sections:

- *Overview of MMRs* on page 11-216.
- *Summary of memory-mapped registers* on page 11-222.
- *Memory-mapped ID register description* on page 11-225.
- *Memory-mapped partitioning configuration registers* on page 11-267.
- *Memory-mapped monitoring configuration registers* on page 11-311.
- *Memory-mapped control and status registers* on page 11-373.

11.1 Overview of MMRs

The MPAM behavior of an MSC is discovered and configured via memory-mapped registers (MMRs) in the MSC.

All MPAM MMRs are located on one of the MPAM feature pages for the MSC ([MPAM feature page on page 11-217](#)). An MSC's MPAM feature page is located from information about the device, possibly provided via firmware data such as device tree or ACPI ([Appendix B MSC Firmware Data](#)).

An MPAM feature page exists in the Non-secure address space and another exists in the Secure address space. If FEAT_RME is supported there is also a Root MPAM feature page in the Root address space and a Realm MPAM feature page in the Realm address space.

The addresses of the MPAM feature pages of an MSC do not need to have the same base address. Arm recommends that the numerical base addresses of the MPAM feature pages in different address spaces be sufficiently different that the numerical address ranges do not overlap.

MPAM MSC MMRs must support 32-bit access as a single access. There is no requirement that accesses of wider than 32 bits complete atomically.

There are MMRs for identifying MPAM parameters and options, the ID registers. These IDRs have the MPAMF prefix.

Other registers configure MPAM resource controls. These registers have the MPAMCFG prefix.

The resource monitor configuration and readout registers have the MSMON prefix.

There is a register to report the status of MPAM programming errors encountered in the MSC and a register to control MPAM interrupts.

11.1.1 Determining presence and location of MMRs

The [MPAMF_IDR](#) register is located at offset 0x0000 of the MPAM feature page. It indicates which MPAM resource controls are present in the MSC and the maximum PARTID and PMG supported in requests to the MSC. Other MPAMF ID registers are present if the corresponding MPAMF_IDR register bit is set and those registers identify the implemented values of architecturally-defined parameters associated with the particular class of MPAM resource control.

The MPAMF_IDR also indicates whether the MSC has MPAM monitors. If so, MPAMF_MSMON_IDR indicates which monitor types are supported by the MSC. Other monitor MPAMF ID registers are present if the corresponding bit in MPAMF_MSMON_IDR is set and those registers identify the implemented values of architecturally-defined parameters associated with the particular type of MPAM monitor.

The address of each MPAM MMR present in an MSC is located within the MPAM feature page for that component at a register-specific offset into that page. The offsets are given in tables in [Summary of memory-mapped registers on page 11-222](#) and [MPAM feature page on page 11-217](#).

11.1.2 Configuring resource controls for a partition

To configure the MPAM resource controls supported by an MSC for a PARTID:

1. Gain exclusive access to the MSC's partitioning configuration registers (for example, take a lock for the memory-mapped partitioning configuration registers, [Memory-mapped partitioning configuration registers on page 11-267](#)).
2. Write the PARTID to the component's MPAMCFG_PART_SEL.
3. Write to the MPAMCFG_* registers for the resource controls of the component.
4. Repeat step 3 to configure additional controls associated with the PARTID selected in step 2.
5. Repeat steps 2 through 4 to configure controls for additional PARTIDs.
6. Release exclusive access to the MSC's partitioning control configuration registers (for example, release the lock taken in step 1).

Repeat this procedure for each MSC.

The configuration registers are all the read-write registers that begin with MPAMCFG_*. That is all of the registers in [Memory-mapped partitioning configuration registers on page 11-267](#). Before writing any of these registers, software must take a lock to prevent other software from accessing these registers until the lock is released. This is in part because the writing involves first putting a PARTID into the MPAMCFG_PART_SEL register and then writing a configuration value into one or more of the MPAM resource control's configuration registers (also MPAMCFG_* registers).

Software must also take a lock to read any MPAMCFG_* register, other than MPAMCFG_PART_SEL, because reading also involves first putting a PARTID into MPAMCFG_PART_SEL register and then reading a configuration value from one or more of the MPAMCFG_* registers.

There are two copies of MPAMCFG_PART_SEL, one for resource controls for the Secure PARTID space that are accessed from the Secure address space, and the other for resource controls for the Non-secure PARTID space that are accessed from the Non-secure address space. Because there are two copies, there can be separate locks for Secure MPAMCFG_PART_SEL and for Non-secure MPAMCFG_PART_SEL.

11.1.3 Configuring memory-system monitors

To configure the memory-system monitors supported by an MSC for a PARTID and PMG:

1. Gain exclusive access to the MSC's monitor configuration registers (for example, take a lock for the memory-mapped monitoring configuration registers, [Memory-mapped monitoring configuration registers on page 11-311](#)).
2. Write to the component's MSMON_CFG_MON_SEL to select one of the monitor instances available in the component.
3. Write to the MSMON_CFG_* registers for the instance of the monitor type.
4. Repeat step 3 to configure additional registers associated with the monitor instance.
5. Repeat steps 2 through 4 to configure additional monitor instances.
6. Release the exclusive access to the MSC's monitor configuration registers (for example, release the lock taken in step 1).

Repeat this procedure for each MSC.

Software must also take the lock to read any MSMON_* register, other than MSMON_CFG_MON_SEL, because reading involves first writing a monitor index into MSMON_CFG_MON_SEL and then reading an MSMON register.

The monitor configuration registers are all of the registers in [Memory-mapped monitoring configuration registers on page 11-311](#). These registers have requirements similar to the MPAMCFG_* registers. The monitor configuration registers can have a separate lock or share the same lock as for the MPAMCFG_* registers. The selection register for monitors is MSMON_CFG_MON_SEL.

The configuration reading procedure of this section is also required to read the monitor and capture registers because these too are addressed by MSMON_CFG_MON_SEL.

There are two copies of MSMON_CFG_MON_SEL, one for Secure monitors that are accessed from the Secure address space and the other for Non-secure monitors that are accessed from the Non-secure address space. Because there are two copies, there can be separate locks for Secure MSMON_CFG_MON_SEL and for Non-secure MSMON_CFG_MON_SEL.

11.1.4 MPAM feature page

An MSC has an MPAM feature page in each of the supported address spaces. An MPAM feature page is a block of addresses that contains all of the MPAM MSC MMRs in that address space. Each MPAM feature page base address must be aligned to a 4 KB boundary.

Each MPAM feature page must be completely contained within a single 64 KB aligned block so that it may be placed within a single 64 KB page. Non-MPAM MMRs of the MSC are permitted within the 64 KB block if those MMRs are also to be trapped to a hypervisor.

Secure, Non-secure, Root and Realm address space

If the MSC supports the Secure address space (NS == 0), the Secure MPAM feature page must exist. The Non-secure MPAM feature page must always exist.

When FEAT_RME is implemented, the Root and Realm MPAM feature pages must exist. See [Four-space MSC on page 8-179](#).

MMRs describing (IDRs) or controlling (MPAMCFG*) Secure PARTIDs are within the Secure MPAM feature page, and those describing or controlling Non-secure PARTIDs are within the Non-secure MPAM feature page. MMRs describing or controlling PARTIDs in the Root PARTID space are within the Root MPAM feature page, and those describing or controlling PARTIDs in the Realm PARTID space are within the Realm MPAM feature page.

MPAM MMRs only in the Secure address space

Certain MPAM MMRs are only present within the MPAM feature page when accessed via the Secure address space (NS = 0). MPAMF_SIDR is the only MMR accessible only via the Secure address space.

Read-only MPAM MMRs permitted to read the same or differently

Some of the read-only MPAM MMRs are permitted to have the same or different contents between the Secure, Non-secure, Root and Realm MPAM feature pages. This includes all of the MPAMF*IDR registers. If the information regarding Secure and Non-secure PARTIDs is the same in an MPAMF*IDR, then the register is permitted to have the same contents.

These registers are permitted to be shared if the same or banked if different in the two address spaces:

MPAMF_IDR	MPAMF_IMPL_IDR	MPAMF_CPOR_IDR
MPAMF_CCAP_IDR	MPAMF_MBW_IDR	MPAMF_PRI_IDR
MPAMF_PARTID_NRW_IDR	MPAMF_MSMON_IDR	MPAMF_CSUMON_IDR
MPAMF_MBWUMON_IDR		

MPAM MMRs that must have the same contents

Two registers must have the same contents between the Secure and Non-secure MPAM feature pages. These registers contain read-only values that must read as the same value in the two address spaces:

MPAMF_IIDR	MPAMF_AIDR
------------	------------

MPAM MMRs that must be separate registers for each address space

Most MPAM MMRs, such as the following, must be separate and have Secure, Non-secure, Root and Realm versions that are accessed through the corresponding Secure, Non-secure, Root and Realm MPAM feature pages:

MPAMF_ECR	MPAMCFG_PART_SEL	MSMON_CFG_MON_SEL
MPAMF_ESR	MPAMCFG_MBW_MAX	MSMON_CFG_CSU_CTL
	MPAMCFG_MBW_MIN	MSMON_CFG_CSU_FLT
MPAMCFG_CMAX	MPAMCFG_MBW_PBM	MSMON_CSU

MPAMCFG_CPBM	MPAMCFG_MBW_PROP	MSMON_CSU_CAPTURE
	MPAMCFG_MBW_WINWD	MSMON_CFG_MBWU_CTL
MPAMCFG_PRI		MSMON_CFG_MBWU_FLT
MPAMCFG_INTPARTID		MSMON_MBWU
		MSMON_MBWU_CAPTURE

Accesses to locations where there is no register in the address space of the access

Access to MPAM MMR address where there is no register in the address space of the access must be treated as reserved MPAM feature page locations according to [IMPLEMENTATION DEFINED memory-mapped registers and reserved feature page locations](#), except for the MPAMCFG_MBW_PBM and MPAMCFG_CPBM as described in [Permitted truncation of an MPAM feature page](#).

Permitted truncation of an MPAM feature page

An MPAM feature page may be shortened in only two cases:

- If MPAMCFG_MBW_PBM is not implemented ($MPAMF_IDR.HAS_MBW_PART == 0 \parallel (MPAM_IDR.HAS_MBW_PART == 1 \ \&\& \ MPAM_MBW_IDR.HAS_PBM == 0)$), the maximum offset for the MPAM feature page is $0x01FFF$.
- If MPAMCFG_MBW_PBM is not implemented and MPAMCFG_CPBM is not implemented ($MPAMF_IDR.HAS_CPOR == 0$), the maximum offset for the MPAM feature page is $0x00FFF$.

11.1.5 Minimum required MPAM memory-mapped registers

If an MSC has any support for MPAM, the following registers are required:

- MPAMF_IDR.
- MPAMF_AIDR.
- MPAMF_IIDR.
- MPAMF_SIDR, if the Secure address space is supported.

If an MSC supports any resource controls, the following registers are also required:

- MPAMCFG_PART_SEL.

If an MSC supports any resource monitors, the following registers are also required:

- MPAMF_MSMON_IDR.
- MSMON_CFG_MON_SEL.

If an MSC can detect any errors, it must implement:

- MPAMF_ESR.
- MPAMF_ECR.

MSC MPAM MMRs not mentioned in this section are optional and expected to be implemented only when the resource control or monitor that the register supports is implemented.

See [Examples of partial MPAM implementations on page 11-220](#) for examples showing MPAMF_*IDR registers in implementations with few MPAM functions.

11.1.6 IMPLEMENTATION DEFINED memory-mapped registers and reserved feature page locations

IMPLEMENTATION DEFINED MPAM memory-mapped registers are permitted in the MPAM feature page at offsets equal to or greater than $0x3000$.

All locations in the MPAM feature page at offsets less than the maximum MPAM feature page offset defined in [Permitted truncation of an MPAM feature page on page 11-219](#) are reserved to the architecture. Within that address range:

- Reads and writes of unallocated locations are reserved accesses.
- Reads and writes of locations for registers that are not implemented are reserved accesses, including register locations for:
 - Optional MPAM MSC features that are not implemented.
 - ID registers for optional MPAM MSC features that are not implemented and indicated as not implemented in ID registers that are implemented.
- Locations that are beyond the implemented width of a register as given in the corresponding ID register but within the range of locations allocated by the architecture are reserved accesses.
- Reads of WO locations are reserved accesses.
- Writes to RO locations are reserved accesses.

The architecture requires reserved accesses to be implemented as RAZ/WI. However, software must not rely on this property as the behavior of reserved values might change in a future revision of the MPAM Extension architecture. Software must treat reserved accesses as RES0.

11.1.7 Examples of partial MPAM implementations

Most MSCs only implement a fraction of the full MSC MPAM architecture. This section gives examples of partial implementations, some of which have been achieved by partially removing MPAM. The RTL configuration examples are included to illustrate the MMR issues in partial MPAM implementations.

An MSC that has no partitioning or monitoring, only propagation

An MSC that does not implement any resource partitioning or monitor interfaces only requires a few MMRs:

- The minimum required MMRs, as specified in [Minimum required MPAM memory-mapped registers on page 11-219](#), must be implemented with the `MPAMF_IDR`. {PARTID_MAX, PMG_MAX} fields indicating the maximum PARTID that can be propagated.
- All of the HAS_* and NO_* bits in `MPAMF_IDR` must be zero.
- `MPAMF_AIDR` must indicate MPAM v1.0 or MPAM v1.1.
- `MPAMF_IIDR` must identify the implementation.
- `MPAMF_SIDR` must indicate PARTID_MAX and PMG_MAX for Secure propagation.

No other registers are required.

An MSC when RTL configuration has removed a partitioning control or resource usage monitor

An MSC could be designed to have an RTL configuration option that removes a partitioning control or a resource usage monitor. If so, the HAS_* bits in each of the relevant `MPAMF_*IDR` registers must be configured to zero when the feature is removed.

An MSC when RTL configuration has removed all MPAM functionality

An MSC could be designed to have an RTL configuration option that removes all of the MPAM functionality. When all of MPAM is deconfigured:

- The minimum required MPAM registers must be present.
- `MPAMF_IDR`, `MPAMF_AIDR` and `MPAMF_SIDR` must all be zero.
- `MPAMF_IIDR` is permitted to be either all zero or to identify the IP.

Note

Software might still attempt to discover MPAM on this RTL configuration, so the minimum MPAM registers must be present to allow the lack of MPAM function to be discovered.

An MSC when RTL configuration removes a resource instance

An MSC could be designed to have an RTL configuration option that completely removes one or more resource instances. When a resource instance is removed, only the MPAMF_*IDR registers for the corresponding RIS values are changed. All of the ID registers corresponding to that RIS value have each of their RIS-specific fields set to zero. For more information on RIS-specific fields, see [Effects of MPAMCFG_PART_SEL.RIS on values read from other registers on page 8-167](#).

11.2 Summary of memory-mapped registers

Table 11-1 lists the external MPAM registers in order of register offset.

Table 11-1 Index of external MPAM registers ordered by offset

Register	Offset	Length	Description, see
MPAMF_IDR	0x0000	64	<i>MPAMF_IDR</i> , <i>MPAM Features Identification Register</i> on page 11-237
MPAMF_SIDR	0x0008	32	<i>MPAMF_SIDR</i> , <i>MPAM Features Secure Identification Register</i> on page 11-266
MPAMF_IIDR	0x0018	32	<i>MPAMF_IIDR</i> , <i>MPAM Implementation Identification Register</i> on page 11-245
MPAMF_AIDR	0x0020	32	<i>MPAMF_AIDR</i> , <i>MPAM Architecture Identification Register</i> on page 11-226
MPAMF_IMPL_IDR	0x0028	32	<i>MPAMF_IMPL_IDR</i> , <i>MPAM Implementation-Specific Partitioning Feature Identification Register</i> on page 11-247
MPAMF_CPOR_IDR	0x0030	32	<i>MPAMF_CPOR_IDR</i> , <i>MPAM Features Cache Portion Partitioning ID register</i> on page 11-231
MPAMF_CCAP_IDR	0x0038	32	<i>MPAMF_CCAP_IDR</i> , <i>MPAM Features Cache Capacity Partitioning ID register</i> on page 11-228
MPAMF_MBW_IDR	0x0040	32	<i>MPAMF_MBW_IDR</i> , <i>MPAM Memory Bandwidth Partitioning Identification Register</i> on page 11-249
MPAMF_PRI_IDR	0x0048	32	<i>MPAMF_PRI_IDR</i> , <i>MPAM Priority Partitioning Identification Register</i> on page 11-263
MPAMF_PARTID_NRW_IDR	0x0050	32	<i>MPAMF_PARTID_NRW_IDR</i> , <i>MPAM PARTID Narrowing ID register</i> on page 11-261
MPAMF_MSMON_IDR	0x0080	32	<i>MPAMF_MSMON_IDR</i> , <i>MPAM Resource Monitoring Identification Register</i> on page 11-257
MPAMF_CSUMON_IDR	0x0088	32	<i>MPAMF_CSUMON_IDR</i> , <i>MPAM Features Cache Storage Usage Monitoring ID register</i> on page 11-233
MPAMF_MBWUMON_IDR	0x0090	32	<i>MPAMF_MBWUMON_IDR</i> , <i>MPAM Features Memory Bandwidth Usage Monitoring ID register</i> on page 11-253
MPAMF_ERR_MSI_MPAM	0x00DC	32	<i>MPAMF_ERR_MSI_MPAM</i> , <i>MPAM Error MSI Write MPAM Information Register</i> on page 11-385
MPAMF_ERR_MSI_ADDR_L	0x00E0	32	<i>MPAMF_ERR_MSI_ADDR_L</i> , <i>MPAM Error MSI Low-part Address Register</i> on page 11-378
MPAMF_ERR_MSI_ADDR_H	0x00E4	32	<i>MPAMF_ERR_MSI_ADDR_H</i> , <i>MPAM Error MSI High-part Address Register</i> on page 11-376
MPAMF_ERR_MSI_DATA	0x00E8	32	<i>MPAMF_ERR_MSI_DATA</i> , <i>MPAM Error MSI Data Register</i> on page 11-383
MPAMF_ERR_MSI_ATTR	0x00EC	32	<i>MPAMF_ERR_MSI_ATTR</i> , <i>MPAM Error MSI Write Attributes Register</i> on page 11-380
MPAMF_ECR	0x00F0	32	<i>MPAMF_ECR</i> , <i>MPAM Error Control Register</i> on page 11-374
MPAMF_ESR	0x00F8	64	<i>MPAMF_ESR</i> , <i>MPAM Error Status Register</i> on page 11-387

Table 11-1 Index of external MPAM registers ordered by offset (continued)

Register	Offset	Length	Description, see
MPAMCFG_PART_SEL	0x0100	32	<i>MPAMCFG_PART_SEL, MPAM Partition Configuration Selection Register on page 11-305</i>
MPAMCFG_CMAX	0x0108	32	<i>MPAMCFG_CMAX, MPAM Cache Maximum Capacity Partition Configuration Register on page 11-271</i>
MPAMCFG_CMIN	0x0110	32	<i>MPAMCFG_CMIN, MPAM Cache Minimum Capacity Partition Configuration Register on page 11-274</i>
MPAMCFG_CASSOC	0x0118	32	<i>MPAMCFG_CASSOC, MPAM Cache Maximum Associativity Partition Configuration Register on page 11-268</i>
MPAMCFG_MBW_MIN	0x0200	32	<i>MPAMCFG_MBW_MIN, MPAM Memory Bandwidth Minimum Partition Configuration Register on page 11-293</i>
MPAMCFG_MBW_MAX	0x0208	32	<i>MPAMCFG_MBW_MAX, MPAM Memory Bandwidth Maximum Partition Configuration Register on page 11-290</i>
MPAMCFG_MBW_WINWD	0x0220	32	<i>MPAMCFG_MBW_WINWD, MPAM Memory Bandwidth Partitioning Window Width Configuration Register on page 11-302</i>
MPAMCFG_EN	0x0300	32	<i>MPAMCFG_EN, MPAM Partition Configuration Enable Register on page 11-282</i>
MPAMCFG_DIS	0x0310	32	<i>MPAMCFG_DIS, MPAM Partition Configuration Disable Register on page 11-280</i>
MPAMCFG_EN_FLAGS	0x0320	32	<i>MPAMCFG_EN_FLAGS, MPAM Partition Configuration Enable Flags Register on page 11-284</i>
MPAMCFG_PRI	0x0400	32	<i>MPAMCFG_PRI, MPAM Priority Partition Configuration Register on page 11-308</i>
MPAMCFG_MBW_PROP	0x0500	32	<i>MPAMCFG_MBW_PROP, MPAM Memory Bandwidth Proportional Stride Partition Configuration Register on page 11-299</i>
MPAMCFG_INTPARTID	0x0600	32	<i>MPAMCFG_INTPARTID, MPAM Internal PARTID Narrowing Configuration Register on page 11-287</i>
MSMON_CFG_MON_SEL	0x0800	32	<i>MSMON_CFG_MON_SEL, MPAM Monitor Instance Selection Register on page 11-332</i>
MSMON_CAPT_EVNT	0x0808	32	<i>MSMON_CAPT_EVNT, MPAM Capture Event Generation Register on page 11-312</i>
MSMON_CFG_CSU_FLT	0x0810	32	<i>MSMON_CFG_CSU_FLT, MPAM Memory System Monitor Configure Cache Storage Usage Monitor Filter Register on page 11-319</i>
MSMON_CFG_CSU_CTL	0x0818	32	<i>MSMON_CFG_CSU_CTL, MPAM Memory System Monitor Configure Cache Storage Usage Monitor Control Register on page 11-314</i>
MSMON_CFG_MBWU_FLT	0x0820	32	<i>MSMON_CFG_MBWU_FLT, MPAM Memory System Monitor Configure Memory Bandwidth Usage Monitor Filter Register on page 11-329</i>
MSMON_CFG_MBWU_CTL	0x0828	32	<i>MSMON_CFG_MBWU_CTL, MPAM Memory System Monitor Configure Memory Bandwidth Usage Monitor Control Register on page 11-322</i>

Table 11-1 Index of external MPAM registers ordered by offset (continued)

Register	Offset	Length	Description, see
MSMON_CSU	0x0840	32	<i>MSMON_CSU</i> , MPAM Cache Storage Usage Monitor Register on page 11-335
MSMON_CSU_CAPTURE	0x0848	32	<i>MSMON_CSU_CAPTURE</i> , MPAM Cache Storage Usage Monitor Capture Register on page 11-338
MSMON_CSU_OFSR	0x0858	32	<i>MSMON_CSU_OFSR</i> , MPAM CSU Monitor Overflow Status Register on page 11-341
MSMON_MBWU	0x0860	32	<i>MSMON_MBWU</i> , MPAM Memory Bandwidth Usage Monitor Register on page 11-344
MSMON_MBWU_CAPTURE	0x0868	32	<i>MSMON_MBWU_CAPTURE</i> , MPAM Memory Bandwidth Usage Monitor Capture Register on page 11-347
MSMON_MBWU_L	0x0880	64	<i>MSMON_MBWU_L</i> , MPAM Long Memory Bandwidth Usage Monitor Register on page 11-350
MSMON_MBWU_L_CAPTURE	0x0890	64	<i>MSMON_MBWU_L_CAPTURE</i> , MPAM Long Memory Bandwidth Usage Monitor Capture Register on page 11-353
MSMON_MBWU_OFSR	0x0898	32	<i>MSMON_MBWU_OFSR</i> , MPAM MBWU Monitor Overflow Status Register on page 11-356
MSMON_OFLOW_MSI_MPAM	0x08DC	32	<i>MSMON_OFLOW_MSI_MPAM</i> , MPAM Monitor Overflow MSI Write MPAM Information Register on page 11-368
MSMON_OFLOW_MSI_ADDR_L	0x08E0	32	<i>MSMON_OFLOW_MSI_ADDR_L</i> , MPAM Monitor Overflow MSI Low-part Address Register on page 11-361
MSMON_OFLOW_MSI_ADDR_H	0x08E4	32	<i>MSMON_OFLOW_MSI_ADDR_H</i> , MPAM Monitor Overflow MSI Write High-part Address Register on page 11-359
MSMON_OFLOW_MSI_DATA	0x08E8	32	<i>MSMON_OFLOW_MSI_DATA</i> , MPAM Monitor Overflow MSI Write Data Register on page 11-366
MSMON_OFLOW_MSI_ATTR	0x08EC	32	<i>MSMON_OFLOW_MSI_ATTR</i> , MPAM Monitor Overflow MSI Write Attributes Register on page 11-363
MSMON_OFLOW_SR	0x08F0	32	<i>MSMON_OFLOW_SR</i> , MPAM Monitor Overflow Status Register on page 11-370
MPAMCFG_CPBM<n>	0x1000	32	<i>MPAMCFG_CPBM<n></i> , MPAM Cache Portion Bitmap Partition Configuration Register, n = 0 - 1023 on page 11-277
MPAMCFG_MBW_PBM<n>	0x2000	32	<i>MPAMCFG_MBW_PBM<n></i> , MPAM Bandwidth Portion Bitmap Partition Configuration Register, n = 0 - 127 on page 11-296

11.3 Memory-mapped ID register description

This section lists the external ID registers.

11.3.1 MPAMF_AIDR, MPAM Architecture Identification Register

The MPAMF_AIDR characteristics are:

Purpose

Identifies the version of the MPAM architecture that this MSC implements.

Note: The following values are defined for bits [7:0]:

- 0x01 == MPAM architecture v0.1
- 0x10 == MPAM architecture v1.0
- 0x11 == MPAM architecture v1.1

Configurations

The power domain of MPAMF_AIDR is IMPLEMENTATION DEFINED.

This register is present only when FEAT_MPAM is implemented. Otherwise, direct accesses to MPAMF_AIDR are RES0.

The power and reset domain of each MSC component is specific to that component.

Attributes

MPAMF_AIDR is a 32-bit register.

Field descriptions

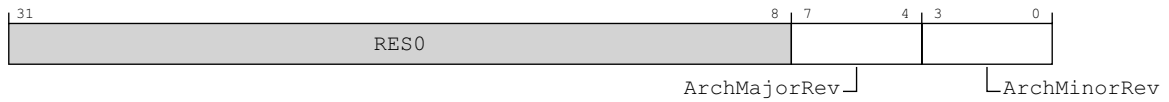

Bits [31:8]

Reserved, RES0.

ArchMajorRev, bits [7:4]

Major revision of the MPAM architecture implemented by the MSC.

This table shows the only valid combinations of MPAM version numbers in an MSC. FORCE_NS functionality is only available in MPAM v0.1.

ArchMajorRev	ArchMinorRev	MPAMv	Available
0	0		None.
0	1	v0.1	MPAMv1.0 + MPAMv1.1 + FORCE_NS
1	0	v1.0	MPAMv1.0
1	1	v1.1	MPAMv1.0 + MPAMv1.1 - FORCE_NS

Use of MPAMv0.1 in MSCs is restricted to limited circumstances. The MSC must be able to initiate requests in the Secure address space which have MPAM PARTID forced to the Non-secure space with that forcing not controllable or observable by the software that configures the device for Secure requests. Please contact Arm before setting MPAMF_AIDR to report MPAMv0.1.

ArchMinorRev, bits [3:0]

Minor revision of the MPAM architecture implemented by the MSC.

See the table in the description of the ArchMajorRev field in this register.

Accessing the MPAMF_AIDR:

This register is within the MPAM feature page memory frames.

In a system that supports Secure, Non-secure, Root, and Realm memory maps, there must be MPAM feature pages in all four address maps.

MPAMF_AIDR is read-only.

MPAMF_AIDR must be readable from the Secure, Non-secure, Root, and Realm MPAM feature pages.

MPAMF_AIDR must have the same contents in the Secure, Non-secure, Root, and Realm MPAM feature pages.

MPAMF_AIDR can be accessed through its memory-mapped interface:

Component	Frame	Offset	Instance
MPAM	MPAMF_BASE_s	0x0020	MPAMF_AIDR_s

Accesses to this interface are RO.

MPAMF_AIDR can be accessed through its memory-mapped interface:

Component	Frame	Offset	Instance
MPAM	MPAMF_BASE_ns	0x0020	MPAMF_AIDR_ns

Accesses to this interface are RO.

MPAMF_AIDR can be accessed through its memory-mapped interface:

Component	Frame	Offset	Instance
MPAM	MPAMF_BASE_rt	0x0020	MPAMF_AIDR_rt

When FEAT_RME is implemented, accesses to this interface are RO.

MPAMF_AIDR can be accessed through its memory-mapped interface:

Component	Frame	Offset	Instance
MPAM	MPAMF_BASE_rl	0x0020	MPAMF_AIDR_rl

When FEAT_RME is implemented, accesses to this interface are RO.

11.3.2 MPAMF_CCAP_IDR, MPAM Features Cache Capacity Partitioning ID register

The MPAMF_CCAP_IDR characteristics are:

Purpose

Indicates the number of fractional bits in [MPAMCFG_CMAX.CMAX](#).

MPAMF_CCAP_IDR_s indicates the number of fractional bits in the Secure instance of [MPAMCFG_CMAX](#). MPAMF_CCAP_IDR_ns indicates the number of fractional bits in the Non-secure instance of [MPAMCFG_CMAX](#). MPAMF_CCAP_IDR_rt indicates the number of fractional bits in the Root cache capacity control settings register field, [MPAMCFG_CMAX.CMAX](#). MPAMF_CCAP_IDR_rl indicates the number of fractional bits in the Realm cache capacity control settings register field, [MPAMCFG_CMAX.CMAX](#).

When [MPAMF_IDR.HAS_RIS](#) is 1, some fields in this register give information for the resource instance selected by [MPAMCFG_PART_SEL.RIS](#). The description of every field that is affected by [MPAMCFG_PART_SEL.RIS](#) has information within the field description.

Configurations

The power domain of MPAMF_CCAP_IDR is IMPLEMENTATION DEFINED.

This register is present only when FEAT_MPAM is implemented and [MPAMF_IDR.HAS_CCAP_PART](#) == 1. Otherwise, direct accesses to MPAMF_CCAP_IDR are RES0.

The power and reset domain of each MSC component is specific to that component.

Attributes

MPAMF_CCAP_IDR is a 32-bit register.

Field descriptions

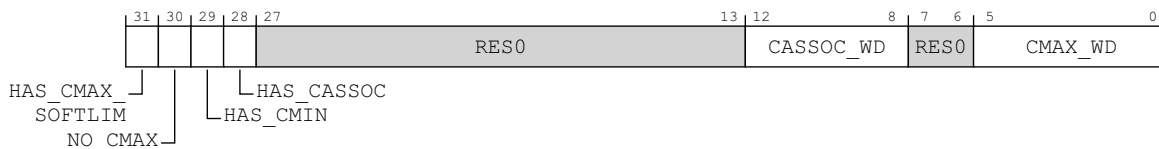

HAS_CMAX_SOFTLIM, bit [31]

When FEAT_MPAMv0p1 is implemented or FEAT_MPAMv1p1 is implemented:

Has soft limiting selection field in [MPAMCFG_CMAX](#).

0b0 If [MPAMCFG_CMAX](#) is implemented, it has no SOFTLIM field and the maximum capacity is controlled with a hard limit.

0b1 If [MPAMCFG_CMAX](#) is implemented, that register has a SOFTLIMIT field to select between hard or soft limiting to the CMAX parameter.

If RIS is implemented, this field indicates selectable limiting for the cache maximum capacity control for the resource instance selected by [MPAMCFG_PART_SEL.RIS](#).

Otherwise:

Reserved, RES0.

NO_CMAX, bit [30]

When FEAT_MPAMv0p1 is implemented or FEAT_MPAMv1p1 is implemented:

Does not have CMAX partitioning.

0b0 [MPAMCFG_CMAX](#) is implemented.

0b1 [MPAMCFG_CMAX](#) is not implemented.

If RIS is implemented, this field indicates the absence of a cache maximum capacity partitioning control for the resource instance selected by [MPAMCFG_PART_SEL.RIS](#).

Otherwise:

Reserved, RES0.

HAS_CMIN, bit [29]

When FEAT_MPAMv0p1 is implemented or FEAT_MPAMv1p1 is implemented:

Has cache minimum capacity partitioning.

0b0 [MPAMCFG_CMIN](#) is not implemented.

0b1 [MPAMCFG_CMIN](#) is implemented.

If RIS is implemented, this field indicates the presence of a cache minimum capacity partitioning control for the resource instance selected by [MPAMCFG_PART_SEL.RIS](#).

Otherwise:

Reserved, RES0.

HAS_CASSOC, bit [28]

When FEAT_MPAMv0p1 is implemented or FEAT_MPAMv1p1 is implemented:

Has cache maximum associativity partitioning.

0b0 [MPAMCFG_CASSOC](#) is not implemented.

0b1 [MPAMCFG_CASSOC](#) is implemented.

If RIS is implemented, this field indicates the presence of a cache maximum associativity partitioning control for the resource instance selected by [MPAMCFG_PART_SEL.RIS](#).

Otherwise:

Reserved, RES0.

Bits [27:13]

Reserved, RES0.

CASSOC_WD, bits [12:8]

When FEAT_MPAMv0p1 is implemented or FEAT_MPAMv1p1 is implemented:

Number of fractional bits implemented in the cache associativity partitioning control, [MPAMCFG_CASSOC.CASSOC](#), of this MSC. See [MPAMCFG_CASSOC](#).

If RIS is implemented, this field indicates the number of fractional bits in the cache capacity partitioning control for the resource instance selected by [MPAMCFG_PART_SEL.RIS](#).

Otherwise:

Reserved, RES0.

Bits [7:6]

Reserved, RES0.

CMAX_WD, bits [5:0]

Number of fractional bits implemented in the cache capacity partitioning control, [MPAMCFG_CMAX.CMAX](#), of this device. See [MPAMCFG_CMAX](#).

This field must contain a value from 1 to 16, inclusive.

If RIS is implemented, this field indicates the number of fractional bits in the cache capacity partitioning control for the resource instance selected by [MPAMCFG_PART_SEL.RIS](#).

Accessing the MPAMF_CCAP_IDR:

This register is within the MPAM feature page memory frames. In a system that supports Secure, Non-secure, Root, and Realm memory maps, there must be MPAM feature pages in all four address maps.

MPAMF_CCAP_IDR is read-only.

MPAMF_CCAP_IDR must be readable from the Non-secure, Secure, Root, and Realm MPAM feature pages.

MPAMF_CCAP_IDR is permitted to have the same contents when read from the Secure, Non-secure, Root, and Realm MPAM feature pages unless the register contents are different for the different versions:

- MPAMF_CCAP_IDR_s is permitted to have either the same or different contents to MPAMF_CCAP_IDR_ns, MPAMF_CCAP_IDR_rt, or MPAMF_CCAP_IDR_rl.
- MPAMF_CCAP_IDR_ns is permitted to have either the same or different contents to MPAMF_CCAP_IDR_rt or MPAMF_CCAP_IDR_rl.
- MPAMF_CCAP_IDR_rt is permitted to have either the same or different contents to MPAMF_CCAP_IDR_rl.

There must be separate registers in the Secure (MPAMF_CCAP_IDR_s), Non-secure (MPAMF_CCAP_IDR_ns), Root (MPAMF_CCAP_IDR_rt), and Realm (MPAMF_CCAP_IDR_rl) MPAM feature pages.

When [MPAMF_IDR.HAS_RIS](#) is 1, MPAMF_CCAP_IDR shows the configuration of cache capacity partitioning for the cache resource instance selected by [MPAMCFG_PART_SEL.RIS](#). Fields that mention RIS in their field descriptions have values that track the implemented properties of the resource instance. Fields that do not mention RIS are constant across all resource instances.

MPAMF_CCAP_IDR can be accessed through its memory-mapped interface:

Component	Frame	Offset	Instance
MPAM	MPAMF_BASE_s	0x0038	MPAMF_CCAP_IDR_s

Accesses to this interface are RO.

MPAMF_CCAP_IDR can be accessed through its memory-mapped interface:

Component	Frame	Offset	Instance
MPAM	MPAMF_BASE_ns	0x0038	MPAMF_CCAP_IDR_ns

Accesses to this interface are RO.

MPAMF_CCAP_IDR can be accessed through its memory-mapped interface:

Component	Frame	Offset	Instance
MPAM	MPAMF_BASE_rt	0x0038	MPAMF_CCAP_IDR_rt

When FEAT_RME is implemented, accesses to this interface are RO.

MPAMF_CCAP_IDR can be accessed through its memory-mapped interface:

Component	Frame	Offset	Instance
MPAM	MPAMF_BASE_rl	0x0038	MPAMF_CCAP_IDR_rl

When FEAT_RME is implemented, accesses to this interface are RO.

11.3.3 MPAMF_CPOR_IDR, MPAM Features Cache Portion Partitioning ID register

The MPAMF_CPOR_IDR characteristics are:

Purpose

Indicates the number of bits in [MPAMCFG_CPBM<n>](#).

MPAMF_CPOR_IDR_s indicates the number of bits in the Secure instance of [MPAMCFG_CPBM<n>](#). MPAMF_CPOR_IDR_ns indicates the number of bits in the Non-secure instance of [MPAMCFG_CPBM<n>](#). MPAMF_CPOR_IDR_rt indicates the number of bits in the Root instance of [MPAMCFG_CPBM<n>](#). MPAMF_CPOR_IDR_rl indicates the number of bits in the Realm instance of [MPAMCFG_CPBM<n>](#).

When [MPAMF_IDR.HAS_RIS](#) is 1, some fields in this register give information for the resource instance selector, [MPAMCFG_PART_SEL.RIS](#). The description of every field that is affected by [MPAMCFG_PART_SEL.RIS](#) has information within the field description.

Configurations

The power domain of MPAMF_CPOR_IDR is IMPLEMENTATION DEFINED.

This register is present only when FEAT_MPAM is implemented and [MPAMF_IDR.HAS_CPOR_PART](#) == 1. Otherwise, direct accesses to MPAMF_CPOR_IDR are RES0.

The power and reset domain of each MSC component is specific to that component.

Attributes

MPAMF_CPOR_IDR is a 32-bit register.

Field descriptions



Bits [31:16]

Reserved, RES0.

CPBM_WD, bits [15:0]

Number of bits in the cache portion partitioning bit map of this device. See [MPAMCFG_CPBM<n>](#).

This field must contain a value from 1 to 32768, inclusive. Values greater than 32 require a group of 32-bit registers to access the CPBM, up to 1024 if CPBM_WD is the largest value.

If RIS is implemented, this field indicates the number bits in the cache portion bitmap for the resource instance selected by [MPAMCFG_PART_SEL.RIS](#).

Accessing the MPAMF_CPOR_IDR:

This register is within the MPAM feature page memory frames. In a system that supports Secure, Non-secure, Root, and Realm memory maps, there must be MPAM feature pages in all four address maps.

MPAMF_CPOR_IDR is read-only.

MPAMF_CPOR_IDR must be readable from the Non-secure, Secure, Root, and Realm MPAM feature pages.

MPAMF_CPOR_IDR is permitted to have the same contents when read from the Secure, Non-secure, Root, and Realm MPAM feature pages unless the register contents are different for the different versions:

- MPAMF_CPOR_IDR_s is permitted to have either the same or different contents to MPAMF_CPOR_IDR_ns, MPAMF_CPOR_IDR_rt, or MPAMF_CPOR_IDR_rl.

- MPAMF_CPOR_IDR_ns is permitted to have either the same or different contents to MPAMF_CPOR_IDR_rt or MPAMF_CPOR_IDR_rl.
- MPAMF_CPOR_IDR_rt is permitted to have either the same or different contents to MPAMF_CPOR_IDR_rl.

There must be separate registers in the Secure (MPAMF_CPOR_IDR_s), Non-secure (MPAMF_CPOR_IDR_ns), Root (MPAMF_CPOR_IDR_rt), and Realm (MPAMF_CPOR_IDR_rl) MPAM feature pages.

When [MPAMF_IDR.HAS_RIS](#) is 1, MPAMF_CPOR_IDR shows the configuration of cache portion partitioning for the cache resource instance selected by [MPAMCFG_PART_SEL.RIS](#). Fields that mention RIS in their field descriptions have values that track the implemented properties of the resource instance. Fields that do not mention RIS are constant across all resource instances.

MPAMF_CPOR_IDR can be accessed through its memory-mapped interface:

Component	Frame	Offset	Instance
MPAM	MPAMF_BASE_s	0x0030	MPAMF_CPOR_IDR_s

Accesses to this interface are RO.

MPAMF_CPOR_IDR can be accessed through its memory-mapped interface:

Component	Frame	Offset	Instance
MPAM	MPAMF_BASE_ns	0x0030	MPAMF_CPOR_IDR_ns

Accesses to this interface are RO.

MPAMF_CPOR_IDR can be accessed through its memory-mapped interface:

Component	Frame	Offset	Instance
MPAM	MPAMF_BASE_rt	0x0030	MPAMF_CPOR_IDR_rt

When FEAT_RME is implemented, accesses to this interface are RO.

MPAMF_CPOR_IDR can be accessed through its memory-mapped interface:

Component	Frame	Offset	Instance
MPAM	MPAMF_BASE_rl	0x0030	MPAMF_CPOR_IDR_rl

When FEAT_RME is implemented, accesses to this interface are RO.

11.3.4 MPAMF_CSUMON_IDR, MPAM Features Cache Storage Usage Monitoring ID register

The MPAMF_CSUMON_IDR characteristics are:

Purpose

Indicates the number of cache storage usage monitor instances and other properties of the CSU monitoring.

MPAMF_CSUMON_IDR_s indicates the number and properties of Secure cache storage usage monitoring. MPAMF_CSUMON_IDR_ns indicates the number and properties of Non-secure cache storage usage monitoring. MPAMF_CSUMON_IDR_rt indicates the number and properties of Root cache storage usage monitoring. MPAMF_CSUMON_IDR_rl indicates the number and properties of Realm cache storage usage monitoring.

If MPAMF_IDR.HAS_RIS is 1, fields that mention RIS must reflect the properties of the resource instance currently selected by MPAMCFG_PART_SEL.RIS. Fields that do not mention RIS are constant across all resource instances.

Configurations

The power domain of MPAMF_CSUMON_IDR is IMPLEMENTATION DEFINED.

This register is present only when FEAT_MPAM is implemented, MPAMF_IDR.HAS_MSMON == 1 and MPAMF_MSMON_IDR.MSMON_CSU == 1. Otherwise, direct accesses to MPAMF_CSUMON_IDR are RES0.

The power and reset domain of each MSC component is specific to that component.

Attributes

MPAMF_CSUMON_IDR is a 32-bit register.

Field descriptions

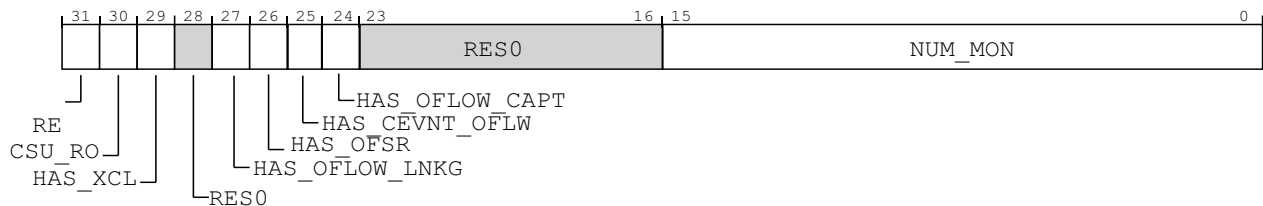

HAS_CAPTURE, bit [31]

The implementation supports copying an MSMON_CSU to the corresponding MSMON_CSU_CAPTURE on a capture event.

- 0b0 MSMON_CSU_CAPTURE is not implemented and there is no support for capture events in the CSU monitor.
- 0b1 The MSMON_CSU_CAPTURE register is implemented and the CSU monitor supports the capture event behavior.

If RIS is implemented, this field indicates that CSU monitor capture is implemented for the resource instance selected by MPAMCFG_PART_SEL.RIS.

CSU_RO, bit [30]

The implementation of MSMON_CSU is read-only.

- 0b0 MSMON_CSU is read/write.
- 0b1 MSMON_CSU is read-only.

If RIS is implemented, this field indicates that the MSMON_CSU monitor register is read-only for the resource instance selected by MPAMCFG_PART_SEL.RIS.

HAS_XCL, bit [29]

When FEAT_MPAMv0p1 is implemented or FEAT_MPAMv1p1 is implemented:

Has filtering to exclude clean data and implements the `MSMON_CFG_CSU_FLT.XCL` field.

0b0 `MSMON_CFG_CSU_FLT` does not implement the XCL field.

0b1 `MSMON_CFG_CSU_FLT` implements the XCL field to exclude counting data in the clean state in the monitor instance.

If RIS is implemented, this field indicates that the `MSMON_CFG_CSU_FLT.XCL` field is implemented in the CSU monitor instances for the resource instance selected by `MPAMCFG_PART_SEL.RIS`.

Otherwise:

Reserved, RES0.

Bit [28]

Reserved, RES0.

HAS_OFLOW_LNKG, bit [27]

When FEAT_MPAMv0p1 is implemented or FEAT_MPAMv1p1 is implemented:

Supports `MSMON_CFG_CSU_CTL.OFLOW_LNKG` field to control how overflow on an instance affects other monitor instances in this MSC.

0b0 Does not support CSU overflow linkage.

0b1 Supports CSU overflow linkage and the `MSMON_CFG_CSU_CTL.OFLOW_LNKG` field.

If RIS is implemented, this field indicates that `MSMON_CFG_CSU_CTL.OFLOW_LNKG` is implemented for the resource instance selected by `MPAMCFG_PART_SEL.RIS`.

Otherwise:

Reserved, RES0.

HAS_OFSR, bit [26]

When FEAT_MPAMv0p1 is implemented or FEAT_MPAMv1p1 is implemented:

The CSU monitor overflow status bitmap register, `MSMON_CSU_OFSR`, is implemented.

0b0 `MSMON_CSU_OFSR` register is not implemented.

0b1 `MSMON_CSU_OFSR` register is implemented.

If RIS is implemented, this field indicates that CSU monitor overflow status bitmap register is implemented for the resource instance selected by `MPAMCFG_PART_SEL.RIS`.

Otherwise:

Reserved, RES0.

HAS_CEVNT_OFLW, bit [25]

When FEAT_MPAMv0p1 is implemented or FEAT_MPAMv1p1 is implemented:

Supports `MSMON_CFG_CSU_CTL.CEVNT_OFLW` field which can enable the CSU monitor instance to perform overflow behaviors on a capture event.

0b0 Does not support `MSMON_CFG_CSU_CTL.CEVNT_OFLW`.

0b1 Supports `MSMON_CFG_CSU_CTL.CEVNT_OFLW`.

If RIS is implemented, this field indicates that `MSMON_CFG_CSU_CTL.CEVNT_OFLW` is implemented for the resource instance selected by `MPAMCFG_PART_SEL.RIS`.

Otherwise:

Reserved, RES0.

HAS_OFLOW_CAPT, bit [24]

When FEAT_MPAMv0p1 is implemented or FEAT_MPAMv1p1 is implemented:

Supports [MSMON_CFG_CSU_CTL.OFLOW_CAPT](#) field which can enable the CSU monitor instance to capture the monitor on an overflow.

0b0 Does not support [MSMON_CFG_CSU_CTL.OFLOW_CAPT](#).

0b1 Supports [MSMON_CFG_CSU_CTL.OFLOW_CAPT](#).

If RIS is implemented, this field indicates that [MSMON_CFG_CSU_CTL.OFLOW_CAPT](#) is implemented for the resource instance selected by [MPAMCFG_PART_SEL.RIS](#).

Otherwise:

Reserved, RES0.

Bits [23:16]

Reserved, RES0.

NUM_MON, bits [15:0]

The number of cache storage usage monitor instances implemented.

The largest [MSMON_CFG_MON_SEL.MON_SEL](#) value is NUM_MON minus 1.

If RIS is implemented, this field indicates the number of CSU monitor instances implemented for the resource instance selected by [MPAMCFG_PART_SEL.RIS](#).

Accessing the MPAMF_CSUMON_IDR:

This register is within the MPAM feature page memory frames. In a system that supports Secure, Non-secure, Root, and Realm memory maps, there must be MPAM feature pages in all four address maps.

MPAMF_CSUMON_IDR is read-only.

MPAMF_CSUMON_IDR must be readable from the Non-secure, Secure, Root, and Realm MPAM feature pages.

MPAMF_CSUMON_IDR is permitted to have the same contents when read from the Secure, Non-secure, Root, and Realm MPAM feature pages unless the register contents are different for the different versions:

- MPAMF_CSUMON_IDR_s is permitted to have either the same or different contents to MPAMF_CSUMON_IDR_ns, MPAMF_CSUMON_IDR_rt, or MPAMF_CSUMON_IDR_rl.
- MPAMF_CSUMON_IDR_ns is permitted to have either the same or different contents to MPAMF_CSUMON_IDR_rt or MPAMF_CSUMON_IDR_rl.
- MPAMF_CSUMON_IDR_rt is permitted to have either the same or different contents to MPAMF_CSUMON_IDR_rl.

There must be separate registers in the Secure (MPAMF_CSUMON_IDR_s), Non-secure (MPAMF_CSUMON_IDR_ns), Root (MPAMF_CSUMON_IDR_rt), and Realm (MPAMF_CSUMON_IDR_rl) MPAM feature pages.

When [MPAMF_IDR.HAS_RIS](#) is 1, MPAMF_CSUMON_IDR shows the configuration of cache storage usage monitoring for the cache resource instance selected by [MPAMCFG_PART_SEL.RIS](#). Fields that mention RIS in their field descriptions have values that track the implemented properties of the resource instance. Fields that do not mention RIS are constant across all resource instances.

Access to MPAMF_CSUMON_IDR is not affected by [MSMON_CFG_MON_SEL.RIS](#).

MPAMF_CSUMON_IDR can be accessed through its memory-mapped interface:

Component	Frame	Offset	Instance
MPAM	MPAMF_BASE_s	0x0088	MPAMF_CSUMON_IDR_s

Accesses to this interface are RO.

MPAMF_CSUMON_IDR can be accessed through its memory-mapped interface:

Component	Frame	Offset	Instance
MPAM	MPAMF_BASE_ns	0x0088	MPAMF_CSUMON_IDR_ns

Accesses to this interface are RO.

MPAMF_CSUMON_IDR can be accessed through its memory-mapped interface:

Component	Frame	Offset	Instance
MPAM	MPAMF_BASE_rt	0x0088	MPAMF_CSUMON_IDR_rt

When FEAT_RME is implemented, accesses to this interface are RO.

MPAMF_CSUMON_IDR can be accessed through its memory-mapped interface:

Component	Frame	Offset	Instance
MPAM	MPAMF_BASE_rl	0x0088	MPAMF_CSUMON_IDR_rl

When FEAT_RME is implemented, accesses to this interface are RO.

11.3.5 MPAMF_IDR, MPAM Features Identification Register

The MPAMF_IDR characteristics are:

Purpose

Indicates which memory partitioning and monitoring features are present on this MSC.

MPAMF_IDR_s indicates the MPAM features accessed from the Secure MPAM feature page.

MPAMF_IDR_ns indicates the MPAM features accessed from the Non-secure MPAM feature page.

MPAMF_IDR_rt indicates the MPAM features accessed from the Root MPAM feature page.

MPAMF_IDR_rl indicates the MPAM features accessed from the Realm MPAM feature page.

When MPAMF_IDR.HAS_RIS is 1, some fields in this register give information for the resource instance selected by MPAMCFG_PART_SEL.RIS. The description of every field that is affected by MPAMCFG_PART_SEL.RIS has that information within the field description.

Configurations

The power domain of MPAMF_IDR is IMPLEMENTATION DEFINED.

This register is present only when FEAT_MPAM is implemented. Otherwise, direct accesses to MPAMF_IDR are RES0.

MPAMF_IDR is 64-bit register when MPAM v0.1 or v1.1 is implemented.

Otherwise, MPAMF_IDR is a 32-bit register.

The power and reset domain of each MSC component is specific to that component.

Attributes

MPAMF_IDR is a:

- 64-bit register when FEAT_MPAMv0p1 is implemented or FEAT_MPAMv1p1 is implemented
- 32-bit register otherwise

Field descriptions

When FEAT_MPAMv0p1 is implemented or FEAT_MPAMv1p1 is implemented:

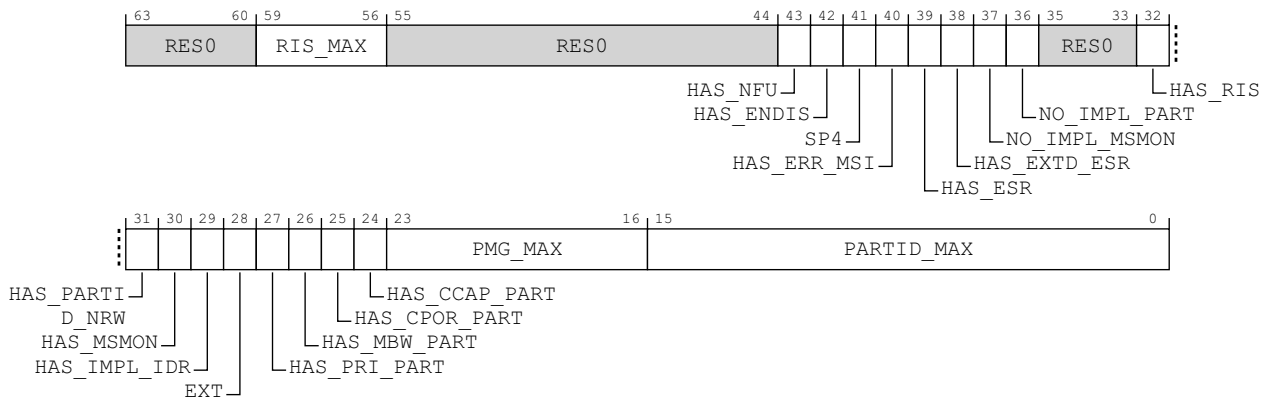

Bits [63:60]

Reserved, RES0.

RIS_MAX, bits [59:56]

When MPAMF_IDR.EXT == 1 and MPAMF_IDR.HAS_RIS == 1:

Maximum RIS value supported in MPAMCFG_PART_SEL. Must be 0b0000 if MPAMF_IDR.HAS_RIS == 0.

Otherwise:

Reserved, RES0.

Bits [55:44]

Reserved, RES0.

HAS_NFU, bit [43]

When FEAT_MPAMv1p1 is implemented or FEAT_MPAMv0p1 is implemented:

Has No Future Use field in [MPAMCFG_DIS](#). Indicates that [MPAMCFG_DIS.NFU](#) is implemented.

0b0 [MPAMCFG_DIS.NFU](#) is not implemented. A PARTID disabled through access to [MPAMCFG_DIS](#) must preserve the control settings of the disabled PARTID.

0b1 Implements [MPAMCFG_DIS.NFU](#). A PARTID disabled with NFU as 1 may have its control settings forgotten.

If [MPAMF_IDR.HAS_ENDIS](#) is 0b0, this field must also be 0b0.

This field must be the same in each instance of this register and for any value in [MPAMCFG_PART_SEL.RIS](#).

Otherwise:

Reserved, RES0.

HAS_ENDIS, bit [42]

When FEAT_MPAMv1p1 is implemented or FEAT_MPAMv0p1 is implemented:

Has PARTID enable and disable. Indicates that this MSC supports PARTID disable and enable via [MPAMCFG_DIS](#), [MPAMCFG_EN](#) and [MPAMCFG_EN_FLAGS](#) registers.

0b0 Does not support PARTID enable and disable functionality, and [MPAMCFG_EN](#), [MPAMCFG_DIS](#) and [MPAMCFG_EN_FLAGS](#) registers are not implemented.

0b1 Supports PARTID enable and disable through the [MPAMCFG_EN](#), [MPAMCFG_DIS](#) and [MPAMCFG_EN_FLAGS](#) registers.

All three registers must be implemented when this field is 1, [MPAMCFG_EN](#), [MPAMCFG_DIS](#), and [MPAMCFG_EN_FLAGS](#).

This field must be the same in each instance of this register and for any value in [MPAMCFG_PART_SEL.RIS](#).

Otherwise:

Reserved, RES0.

SP4, bit [41]

When FEAT_RME is implemented:

Indicates whether this MSC supports 4 PARTID spaces.

0b0 This MSC supports two PARTID spaces.

0b1 This MSC supports four PARTID spaces.

This field must read the same in each instance of this register and for any value in [MPAMCFG_PART_SEL.RIS](#).

Otherwise:

Reserved, RES0.

HAS_ERR_MSI, bit [40]

When MPAMF_IDR.EXT == 1:

Has support for MSI writes to signal MPAM error interrupts. These registers are implemented: [MPAMF_ERR_MSI_ADDR_L](#), [MPAMF_ERR_MSI_ADDR_H](#), [MPAMF_ERR_MSI_ATTR](#), [MPAMF_ERR_MSI_DATA](#), and [MPAMF_ERR_MSI_MPAM](#).

0b0 [MPAMF_ERR_MSI_ADDR_L](#), [MPAMF_ERR_MSI_ADDR_H](#), [MPAMF_ERR_MSI_ATTR](#), [MPAMF_ERR_MSI_DATA](#), and [MPAMF_ERR_MSI_MPAM](#) registers are not implemented.

0b1 [MPAMF_ERR_MSI_ADDR_L](#), [MPAMF_ERR_MSI_ADDR_H](#), [MPAMF_ERR_MSI_ATTR](#), [MPAMF_ERR_MSI_DATA](#), and [MPAMF_ERR_MSI_MPAM](#) are implemented and can be used to generate writes to signal error interrupts.

If [MPAMF_IDR.HAS_ESR](#) is 0, this bit must also be 0.

Otherwise:

Reserved, RES0.

HAS_ESR, bit [39]

When MPAMF_IDR.EXT == 1:

[MPAMF_ESR](#) is implemented.

0b0 [MPAMF_ESR](#), [MPAMF_ECR](#), and MPAM error handling are not implemented.

0b1 [MPAMF_ESR](#), [MPAMF_ECR](#), and MPAM error handling are implemented.

If an MSC cannot encounter any of the error conditions listed in [Errors in MSCs](#), both the [MPAMF_ESR](#) and [MPAMF_ECR](#) must be RAZ/WI.

Otherwise:

Reserved, RES0.

HAS_EXTD_ESR, bit [38]

When MPAMF_IDR.EXT == 1:

[MPAMF_ESR](#) is 64 bits.

0b0 [MPAMF_ESR](#) is 32 bits.

0b1 [MPAMF_ESR](#) is 64 bits.

When [MPAMF_IDR.HAS_RIS](#) and [MPAMF_IDR.HAS_ESR](#), this field must be 1.

Otherwise:

Reserved, RES0.

NO_IMPL_MSMON, bit [37]

When MPAMF_IDR.EXT == 1 and MPAMF_IDR.HAS_IMPL_IDR == 1:

[MPAMF_IMPL_IDR](#) defines no IMPLEMENTATION DEFINED resource monitors.

0b0 [MPAMF_IMPL_IDR](#) defines at least one IMPLEMENTATION DEFINED resource monitor.

0b1 [MPAMF_IMPL_IDR](#) does not define any IMPLEMENTATION DEFINED resource monitors.

If RIS is implemented, this field indicates the presence of IMPLEMENTATION DEFINED resource monitors described in [MPAMF_IMPL_IDR](#) for the selected resource instance.

Otherwise:

Reserved, RES0.

NO_IMPL_PART, bit [36]

When MPAMF_IDR.EXT == 1 and MPAMF_IDR.HAS_IMPL_IDR == 1:

MPAMF_IMPL_IDR defines no IMPLEMENTATION DEFINED resource controls.

0b0 MPAMF_IMPL_IDR defines at least one IMPLEMENTATION DEFINED resource control.

0b1 MPAMF_IMPL_IDR does not define any IMPLEMENTATION DEFINED resource controls.

If RIS is implemented, this field indicates the presence of IMPLEMENTATION DEFINED resource controls described in MPAMF_IMPL_IDR for the selected resource instance.

Otherwise:

Reserved, RES0.

Bits [35:33]

Reserved, RES0.

HAS_RIS, bit [32]

When MPAMF_IDR.EXT == 1:

Has resource instance selector. Indicates that MPAMCFG_PART_SEL contains the RIS field that selects a resource instance to control.

0b0 MPAMCFG_PART_SEL does not implement the MPAMCFG_PART_SEL.RIS field or multiple resource instance support.

0b1 MPAMCFG_PART_SEL implements the MPAMCFG_PART_SEL.RIS field and MPAM resource instance numbers up to and including MPAMF_IDR.RIS_MAX.

Otherwise:

Reserved, RES0.

HAS_PARTID_NRW, bit [31]

Has PARTID narrowing.

0b0 Does not have MPAMF_PARTID_NRW_IDR, MPAMCFG_INTPARTID, or intPARTID mapping support.

0b1 Supports the MPAMF_PARTID_NRW_IDR, MPAMCFG_INTPARTID registers.

HAS_MSMON, bit [30]

Has resource Monitors. Indicates whether this MSC has MPAM resource monitors.

0b0 Does not support MPAM resource monitoring by groups or MPAMF_MSMON_IDR.

0b1 Supports resource monitoring by matching a combination of PARTID and PMG. See MPAMF_MSMON_IDR.

HAS_IMPL_IDR, bit [29]

Has MPAMF_IMPL_IDR. Indicates whether this MSC has the IMPLEMENTATION SPECIFIC MPAM features register, MPAMF_IMPL_IDR.

0b0 Does not have MPAMF_IMPL_IDR.

0b1 Has MPAMF_IMPL_IDR.

EXT, bit [28]

When FEAT_MPAMv0p1 is implemented or FEAT_MPAMv1p1 is implemented:

Extended MPAMF_IDR.

0b0 MPAMF_IDR has no defined bits in [63:32]. The register is effectively 32 bits.

0b1 MPAMF_IDR has bits defined in [63:32]. The register is 64-bits.

Otherwise:

Reserved, RES0.

HAS_PRI_PART, bit [27]

Has Priority Partitioning. Indicates that MPAM priority partitioning is implemented and [MPAMF_PRI_IDR](#) exists.

0b0 Does not support priority partitioning or have [MPAMF_PRI_IDR](#).

0b1 Has priority partitioning and [MPAMF_PRI_IDR](#).

If RIS is implemented, this field indicates the presence of priority partitioning resource controls as described in [MPAMF_PRI_IDR](#) for the selected resource instance.

HAS_MBW_PART, bit [26]

Has Memory Bandwidth Partitioning. Indicates whether this MSC implements MPAM memory bandwidth partitioning and [MPAMF_MBW_IDR](#).

0b0 Does not support memory bandwidth partitioning or have [MPAMF_MBW_IDR](#) register.

0b1 Has [MPAMF_MBW_IDR](#) register.

If RIS is implemented, this field indicates the presence of memory bandwidth partitioning resource controls as described in [MPAMF_MBW_IDR](#) for the selected resource instance.

HAS_CPOR_PART, bit [25]

Has Cache Portion Partitioning. Indicates whether this MSC implements MPAM cache portion partitioning and [MPAMF_CPOR_IDR](#).

0b0 Does not support cache portion partitioning or have [MPAMF_CPOR_IDR](#) or [MPAMCFG_CPBM<n>](#) registers.

0b1 Has [MPAMF_CPOR_IDR](#) and [MPAMCFG_CPBM<n>](#) registers.

If RIS is implemented, this field indicates the presence of cache portion partitioning resource controls as described in [MPAMF_CPOR_IDR](#) for the selected resource instance.

HAS_CCAP_PART, bit [24]

Has Cache Capacity Partitioning. Indicates whether this MSC implements MPAM cache capacity partitioning and the [MPAMF_CCAP_IDR](#) and [MPAMCFG_CMAX](#) registers.

0b0 Does not support cache capacity partitioning or have [MPAMF_CCAP_IDR](#) and [MPAMCFG_CMAX](#) registers.

0b1 Has [MPAMF_CCAP_IDR](#) and [MPAMCFG_CMAX](#) registers.

If RIS is implemented, this field indicates the presence of cache capacity partitioning resource controls as described in [MPAMF_CPOR_IDR](#) for the selected resource instance.

PMG_MAX, bits [23:16]

Maximum supported value of PMG.

The value of this field is permitted to vary between the instances of [MPAMF_IDR](#), each reporting the maximum supported PMG value in the PARTID space associated with that instance.

In [MPAMF_IDR_s](#), this field is permitted to report the maximum PMG value for the Non-secure PARTID space or for the Secure PARTID space. The maximum PMG value for the Secure PARTID space can be read from [MPAMF_SIDR.PMG_MAX](#).

PARTID_MAX, bits [15:0]

Maximum supported value of PARTID.

The value of this field is permitted to vary between the instances of [MPAMF_IDR](#), each reporting the maximum supported PARTID value in the PARTID space associated with that instance.

In [MPAMF_IDR_s](#), this field is permitted to report the maximum PARTID value for the Non-secure PARTID space or for the Secure PARTID space. The maximum PARTID value for the Secure PARTID space can be read from [MPAMF_SIDR.PARTID_MAX](#).

Otherwise:

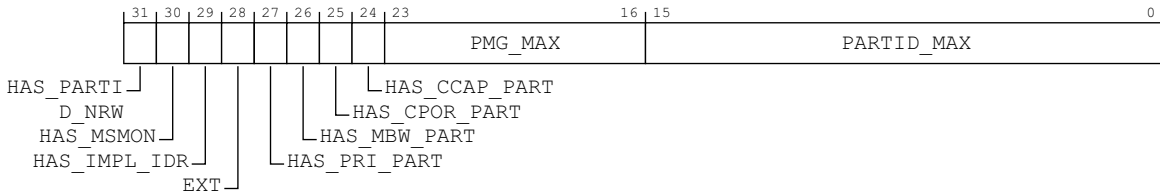

HAS_PARTID_NRW, bit [31]

Has PARTID Narrowing.

- 0b0 Does not have [MPAMF_PARTID_NRW_IDR](#), [MPAMCFG_INTPARTID](#), or [intPARTID](#) mapping support.
- 0b1 Supports the [MPAMF_PARTID_NRW_IDR](#), [MPAMCFG_INTPARTID](#) registers.

HAS_MSMON, bit [30]

Has resource Monitors. Indicates whether this MSC has MPAM resource monitors.

- 0b0 Does not support MPAM resource monitoring by groups or [MPAMF_MSMON_IDR](#).
- 0b1 Supports resource monitoring by matching a combination of PARTID and PMG. See [MPAMF_MSMON_IDR](#).

HAS_IMPL_IDR, bit [29]

Has [MPAMF_IMPL_IDR](#). Indicates whether this MSC has the IMPLEMENTATION SPECIFIC MPAM features register, [MPAMF_IMPL_IDR](#).

- 0b0 Does not have [MPAMF_IMPL_IDR](#).
- 0b1 Has [MPAMF_IMPL_IDR](#).

EXT, bit [28]

When FEAT_MPAMv0p1 is implemented or FEAT_MPAMv1p1 is implemented:

Extended [MPAMF_IDR](#).

- 0b0 [MPAMF_IDR](#) has no defined bits in [63:32]. The register is effectively 32 bits.
- 0b1 [MPAMF_IDR](#) has bits defined in [63:32]. The register is 64-bits.

Otherwise:

Reserved, RES0.

HAS_PRI_PART, bit [27]

Has Priority Partitioning. Indicates whether this MSC implements MPAM priority partitioning and [MPAMF_PRI_IDR](#).

- 0b0 Does not support priority partitioning or have [MPAMF_PRI_IDR](#).
- 0b1 Has [MPAMF_PRI_IDR](#).

HAS_MBW_PART, bit [26]

Has Memory Bandwidth Partitioning. Indicates whether this MSC implements MPAM memory bandwidth partitioning and [MPAMF_MBW_IDR](#).

- 0b0 Does not support memory bandwidth partitioning or have [MPAMF_MBW_IDR](#) register.
- 0b1 Has [MPAMF_MBW_IDR](#) register.

HAS_CPOR_PART, bit [25]

Has Cache Portion Partitioning. Indicates whether this MSC implements MPAM cache portion partitioning and [MPAMF_CPOR_IDR](#).

- 0b0 Does not support cache portion partitioning or have [MPAMF_CPOR_IDR](#) or [MPAMCFG_CPBM<n>](#) registers.
- 0b1 Has [MPAMF_CPOR_IDR](#) and [MPAMCFG_CPBM<n>](#) registers.

HAS_CCAP_PART, bit [24]

Has Cache Capacity Partitioning. Indicates whether this MSC implements MPAM cache capacity partitioning and the [MPAMF_CCAP_IDR](#) and [MPAMCFG_CMAX](#) registers.

- 0b0 Does not support cache capacity partitioning or have [MPAMF_CCAP_IDR](#) and [MPAMCFG_CMAX](#) registers.
- 0b1 Has [MPAMF_CCAP_IDR](#) and [MPAMCFG_CMAX](#) registers.

PMG_MAX, bits [23:16]

Maximum supported value of PMG.

The value of this field is permitted to vary between the instances of [MPAMF_IDR](#), each reporting the maximum supported PMG value in the PARTID space associated with that instance.

In [MPAMF_IDR_s](#) this field is permitted to report the maximum PMG value for the Non-secure PARTID space or for the Secure PARTID space. The maximum PMG value for the Secure PARTID space can be read from [MPAMF_SIDR.PMG_MAX](#).

PARTID_MAX, bits [15:0]

Maximum supported value of PARTID.

The value of this field is permitted to vary between the instances of [MPAMF_IDR](#), each reporting the maximum supported PARTID value in the PARTID space associated with that instance.

In [MPAMF_IDR_s](#) this field is permitted to report the maximum PARTID value for the Non-secure PARTID space or for the Secure PARTID space. The maximum PARTID value for the Secure PARTID space can be read from [MPAMF_SIDR.PARTID_MAX](#).

Accessing the MPAMF_IDR:

This register is within the MPAM feature page memory frames. In a system that supports Secure, Non-secure, Root, and Realm memory maps, there must be MPAM feature pages in all four address maps.

[MPAMF_IDR](#) is read-only.

[MPAMF_IDR](#) must be readable from the Non-secure, Secure, Root, and Realm MPAM feature pages.

[MPAMF_IDR](#) is permitted to have the same contents when read from the Secure, Non-secure, Root, and Realm MPAM feature pages unless the register contents are different for the different versions:

- [MPAMF_IDR_s](#) is permitted to have either the same or different contents to [MPAMF_IDR_ns](#), [MPAMF_IDR_rt](#), or [MPAMF_IDR_rl](#).
- [MPAMF_IDR_ns](#) is permitted to have either the same or different contents to [MPAMF_IDR_rt](#) or [MPAMF_IDR_rl](#).
- [MPAMF_IDR_rt](#) is permitted to have either the same or different contents to [MPAMF_IDR_rl](#).

There must be separate registers in the Secure ([MPAMF_IDR_s](#)), Non-secure ([MPAMF_IDR_ns](#)), Root ([MPAMF_IDR_rt](#)), and Realm ([MPAMF_IDR_rl](#)) MPAM feature pages.

When [MPAMF_IDR.HAS_RIS](#) is 1, [MPAMF_IDR](#) shows the configuration of MSC MPAM for the resource instance selected by [MPAMCFG_PART_SEL.RIS](#). Fields that mention RIS in their field descriptions have values that track the implemented properties of the resource instance. Fields that do not mention RIS are constant across all resource instances.

MPAMF_IDR can be accessed through its memory-mapped interface:

Component	Frame	Offset	Instance
MPAM	MPAMF_BASE_s	0x0000	MPAMF_IDR_s

Accesses to this interface are RO.

MPAMF_IDR can be accessed through its memory-mapped interface:

Component	Frame	Offset	Instance
MPAM	MPAMF_BASE_ns	0x0000	MPAMF_IDR_ns

Accesses to this interface are RO.

MPAMF_IDR can be accessed through its memory-mapped interface:

Component	Frame	Offset	Instance
MPAM	MPAMF_BASE_rt	0x0000	MPAMF_IDR_rt

When FEAT_RME is implemented, accesses to this interface are RO.

MPAMF_IDR can be accessed through its memory-mapped interface:

Component	Frame	Offset	Instance
MPAM	MPAMF_BASE_rl	0x0000	MPAMF_IDR_rl

When FEAT_RME is implemented, accesses to this interface are RO.

11.3.6 MPAMF_IIDR, MPAM Implementation Identification Register

The MPAMF_IIDR characteristics are:

Purpose

Uniquely identifies the MSC implementation by the combination of implementer, product ID, variant, and revision.

Configurations

The power domain of MPAMF_IIDR is IMPLEMENTATION DEFINED.

This register is present only when FEAT_MPAM is implemented. Otherwise, direct accesses to MPAMF_IIDR are RES0.

The power and reset domain of each MSC component is specific to that component.

Attributes

MPAMF_IIDR is a 32-bit register.

Field descriptions

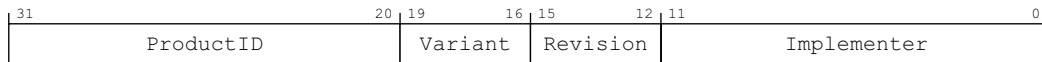

ProductID, bits [31:20]

The MSC implementer as identified in the MPAMF_IIDR.Implementer field must assure each product has a unique ProductID from any other with the same Implementer value.

This field has an IMPLEMENTATION DEFINED value.

Access to this field is RO.

Variant, bits [19:16]

This field distinguishes product variants or major revisions of the product.

———— **Note** ————

Implementations of ProductID with differing software interfaces are expected to have different values in the MPAMF_IIDR.Variant field.

This field has an IMPLEMENTATION DEFINED value.

Access to this field is RO.

Revision, bits [15:12]

This field distinguishes minor revisions of the product.

———— **Note** ————

This field is intended to differentiate product revisions that are minor changes and are largely software compatible with previous revisions.

This field has an IMPLEMENTATION DEFINED value.

Access to this field is RO.

Implementer, bits [11:0]

Contains the JEP106 code of the company that implemented the MPAM MSC.

[11:8] must contain the JEP106 continuation code of the implementer.

[7] must always be 0.

[6:0] must contain the JEP106 identity code of the implementer.
For an Arm implementation, bits[11:0] are 0x43B.

Accessing the MPAMF_IIDR:

This register is within the MPAM feature page memory frames.

In a system that supports Secure, Non-secure, Root, and Realm memory maps, there must be MPAM feature pages in all four address maps.

MPAMF_IIDR is read-only.

MPAMF_IIDR must be readable from the Secure, Non-secure, Root, and Realm MPAM feature pages.

MPAMF_IIDR must have the same contents in the Secure, Non-secure, Root, and Realm MPAM feature pages.

MPAMF_IIDR can be accessed through its memory-mapped interface:

Component	Frame	Offset	Instance
MPAM	MPAMF_BASE_s	0x0018	MPAMF_IIDR_s

Accesses to this interface are RO.

MPAMF_IIDR can be accessed through its memory-mapped interface:

Component	Frame	Offset	Instance
MPAM	MPAMF_BASE_ns	0x0018	MPAMF_IIDR_ns

Accesses to this interface are RO.

MPAMF_IIDR can be accessed through its memory-mapped interface:

Component	Frame	Offset	Instance
MPAM	MPAMF_BASE_rt	0x0018	MPAMF_IIDR_rt

When FEAT_RME is implemented, accesses to this interface are RO.

MPAMF_IIDR can be accessed through its memory-mapped interface:

Component	Frame	Offset	Instance
MPAM	MPAMF_BASE_rl	0x0018	MPAMF_IIDR_rl

When FEAT_RME is implemented, accesses to this interface are RO.

11.3.7 MPAMF_IMPL_IDR, MPAM Implementation-Specific Partitioning Feature Identification Register

The MPAMF_IMPL_IDR characteristics are:

Purpose

Indicates the implementation-defined partitioning and monitoring features and parameters of the MSC.

MPAMF_IMPL_IDR_s indicates IMPLEMENTATION DEFINED partitioning and monitoring features accessed from the Secure MPAM feature page. MPAMF_IMPL_IDR_ns indicates those accessed from the Non-secure MPAM feature page. MPAMF_IMPL_IDR_rt indicates IMPLEMENTATION DEFINED partitioning and monitoring features accessed from the Root MPAM feature page. MPAMF_IMPL_IDR_rl indicates those accessed from the Realm MPAM feature page.

If [MPAMF_IDR.HAS_RIS](#) is 1, this register gives the implementation-specific features and parameters of the resource instance selected by [MPAMCFG_PART_SEL.RIS](#) for any features that are specific to the resource.

Configurations

The power domain of MPAMF_IMPL_IDR is IMPLEMENTATION DEFINED.

This register is present only when FEAT_MPAM is implemented and [MPAMF_IDR.HAS_IMPL_IDR](#) == 1. Otherwise, direct accesses to MPAMF_IMPL_IDR are RES0.

The power and reset domain of each MSC component is specific to that component.

Attributes

MPAMF_IMPL_IDR is a 32-bit register.

Field descriptions



IMPLFEAT, bits [31:0]

All 32 bits of this register are available to be used as the implementer sees fit to indicate the presence of IMPLEMENTATION DEFINED MPAM features in this MSC and to give additional implementation-specific read-only information about the parameters of implementation-specific MPAM features to software.

If RIS is implemented, this register indicates the implementation-specific features and parameters of the resource instance selected by [MPAMCFG_PART_SEL.RIS](#).

Accessing the MPAMF_IMPL_IDR:

This register is within the MPAM feature page memory frames. In a system that supports Secure, Non-secure, Root, and Realm memory maps, there must be MPAM feature pages in all four address maps.

MPAMF_IMPL_IDR is read-only.

MPAMF_IMPL_IDR must be readable from the Non-secure, Secure, Root, and Realm MPAM feature pages.

MPAMF_IMPL_IDR is permitted to have the same contents when read from the Secure, Non-secure, Root, and Realm MPAM feature pages unless the register contents are different for the different versions:

- MPAMF_IMPL_IDR_s is permitted to have either the same or different contents to MPAMF_IMPL_IDR_ns, MPAMF_IMPL_IDR_rt, or MPAMF_IMPL_IDR_rl.
- MPAMF_IMPL_IDR_ns is permitted to have either the same or different contents to MPAMF_IMPL_IDR_rt or MPAMF_IMPL_IDR_rl.

- MPAMF_IMPL_IDR_rt is permitted to have either the same or different contents to MPAMF_IMPL_IDR_rl.

There must be separate registers in the Secure (MPAMF_IMPL_IDR_s), Non-secure (MPAMF_IMPL_IDR_ns), Root (MPAMF_IMPL_IDR_rt), and Realm (MPAMF_IMPL_IDR_rl) MPAM feature pages.

When MPAMF_IDR.HAS_RIS is 1, MPAMF_IMPL_IDR shows the configuration of implementation-specific features for the resource instance selected by MPAMCFG_PART_SEL.RIS. Fields that mention RIS in their field descriptions have values that track the implemented properties of the resource instance. Fields that do not mention RIS are constant across all resource instances.

MPAMF_IMPL_IDR can be accessed through its memory-mapped interface:

Component	Frame	Offset	Instance
MPAM	MPAMF_BASE_s	0x0028	MPAMF_IMPL_IDR_s

Accesses to this interface are RO.

MPAMF_IMPL_IDR can be accessed through its memory-mapped interface:

Component	Frame	Offset	Instance
MPAM	MPAMF_BASE_ns	0x0028	MPAMF_IMPL_IDR_ns

Accesses to this interface are RO.

MPAMF_IMPL_IDR can be accessed through its memory-mapped interface:

Component	Frame	Offset	Instance
MPAM	MPAMF_BASE_rt	0x0028	MPAMF_IMPL_IDR_rt

When FEAT_RME is implemented, accesses to this interface are RO.

MPAMF_IMPL_IDR can be accessed through its memory-mapped interface:

Component	Frame	Offset	Instance
MPAM	MPAMF_BASE_rl	0x0028	MPAMF_IMPL_IDR_rl

When FEAT_RME is implemented, accesses to this interface are RO.

11.3.8 MPAMF_MBW_IDR, MPAM Memory Bandwidth Partitioning Identification Register

The MPAMF_MBW_IDR characteristics are:

Purpose

Indicates which MPAM bandwidth partitioning features are present on this MSC.

MPAMF_MBW_IDR_s indicates bandwidth partitioning features accessed from the Secure MPAM feature page. MPAMF_MBW_IDR_ns indicates bandwidth partitioning features accessed from the Non-secure MPAM feature page. MPAMF_MBW_IDR_rt indicates bandwidth partitioning features accessed from the Root MPAM feature page. MPAMF_MBW_IDR_rl indicates bandwidth partitioning features accessed from the Realm MPAM feature page.

When MPAMF_IDR.HAS_RIS is 1, some fields in this register give information for the resource instance selected by MPAMCFG_PART_SEL.RIS. The description of every field that is affected by MPAMCFG_PART_SEL.RIS has that information within the field description.

Configurations

The power domain of MPAMF_MBW_IDR is IMPLEMENTATION DEFINED.

This register is present only when FEAT_MPAM is implemented and MPAMF_IDR.HAS_MBW_PART == 1. Otherwise, direct accesses to MPAMF_MBW_IDR are RES0.

The power and reset domain of each MSC component is specific to that component.

Attributes

MPAMF_MBW_IDR is a 32-bit register.

Field descriptions

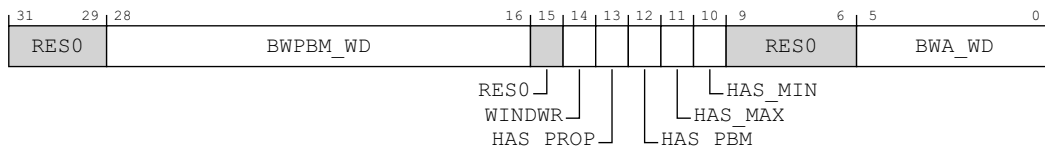

Bits [31:29]

Reserved, RES0.

BWPBM_WD, bits [28:16]

Bandwidth portion bitmap width.

The number of bandwidth portion bits in the MPAMCFG_MBW_PBM<n> register array.

If MPAMF_MBW_IDR.HAS_PBM is 1, this field must contain a value from 1 to 4096, inclusive. Values greater than 32 require a group of 32-bit registers to access the BWPBM, up to 128 if BWPBM_WD is the largest value.

If MPAMF_MBW_IDR.HAS_PBM is 0, this field must be ignored by software.

If RIS is implemented, this field indicates the width of the memory bandwidth portion bitmap partitioning control for the resource instance selected by MPAMCFG_PART_SEL.RIS.

Bit [15]

Reserved, RES0.

WINDWR, bit [14]

Indicates the bandwidth accounting period register is writable.

- 0b0 The bandwidth accounting period is readable from [MPAMCFG_MBW_WINWD](#) which might be fixed or vary due to clock rate reconfiguration of the memory channel or memory controller.
- 0b1 The bandwidth accounting width is readable and writable per partition in [MPAMCFG_MBW_WINWD](#).

HAS_PROP, bit [13]

Indicates that this MSC implements proportional stride bandwidth partitioning and the [MPAMCFG_MBW_PROP](#) register can be accessed.

- 0b0 There is no memory bandwidth proportional stride control and the [MPAMCFG_MBW_PROP](#) register is RES0.
- 0b1 The proportional stride memory bandwidth partitioning scheme is supported and the [MPAMCFG_MBW_PROP](#) register can be accessed.

If RIS is implemented, this field indicates the presence of the memory bandwidth proportional stride partitioning control for the resource instance selected by [MPAMCFG_PART_SEL](#).RIS.

HAS_PBM, bit [12]

Indicates that bandwidth portion partitioning is implemented and the [MPAMCFG_MBW_PBM<n>](#) register array can be accessed.

- 0b0 There is no memory bandwidth portion control and the [MPAMCFG_MBW_PBM<n>](#) is RES0.
- 0b1 The memory bandwidth portion allocation scheme exists and the [MPAMCFG_MBW_PBM<n>](#) register can be accessed.

If RIS is implemented, this field indicates the presence of the memory bandwidth portion partitioning control for the resource instance selected by [MPAMCFG_PART_SEL](#).RIS.

HAS_MAX, bit [11]

Indicates that this MSC implements maximum bandwidth partitioning and the [MPAMCFG_MBW_MAX](#) register can be accessed.

- 0b0 There is no maximum memory bandwidth control and the [MPAMCFG_MBW_MAX](#) register is RES0.
- 0b1 The maximum memory bandwidth allocation scheme is supported and the [MPAMCFG_MBW_MAX](#) register can be accessed.

If RIS is implemented, this field indicates the presence of the maximum bandwidth partitioning control for the resource instance selected by [MPAMCFG_PART_SEL](#).RIS.

HAS_MIN, bit [10]

Indicates that this MSC implements minimum bandwidth partitioning and the [MPAMCFG_MBW_MIN](#) register can be accessed.

- 0b0 There is no minimum memory bandwidth control and the [MPAMCFG_MBW_MIN](#) register is RES0.
- 0b1 The minimum memory bandwidth allocation scheme is supported and the [MPAMCFG_MBW_MIN](#) register can be accessed.

If RIS is implemented, this field indicates the presence of the minimum bandwidth partitioning control for the resource instance selected by [MPAMCFG_PART_SEL](#).RIS.

Bits [9:6]

Reserved, RES0.

BWA_WD, bits [5:0]

Number of implemented bits in the bandwidth allocation fields: MIN, MAX, and STRIDE. See [MPAMCFG_MBW_MIN](#), [MPAMCFG_MBW_MAX](#), and [MPAMCFG_MBW_PROP](#).

In any of these bandwidth allocation fields exist, this field must have a value from 1 to 16, inclusive. Otherwise, it is permitted to be 0.

If RIS is implemented, this field indicates the number of implemented bits in the bandwidth allocation control fields for the resource instance selected by [MPAMCFG_PART_SEL](#).RIS.

Accessing the MPAMF_MBW_IDR:

This register is within the MPAM feature page memory frames. In a system that supports Secure, Non-secure, Root, and Realm memory maps, there must be MPAM feature pages in all four address maps.

MPAMF_MBW_IDR is read-only.

MPAMF_MBW_IDR must be readable from the Non-secure, Secure, Root, and Realm MPAM feature pages.

MPAMF_MBW_IDR is permitted to have the same contents when read from the Secure, Non-secure, Root, and Realm MPAM feature pages unless the register contents are different for the different versions:

- MPAMF_MBW_IDR_s is permitted to have either the same or different contents to MPAMF_MBW_IDR_ns, MPAMF_MBW_IDR_rt, or MPAMF_MBW_IDR_rl.
- MPAMF_MBW_IDR_ns is permitted to have either the same or different contents to MPAMF_MBW_IDR_rt or MPAMF_MBW_IDR_rl.
- MPAMF_MBW_IDR_rt is permitted to have either the same or different contents to MPAMF_MBW_IDR_rl.

There must be separate registers in the Secure (MPAMF_MBW_IDR_s), Non-secure (MPAMF_MBW_IDR_ns), Root (MPAMF_MBW_IDR_rt), and Realm (MPAMF_MBW_IDR_rl) MPAM feature pages.

When [MPAMF_IDR.HAS_RIS](#) is 1, MPAMF_MBW_IDR shows the configuration of memory bandwidth partitioning for the bandwidth resource instance selected by [MPAMCFG_PART_SEL](#).RIS. Fields that mention RIS in their field descriptions have values that track the implemented properties of the resource instance. Fields that do not mention RIS are constant across all resource instances.

MPAMF_MBW_IDR can be accessed through its memory-mapped interface:

Component	Frame	Offset	Instance
MPAM	MPAMF_BASE_s	0x0040	MPAMF_MBW_IDR_s

Accesses to this interface are RO.

MPAMF_MBW_IDR can be accessed through its memory-mapped interface:

Component	Frame	Offset	Instance
MPAM	MPAMF_BASE_ns	0x0040	MPAMF_MBW_IDR_ns

Accesses to this interface are RO.

MPAMF_MBW_IDR can be accessed through its memory-mapped interface:

Component	Frame	Offset	Instance
MPAM	MPAMF_BASE_rt	0x0040	MPAMF_MBW_IDR_rt

When FEAT_RME is implemented, accesses to this interface are RO.

MPAMF_MBW_IDR can be accessed through its memory-mapped interface:

Component	Frame	Offset	Instance
MPAM	MPAMF_BASE_r1	0x0040	MPAMF_MBW_IDR_r1

When FEAT_RME is implemented, accesses to this interface are RO.

11.3.9 MPAMF_MBWUMON_IDR, MPAM Features Memory Bandwidth Usage Monitoring ID register

The MPAMF_MBWUMON_IDR characteristics are:

Purpose

Indicates the number of memory bandwidth usage monitor instances implemented. This register also indicates several properties of MBWU monitoring, including whether the implementation supports capture, scaling, or long counters.

MPAMF_MBWUMON_IDR_s indicates the number of Secure memory bandwidth usage monitor instances. MPAMF_MBWUMON_IDR_ns indicates the number of Non-secure memory bandwidth usage monitor instances. MPAMF_MBWUMON_IDR_rt indicates the number of Root memory bandwidth usage monitor instances. MPAMF_MBWUMON_IDR_rl indicates the number of Realm memory bandwidth usage monitor instances.

If MPAMF_IDR.HAS_RIS is 1, fields that mention RIS must reflect the properties of the resource instance currently selected by MPAMCFG_PART_SEL.RIS. Fields that do not mention RIS are constant across all resource instances.

Configurations

The power domain of MPAMF_MBWUMON_IDR is IMPLEMENTATION DEFINED.

This register is present only when FEAT_MPAM is implemented, MPAMF_IDR.HAS_MSMON == 1 and MPAMF_MSMON_IDR.MSMON_MBWU == 1. Otherwise, direct accesses to MPAMF_MBWUMON_IDR are RES0.

The power and reset domain of each MSC component is specific to that component.

Attributes

MPAMF_MBWUMON_IDR is a 32-bit register.

Field descriptions

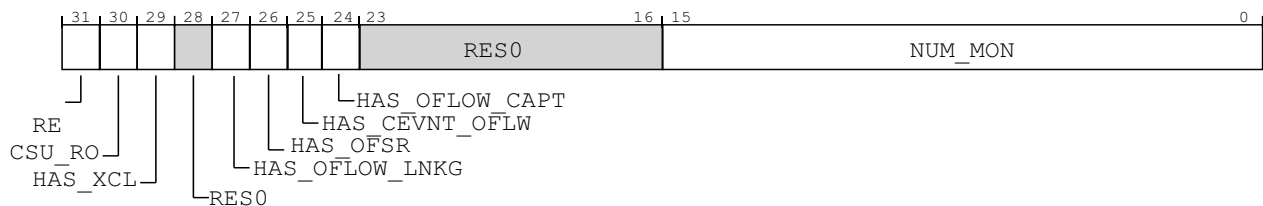

HAS_CAPTURE, bit [31]

The implementation supports copying an MSMON_MBWU to the corresponding MSMON_MBWU_CAPTURE on a capture event.

0b0 MSMON_MBWU_CAPTURE is not implemented and there is no support for capture events in the MBWU monitor.

0b1 The MSMON_MBWU_CAPTURE register is implemented and the MBWU monitor supports the capture event behavior.

If RIS is implemented, this field indicates that MBWU monitor capture is implemented for the resource instance selected by MPAMCFG_PART_SEL.RIS.

If MPAMF_MBWUMON_IDR.HAS_LONG is 1, this also indicates that MSMON_MBWU_L_CAPTURE is implemented.

HAS_LONG, bit [30]

When FEAT_MPAMv0p1 is implemented or FEAT_MPAMv1p1 is implemented:

Indicates whether MSMON_MBWU_L is implemented.

If HAS_CAPTURE is 1, indicates whether MSMON_MBWU_L_CAPTURE is implemented.

0b0 Does not implement MSMON_MBWU_L or MSMON_MBWU_L_CAPTURE.

0b1 Implements [MSMON_MBWU_L](#). If [HAS_CAPTURE](#) == 1, [MSMON_MBWU_L_CAPTURE](#) is also implemented.

If RIS is implemented, this field indicates that the long MBWU monitor is implemented for the resource instance selected by [MPAMCFG_PART_SEL.RIS](#).

If [MPAMF_MBWUMON_IDR.HAS_CAPTURE](#) is 1, this also indicates that [MSMON_MBWU_L_CAPTURE](#) is implemented.

Otherwise:

Reserved, RES0.

LWD, bit [29]

When [FEAT_MPAMv0p1](#) is implemented or [FEAT_MPAMv1p1](#) is implemented:

Long register VALUE width.

If [MPAMF_MBWUMON_IDR.HAS_LONG](#) is 0, [MPAMF_MBWUMON_IDR.LWD](#) must also be 0.

0b0 If [MPAMF_MBWUMON_IDR.HAS_LONG](#) is 1, [MSMON_MBWU_L](#) has 44-bit VALUE field in bits [43:0]. Bits [62:44] are RES0. If [HAS_LONG](#) is 1 and [MPAMF_MBWUMON_IDR.HAS_CAPTURE](#) is 1, [MSMON_MBWU_L_CAPTURE](#) also has 44-bit VALUE field in bits [43:0].

0b1 [MSMON_MBWU_L](#) has 63-bit VALUE field in bits [62:0]. If [MPAMF_MBWUMON_IDR.HAS_CAPTURE](#) == 1, [MSMON_MBWU_L_CAPTURE](#) also has 63-bit VALUE field in bits [62:0].

If RIS is implemented, this field indicates the length of the [MSMON_MBWU_L.VALUE](#) field implemented for the resource instance selected by [MPAMCFG_PART_SEL.RIS](#).

Otherwise:

Reserved, RES0.

HAS_RWBW, bit [28]

When [FEAT_MPAMv0p1](#) is implemented or [FEAT_MPAMv1p1](#) is implemented:

Read/write bandwidth selection is implemented in [MSMON_CFG_MBWU_FLT](#).

0b0 Read/write bandwidth selection is not implemented.

0b1 Read/write bandwidth selection is implemented.

If RIS is implemented, this field indicates whether read/write bandwidth collection selection is available in [MSMON_CFG_MBWU_FLT](#) for resource instance selected by [MPAMCFG_PART_SEL.RIS](#).

Otherwise:

Reserved, RES0.

HAS_OFLOW_LNKG, bit [27]

When [FEAT_MPAMv0p1](#) is implemented or [FEAT_MPAMv1p1](#) is implemented:

Supports [MSMON_CFG_MBWU_CTL.OFLOW_LNKG](#) field to control how overflow on an instance affects other monitor instances in this MSC.

0b0 Does not support MBWU overflow linkage.

0b1 Supports MBWU overflow linkage and the [MSMON_CFG_MBWU_CTL.OFLOW_LNKG](#) field.

If RIS is implemented, this field indicates that [MSMON_CFG_MBWU_CTL.OFLOW_LNKG](#) is implemented for the resource instance selected by [MPAMCFG_PART_SEL.RIS](#).

Otherwise:

Reserved, RES0.

HAS_OFSR, bit [26]

When FEAT_MPAMv0p1 is implemented or FEAT_MPAMv1p1 is implemented:

The MBWU monitor overflow status bitmap register, [MSMON_MBWU_OFSR](#), is implemented.

0b0 [MSMON_MBWU_OFSR](#) register is not implemented.

0b1 [MSMON_MBWU_OFSR](#) register is implemented.

If RIS is implemented, this field indicates that MBWU monitor overflow status bitmap register is implemented for the resource instance selected by [MPAMCFG_PART_SEL](#).RIS.

Otherwise:

Reserved, RES0.

HAS_CEVNT_OFLW, bit [25]

Supports [MSMON_CFG_MBWU_CTL.CEVNT_OFLW](#) field which can enable the MBWU monitor instance to perform overflow behaviors on a capture event.

0b0 Does not support [MSMON_CFG_MBWU_CTL.CEVNT_OFLW](#).

0b1 Supports [MSMON_CFG_MBWU_CTL.CEVNT_OFLW](#).

If RIS is implemented, this field indicates that [MSMON_CFG_MBWU_CTL.CEVNT_OFLW](#) is implemented for the resource instance selected by [MPAMCFG_PART_SEL](#).RIS.

HAS_OFLOW_CAPT, bit [24]

When FEAT_MPAMv0p1 is implemented or FEAT_MPAMv1p1 is implemented:

Supports [MSMON_CFG_CSU_CTL.OFLOW_CAPT](#) field which can enable the CSU monitor instance to capture the monitor on an overflow.

0b0 Does not support [MSMON_CFG_CSU_CTL.OFLOW_CAPT](#).

0b1 Supports [MSMON_CFG_CSU_CTL.OFLOW_CAPT](#).

If RIS is implemented, this field indicates that [MSMON_CFG_CSU_CTL.OFLOW_CAPT](#) is implemented for the resource instance selected by [MPAMCFG_PART_SEL](#).RIS.

Otherwise:

Reserved, RES0.

Bits [23:21]

Reserved, RES0.

SCALE, bits [20:16]

Scaling of [MSMON_MBWU.VALUE](#) in bits. If scaling is enabled by [MSMON_CFG_MBWU_CTL.SCLEN](#), the byte count in the VALUE field has been shifted by SCALE bits to the right.

0b00000 Scaling is not implemented.

0bxxxxx Other values are right shift count when scaling is enabled.

If RIS is implemented, this field indicates the scale value for [MSMON_MBWU.VALUE](#) field for the resource instance selected by [MPAMCFG_PART_SEL](#).RIS.

NUM_MON, bits [15:0]

The number of memory bandwidth usage monitor instances implemented. The largest monitor instance selector, [MSMON_CFG_MON_SEL.MON_SEL](#), is NUM_MON minus 1.

If RIS is implemented, this field indicates the number of MBWU monitor instances for [MSMON_MBWU.VALUE](#) field for the resource instance selected by [MPAMCFG_PART_SEL](#).RIS.

Accessing the MPAMF_MBWUMON_IDR:

This register is within the MPAM feature page memory frames. In a system that supports Secure, Non-secure, Root, and Realm memory maps, there must be MPAM feature pages in all four address maps.

MPAMF_MBWUMON_IDR is read-only.

MPAMF_MBWUMON_IDR must be readable from the Non-secure, Secure, Root, and Realm MPAM feature pages.

MPAMF_MBWUMON_IDR is permitted to have the same contents when read from the Secure, Non-secure, Root, and Realm MPAM feature pages unless the register contents are different for the different versions:

- MPAMF_MBWUMON_IDR_s is permitted to have either the same or different contents to MPAMF_MBWUMON_IDR_ns, MPAMF_MBWUMON_IDR_rt, or MPAMF_MBWUMON_IDR_rl.
- MPAMF_MBWUMON_IDR_ns is permitted to have either the same or different contents to MPAMF_MBWUMON_IDR_rt or MPAMF_MBWUMON_IDR_rl.
- MPAMF_MBWUMON_IDR_rt is permitted to have either the same or different contents to MPAMF_MBWUMON_IDR_rl.

There must be separate registers in the Secure (MPAMF_MBWUMON_IDR_s), Non-secure (MPAMF_MBWUMON_IDR_ns), Root (MPAMF_MBWUMON_IDR_rt), and Realm (MPAMF_MBWUMON_IDR_rl) MPAM feature pages.

When MPAMF_IDR.HAS_RIS is 1, MPAMF_MBWUMON_IDR shows the configuration of memory bandwidth monitoring for the bandwidth resource instance selected by MPAMCFG_PART_SEL.RIS. Fields that mention RIS in their field descriptions have values that track the implemented properties of the resource instance. Fields that do not mention RIS are constant across all resource instances.

Access to MPAMF_MBWUMON_IDR is not affected by MSMON_CFG_MON_SEL.RIS.

MPAMF_MBWUMON_IDR can be accessed through its memory-mapped interface:

Component	Frame	Offset	Instance
MPAM	MPAMF_BASE_s	0x0090	MPAMF_MBWUMON_IDR_s

Accesses to this interface are RO.

MPAMF_MBWUMON_IDR can be accessed through its memory-mapped interface:

Component	Frame	Offset	Instance
MPAM	MPAMF_BASE_ns	0x0090	MPAMF_MBWUMON_IDR_ns

Accesses to this interface are RO.

MPAMF_MBWUMON_IDR can be accessed through its memory-mapped interface:

Component	Frame	Offset	Instance
MPAM	MPAMF_BASE_rt	0x0090	MPAMF_MBWUMON_IDR_rt

When FEAT_RME is implemented, accesses to this interface are RO.

MPAMF_MBWUMON_IDR can be accessed through its memory-mapped interface:

Component	Frame	Offset	Instance
MPAM	MPAMF_BASE_rl	0x0090	MPAMF_MBWUMON_IDR_rl

When FEAT_RME is implemented, accesses to this interface are RO.

11.3.10 MPAMF_MSMON_IDR, MPAM Resource Monitoring Identification Register

The MPAMF_MSMON_IDR characteristics are:

Purpose

Indicates which MPAM monitoring features are present on this MSC.

MPAMF_MSMON_IDR_s indicates Secure monitoring features. MPAMF_MSMON_IDR_ns indicates Non-secure monitoring features. MPAMF_MSMON_IDR_rt indicates Root monitoring features. MPAMF_MSMON_IDR_rl indicates Realm monitoring features.

If [MPAMF_IDR.HAS_RIS](#) is 1, fields that mention RIS must reflect the properties of the resource instance currently selected by [MPAMCFG_PART_SEL.RIS](#). Fields that do not mention RIS are constant across all resource instances.

Configurations

The power domain of MPAMF_MSMON_IDR is IMPLEMENTATION DEFINED.

This register is present only when FEAT_MPAM is implemented and MPAMF_IDR.HAS_MSMON == 1. Otherwise, direct accesses to MPAMF_MSMON_IDR are RES0.

The power and reset domain of each MSC component is specific to that component.

Attributes

MPAMF_MSMON_IDR is a 32-bit register.

Field descriptions

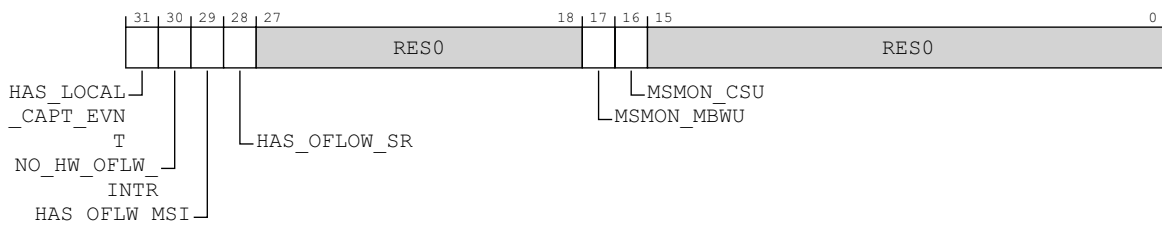

HAS_LOCAL_CAPT_EVNT, bit [31]

Has local capture event generator. Indicates whether this MSC has the MPAM local capture event generator and the [MSMON_CAPT_EVNT](#) register.

- 0b0 Does not support MPAM local capture event generator or [MSMON_CAPT_EVNT](#).
- 0b1 Supports the MPAM local capture event generator and the [MSMON_CAPT_EVNT](#) register.

NO_HW_OFLW_INTR, bit [30]

When FEAT_MPAMv1p1 is implemented:

Does not have hardwired MPAM monitor overflow interrupt.

- 0b0 Supports generating a hardwired interrupt to signal MPAM monitor overflow.
- 0b1 No support for a hardwired interrupt to signal MPAM monitor overflow.

If this field is 0, the MSC supports generating a hardwired interrupt for monitor overflow events.

If this field is 0 and the HAS_OFLW_MSI field in this register is 1, the MSC supports generating both hardwired interrupts and MSI writes to signal interrupts.

Otherwise:

Reserved, RES0.

HAS_OFLW_MSI, bit [29]

When FEAT_MPAMv1p1 is implemented:

Has support for MSI writes to signal MPAM monitor overflow interrupts. These registers are implemented: [MSMON_OFLOW_MSI_ADDR_L](#), [MSMON_OFLOW_MSI_ADDR_H](#), [MSMON_OFLOW_MSI_ATTR](#), [MSMON_OFLOW_MSI_DATA](#) and [MSMON_OFLOW_MSI_MPAM](#).

0b0 [MSMON_OFLOW_MSI_ADDR_L](#), [MSMON_OFLOW_MSI_ADDR_H](#), [MSMON_OFLOW_MSI_ATTR](#), [MSMON_OFLOW_MSI_DATA](#) and [MSMON_OFLOW_MSI_MPAM](#) registers are not implemented.

0b1 [MSMON_OFLOW_MSI_ADDR_L](#), [MSMON_OFLOW_MSI_ADDR_H](#), [MSMON_OFLOW_MSI_ATTR](#), [MSMON_OFLOW_MSI_DATA](#) and [MSMON_OFLOW_MSI_ATTR](#) are implemented and can be used to generate writes to signal MPAM monitor overflow interrupts.

If [MPAMF_MSMON_IDR.NO_HW_OFLW_INTR](#) is 1 and this bit is 0, this MSC does not support monitor overflow interrupts.

Otherwise:

Reserved, RES0.

HAS_OFLOW_SR, bit [28]

When FEAT_MPAMv1p1 is implemented:

Has MPAM monitor overflow status register [MSMON_OFLOW_SR](#).

0b0 Does not have [MSMON_OFLOW_SR](#).

0b1 Supports [MSMON_OFLOW_SR](#).

Otherwise:

Reserved, RES0.

Bits [27:18]

Reserved, RES0.

MSMON_MBWU, bit [17]

Memory bandwidth usage monitoring. Indicates whether MPAM monitoring for Memory Bandwidth Usage by PARTID and PMG is implemented and whether the following bandwidth usage registers are accessible:

- [MPAMF_MBWUMON_IDR](#), [MSMON_CFG_MBWU_CTL](#), [MSMON_CFG_MBWU_FLT](#), [MSMON_MBWU](#).
- The optional [MSMON_MBWU_CAPTURE](#).
- If MPAM v0.1 or MPAM v1.1 is implemented, the optional [MSMON_MBWU_L](#) and the optional [MSMON_MBWU_L_CAPTURE](#).

0b0 Does not have monitoring for memory bandwidth usage and does not use the bandwidth usage registers.

0b1 Has monitoring of memory bandwidth usage and uses the bandwidth usage registers.

If RIS is implemented, this field indicates that memory bandwidth usage monitoring is implemented for the resource instance selected by [MPAMCFG_PART_SEL.RIS](#) as described in [MPAMF_MBWUMON_IDR](#).

MSMON_CSU, bit [16]

Cache storage usage monitoring. Indicates whether MPAM monitoring of cache storage usage by PARTID and PMG is implemented and the following registers are accessible:

- [MPAMF_CSUMON_IDR](#), [MSMON_CFG_CSU_CTL](#), [MSMON_CFG_CSU_FLT](#), [MSMON_CSU](#).

- The optional [MSMON_CSU_CAPTURE](#).
- 0b0 Does not have monitoring for cache storage usage or the [MPAMF_CSUMON_IDR](#), [MSMON_CFG_CSU_CTL](#), [MSMON_CFG_CSU_FLT](#), [MSMON_CSU](#) or [MSMON_CSU_CAPTURE](#) registers.
- 0b1 Has monitoring of cache storage usage and the [MPAMF_CSUMON_IDR](#), [MSMON_CFG_CSU_CTL](#), [MSMON_CFG_CSU_FLT](#), [MSMON_CSU](#) and optional [MSMON_CSU_CAPTURE](#) registers.

If RIS is implemented, this field indicates that cache storage usage monitoring is implemented for the resource instance selected by [MPAMCFG_PART_SEL.RIS](#) as described in [MPAMF_CSUMON_IDR](#).

Bits [15:0]

Reserved, RES0.

Accessing the MPAMF_MSMON_IDR:

This register is within the MPAM feature page memory frames. In a system that supports Secure, Non-secure, Root, and Realm memory maps, there must be MPAM feature pages in all four address maps.

MPAMF_MSMON_IDR is read-only.

MPAMF_MSMON_IDR must be readable from the Non-secure, Secure, Root, and Realm MPAM feature pages.

MPAMF_MSMON_IDR is permitted to have the same contents when read from the Secure, Non-secure, Root, and Realm MPAM feature pages unless the register contents are different for the different versions:

- MPAMF_MSMON_IDR_s is permitted to have either the same or different contents to MPAMF_MSMON_IDR_ns, MPAMF_MSMON_IDR_rt, or MPAMF_MSMON_IDR_rl.
- MPAMF_MSMON_IDR_ns is permitted to have either the same or different contents to MPAMF_MSMON_IDR_rt or MPAMF_MSMON_IDR_rl.
- MPAMF_MSMON_IDR_rt is permitted to have either the same or different contents to MPAMF_MSMON_IDR_rl.

There must be separate registers in the Secure (MPAMF_MSMON_IDR_s), Non-secure (MPAMF_MSMON_IDR_ns), Root (MPAMF_MSMON_IDR_rt), and Realm (MPAMF_MSMON_IDR_rl) MPAM feature pages.

When [MPAMF_IDR.HAS_RIS](#) is 1, MPAMF_MSMON_IDR shows the configuration of memory system monitoring for the resource instance selected by [MPAMCFG_PART_SEL.RIS](#). Fields that mention RIS in their field descriptions have values that track the implemented properties of the resource instance. Fields that do not mention RIS are constant across all resource instances.

Access to MPAMF_MSMON_IDR is not affected by [MSMON_CFG_MON_SEL.RIS](#).

MPAMF_MSMON_IDR can be accessed through its memory-mapped interface:

Component	Frame	Offset	Instance
MPAM	MPAMF_BASE_s	0x0080	MPAMF_MSMON_IDR_s

Accesses to this interface are RO.

MPAMF_MSMON_IDR can be accessed through its memory-mapped interface:

Component	Frame	Offset	Instance
MPAM	MPAMF_BASE_ns	0x0080	MPAMF_MSMON_IDR_ns

Accesses to this interface are RO.

MPAMF_MSMON_IDR can be accessed through its memory-mapped interface:

Component	Frame	Offset	Instance
MPAM	MPAMF_BASE_rt	0x0080	MPAMF_MSMON_IDR_rt

When FEAT_RME is implemented, accesses to this interface are RO.

MPAMF_MSMON_IDR can be accessed through its memory-mapped interface:

Component	Frame	Offset	Instance
MPAM	MPAMF_BASE_rl	0x0080	MPAMF_MSMON_IDR_rl

When FEAT_RME is implemented, accesses to this interface are RO.

11.3.11 MPAMF_PARTID_NRW_IDR, MPAM PARTID Narrowing ID register

The MPAMF_PARTID_NRW_IDR characteristics are:

Purpose

Indicates the largest internal PARTID for this MSC.

MPAMF_PARTID_NRW_IDR_s indicates the largest Secure internal PARTID.

MPAMF_PARTID_NRW_IDR_ns indicates the largest Non-secure internal PARTID.

When FEAT_RME is implemented: MPAMF_PARTID_NRW_rt indicates the largest Root internal PARTID. MPAMF_PARTID_NRW_rl indicates the largest Realm internal PARTID.

PARTID narrowing is global to the MSC and does not vary by resource instance.

Configurations

The power domain of MPAMF_PARTID_NRW_IDR is IMPLEMENTATION DEFINED.

This register is present only when FEAT_MPAM is implemented and MPAMF_IDR.HAS_PARTID_NRW == 1. Otherwise, direct accesses to MPAMF_PARTID_NRW_IDR are RES0.

The power and reset domain of each MSC component is specific to that component.

Attributes

MPAMF_PARTID_NRW_IDR is a 32-bit register.

Field descriptions

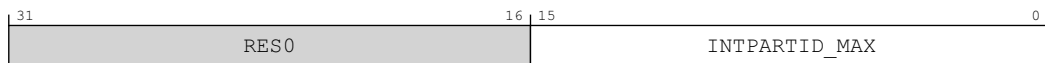

Bits [31:16]

Reserved, RES0.

INTPARTID_MAX, bits [15:0]

The largest intPARTID supported in this MSC.

Accessing the MPAMF_PARTID_NRW_IDR:

This register is within the MPAM feature page memory frames. In a system that supports Secure, Non-secure, Root, and Realm memory maps, there must be MPAM feature pages in all four address maps.

MPAMF_PARTID_NRW_IDR is read-only.

MPAMF_PARTID_NRW_IDR must be readable from the Non-secure, Secure, Root, and Realm MPAM feature pages.

MPAMF_PARTID_NRW_IDR is permitted to have the same contents when read from the Secure, Non-secure, Root, and Realm MPAM feature pages unless the register contents are different for the different versions:

- MPAMF_PARTID_NRW_IDR_s is permitted to have either the same or different contents to MPAMF_PARTID_NRW_IDR_ns, MPAMF_PARTID_NRW_IDR_rt, or MPAMF_PARTID_NRW_IDR_rl.
- MPAMF_PARTID_NRW_IDR_ns is permitted to have either the same or different contents to MPAMF_PARTID_NRW_IDR_rt or MPAMF_PARTID_NRW_IDR_rl.
- MPAMF_PARTID_NRW_IDR_rt is permitted to have either the same or different contents to MPAMF_PARTID_NRW_IDR_rl.

There must be separate registers in the Secure (MPAMF_PARTID_NRW_IDR_s), Non-secure (MPAMF_PARTID_NRW_IDR_ns), Root (MPAMF_PARTID_NRW_IDR_rt), and Realm (MPAMF_PARTID_NRW_IDR_rl) MPAM feature pages.

MPAMF_PARTID_NRW_IDR can be accessed through its memory-mapped interface:

Component	Frame	Offset	Instance
MPAM	MPAMF_BASE_s	0x0050	MPAMF_PARTID_NRW_IDR_s

Accesses to this interface are RO.

MPAMF_PARTID_NRW_IDR can be accessed through its memory-mapped interface:

Component	Frame	Offset	Instance
MPAM	MPAMF_BASE_ns	0x0050	MPAMF_PARTID_NRW_IDR_ns

Accesses to this interface are RO.

MPAMF_PARTID_NRW_IDR can be accessed through its memory-mapped interface:

Component	Frame	Offset	Instance
MPAM	MPAMF_BASE_rt	0x0050	MPAMF_PARTID_NRW_IDR_rt

When FEAT_RME is implemented, accesses to this interface are RO.

MPAMF_PARTID_NRW_IDR can be accessed through its memory-mapped interface:

Component	Frame	Offset	Instance
MPAM	MPAMF_BASE_rl	0x0050	MPAMF_PARTID_NRW_IDR_rl

When FEAT_RME is implemented, accesses to this interface are RO.

11.3.12 MPAMF_PRI_IDR, MPAM Priority Partitioning Identification Register

The MPAMF_PRI_IDR characteristics are:

Purpose

Indicates which MPAM priority partitioning features are present on this MSC.

MPAMF_PRI_IDR_s indicates priority partitioning features accessed from the Secure MPAM feature page. MPAMF_PRI_IDR_ns indicates priority partitioning features accessed from the Non-secure MPAM feature page. MPAMF_PRI_IDR_rt indicates priority partitioning features accessed from the Root MPAM feature page. MPAMF_PRI_IDR_rl indicates priority partitioning features accessed from the Realm MPAM feature page.

When MPAMF_IDR.HAS_RIS is 1, some fields in this register give information for the resource instance selected by MPAMCFG_PART_SEL.RIS. The description of every field that is affected by MPAMCFG_PART_SEL.RIS has that information within the field description.

Configurations

The power domain of MPAMF_PRI_IDR is IMPLEMENTATION DEFINED.

This register is present only when FEAT_MPAM is implemented and MPAMF_IDR.HAS_PRI_PART == 1. Otherwise, direct accesses to MPAMF_PRI_IDR are RES0.

The power and reset domain of each MSC component is specific to that component.

Attributes

MPAMF_PRI_IDR is a 32-bit register.

Field descriptions

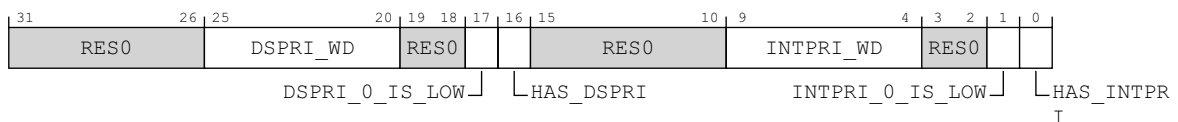

Bits [31:26]

Reserved, RES0.

DSPRI_WD, bits [25:20]

Number of implemented bits in the downstream priority field (DSPRI) of MPAMCFG_PRI.

If HAS_DSPRI == 1, this field must contain a value from 1 to 16, inclusive.

If HAS_DSPRI == 0, this field must be 0.

If RIS is implemented, this field indicates the number of downstream priority bits for the resource instance selected by MPAMCFG_PART_SEL.RIS.

Bits [19:18]

Reserved, RES0.

DSPRI_0_IS_LOW, bit [17]

Indicates whether 0 in MPAMCFG_PRI.DSPRI is the lowest or the highest downstream priority.

0b0 In the MPAMCFG_PRI.DSPRI field, a value of 0 means the highest priority.

0b1 In the MPAMCFG_PRI.DSPRI field, a value of 0 means the lowest priority.

If RIS is implemented, this field indicates that 0 is the lowest downstream priority for the resource instance selected by MPAMCFG_PART_SEL.RIS.

HAS_DSPRI, bit [16]

Indicates that the [MPAMCFG_PRI](#) register implements the DSPRI field.

0b0 This MSC supports priority partitioning, but does not implement a downstream priority (DSPRI) field in the [MPAMCFG_PRI](#) register.

0b1 This MSC supports downstream priority partitioning and implements the downstream priority (DSPRI) field in the [MPAMCFG_PRI](#) register.

If RIS is implemented, this field indicates that downstream priority is implemented for the resource instance selected by [MPAMCFG_PART_SEL.RIS](#).

Bits [15:10]

Reserved, RES0.

INTPRI_WD, bits [9:4]

Number of implemented bits in the internal priority field (INTPRI) in the [MPAMCFG_PRI](#) register.

If HAS_INTPRI == 1, this field must contain a value from 1 to 16, inclusive.

If HAS_INTPRI == 0, this field must be 0.

If RIS is implemented, this field indicates the number of internal priority bits for the resource instance selected by [MPAMCFG_PART_SEL.RIS](#).

Bits [3:2]

Reserved, RES0.

INTPRI_0_IS_LOW, bit [1]

Indicates whether 0 in [MPAMCFG_PRI.INTPRI](#) is the lowest or the highest internal priority.

0b0 In the [MPAMCFG_PRI.INTPRI](#) field, a value of 0 means the highest priority.

0b1 In the [MPAMCFG_PRI.INTPRI](#) field, a value of 0 means the lowest priority.

If RIS is implemented, this field indicates that 0 is the lowest internal priority for the resource instance selected by [MPAMCFG_PART_SEL.RIS](#).

HAS_INTPRI, bit [0]

Indicates that this MSC implements the INTPRI field in the [MPAMCFG_PRI](#) register.

0b0 This MSC supports priority partitioning, but does not implement the internal priority (INTPRI) field in the [MPAMCFG_PRI](#) register.

0b1 This MSC supports internal priority partitioning and implements the internal priority (INTPRI) field in the [MPAMCFG_PRI](#) register.

If RIS is implemented, this field indicates that internal priority is implemented for the resource instance selected by [MPAMCFG_PART_SEL.RIS](#).

Accessing the MPAMF_PRI_IDR:

This register is within the MPAM feature page memory frames. In a system that supports Secure, Non-secure, Root, and Realm memory maps, there must be MPAM feature pages in all four address maps.

MPAMF_PRI_IDR is read-only.

MPAMF_PRI_IDR must be readable from the Non-secure, Secure, Root, and Realm MPAM feature pages.

MPAMF_PRI_IDR is permitted to have the same contents when read from the Secure, Non-secure, Root, and Realm MPAM feature pages unless the register contents are different for the different versions:

- MPAMF_PRI_IDR_s is permitted to have either the same or different contents to MPAMF_PRI_IDR_ns, MPAMF_PRI_IDR_rt, or MPAMF_PRI_IDR_rl.
- MPAMF_PRI_IDR_ns is permitted to have either the same or different contents to MPAMF_PRI_IDR_rt or MPAMF_PRI_IDR_rl.

- MPAMF_PRI_IDR_rt is permitted to have either the same or different contents to MPAMF_PRI_IDR_rl.

There must be separate registers in the Secure (MPAMF_PRI_IDR_s), Non-secure (MPAMF_PRI_IDR_ns), Root (MPAMF_PRI_IDR_rt), and Realm (MPAMF_PRI_IDR_rl) MPAM feature pages.

When MPAMF_IDR.HAS_RIS is 1, MPAMF_PRI_IDR shows the configuration of priority partitioning for the resource instance selected by MPAMCFG_PART_SEL.RIS. Fields that mention RIS in their field descriptions have values that track the implemented properties of the resource instance. Fields that do not mention RIS are constant across all resource instances.

MPAMF_PRI_IDR can be accessed through its memory-mapped interface:

Component	Frame	Offset	Instance
MPAM	MPAMF_BASE_s	0x0048	MPAMF_PRI_IDR_s

Accesses to this interface are RO.

MPAMF_PRI_IDR can be accessed through its memory-mapped interface:

Component	Frame	Offset	Instance
MPAM	MPAMF_BASE_ns	0x0048	MPAMF_PRI_IDR_ns

Accesses to this interface are RO.

MPAMF_PRI_IDR can be accessed through its memory-mapped interface:

Component	Frame	Offset	Instance
MPAM	MPAMF_BASE_rt	0x0048	MPAMF_PRI_IDR_rt

When FEAT_RME is implemented, accesses to this interface are RO.

MPAMF_PRI_IDR can be accessed through its memory-mapped interface:

Component	Frame	Offset	Instance
MPAM	MPAMF_BASE_rl	0x0048	MPAMF_PRI_IDR_rl

When FEAT_RME is implemented, accesses to this interface are RO.

11.3.13 MPAMF_SIDR, MPAM Features Secure Identification Register

The MPAMF_SIDR characteristics are:

Purpose

The MPAMF_SIDR is a 32-bit read-only register that indicates the maximum Secure PARTID and Secure PMG on this MSC.

Configurations

The power domain of MPAMF_SIDR is IMPLEMENTATION DEFINED.

This register is present only when FEAT_MPAM is implemented. Otherwise, direct accesses to MPAMF_SIDR are RES0.

The power and reset domain of each MSC component is specific to that component.

Attributes

MPAMF_SIDR is a 32-bit register.

Field descriptions

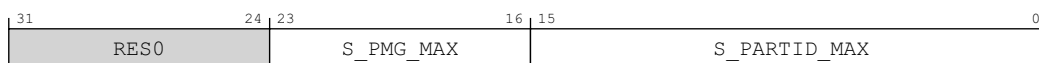

Bits [31:24]

Reserved, RES0.

S_PMG_MAX, bits [23:16]

Maximum value of Secure PMG supported by this component.

S_PARTID_MAX, bits [15:0]

Maximum value of Secure PARTID supported by this component.

Accessing the MPAMF_SIDR:

This register is only within the Secure MPAM feature page memory frame.

MPAMF_SIDR is read-only.

MPAMF_SIDR must only be readable from the Secure MPAM feature page. If the system or the MSC does not support the Secure address map, this register must not be accessible.

MPAMF_SIDR can be accessed through its memory-mapped interface:

Component	Frame	Offset	Instance
MPAM	MPAMF_BASE_s	0x0008	MPAMF_SIDR_s

Accesses to this interface are RO.

11.4 Memory-mapped partitioning configuration registers

This section lists the external partitioning configuration registers.

11.4.1 MPAMCFG_CASSOC, MPAM Cache Maximum Associativity Partition Configuration Register

The MPAMCFG_CASSOC characteristics are:

Purpose

The MPAMCFG_CASSOC is a 32-bit read/write register that controls the maximum fraction of the cache associativity that the PARTID selected by [MPAMCFG_PART_SEL](#) is permitted to allocate.

MPAMCFG_CASSOC_s controls the cache maximum associativity for the Secure PARTID selected by the Secure instance of [MPAMCFG_PART_SEL](#). MPAMCFG_CASSOC_ns controls the cache maximum associativity for the Non-secure PARTID selected by the Non-secure instance of [MPAMCFG_PART_SEL](#). MPAMCFG_CASSOC_rl controls the cache maximum associativity for the Realm PARTID selected by the Realm instance of [MPAMCFG_PART_SEL](#). MPAMCFG_CASSOC_rt controls the cache maximum associativity for the Root PARTID selected by the Root instance of [MPAMCFG_PART_SEL](#).

If [MPAMF_IDR.HAS_RIS](#) is 1, the control settings accessed are those of the resource instance currently selected by [MPAMCFG_PART_SEL.RIS](#) and the PARTID selected by [MPAMCFG_PART_SEL.PARTID_SEL](#).

Configurations

The power domain of MPAMCFG_CASSOC is IMPLEMENTATION DEFINED.

This register is present only when [MPAMF_IDR.HAS_CCAP_PART](#) == 1, ([FEAT_MPAMv0p1](#) is implemented or [FEAT_MPAMv1p1](#) is implemented) and [MPAMF_CCAP_IDR.HAS_CASSOC](#) == 1. Otherwise, direct accesses to MPAMCFG_CASSOC are RES0.

Attributes

MPAMCFG_CASSOC is a 32-bit register.

Field descriptions



Bits [31:16]

Reserved, RES0.

CASSOC, bits [15:0]

Maximum cache associativity usage in fixed-point fraction format by the partition selected by [MPAMCFG_PART_SEL](#). The fraction represents the portion of the cache associativity that the PARTID is permitted to allocate. CASSOC controls the fraction of associativity in each associativity grouping of the cache. In a set associative cache, CASSOC applies to the fraction of the ways in each set.

The implemented width of the fixed-point fraction is given in [MPAMF_CCAP_IDR.CASSOC_WD](#). Unimplemented bits within the field are RAZ/WI. The implemented bits of the CASSOC field are always the most significant bits of the field.

The fixed-point fraction CASSOC is less than 1. The implied binary point is between bits 15 and 16. This representation has as the largest fraction of the cache that can be represented in an implementation with w implemented bits is 1.0 minus one half to the power w.

Accessing the MPAMCFG_CASSOC:

This register is within the MPAM feature page memory frames.

In a system that supports Secure, Non-secure, Root, and Realm memory maps, there must be MPAM feature pages in all four address maps:

- MPAMCFG_CASSOC_s must be accessible from the Secure MPAM feature page.
- MPAMCFG_CASSOC_ns must be accessible from the Non-secure MPAM feature page.
- MPAMCFG_CASSOC_rt must be accessible from the Root MPAM feature page.
- MPAMCFG_CASSOC_rl must be accessible from the Realm MPAM feature page.

MPAMCFG_CASSOC_s, MPAMCFG_CASSOC_ns, MPAMCFG_CASSOC_rt, and MPAMCFG_CASSOC_rl must be separate registers:

- The Secure instance (MPAMCFG_CASSOC_s) accesses the cache maximum associativity partitioning used for Secure PARTIDs.
- The Non-secure instance (MPAMCFG_CASSOC_ns) accesses the cache maximum associativity partitioning used for Non-secure PARTIDs.
- The Root instance (MPAMCFG_CASSOC_rt) accesses the cache maximum associativity partitioning used for Root PARTIDs.
- The Realm instance (MPAMCFG_CASSOC_rl) accesses the cache maximum associativity partitioning used for Realm PARTIDs.

When RIS is implemented, loads and stores to MPAMCFG_CASSOC access the cache maximum associativity partitioning configuration settings for the cache resource instance selected by MPAMCFG_PART_SEL.RIS and the PARTID selected by MPAMCFG_PART_SEL.PARTID_SEL.

When RIS is not implemented, loads and stores to MPAMCFG_CASSOC access the cache maximum associativity partitioning configuration settings for the PARTID selected by MPAMCFG_PART_SEL.PARTID_SEL.

When PARTID narrowing is implemented, loads and stores to MPAMCFG_CASSOC access the cache maximum associativity partitioning configuration settings for the internal PARTID selected by MPAMCFG_PART_SEL.PARTID_SEL, and MPAMCFG_PART_SEL.INTERNAL must be 1.

When PARTID narrowing is not implemented, loads and stores to MPAMCFG_CASSOC access the cache maximum associativity partitioning configuration settings for the request PARTID selected by MPAMCFG_PART_SEL.PARTID_SEL, and MPAMCFG_PART_SEL.INTERNAL must be 0.

MPAMCFG_CASSOC can be accessed through its memory-mapped interface:

Component	Frame	Offset	Instance
MPAM	MPAMF_BASE_s	0x0118	MPAMCFG_CASSOC_s

Accesses to this interface are RW.

MPAMCFG_CASSOC can be accessed through its memory-mapped interface:

Component	Frame	Offset	Instance
MPAM	MPAMF_BASE_ns	0x0118	MPAMCFG_CASSOC_ns

Accesses to this interface are RW.

MPAMCFG_CASSOC can be accessed through its memory-mapped interface:

Component	Frame	Offset	Instance
MPAM	MPAMF_BASE_rt	0x0118	MPAMCFG_CASSOC_rt

When FEAT_RME is implemented, accesses to this interface are RW.

MPAMCFG_CASSOC can be accessed through its memory-mapped interface:

Component	Frame	Offset	Instance
MPAM	MPAMF_BASE_r1	0x0118	MPAMCFG_CASSOC_r1

When FEAT_RME is implemented, accesses to this interface are RW.

11.4.2 MPAMCFG_CMAX, MPAM Cache Maximum Capacity Partition Configuration Register

The MPAMCFG_CMAX characteristics are:

Purpose

The MPAMCFG_CMAX is a 32-bit read/write register that controls the maximum fraction of the cache capacity that the PARTID selected by MPAMCFG_PART_SEL is permitted to allocate.

MPAMCFG_CMAX_s controls the cache maximum capacity for the Secure PARTID selected by the Secure instance of MPAMCFG_PART_SEL. MPAMCFG_CMAX_ns controls the cache maximum capacity for the Non-secure PARTID selected by the Non-secure instance of MPAMCFG_PART_SEL. MPAMCFG_CMAX_rt controls the cache maximum capacity for the Root PARTID selected by the Root instance of MPAMCFG_PART_SEL. MPAMCFG_CMAX_rl controls the cache maximum capacity for the Realm PARTID selected by the Realm instance of MPAMCFG_PART_SEL.

If MPAMF_IDR.HAS_RIS is 1, the control settings accessed are those of the resource instance currently selected by MPAMCFG_PART_SEL.RIS and the PARTID selected by MPAMCFG_PART_SEL.PARTID_SEL.

Configurations

The power domain of MPAMCFG_CMAX is IMPLEMENTATION DEFINED.

This register is present only when FEAT_MPAM is implemented, MPAMF_IDR.HAS_CCAP_PART == 1 and MPAMF_CCAP_IDR.NO_CMAX == 0. Otherwise, direct accesses to MPAMCFG_CMAX are RES0.

The power and reset domain of each MSC component is specific to that component.

Attributes

MPAMCFG_CMAX is a 32-bit register.

Field descriptions

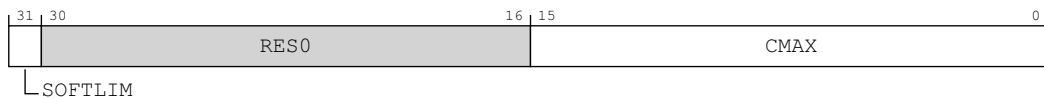

SOFTLIM, bit [31]

When (FEAT_MPAMv0p1 is implemented or FEAT_MPAMv1p1 is implemented) and MPAMF_CCAP_IDR.HAS_CMAX_SOFTLIM == 1:

Soft limiting of CMAX. Soft limiting allows some allocations by a PARTID when its cache use is above the CMAX maximum cache capacity.

0b0 When CMAX cache capacity is exceeded, the partition is not allowed to increase its cache capacity usage. It is only permitted to replace a line that was previously occupied by a line allocated by that PARTID.

0b1 When CMAX cache capacity is exceeded, the partition is permitted to allocate capacity beyond CMAX, but only from invalid lines or lines belonging to disabled PARTIDs.

Otherwise:

Reserved, RES0.

Bits [30:16]

Reserved, RES0.

CMAX, bits [15:0]

Maximum cache capacity usage in fixed-point fraction format by the partition selected by [MPAMCFG_PART_SEL](#). The fraction represents the portion of the total cache capacity that the PARTID is permitted to allocate.

The implemented width of the fixed-point fraction is given in [MPAMF_CCAP_IDR.CMAX_WD](#). Unimplemented bits within the field are RAZ/WI. The implemented bits of the CMAX field are always the most significant bits of the field.

The fixed-point fraction CMAX is less than 1. The implied binary point is between bits 15 and 16. This representation has as the largest fraction of the cache that can be represented in an implementation with w implemented bits is 1.0 minus one half to the power w.

Accessing the MPAMCFG_CMAX:

This register is within the MPAM feature page memory frames.

In a system that supports Secure, Non-secure, Root, and Realm memory maps, there must be MPAM feature pages in all four address maps:

- MPAMCFG_CMAX_s must be accessible from the Secure MPAM feature page.
- MPAMCFG_CMAX_ns must be accessible from the Non-secure MPAM feature page.
- MPAMCFG_CMAX_rt must be accessible from the Root MPAM feature page.
- MPAMCFG_CMAX_rl must be accessible from the Realm MPAM feature page.

MPAMCFG_CMAX_s, MPAMCFG_CMAX_ns, MPAMCFG_CMAX_rt, and MPAMCFG_CMAX_rl must be separate registers:

- The Secure instance (MPAMCFG_CMAX_s) accesses the cache capacity partitioning used for Secure PARTIDs.
- The Non-secure instance (MPAMCFG_CMAX_ns) accesses the cache capacity partitioning used for Non-secure PARTIDs.
- The Root instance (MPAMCFG_CMAX_rt) accesses the cache capacity partitioning used for Root PARTIDs.
- The Realm instance (MPAMCFG_CMAX_rl) accesses the cache capacity partitioning used for Realm PARTIDs.

When RIS is implemented, loads and stores to MPAMCFG_CMAX access the cache maximum capacity partitioning configuration settings for the cache resource instance selected by [MPAMCFG_PART_SEL.RIS](#) and the PARTID selected by [MPAMCFG_PART_SEL.PARTID_SEL](#).

When RIS is not implemented, loads and stores to MPAMCFG_CMAX access the cache maximum capacity partitioning configuration settings for the PARTID selected by [MPAMCFG_PART_SEL.PARTID_SEL](#).

When PARTID narrowing is implemented, loads and stores to MPAMCFG_CMAX access the cache maximum capacity partitioning configuration settings for the internal PARTID selected by [MPAMCFG_PART_SEL.PARTID_SEL](#), and [MPAMCFG_PART_SEL.INTERNAL](#) must be 1.

When PARTID narrowing is not implemented, loads and stores to MPAMCFG_CMAX access the cache maximum capacity partitioning configuration settings for the request PARTID selected by [MPAMCFG_PART_SEL.PARTID_SEL](#), and [MPAMCFG_PART_SEL.INTERNAL](#) must be 0.

MPAMCFG_CMAX can be accessed through its memory-mapped interface:

Component	Frame	Offset	Instance
MPAM	MPAMF_BASE_s	0x0108	MPAMCFG_CMAX_s

Accesses to this interface are RW.

MPAMCFG_CMAX can be accessed through its memory-mapped interface:

Component	Frame	Offset	Instance
MPAM	MPAMF_BASE_ns	0x0108	MPAMCFG_CMAX_ns

Accesses to this interface are RW.

MPAMCFG_CMAX can be accessed through its memory-mapped interface:

Component	Frame	Offset	Instance
MPAM	MPAMF_BASE_rt	0x0108	MPAMCFG_CMAX_rt

When FEAT_RME is implemented, accesses to this interface are RW.

MPAMCFG_CMAX can be accessed through its memory-mapped interface:

Component	Frame	Offset	Instance
MPAM	MPAMF_BASE_rl	0x0108	MPAMCFG_CMAX_rl

When FEAT_RME is implemented, accesses to this interface are RW.

11.4.3 MPAMCFG_CMIN, MPAM Cache Minimum Capacity Partition Configuration Register

The MPAMCFG_CMIN characteristics are:

Purpose

The MPAMCFG_CMIN is a 32-bit read/write register that controls the fraction of the cache capacity that the PARTID selected by [MPAMCFG_PART_SEL](#) has priority to allocate.

MPAMCFG_CMIN_s controls the cache minimum capacity for the Secure PARTID selected by the Secure instance of [MPAMCFG_PART_SEL](#). MPAMCFG_CMIN_ns controls the cache minimum capacity for the Non-secure PARTID selected by the Non-secure instance of [MPAMCFG_PART_SEL](#). MPAMCFG_CMIN_rl controls the cache minimum capacity for the Realm PARTID selected by the Realm instance of [MPAMCFG_PART_SEL](#). MPAMCFG_CMIN_rt controls the cache minimum capacity for the Root PARTID selected by the Root instance of [MPAMCFG_PART_SEL](#).

If [MPAMF_IDR.HAS_RIS](#) is 1, the control settings accessed are those of the resource instance currently selected by [MPAMCFG_PART_SEL.RIS](#) and the PARTID selected by [MPAMCFG_PART_SEL.PARTID_SEL](#).

Configurations

The power domain of MPAMCFG_CMIN is IMPLEMENTATION DEFINED.

This register is present only when [MPAMF_IDR.HAS_CCAP_PART](#) == 1, ([FEAT_MPAMv0p1](#) is implemented or [FEAT_MPAMv1p1](#) is implemented) and [MPAMF_CCAP_IDR.HAS_CMIN](#) == 1. Otherwise, direct accesses to MPAMCFG_CMIN are RES0.

Attributes

MPAMCFG_CMIN is a 32-bit register.

Field descriptions



Bits [31:16]

Reserved, RES0.

CMIN, bits [15:0]

Minimum cache capacity usage in fixed-point fraction format by the partition selected by [MPAMCFG_PART_SEL](#). The fraction represents the portion of the total cache capacity that the PARTID has priority to allocate.

The implemented width of the fixed-point fraction is the same as the width of [MPAMCFG_CMAX.CMAX](#) which is given in [MPAMF_CCAP_IDR.CMAX_WD](#). Unimplemented bits within the field are RAZ/WI. The implemented bits of the CMIN field are always the most significant bits of the field.

The fixed-point fraction CMIN is less than 1. The implied binary point is between bits 15 and 16. This representation has as the largest fraction of the cache that can be represented in an implementation with w implemented bits is 1.0 minus one half to the power w.

Accessing the MPAMCFG_CMIN:

This register is within the MPAM feature page memory frames.

In a system that supports Secure, Non-secure, Root, and Realm memory maps, there must be MPAM feature pages in all four address maps:

- MPAMCFG_CMIN_s must be accessible from the Secure MPAM feature page.

- MPAMCFG_CMIN_ns must be accessible from the Non-secure MPAM feature page.
- MPAMCFG_CMIN_rt must be accessible from the Root MPAM feature page.
- MPAMCFG_CMIN_rl must be accessible from the Realm MPAM feature page.

MPAMCFG_CMIN_s, MPAMCFG_CMIN_ns, MPAMCFG_CMIN_rt, and MPAMCFG_CMIN_rl must be separate registers:

- The Secure instance (MPAMCFG_CMIN_s) accesses the cache minimum capacity partitioning used for Secure PARTIDs.
- The Non-secure instance (MPAMCFG_CMIN_ns) accesses the cache minimum capacity partitioning used for Non-secure PARTIDs.
- The Root instance (MPAMCFG_CMIN_rt) accesses the cache minimum capacity partitioning used for Root PARTIDs.
- The Realm instance (MPAMCFG_CMIN_rl) accesses the cache minimum capacity partitioning used for Realm PARTIDs.

When RIS is implemented, loads and stores to MPAMCFG_CMIN access the cache minimum capacity partitioning configuration settings for the cache resource instance selected by [MPAMCFG_PART_SEL.RIS](#) and the PARTID selected by [MPAMCFG_PART_SEL.PARTID_SEL](#).

When RIS is not implemented, loads and stores to MPAMCFG_CMIN access the cache minimum capacity partitioning configuration settings for the PARTID selected by [MPAMCFG_PART_SEL.PARTID_SEL](#).

When PARTID narrowing is implemented, loads and stores to MPAMCFG_CMIN access the cache minimum capacity partitioning configuration settings for the internal PARTID selected by [MPAMCFG_PART_SEL.PARTID_SEL](#), and [MPAMCFG_PART_SEL.INTERNAL](#) must be 1.

When PARTID narrowing is not implemented, loads and stores to MPAMCFG_CMIN access the cache minimum capacity partitioning configuration settings for the request PARTID selected by [MPAMCFG_PART_SEL.PARTID_SEL](#), and [MPAMCFG_PART_SEL.INTERNAL](#) must be 0.

MPAMCFG_CMIN can be accessed through its memory-mapped interface:

Component	Frame	Offset	Instance
MPAM	MPAMF_BASE_s	0x0110	MPAMCFG_CMIN_s

Accesses to this interface are RW.

MPAMCFG_CMIN can be accessed through its memory-mapped interface:

Component	Frame	Offset	Instance
MPAM	MPAMF_BASE_ns	0x0110	MPAMCFG_CMIN_ns

Accesses to this interface are RW.

MPAMCFG_CMIN can be accessed through its memory-mapped interface:

Component	Frame	Offset	Instance
MPAM	MPAMF_BASE_rt	0x0110	MPAMCFG_CMIN_rt

When FEAT_RME is implemented, accesses to this interface are RW.

MPAMCFG_CMIN can be accessed through its memory-mapped interface:

Component	Frame	Offset	Instance
MPAM	MPAMF_BASE_r1	0x0110	MPAMCFG_CMIN_r1

When FEAT_RME is implemented, accesses to this interface are RW.

11.4.4 MPAMCFG_CPBM<n>, MPAM Cache Portion Bitmap Partition Configuration Register, n = 0 - 1023

The MPAMCFG_CPBM<n> characteristics are:

Purpose

The MPAMCFG_CPBM<n> register array gives access to the cache portion bitmap. Each register in the array is a read/write register that configures the cache portions numbered from <n * 32> to <31 + (n * 32)> that a PARTID is allowed to allocate.

After setting [MPAMCFG_PART_SEL](#) with a PARTID, software writes to the MPAMCFG_CPBM<n> register to configure which cache portions the PARTID is allowed to allocate.

The MPAMCFG_CPBM<n> register that contains the bitmap bit corresponding to cache portion p has n equal to $\lfloor p/32 \rfloor$. The field, P<x>, of that MPAMCFG_CPBM<n> register that contains the bitmap bit corresponding to cache portion p has x equal to $p \% 32$.

MPAMCFG_CPBM<n>_s controls cache portions for the Secure PARTID selected by the Secure instance of [MPAMCFG_PART_SEL](#). MPAMCFG_CPBM<n>_ns controls the cache portions for the Non-secure PARTID selected by the Non-secure instance of [MPAMCFG_PART_SEL](#).

MPAMCFG_CPBM<n>_rt controls cache portions for the Root PARTID selected by the Root instance of [MPAMCFG_PART_SEL](#). MPAMCFG_CPBM<n>_rl controls the cache portions for the Realm PARTID selected by the Non-secure instance of [MPAMCFG_PART_SEL](#).

If [MPAMF_IDR.HAS_RIS](#) is 1, the control settings accessed are those of the resource instance currently selected by [MPAMCFG_PART_SEL.RIS](#) and the PARTID selected by [MPAMCFG_PART_SEL.PARTID_SEL](#).

Configurations

The power domain of MPAMCFG_CPBM<n> is IMPLEMENTATION DEFINED.

This register is present only when [FEAT_MPAM](#) is implemented and [MPAMF_IDR.HAS_CPOR_PART](#) == 1. Otherwise, direct accesses to MPAMCFG_CPBM<n> are RES0.

The power and reset domain of each MSC component is specific to that component.

Attributes

MPAMCFG_CPBM<n> is a 32-bit register.

Field descriptions

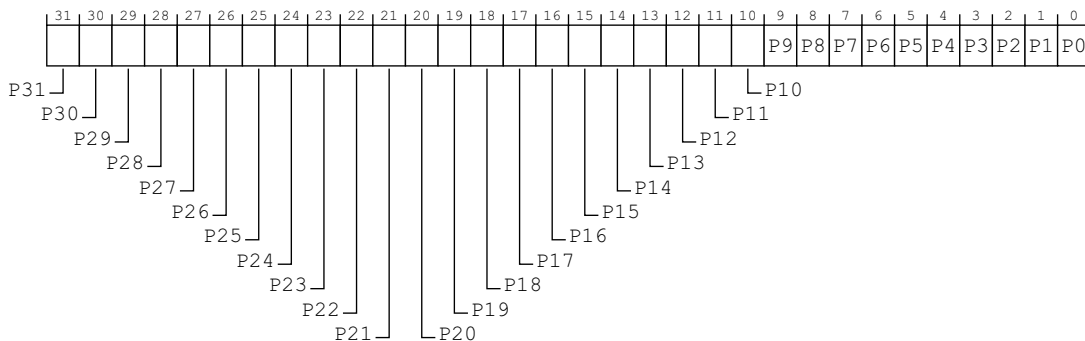

P<x>, bit [x], for x = 31 to 0

Portion allocation control bit. Each cache portion allocation control bit, MPAMCFG_CPBM<n>.P<x>, grants permission to the PARTID selected by [MPAMCFG_PART_SEL](#) to allocate cache lines within cache portion <n*32> + x.

0b0 The PARTID is not permitted to allocate into cache portion <n * 32> + x.

0b1 The PARTID is permitted to allocate within cache portion <n * 32> + x.

The number of bits in the cache portion partitioning bit map of this component is given in [MPAMF_CPOR_IDR.CPBM_WD](#). [MPAMF_CPOR_IDR.CPBM_WD](#) contains a value from 1 to 2¹⁵, inclusive. Values of [MPAMF_CPOR_IDR.CPBM_WD](#) greater than 32 require an array of 32-bit [MPAMCFG_CPBM<n>](#) registers to access the cache portion bitmap, up to 1024 registers.

When (n * 32) + x > UInt(MPAMF_CPOR_IDR.CPBM_WD), access to this field is RES0.

Accessing the MPAMCFG_CPBM<n>:

This register is within the MPAM feature page memory frames.

In a system that supports Secure, Non-secure, Root, and Realm memory maps, there must be MPAM feature pages in all four address maps:

- MPAMCFG_CPBM<n>_s must be accessible from the Secure MPAM feature page.
- MPAMCFG_CPBM<n>_ns must be accessible from the Non-secure MPAM feature page.
- MPAMCFG_CPBM<n>_rt must be accessible from the Root MPAM feature page.
- MPAMCFG_CPBM<n>_rl must be accessible from the Realm MPAM feature page.

MPAMCFG_CPBM<n>_s, MPAMCFG_CPBM<n>_ns, MPAMCFG_CPBM<n>_rt, and MPAMCFG_CPBM<n>_rl must be separate registers:

- The Secure instance (MPAMCFG_CPBM<n>_s) accesses the cache portion bitmap used for Secure PARTIDs.
- The Non-secure instance (MPAMCFG_CPBM<n>_ns) accesses the cache portion bitmap used for Non-secure PARTIDs.
- The Root instance (MPAMCFG_CPBM<n>_rt) accesses the cache portion bitmap used for Root PARTIDs.
- The Realm instance (MPAMCFG_CPBM<n>_rl) accesses the cache portion bitmap used for Realm PARTIDs.

When RIS is implemented, loads and stores to MPAMCFG_CPBM<n> access the cache portion bitmap configuration settings for the cache resource instance selected by [MPAMCFG_PART_SEL.RIS](#) and the PARTID selected by [MPAMCFG_PART_SEL.PARTID_SEL](#).

When RIS is not implemented, loads and stores to MPAMCFG_CPBM<n> access the cache portion bitmap configuration settings for the PARTID selected by [MPAMCFG_PART_SEL.PARTID_SEL](#).

When PARTID narrowing is implemented, loads and stores to MPAMCFG_CPBM<n> access the cache portion bitmap configuration settings for the internal PARTID selected by [MPAMCFG_PART_SEL.PARTID_SEL](#), and [MPAMCFG_PART_SEL.INTERNAL](#) must be 1.

When PARTID narrowing is not implemented, loads and stores to MPAMCFG_CPBM<n> access the cache portion bitmap configuration settings for the request PARTID selected by [MPAMCFG_PART_SEL.PARTID_SEL](#), and [MPAMCFG_PART_SEL.INTERNAL](#) must be 0.

MPAMCFG_CPBM<n> can be accessed through its memory-mapped interface:

Component	Frame	Offset	Instance
MPAM	MPAMF_BASE_s	0x1000 + (4 * n)	MPAMCFG_CPBM<n>_s

Accesses to this interface are RW.

MPAMCFG_CPBM<n> can be accessed through its memory-mapped interface:

Component	Frame	Offset	Instance
MPAM	MPAMF_BASE_ns	0x1000 + (4 * n)	MPAMCFG_CPBM<n>_ns

Accesses to this interface are RW.

MPAMCFG_CPBM<n> can be accessed through its memory-mapped interface:

Component	Frame	Offset	Instance
MPAM	MPAMF_BASE_rt	0x1000 + (4 * n)	MPAMCFG_CPBM<n>_rt

When FEAT_RME is implemented, accesses to this interface are RW.

MPAMCFG_CPBM<n> can be accessed through its memory-mapped interface:

Component	Frame	Offset	Instance
MPAM	MPAMF_BASE_rl	0x1000 + (4 * n)	MPAMCFG_CPBM<n>_rl

When FEAT_RME is implemented, accesses to this interface are RW.

11.4.5 MPAMCFG_DIS, MPAM Partition Configuration Disable Register

The MPAMCFG_DIS characteristics are:

Purpose

Disables a PARTID configuration as set in other MPAMCFG registers.

MPAMCFG_DIS_s disables a Secure PARTID. MPAMCFG_DIS_ns disables a Non-secure PARTID. MPAMCFG_DIS_rl disables a Realm PARTID. MPAMCFG_DIS_rt disables a Root PARTID.

Configurations

The power domain of MPAMCFG_DIS is IMPLEMENTATION DEFINED.

This register is present only when (FEAT_MPAMv0p1 is implemented or FEAT_MPAMv1p1 is implemented) and MPAMF_IDR.HAS_ENDIS == 1. Otherwise, direct accesses to MPAMCFG_DIS are RES0.

Attributes

MPAMCFG_DIS is a 32-bit register.

Field descriptions

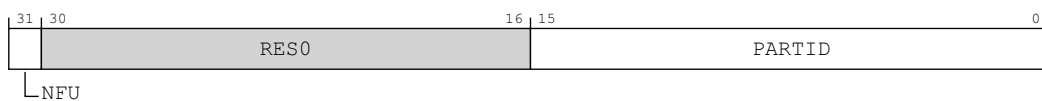

NFU, bit [31]

No Future Use.

0b0 Control settings of the disabled PARTID must be retained.

0b1 Control settings of the disabled PARTID may take an UNKNOWN value.

Bits [30:16]

Reserved, RES0.

PARTID, bits [15:0]

Selects the PARTID to disable.

Accessing the MPAMCFG_DIS:

This register is within the MPAM feature page memory frames.

In a system that supports Secure, Non-secure, Root, and Realm memory maps, there must be MPAM feature pages in all four address maps:

- MPAMCFG_DIS_s must be accessible from the Secure MPAM feature page.
- MPAMCFG_DIS_ns must be accessible from the Non-secure MPAM feature page.
- MPAMCFG_DIS_rt must be accessible from the Root MPAM feature page.
- MPAMCFG_DIS_rl must be accessible from the Realm MPAM feature page.

MPAMCFG_DIS_s, MPAMCFG_DIS_ns, MPAMCFG_DIS_rt, and MPAMCFG_DIS_rl must be separate registers:

- The Secure instance (MPAMCFG_DIS_s) accesses the PARTID disable used for Secure PARTIDs.

- The Non-secure instance (MPAMCFG_DIS_ns) accesses the PARTID disable used for Non-secure PARTIDs.
- The Root instance (MPAMCFG_DIS_rt) accesses the PARTID disable used for Root PARTIDs.
- The Realm instance (MPAMCFG_DIS_rl) accesses the PARTID disable used for Realm PARTIDs.

When RIS is implemented, loads and stores to MPAMCFG_DIS access the PARTID disable configuration settings for the PARTID disable resource instance selected by MPAMCFG_PART_SEL.RIS and the PARTID selected by MPAMCFG_PART_SEL.PARTID_SEL.

When RIS is not implemented, loads and stores to MPAMCFG_DIS access the PARTID disable configuration settings for the PARTID selected by MPAMCFG_PART_SEL.PARTID_SEL.

When PARTID narrowing is implemented, loads and stores to MPAMCFG_DIS access the PARTID disable configuration settings for the internal PARTID selected by MPAMCFG_PART_SEL.PARTID_SEL, and MPAMCFG_PART_SEL.INTERNAL must be 1.

When PARTID narrowing is not implemented, loads and stores to MPAMCFG_DIS access the PARTID disable configuration settings for the request PARTID selected by MPAMCFG_PART_SEL.PARTID_SEL, and MPAMCFG_PART_SEL.INTERNAL must be 0.

MPAMCFG_DIS can be accessed through its memory-mapped interface:

Component	Frame	Offset	Instance
MPAM	MPAMF_BASE_s	0x0310	MPAMCFG_DIS_s

Accesses to this interface are WO/RAZ.

MPAMCFG_DIS can be accessed through its memory-mapped interface:

Component	Frame	Offset	Instance
MPAM	MPAMF_BASE_ns	0x0310	MPAMCFG_DIS_ns

Accesses to this interface are WO/RAZ.

MPAMCFG_DIS can be accessed through its memory-mapped interface:

Component	Frame	Offset	Instance
MPAM	MPAMF_BASE_rt	0x0310	MPAMCFG_DIS_rt

When FEAT_RME is implemented, accesses to this interface are WO/RAZ.

MPAMCFG_DIS can be accessed through its memory-mapped interface:

Component	Frame	Offset	Instance
MPAM	MPAMF_BASE_rl	0x0310	MPAMCFG_DIS_rl

When FEAT_RME is implemented, accesses to this interface are WO/RAZ.

11.4.6 MPAMCFG_EN, MPAM Partition Configuration Enable Register

The MPAMCFG_EN characteristics are:

Purpose

Enables a PARTID configuration as set in other MPAMCFG registers.

MPAMCFG_EN_s enables a Secure PARTID. MPAMCFG_EN_ns enables a Non-secure PARTID. MPAMCFG_EN_rl enables a Realm PARTID. MPAMCFG_EN_rt enables a Root PARTID.

Configurations

The power domain of MPAMCFG_EN is IMPLEMENTATION DEFINED.

This register is present only when (FEAT_MPAMv0p1 is implemented or FEAT_MPAMv1p1 is implemented) and MPAMF_IDR.HAS_ENDIS == 1. Otherwise, direct accesses to MPAMCFG_EN are RES0.

Attributes

MPAMCFG_EN is a 32-bit register.

Field descriptions

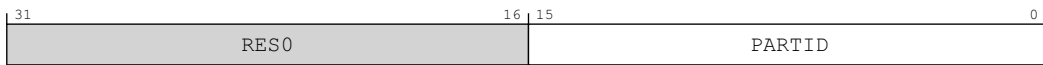

Bits [31:16]

Reserved, RES0.

PARTID, bits [15:0]

Selects the PARTID to enable.

Accessing the MPAMCFG_EN:

This register is within the MPAM feature page memory frames.

In a system that supports Secure, Non-secure, Root, and Realm memory maps, there must be MPAM feature pages in all four address maps:

- MPAMCFG_EN_s must be accessible from the Secure MPAM feature page.
- MPAMCFG_EN_ns must be accessible from the Non-secure MPAM feature page.
- MPAMCFG_EN_rt must be accessible from the Root MPAM feature page.
- MPAMCFG_EN_rl must be accessible from the Realm MPAM feature page.

MPAMCFG_EN_s, MPAMCFG_EN_ns, MPAMCFG_EN_rt, and MPAMCFG_EN_rl must be separate registers:

- The Secure instance (MPAMCFG_EN_s) accesses the PARTID enable used for Secure PARTIDs.
- The Non-secure instance (MPAMCFG_EN_ns) accesses the PARTID enable used for Non-secure PARTIDs.
- The Root instance (MPAMCFG_EN_rt) accesses the PARTID enable used for Root PARTIDs.
- The Realm instance (MPAMCFG_EN_rl) accesses the PARTID enable used for Realm PARTIDs.

When RIS is implemented, loads and stores to MPAMCFG_EN access the PARTID enable configuration settings for the PARTID enable resource instance selected by [MPAMCFG_PART_SEL.RIS](#) and the PARTID selected by [MPAMCFG_PART_SEL.PARTID_SEL](#).

When RIS is not implemented, loads and stores to MPAMCFG_EN access the PARTID enable configuration settings for the PARTID selected by MPAMCFG_PART_SEL.PARTID_SEL.

When PARTID narrowing is implemented, loads and stores to MPAMCFG_EN access the PARTID enable configuration settings for the internal PARTID selected by MPAMCFG_PART_SEL.PARTID_SEL, and MPAMCFG_PART_SEL.INTERNAL must be 1.

When PARTID narrowing is not implemented, loads and stores to MPAMCFG_EN access the PARTID enable configuration settings for the request PARTID selected by MPAMCFG_PART_SEL.PARTID_SEL, and MPAMCFG_PART_SEL.INTERNAL must be 0.

MPAMCFG_EN can be accessed through its memory-mapped interface:

Component	Frame	Offset	Instance
MPAM	MPAMF_BASE_s	0x0300	MPAMCFG_EN_s

Accesses to this interface are WO/RAZ.

MPAMCFG_EN can be accessed through its memory-mapped interface:

Component	Frame	Offset	Instance
MPAM	MPAMF_BASE_ns	0x0300	MPAMCFG_EN_ns

Accesses to this interface are WO/RAZ.

MPAMCFG_EN can be accessed through its memory-mapped interface:

Component	Frame	Offset	Instance
MPAM	MPAMF_BASE_rt	0x0300	MPAMCFG_EN_rt

When FEAT_RME is implemented, accesses to this interface are WO/RAZ.

MPAMCFG_EN can be accessed through its memory-mapped interface:

Component	Frame	Offset	Instance
MPAM	MPAMF_BASE_rl	0x0300	MPAMCFG_EN_rl

When FEAT_RME is implemented, accesses to this interface are WO/RAZ.

11.4.7 MPAMCFG_EN_FLAGS, MPAM Partition Configuration Enable Flags Register

The MPAMCFG_EN_FLAGS characteristics are:

Purpose

Enable flags for 32 PARTIDs.

MPAMCFG_EN_FLAGS_s gives read/write access to 32 Secure PARTIDs.

MPAMCFG_EN_FLAGS_ns gives read/write access to 32 Non-secure PARTIDs.

MPAMCFG_EN_FLAGS_rl gives read/write access to 32 Realm PARTIDs.

MPAMCFG_EN_FLAGS_rt gives read/write access to 32 Root PARTIDs.

Configurations

The power domain of MPAMCFG_EN_FLAGS is IMPLEMENTATION DEFINED.

This register is present only when (FEAT_MPAMv0p1 is implemented or FEAT_MPAMv1p1 is implemented) and MPAMF_IDR.HAS_ENDIS == 1. Otherwise, direct accesses to MPAMCFG_EN_FLAGS are RES0.

Attributes

MPAMCFG_EN_FLAGS is a 32-bit register.

Field descriptions

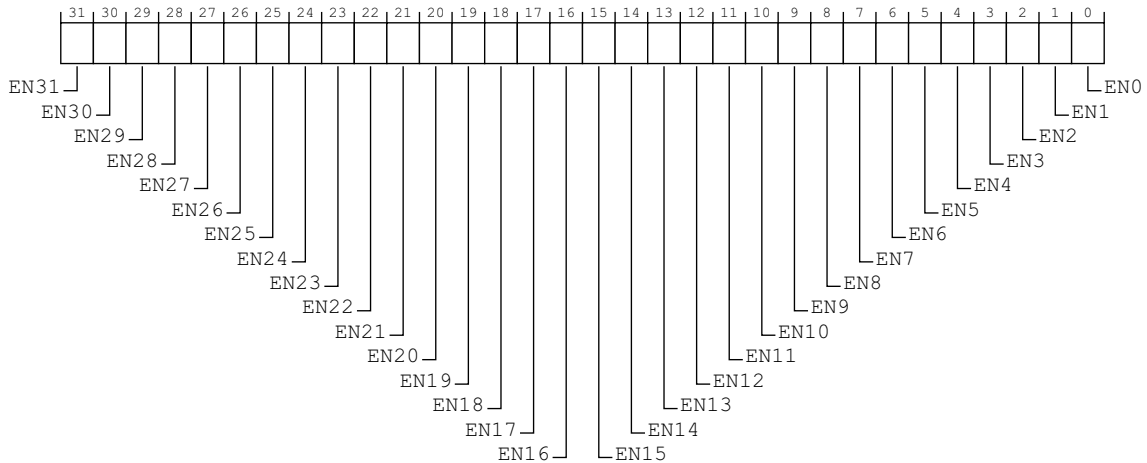

EN<x>, bit [x], for x = 31 to 0

PARTID Enable flags. The group of flags accessed is selected by `MPAMCFG_PART_SEL.PARTID & 0xFFE0` in bit [0] to `(MPAMCFG_PART_SEL.PARTID & 0xFFE0) + 31` in bit [31].

0b0 The PARTID is disabled.

0b1 The PARTID is enabled.

Each bit in `MPAMCFG_EN_FLAGS` gives access to the same state as controlled by `MPAMCFG_EN` and `MPAMCFG_DIS`.

Bits `MPAMCFG_EN_FLAGS.EN<x>`, where `(MPAMCFG_PART_SEL.PARTID & 0xFFE0) + x` is greater than `MPAMF_IDR.PARTID_MAX`, are not required to be implemented.

As with other partitioning controls, the enable flag for PARTID 0 must be reset to 0b1 (enabled).

Accessing the MPAMCFG_EN_FLAGS:

This register is within the MPAM feature page memory frames.

In a system that supports Secure, Non-secure, Root, and Realm memory maps, there must be MPAM feature pages in all four address maps:

- MPAMCFG_EN_FLAGS_s must be accessible from the Secure MPAM feature page.
- MPAMCFG_EN_FLAGS_ns must be accessible from the Non-secure MPAM feature page.
- MPAMCFG_EN_FLAGS_rt must be accessible from the Root MPAM feature page.
- MPAMCFG_EN_FLAGS_rl must be accessible from the Realm MPAM feature page.

MPAMCFG_EN_FLAGS_s, MPAMCFG_EN_FLAGS_ns, MPAMCFG_EN_FLAGS_rt, and MPAMCFG_EN_FLAGS_rl must be separate registers:

- The Secure instance (MPAMCFG_EN_FLAGS_s) accesses the PARTID enable used for Secure PARTIDs.
- The Non-secure instance (MPAMCFG_EN_FLAGS_ns) accesses the PARTID enable used for Non-secure PARTIDs.
- The Root instance (MPAMCFG_EN_FLAGS_rt) accesses the PARTID enable used for Root PARTIDs.
- The Realm instance (MPAMCFG_EN_FLAGS_rl) accesses the PARTID enable used for Realm PARTIDs.

When RIS is implemented, loads and stores to MPAMCFG_EN_FLAGS access the PARTID enable configuration settings for the PARTID enable resource instance selected by MPAMCFG_PART_SEL.RIS and the PARTID selected by MPAMCFG_PART_SEL.PARTID_SEL.

When RIS is not implemented, loads and stores to MPAMCFG_EN_FLAGS access the PARTID enable configuration settings for the PARTID selected by MPAMCFG_PART_SEL.PARTID_SEL.

When PARTID narrowing is implemented, loads and stores to MPAMCFG_EN_FLAGS access the PARTID enable configuration settings for the internal PARTID selected by MPAMCFG_PART_SEL.PARTID_SEL, and MPAMCFG_PART_SEL.INTERNAL must be 1.

When PARTID narrowing is not implemented, loads and stores to MPAMCFG_EN_FLAGS access the PARTID enable configuration settings for the request PARTID selected by MPAMCFG_PART_SEL.PARTID_SEL, and MPAMCFG_PART_SEL.INTERNAL must be 0.

MPAMCFG_EN_FLAGS can be accessed through its memory-mapped interface:

Component	Frame	Offset	Instance
MPAM	MPAMF_BASE_s	0x0320	MPAMCFG_EN_FLAGS_s

Accesses to this interface are RW.

MPAMCFG_EN_FLAGS can be accessed through its memory-mapped interface:

Component	Frame	Offset	Instance
MPAM	MPAMF_BASE_ns	0x0320	MPAMCFG_EN_FLAGS_ns

Accesses to this interface are RW.

MPAMCFG_EN_FLAGS can be accessed through its memory-mapped interface:

Component	Frame	Offset	Instance
MPAM	MPAMF_BASE_rt	0x0320	MPAMCFG_EN_FLAGS_rt

When FEAT_RME is implemented, accesses to this interface are RW.

MPAMCFG_EN_FLAGS can be accessed through its memory-mapped interface:

Component	Frame	Offset	Instance
MPAM	MPAMF_BASE_r1	0x0320	MPAMCFG_EN_FLAGS_r1

When FEAT_RME is implemented, accesses to this interface are RW.

11.4.8 MPAMCFG_INTPARTID, MPAM Internal PARTID Narrowing Configuration Register

The MPAMCFG_INTPARTID characteristics are:

Purpose

MPAMCFG_INTPARTID is a 32-bit read/write register that controls the mapping of the PARTID selected by [MPAMCFG_PART_SEL](#) into a narrower internal PARTID (intPARTID).

MPAMCFG_INTPARTID_s controls the mapping for the Secure PARTID selected by the Secure instance of [MPAMCFG_PART_SEL](#). MPAMCFG_INTPARTID_ns controls the mapping for the Non-secure PARTID selected by the Non-secure instance of [MPAMCFG_PART_SEL](#). MPAMCFG_INTPARTID_rt controls the mapping for the Root PARTID selected by the Root instance of [MPAMCFG_PART_SEL](#). MPAMCFG_INTPARTID_rl controls the mapping for the Realm PARTID selected by the Realm instance of [MPAMCFG_PART_SEL](#).

The MPAMCFG_INTPARTID register associates the request PARTID (reqPARTID) in the [MPAMCFG_PART_SEL](#) register with an internal PARTID (intPARTID) in this register. To set that association, store reqPARTID into the [MPAMCFG_PART_SEL](#) register and then store the intPARTID into the MPAMCFG_INTPARTID register. To read the association, store reqPARTID into the [MPAMCFG_PART_SEL](#) register and then read MPAMCFG_INTPARTID.

If the intPARTID stored into MPAMCFG_INTPARTID is out-of-range or does not have the INTERNAL bit set, the association of reqPARTID to intPARTID is not written and [MPAMF_ESR](#) is set to indicate an intPARTID_Range error.

If [MPAMCFG_PART_SEL](#).INTERNAL is 1 when MPAMCFG_INTPARTID is read or written, [MPAMF_ESR](#) is set to indicate an Unexpected_INTERNAL error.

Configurations

The power domain of MPAMCFG_INTPARTID is IMPLEMENTATION DEFINED.

This register is present only when FEAT_MPAM is implemented and [MPAMF_IDR.HAS_PARTID_NRW](#) == 1. Otherwise, direct accesses to MPAMCFG_INTPARTID are RES0.

The power and reset domain of each MSC component is specific to that component.

Attributes

MPAMCFG_INTPARTID is a 32-bit register.

Field descriptions

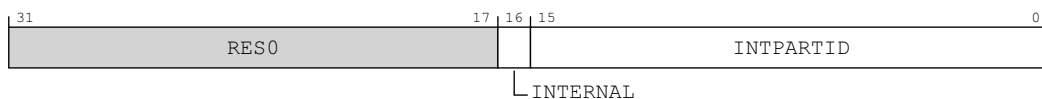

Bits [31:17]

Reserved, RES0.

INTERNAL, bit [16]

Internal PARTID flag.

This bit must be 1 when written to the register. If written as 0, the write will not update the reqPARTID to intPARTID association.

On a read of this register, the bit will always read the value last written.

INTPARTID, bits [15:0]

This field contains the intPARTID mapped to the reqPARTID in [MPAMCFG_PART_SEL](#).

The maximum intPARTID supported is [MPAMF_PARTID_NRW_IDR](#).INTPARTID_MAX.

Accessing the MPAMCFG_INTPARTID:

This register is within the MPAM feature page memory frames.

In a system that supports Secure, Non-secure, Root, and Realm memory maps, there must be MPAM feature pages in all four address maps:

- MPAMCFG_INTPARTID_s must be accessible from the Secure MPAM feature page.
- MPAMCFG_INTPARTID_ns must be accessible from the Non-secure MPAM feature page.
- MPAMCFG_INTPARTID_rt must be accessible from the Root MPAM feature page.
- MPAMCFG_INTPARTID_rl must be accessible from the Realm MPAM feature page.

MPAMCFG_INTPARTID_s, MPAMCFG_INTPARTID_ns, MPAMCFG_INTPARTID_rt, and MPAMCFG_INTPARTID_rl must be separate registers:

- The Secure instance (MPAMCFG_INTPARTID_s) accesses the PARTID narrowing used for Secure PARTIDs.
- The Non-secure instance (MPAMCFG_INTPARTID_ns) accesses the PARTID narrowing used for Non-secure PARTIDs.
- The Root instance (MPAMCFG_INTPARTID_rt) accesses the PARTID narrowing used for Root PARTIDs.
- The Realm instance (MPAMCFG_INTPARTID_rl) accesses the PARTID narrowing used for Realm PARTIDs.

When RIS is implemented, loads and stores to MPAMCFG_INTPARTID access the PARTID narrowing configuration settings without being affected by [MPAMCFG_PART_SEL](#).RIS.

Loads and stores to MPAMCFG_INTPARTID access the PARTID narrowing configuration settings for the request PARTID selected by [MPAMCFG_PART_SEL](#).PARTID_SEL, and [MPAMCFG_PART_SEL](#).INTERNAL must be 0.

MPAMCFG_INTPARTID can be accessed through its memory-mapped interface:

Component	Frame	Offset	Instance
MPAM	MPAMF_BASE_s	0x0600	MPAMCFG_INTPARTID_s

Accesses to this interface are RW.

MPAMCFG_INTPARTID can be accessed through its memory-mapped interface:

Component	Frame	Offset	Instance
MPAM	MPAMF_BASE_ns	0x0600	MPAMCFG_INTPARTID_ns

Accesses to this interface are RW.

MPAMCFG_INTPARTID can be accessed through its memory-mapped interface:

Component	Frame	Offset	Instance
MPAM	MPAMF_BASE_rt	0x0600	MPAMCFG_INTPARTID_rt

When FEAT_RME is implemented, accesses to this interface are RW.

MPAMCFG_INTPARTID can be accessed through its memory-mapped interface:

Component	Frame	Offset	Instance
MPAM	MPAMF_BASE_r1	0x0600	MPAMCFG_INTPARTID_r1

When FEAT_RME is implemented, accesses to this interface are RW.

11.4.9 MPAMCFG_MBW_MAX, MPAM Memory Bandwidth Maximum Partition Configuration Register

The MPAMCFG_MBW_MAX characteristics are:

Purpose

MPAMCFG_MBW_MAX is a 32-bit read/write register that controls the maximum fraction of memory bandwidth that the PARTID selected by [MPAMCFG_PART_SEL](#) is permitted to use.

MPAMCFG_MBW_MAX_s controls maximum bandwidth for the Secure PARTID selected by the Secure instance of [MPAMCFG_PART_SEL](#). MPAMCFG_MBW_MAX_ns controls the maximum bandwidth for the Non-secure PARTID selected by the Non-secure instance of [MPAMCFG_PART_SEL](#). MPAMCFG_MBW_MAX_rt controls the maximum bandwidth for the Root PARTID selected by the Root instance of [MPAMCFG_PART_SEL](#).

MPAMCFG_MBW_MAX_rl controls the maximum bandwidth for the Realm PARTID selected by the Realm instance of [MPAMCFG_PART_SEL](#).

A PARTID that has used more than MAX is given no access to additional bandwidth if HARDLIM == 1 or is given additional bandwidth only if there are no requests from PARTIDs that have not exceeded their MAX if HARDLIM == 0.

If [MPAMF_IDR.HAS_RIS](#) is 1, the control settings accessed are those of the resource instance currently selected by [MPAMCFG_PART_SEL.RIS](#) and the PARTID selected by [MPAMCFG_PART_SEL.PARTID_SEL](#).

Configurations

The power domain of MPAMCFG_MBW_MAX is IMPLEMENTATION DEFINED.

This register is present only when FEAT_MPAM is implemented, [MPAMF_IDR.HAS_MBW_PART](#) == 1 and [MPAMF_MBW_IDR.HAS_MAX](#) == 1. Otherwise, direct accesses to MPAMCFG_MBW_MAX are RES0.

The power and reset domain of each MSC component is specific to that component.

Attributes

MPAMCFG_MBW_MAX is a 32-bit register.

Field descriptions



HARDLIM, bit [31]

Hard bandwidth limiting.

0b0 When MAX bandwidth is exceeded, the partition contends with a low preference for downstream bandwidth beyond MAX.

0b1 When MAX bandwidth is exceeded, the partition does not use any more bandwidth until the memory bandwidth measurement for the partition falls below MAX.

Bits [30:16]

Reserved, RES0.

MAX, bits [15:0]

Memory maximum bandwidth allocated to the partition selected by [MPAMCFG_PART_SEL](#). MAX is in fixed-point fraction format. The fraction represents the portion of the total memory bandwidth capacity through the controlled component that the PARTID is permitted to allocate.

The implemented width of the fixed-point fraction is given in [MPAMF_MBW_IDR.BWA_WD](#). Unimplemented bits are RAZ/WI. The implemented bits of the MAX field are always to the left of the field. For example, if [BWA_WD](#) = 3, the implemented bits are [MPAMCFG_MBW_MAX\[15:13\]](#) and [MPAMCFG_MBW_MAX\[12:0\]](#) are unimplemented.

The fixed-point fraction MAX is less than 1. The implied binary point is between bits 15 and 16. This representation has as the largest fraction of the bandwidth that can be represented in an implementation with w implemented bits is 1.0 minus one half to the power w.

Accessing the MPAMCFG_MBW_MAX:

This register is within the MPAM feature page memory frames.

In a system that supports Secure, Non-secure, Root, and Realm memory maps, there must be MPAM feature pages in all four address maps:

- [MPAMCFG_MBW_MAX_s](#) must be accessible from the Secure MPAM feature page.
- [MPAMCFG_MBW_MAX_ns](#) must be accessible from the Non-secure MPAM feature page.
- [MPAMCFG_MBW_MAX_rt](#) must be accessible from the Root MPAM feature page.
- [MPAMCFG_MBW_MAX_rl](#) must be accessible from the Realm MPAM feature page.

[MPAMCFG_MBW_MAX_s](#), [MPAMCFG_MBW_MAX_ns](#), [MPAMCFG_MBW_MAX_rt](#), and [MPAMCFG_MBW_MAX_rl](#) must be separate registers:

- The Secure instance ([MPAMCFG_MBW_MAX_s](#)) accesses the memory maximum bandwidth partitioning used for Secure PARTIDs.
- The Non-secure instance ([MPAMCFG_MBW_MAX_ns](#)) accesses the memory maximum bandwidth partitioning used for Non-secure PARTIDs.
- The Root instance ([MPAMCFG_MBW_MAX_rt](#)) accesses the memory maximum bandwidth partitioning used for Root PARTIDs.
- The Realm instance ([MPAMCFG_MBW_MAX_rl](#)) accesses the memory maximum bandwidth partitioning used for Realm PARTIDs.

When RIS is implemented, loads and stores to [MPAMCFG_MBW_MAX](#) access the memory maximum bandwidth partitioning configuration settings for the bandwidth resource instance selected by [MPAMCFG_PART_SEL.RIS](#) and the PARTID selected by [MPAMCFG_PART_SEL.PARTID_SEL](#).

When RIS is not implemented, loads and stores to [MPAMCFG_MBW_MAX](#) access the memory maximum bandwidth partitioning configuration settings for the PARTID selected by [MPAMCFG_PART_SEL.PARTID_SEL](#).

When PARTID narrowing is implemented, loads and stores to [MPAMCFG_MBW_MAX](#) access the memory maximum bandwidth partitioning configuration settings for the internal PARTID selected by [MPAMCFG_PART_SEL.PARTID_SEL](#), and [MPAMCFG_PART_SEL.INTERNAL](#) must be 1.

When PARTID narrowing is not implemented, loads and stores to [MPAMCFG_MBW_MAX](#) access the memory maximum bandwidth partitioning configuration settings for the request PARTID selected by [MPAMCFG_PART_SEL.PARTID_SEL](#), and [MPAMCFG_PART_SEL.INTERNAL](#) must be 0.

[MPAMCFG_MBW_MAX](#) can be accessed through its memory-mapped interface:

Component	Frame	Offset	Instance
MPAM	MPAMF_BASE_s	0x0208	MPAMCFG_MBW_MAX_s

Accesses to this interface are RW.

MPAMCFG_MBW_MAX can be accessed through its memory-mapped interface:

Component	Frame	Offset	Instance
MPAM	MPAMF_BASE_ns	0x0208	MPAMCFG_MBW_MAX_ns

Accesses to this interface are RW.

MPAMCFG_MBW_MAX can be accessed through its memory-mapped interface:

Component	Frame	Offset	Instance
MPAM	MPAMF_BASE_rt	0x0208	MPAMCFG_MBW_MAX_rt

When FEAT_RME is implemented, accesses to this interface are RW.

MPAMCFG_MBW_MAX can be accessed through its memory-mapped interface:

Component	Frame	Offset	Instance
MPAM	MPAMF_BASE_rl	0x0208	MPAMCFG_MBW_MAX_rl

When FEAT_RME is implemented, accesses to this interface are RW.

11.4.10 MPAMCFG_MBW_MIN, MPAM Memory Bandwidth Minimum Partition Configuration Register

The MPAMCFG_MBW_MIN characteristics are:

Purpose

MPAMCFG_MBW_MIN is a 32-bit read/write register that controls the minimum fraction of memory bandwidth that the PARTID selected by MPAMCFG_PART_SEL is permitted to use.

MPAMCFG_MBW_MIN_s controls the minimum bandwidth for the Secure PARTID selected by the Secure instance of MPAMCFG_PART_SEL. MPAMCFG_MBW_MIN_ns controls the minimum bandwidth for the Non-secure PARTID selected by the Non-secure instance of MPAMCFG_PART_SEL. MPAMCFG_MBW_MIN_rt controls the minimum bandwidth for the Root PARTID selected by the Root instance of MPAMCFG_PART_SEL.

MPAMCFG_MBW_MIN_rl controls the minimum bandwidth for the Realm PARTID selected by the Realm instance of MPAMCFG_PART_SEL.

A PARTID that has used less than MIN is given preferential access to bandwidth.

If MPAMF_IDR.HAS_RIS is 1, the control settings accessed are those of the resource instance currently selected by MPAMCFG_PART_SEL.RIS and the PARTID selected by MPAMCFG_PART_SEL.PARTID_SEL.

Configurations

The power domain of MPAMCFG_MBW_MIN is IMPLEMENTATION DEFINED.

This register is present only when FEAT_MPAM is implemented, MPAMF_IDR.HAS_MBW_PART == 1 and MPAMF_MBW_IDR.HAS_MIN == 1. Otherwise, direct accesses to MPAMCFG_MBW_MIN are RES0.

The power and reset domain of each MSC component is specific to that component.

Attributes

MPAMCFG_MBW_MIN is a 32-bit register.

Field descriptions



Bits [31:16]

Reserved, RES0.

MIN, bits [15:0]

Memory minimum bandwidth allocated to the partition selected by MPAMCFG_PART_SEL. MIN is in fixed-point fraction format. The fraction represents the portion of the total memory bandwidth capacity through the controlled component that the PARTID is permitted to allocate.

The implemented width of the fixed-point fraction is given in MPAMF_MBW_IDR.BWA_WD. Unimplemented bits are RAZ/WI. The implemented bits of the MIN field are always to the left of the field. For example, if BWA_WD = 4, the implemented bits are MPAMCFG_MBW_MIN[15:12] and MPAMCFG_MBW_MIN[11:0] are unimplemented.

The fixed-point fraction MIN is less than 1. The implied binary point is between bits 15 and 16. This representation has as the largest fraction of the bandwidth that can be represented in an implementation with w implemented bits is 1.0 minus one half to the power w.

Accessing the MPAMCFG_MBW_MIN:

This register is within the MPAM feature page memory frames.

In a system that supports Secure, Non-secure, Root, and Realm memory maps, there must be MPAM feature pages in all four address maps:

- MPAMCFG_MBW_MIN_s must be accessible from the Secure MPAM feature page.
- MPAMCFG_MBW_MIN_ns must be accessible from the Non-secure MPAM feature page.
- MPAMCFG_MBW_MIN_rt must be accessible from the Root MPAM feature page.
- MPAMCFG_MBW_MIN_rl must be accessible from the Realm MPAM feature page.

MPAMCFG_MBW_MIN_s, MPAMCFG_MBW_MIN_ns, MPAMCFG_MBW_MIN_rt, and MPAMCFG_MBW_MIN_rl must be separate registers:

- The Secure instance (MPAMCFG_MBW_MIN_s) accesses the memory minimum bandwidth partitioning used for Secure PARTIDs.
- The Non-secure instance (MPAMCFG_MBW_MIN_ns) accesses the memory minimum bandwidth partitioning used for Non-secure PARTIDs.
- The Root instance (MPAMCFG_MBW_MIN_rt) accesses the memory minimum bandwidth partitioning used for Root PARTIDs.
- The Realm instance (MPAMCFG_MBW_MIN_rl) accesses the memory minimum bandwidth partitioning used for Realm PARTIDs.

When RIS is implemented, loads and stores to MPAMCFG_MBW_MIN access the memory minimum bandwidth partitioning configuration settings for the bandwidth resource instance selected by MPAMCFG_PART_SEL.RIS and the PARTID selected by MPAMCFG_PART_SEL.PARTID_SEL.

When RIS is not implemented, loads and stores to MPAMCFG_MBW_MIN access the memory minimum bandwidth partitioning configuration settings for the PARTID selected by MPAMCFG_PART_SEL.PARTID_SEL.

When PARTID narrowing is implemented, loads and stores to MPAMCFG_MBW_MIN access the memory minimum bandwidth partitioning configuration settings for the internal PARTID selected by MPAMCFG_PART_SEL.PARTID_SEL, and MPAMCFG_PART_SEL.INTERNAL must be 1.

When PARTID narrowing is not implemented, loads and stores to MPAMCFG_MBW_MIN access the memory minimum bandwidth partitioning configuration settings for the request PARTID selected by MPAMCFG_PART_SEL.PARTID_SEL, and MPAMCFG_PART_SEL.INTERNAL must be 0.

MPAMCFG_MBW_MIN can be accessed through its memory-mapped interface:

Component	Frame	Offset	Instance
MPAM	MPAMF_BASE_s	0x0200	MPAMCFG_MBW_MIN_s

Accesses to this interface are RW.

MPAMCFG_MBW_MIN can be accessed through its memory-mapped interface:

Component	Frame	Offset	Instance
MPAM	MPAMF_BASE_ns	0x0200	MPAMCFG_MBW_MIN_ns

Accesses to this interface are RW.

MPAMCFG_MBW_MIN can be accessed through its memory-mapped interface:

Component	Frame	Offset	Instance
MPAM	MPAMF_BASE_rt	0x0200	MPAMCFG_MBW_MIN_rt

When FEAT_RME is implemented, accesses to this interface are RW.

MPAMCFG_MBW_MIN can be accessed through its memory-mapped interface:

Component	Frame	Offset	Instance
MPAM	MPAMF_BASE_rl	0x0200	MPAMCFG_MBW_MIN_rl

When FEAT_RME is implemented, accesses to this interface are RW.

11.4.11 MPAMCFG_MBW_PBM<n>, MPAM Bandwidth Portion Bitmap Partition Configuration Register, n = 0 - 127

The MPAMCFG_MBW_PBM<n> characteristics are:

Purpose

The MPAMCFG_MBW_PBM<n> register array gives access to the memory bandwidth portion bitmap. Each register in the array is a read/write register that configures whether a PARTID is allowed to allocate bandwidth portions within a range.

The range of portions covered in MPAMCFG_MBW_PBM<n> is from portion <32*n> to portion <32*n + 31>.

After setting MPAMCFG_PART_SEL with a PARTID, software writes to one or more of the MPAMCFG_MBW_PBM<n> registers to configure with bandwidth portions the PARTID is allowed to allocate.

The MPAMCFG_MBW_PBM<n> register that contains the bitmap bit corresponding to memory bandwidth portion p has n equal to p[11:5]. The field, P<x> of that MPAMCFG_MBW_PBM<n> register that contains the bitmap bit corresponding to memory bandwidth portion p has <x> equal to p[4:0].

The MPAMCFG_MBW_PBM<n>_s registers control the bandwidth portion bitmap for the Secure PARTID selected by the Secure instance of MPAMCFG_PART_SEL. The MPAMCFG_MBW_PBM<n>_ns registers control the bandwidth portion bitmap for the Non-secure PARTID selected by the Non-secure instance of MPAMCFG_PART_SEL. The MPAMCFG_MBW_PBM<n>_rt registers control the bandwidth portion bitmap for the Root PARTID selected by the Root instance of MPAMCFG_PART_SEL. The MPAMCFG_MBW_PBM<n>_rl registers control the bandwidth portion bitmap for the Realm PARTID selected by the Realm instance of MPAMCFG_PART_SEL.

If MPAMF_IDR.HAS_RIS is 1, the control settings accessed are those of the resource instance currently selected by MPAMCFG_PART_SEL.RIS and the PARTID selected by MPAMCFG_PART_SEL.PARTID_SEL.

Configurations

The power domain of MPAMCFG_MBW_PBM<n> is IMPLEMENTATION DEFINED.

This register is present only when FEAT_MPAM is implemented, MPAMF_IDR.HAS_MBW_PART == 1 and MPAMF_MBW_IDR.HAS_PBM == 1. Otherwise, direct accesses to MPAMCFG_MBW_PBM<n> are RES0.

The power and reset domain of each MSC component is specific to that component.

Attributes

MPAMCFG_MBW_PBM<n> is a 32-bit register.

Field descriptions

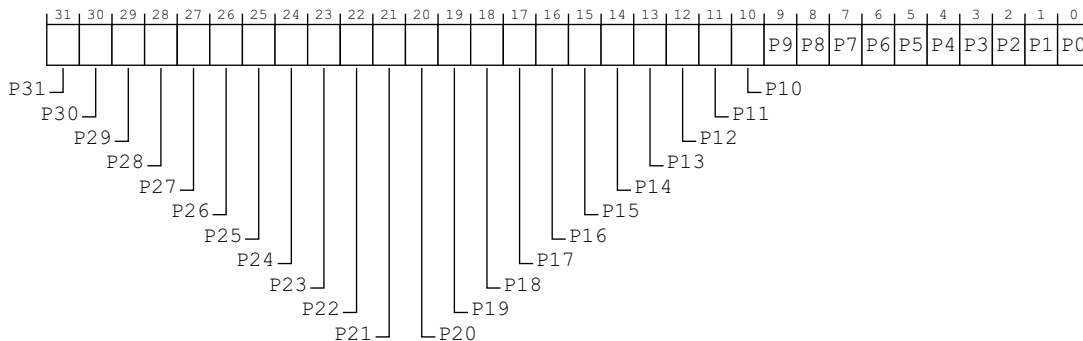

P<x>, bit [x], for x = 31 to 0

Portion allocation control bit. Each bandwidth portion allocation control bit MPAMCFG_MBW_PBM<n>.P<x> grants permission to the PARTID selected by MPAMCFG_PART_SEL to allocate bandwidth within bandwidth portion <32*n> + <x>.

0b0 The PARTID is not permitted to allocate into bandwidth portion <32*n> + <x>.

0b1 The PARTID is permitted to allocate within bandwidth portion <32*n> + <x>.

The number of bits in the bandwidth portion partitioning bit map of this component is given in MPAMF_MBW_IDR.BWPBM_WD. BWPBM_WD contains a value from 1 to 2¹², inclusive. Values of MPAMF_MBW_IDR.BWPBM_WD greater than 32 require a group of 32-bit registers to access the bandwidth portion bitmap, up to 128 32-bit registers.

When $(n * 32) + x > \text{UInt}(\text{MPAMF_MBW_IDR.BWPBM_WD})$, access to this field is RES0.

Accessing the MPAMCFG_MBW_PBM<n>:

This register is within the MPAM feature page memory frames.

In a system that supports Secure, Non-secure, Root, and Realm memory maps, there must be MPAM feature pages in all four address maps:

- MPAMCFG_MBW_PBM<n>_s must be accessible from the Secure MPAM feature page.
- MPAMCFG_MBW_PBM<n>_ns must be accessible from the Non-secure MPAM feature page.
- MPAMCFG_MBW_PBM<n>_rt must be accessible from the Root MPAM feature page.
- MPAMCFG_MBW_PBM<n>_rl must be accessible from the Realm MPAM feature page.

MPAMCFG_MBW_PBM<n>_s, MPAMCFG_MBW_PBM<n>_ns, MPAMCFG_MBW_PBM<n>_rt, and MPAMCFG_MBW_PBM<n>_rl must be separate registers:

- The Secure instance (MPAMCFG_MBW_PBM<n>_s) accesses the memory bandwidth portion bitmap used for Secure PARTIDs.
- The Non-secure instance (MPAMCFG_MBW_PBM<n>_ns) accesses the memory bandwidth portion bitmap used for Non-secure PARTIDs.
- The Root instance (MPAMCFG_MBW_PBM<n>_rt) accesses the memory bandwidth portion bitmap used for Root PARTIDs.
- The Realm instance (MPAMCFG_MBW_PBM<n>_rl) accesses the memory bandwidth portion bitmap used for Realm PARTIDs.

When RIS is implemented, loads and stores to MPAMCFG_MBW_PBM<n> access the memory bandwidth portion bitmap configuration settings for the bandwidth resource instance selected by MPAMCFG_PART_SEL.RIS and the PARTID selected by MPAMCFG_PART_SEL.PARTID_SEL.

When RIS is not implemented, loads and stores to MPAMCFG_MBW_PBM<n> access the memory bandwidth portion bitmap configuration settings for the PARTID selected by MPAMCFG_PART_SEL.PARTID_SEL.

When PARTID narrowing is implemented, loads and stores to MPAMCFG_MBW_PBM<n> access the memory bandwidth portion bitmap configuration settings for the internal PARTID selected by MPAMCFG_PART_SEL.PARTID_SEL, and MPAMCFG_PART_SEL.INTERNAL must be 1.

When PARTID narrowing is not implemented, loads and stores to MPAMCFG_MBW_PBM<n> access the memory bandwidth portion bitmap configuration settings for the request PARTID selected by MPAMCFG_PART_SEL.PARTID_SEL, and MPAMCFG_PART_SEL.INTERNAL must be 0.

MPAMCFG_MBW_PBM<n> can be accessed through its memory-mapped interface:

Component	Frame	Offset	Instance
MPAM	MPAMF_BASE_s	$0x2000 + (4 * n)$	MPAMCFG_MBW_PBM<n>_s

Accesses to this interface are RW.

MPAMCFG_MBW_PBM<n> can be accessed through its memory-mapped interface:

Component	Frame	Offset	Instance
MPAM	MPAMF_BASE_ns	$0x2000 + (4 * n)$	MPAMCFG_MBW_PBM<n>_ns

Accesses to this interface are RW.

MPAMCFG_MBW_PBM<n> can be accessed through its memory-mapped interface:

Component	Frame	Offset	Instance
MPAM	MPAMF_BASE_rt	$0x2000 + (4 * n)$	MPAMCFG_MBW_PBM<n>_rt

When FEAT_RME is implemented, accesses to this interface are RW.

MPAMCFG_MBW_PBM<n> can be accessed through its memory-mapped interface:

Component	Frame	Offset	Instance
MPAM	MPAMF_BASE_rl	$0x2000 + (4 * n)$	MPAMCFG_MBW_PBM<n>_rl

When FEAT_RME is implemented, accesses to this interface are RW.

11.4.12 MPAMCFG_MBW_PROP, MPAM Memory Bandwidth Proportional Stride Partition Configuration Register

The MPAMCFG_MBW_PROP characteristics are:

Purpose

Controls the proportional stride of memory bandwidth that the PARTID selected by [MPAMCFG_PART_SEL](#) uses.

MPAMCFG_MBW_PROP_s controls the bandwidth proportional stride for the Secure PARTID selected by the Secure instance of [MPAMCFG_PART_SEL](#). MPAMCFG_MBW_PROP_ns controls the bandwidth proportional stride for the Non-secure PARTID selected by the Non-secure instance of [MPAMCFG_PART_SEL](#). MPAMCFG_MBW_PROP_rt controls the bandwidth proportional stride for the Root PARTID selected by the Root instance of [MPAMCFG_PART_SEL](#). MPAMCFG_MBW_PROP_rl controls the bandwidth proportional stride for the Realm PARTID selected by the Realm instance of [MPAMCFG_PART_SEL](#).

Proportional stride is a relative cost of bandwidth requested by one PARTID in relation to the costs of the bandwidths requested by each other PARTID also competing to use the bandwidth.

If [MPAMF_IDR.HAS_RIS](#) is 1, the control settings accessed are those of the resource instance currently selected by [MPAMCFG_PART_SEL.RIS](#) and the PARTID selected by [MPAMCFG_PART_SEL.PARTID_SEL](#).

Configurations

The power domain of MPAMCFG_MBW_PROP is IMPLEMENTATION DEFINED.

This register is present only when FEAT_MPAM is implemented, [MPAMF_IDR.HAS_MBW_PART](#) == 1 and [MPAMF_MBW_IDR.HAS_PROP](#) == 1. Otherwise, direct accesses to MPAMCFG_MBW_PROP are RES0.

The power and reset domain of each MSC component is specific to that component.

Attributes

MPAMCFG_MBW_PROP is a 32-bit register.

Field descriptions



EN, bit [31]

Enable proportional stride bandwidth partitioning.

0b0 The selected partition is not regulated by proportional stride bandwidth partitioning.

0b1 The selected partition has bandwidth usage regulated by proportional stride bandwidth partitioning as controlled by STRIDEM1.

Bits [30:16]

Reserved, RES0.

STRIDEM1, bits [15:0]

Memory bandwidth stride minus 1 allocated to the partition selected by [MPAMCFG_PART_SEL](#). STRIDEM1 represents the normalized cost of bandwidth consumption by the partition.

The proportional stride partitioning control parameter is an unsigned integer representing the normalized cost to a partition for consuming bandwidth. Larger values have a larger cost and correspond to a lesser allocation of bandwidth while smaller values indicate a lesser cost and therefore a higher allocation of bandwidth.

The implemented width of STRIDEM1 is given in [MPAMF_MBW_IDR.BWA_WD](#).

Accessing the MPAMCFG_MBW_PROP:

This register is within the MPAM feature page memory frames.

In a system that supports Secure, Non-secure, Root, and Realm memory maps, there must be MPAM feature pages in all four address maps:

- MPAMCFG_MBW_PROP_s must be accessible from the Secure MPAM feature page.
- MPAMCFG_MBW_PROP_ns must be accessible from the Non-secure MPAM feature page.
- MPAMCFG_MBW_PROP_rt must be accessible from the Root MPAM feature page.
- MPAMCFG_MBW_PROP_rl must be accessible from the Realm MPAM feature page.

MPAMCFG_MBW_PROP_s, MPAMCFG_MBW_PROP_ns, MPAMCFG_MBW_PROP_rt, and MPAMCFG_MBW_PROP_rl must be separate registers:

- The Secure instance (MPAMCFG_MBW_PROP_s) accesses the memory proportional stride bandwidth partitioning used for Secure PARTIDs.
- The Non-secure instance (MPAMCFG_MBW_PROP_ns) accesses the memory proportional stride bandwidth partitioning used for Non-secure PARTIDs.
- The Root instance (MPAMCFG_MBW_PROP_rt) accesses the memory proportional stride bandwidth partitioning used for Root PARTIDs.
- The Realm instance (MPAMCFG_MBW_PROP_rl) accesses the memory proportional stride bandwidth partitioning used for Realm PARTIDs.

When RIS is implemented, loads and stores to MPAMCFG_MBW_PROP access the memory proportional stride bandwidth partitioning configuration settings for the bandwidth resource instance selected by MPAMCFG_PART_SEL.RIS and the PARTID selected by MPAMCFG_PART_SEL.PARTID_SEL.

When RIS is not implemented, loads and stores to MPAMCFG_MBW_PROP access the memory proportional stride bandwidth partitioning configuration settings for the PARTID selected by MPAMCFG_PART_SEL.PARTID_SEL.

When PARTID narrowing is implemented, loads and stores to MPAMCFG_MBW_PROP access the memory proportional stride bandwidth partitioning configuration settings for the internal PARTID selected by MPAMCFG_PART_SEL.PARTID_SEL, and MPAMCFG_PART_SEL.INTERNAL must be 1.

When PARTID narrowing is not implemented, loads and stores to MPAMCFG_MBW_PROP access the memory proportional stride bandwidth partitioning configuration settings for the request PARTID selected by MPAMCFG_PART_SEL.PARTID_SEL, and MPAMCFG_PART_SEL.INTERNAL must be 0.

MPAMCFG_MBW_PROP can be accessed through its memory-mapped interface:

Component	Frame	Offset	Instance
MPAM	MPAMF_BASE_s	0x0500	MPAMCFG_MBW_PROP_s

Accesses to this interface are RW.

MPAMCFG_MBW_PROP can be accessed through its memory-mapped interface:

Component	Frame	Offset	Instance
MPAM	MPAMF_BASE_ns	0x0500	MPAMCFG_MBW_PROP_ns

Accesses to this interface are RW.

MPAMCFG_MBW_PROP can be accessed through its memory-mapped interface:

Component	Frame	Offset	Instance
MPAM	MPAMF_BASE_rt	0x0500	MPAMCFG_MBW_PROP_rt

When FEAT_RME is implemented, accesses to this interface are RW.

MPAMCFG_MBW_PROP can be accessed through its memory-mapped interface:

Component	Frame	Offset	Instance
MPAM	MPAMF_BASE_rl	0x0500	MPAMCFG_MBW_PROP_rl

When FEAT_RME is implemented, accesses to this interface are RW.

11.4.13 MPAMCFG_MBW_WINWD, MPAM Memory Bandwidth Partitioning Window Width Configuration Register

The MPAMCFG_MBW_WINWD characteristics are:

Purpose

MPAMCFG_MBW_WINWD is a 32-bit register that shows and sets the value of the window width for the PARTID in [MPAMCFG_PART_SEL](#).

MPAMCFG_MBW_WINWD_s reads and controls the bandwidth control window width for the Secure PARTID selected by the Secure instance of [MPAMCFG_PART_SEL](#).

MPAMCFG_MBW_WINWD_ns reads and controls the bandwidth control window width for the Non-secure PARTID selected by the Non-secure instance of [MPAMCFG_PART_SEL](#).

MPAMCFG_MBW_WINWD_rt reads and controls the bandwidth control window width for the Root PARTID selected by the Root instance of [MPAMCFG_PART_SEL](#).

MPAMCFG_MBW_WINWD_rl reads and controls the bandwidth control window width for the Real PARTID selected by the Realm instance of [MPAMCFG_PART_SEL](#).

MPAMCFG_MBW_WINWD is read-only if [MPAMF_MBW_IDR](#).WINDWR == 0, and the window width is set by the hardware, even if variable.

MPAMCFG_MBW_WINWD is read/write if [MPAMF_MBW_IDR](#).WINDWR == 1, permitting configuration of the window width for each PARTID independently on hardware that supports this functionality.

If [MPAMF_IDR](#).HAS_RIS is 1, the control settings accessed are those of the resource instance currently selected by [MPAMCFG_PART_SEL](#).RIS and the PARTID selected by [MPAMCFG_PART_SEL](#).PARTID_SEL.

Configurations

The power domain of MPAMCFG_MBW_WINWD is IMPLEMENTATION DEFINED.

This register is present only when FEAT_MPAM is implemented and [MPAMF_IDR](#).HAS_MBW_PART == 1. Otherwise, direct accesses to MPAMCFG_MBW_WINWD are RES0.

The power and reset domain of each MSC component is specific to that component.

Attributes

MPAMCFG_MBW_WINWD is a 32-bit register.

Field descriptions

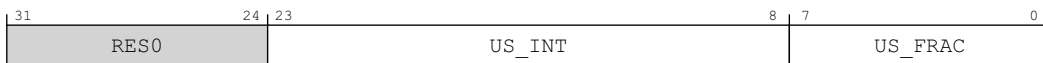

Bits [31:24]

Reserved, RES0.

US_INT, bits [23:8]

Window width, integer microseconds.

This field reads (and sets) the integer part of the window width in microseconds for the PARTID selected by [MPAMCFG_PART_SEL](#).

US_FRAC, bits [7:0]

Window width, fractional microseconds.

This field reads (and sets) the fractional part of the window width in microseconds for the PARTID selected by [MPAMCFG_PART_SEL](#).

Accessing the MPAMCFG_MBW_WINWD:

This register is within the MPAM feature page memory frames.

In a system that supports Secure, Non-secure, Root, and Realm memory maps, there must be MPAM feature pages in all four address maps:

- MPAMCFG_MBW_WINWD_s must be accessible from the Secure MPAM feature page.
- MPAMCFG_MBW_WINWD_ns must be accessible from the Non-secure MPAM feature page.
- MPAMCFG_MBW_WINWD_rt must be accessible from the Root MPAM feature page.
- MPAMCFG_MBW_WINWD_rl must be accessible from the Realm MPAM feature page.

MPAMCFG_MBW_WINWD_s, MPAMCFG_MBW_WINWD_ns, MPAMCFG_MBW_WINWD_rt, and MPAMCFG_MBW_WINWD_rl must be separate registers:

- The Secure instance (MPAMCFG_MBW_WINWD_s) accesses the window width used for Secure PARTIDs.
- The Non-secure instance (MPAMCFG_MBW_WINWD_ns) accesses the window width used for Non-secure PARTIDs.
- The Root instance (MPAMCFG_MBW_WINWD_rt) accesses the window width used for Root PARTIDs.
- The Realm instance (MPAMCFG_MBW_WINWD_rl) accesses the window width used for Realm PARTIDs.

When RIS is implemented, loads and stores to MPAMCFG_MBW_WINWD access the window width configuration settings for the bandwidth resource instance selected by MPAMCFG_PART_SEL.RIS and the PARTID selected by MPAMCFG_PART_SEL.PARTID_SEL.

When RIS is not implemented, loads and stores to MPAMCFG_MBW_WINWD access the window width configuration settings for the PARTID selected by MPAMCFG_PART_SEL.PARTID_SEL.

When PARTID narrowing is implemented, loads and stores to MPAMCFG_MBW_WINWD access the window width configuration settings for the internal PARTID selected by MPAMCFG_PART_SEL.PARTID_SEL, and MPAMCFG_PART_SEL.INTERNAL must be 1.

When PARTID narrowing is not implemented, loads and stores to MPAMCFG_MBW_WINWD access the window width configuration settings for the request PARTID selected by MPAMCFG_PART_SEL.PARTID_SEL, and MPAMCFG_PART_SEL.INTERNAL must be 0.

MPAMCFG_MBW_WINWD can be accessed through its memory-mapped interface:

Component	Frame	Offset	Instance
MPAM	MPAMF_BASE_s	0x0220	MPAMCFG_MBW_WINWD_s

This interface is accessible as follows:

- When MPAMF_MBW_IDR.WINDWR == 0 accesses to this register are RO.
- When MPAMF_MBW_IDR.WINDWR == 1 accesses to this register are RW.

MPAMCFG_MBW_WINWD can be accessed through its memory-mapped interface:

Component	Frame	Offset	Instance
MPAM	MPAMF_BASE_ns	0x0220	MPAMCFG_MBW_WINWD_ns

This interface is accessible as follows:

- When MPAMF_MBW_IDR.WINDWR == 0 accesses to this register are RO.
- When MPAMF_MBW_IDR.WINDWR == 1 accesses to this register are RW.

MPAMCFG_MBW_WINWD can be accessed through its memory-mapped interface:

Component	Frame	Offset	Instance
MPAM	MPAMF_BASE_rt	0x0220	MPAMCFG_MBW_WINWD_rt

This interface is accessible as follows:

- When FEAT_RME is implemented and MPAMF_MBW_IDR.WINDWR == 0 accesses to this register are RO.
- When FEAT_RME is implemented and MPAMF_MBW_IDR.WINDWR == 1 accesses to this register are RW.

MPAMCFG_MBW_WINWD can be accessed through its memory-mapped interface:

Component	Frame	Offset	Instance
MPAM	MPAMF_BASE_rl	0x0220	MPAMCFG_MBW_WINWD_rl

This interface is accessible as follows:

- When FEAT_RME is implemented and MPAMF_MBW_IDR.WINDWR == 0 accesses to this register are RO.
- When FEAT_RME is implemented and MPAMF_MBW_IDR.WINDWR == 1 accesses to this register are RW.

11.4.14 MPAMCFG_PART_SEL, MPAM Partition Configuration Selection Register

The MPAMCFG_PART_SEL characteristics are:

Purpose

Selects a partition ID to configure.

MPAMCFG_PART_SEL_s selects a Secure PARTID to configure. MPAMCFG_PART_SEL_ns selects a Non-secure PARTID to configure. MPAMCFG_PART_SEL_rt selects a Root PARTID to configure. MPAMCFG_PART_SEL_rl selects a Realm PARTID to configure.

After setting this register with a PARTID, software (usually a hypervisor) can perform a series of accesses to MPAMCFG registers to configure parameters for MPAM resource controls to use when requests have that PARTID.

Configurations

The power domain of MPAMCFG_PART_SEL is IMPLEMENTATION DEFINED.

This register is present only when FEAT_MPAM is implemented and (MPAMF_IDR.HAS_CCAP_PART == 1, or MPAMF_IDR.HAS_CPOR_PART == 1, or MPAMF_IDR.HAS_MBW_PART == 1, or MPAMF_IDR.HAS_PRI_PART == 1, or MPAMF_IDR.HAS_PARTID_NRW == 1, or (MPAMF_IDR.EXT == 0 and MPAMF_IDR.HAS_IMPL_IDR == 1) or (MPAMF_IDR.EXT == 1, MPAMF_IDR.HAS_IMPL_IDR == 1 and MPAMF_IDR.NO_IMPL_PART == 0)). Otherwise, direct accesses to MPAMCFG_PART_SEL are RES0.

The power and reset domain of each MSC component is specific to that component.

Attributes

MPAMCFG_PART_SEL is a 32-bit register.

Field descriptions

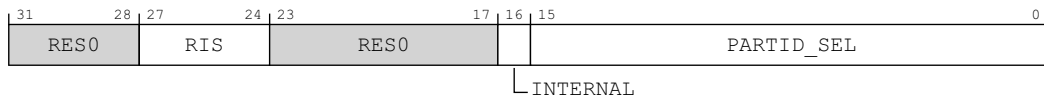

Bits [31:28]

Reserved, RES0.

RIS, bits [27:24]

When (FEAT_MPAMv0p1 is implemented or FEAT_MPAMv1p1 is implemented), MPAMF_IDR.EXT == 1 and MPAMF_IDR.HAS_RIS == 1:

Resource Instance Selector. RIS selects one resource to configure through MPAMCFG registers and describe with MPAMF ID registers.

Otherwise:

Reserved, RES0.

Bits [23:17]

Reserved, RES0.

INTERNAL, bit [16]

Internal PARTID.

If MPAMF_IDR.HAS_PARTID_NRW = 0, this field is RAZ/WI.

If MPAMF_IDR.HAS_PARTID_NRW = 1:

0b0 PARTID_SEL is interpreted as a request PARTID and ignored except for use with MPAMCFG_INTPARTID register access.

0b1 PARTID_SEL is interpreted as an internal PARTID and used for access to MPAMCFG control settings except for MPAMCFG_INTPARTID.

If PARTID narrowing is implemented as indicated by MPAMF_IDR.HAS_PARTID_NRW = 1, when accessing other MPAMCFG registers the value of the MPAMCFG_PART_SEL.INTERNAL bit is checked for these conditions:

- When the MPAMCFG_INTPARTID register is read or written, if the value of MPAMCFG_PART_SEL.INTERNAL is not 0, an Unexpected_INTERNAL error is set in MPAMF_ESR.
- When an MPAMCFG register other than MPAMCFG_INTPARTID is read or written, if the value of MPAMCFG_PART_SEL.INTERNAL is not 1, MPAMF_ESR is set to indicate an intPARTID_Range error.

In either error case listed here, the value returned by a read operation is UNPREDICTABLE, and the control settings are not affected by a write.

PARTID_SEL, bits [15:0]

Selects the partition ID to configure.

Reads and writes to other MPAMCFG registers are indexed by PARTID_SEL and by the NS bit used to access MPAMCFG_PART_SEL to access the configuration for a single partition.

Accessing the MPAMCFG_PART_SEL:

This register is within the MPAM feature page memory frames. In a system that supports Secure and Non-secure memory maps, there must be both Secure and Non-secure MPAM feature pages.

MPAMCFG_PART_SEL_s must be accessible from the Secure MPAM feature page. MPAMCFG_PART_SEL_ns must be accessible from the Non-secure MPAM feature page.

MPAMCFG_PART_SEL_s and MPAMCFG_PART_SEL_ns must be separate registers. The Secure instance (MPAMCFG_PART_SEL_s) accesses the PARTID selector used for Secure PARTIDs, and the Non-secure instance (MPAMCFG_PART_SEL_ns) accesses the PARTID selector used for Non-secure PARTIDs.

MPAMCFG_PART_SEL can be accessed through its memory-mapped interface:

Component	Frame	Offset	Instance
MPAM	MPAMF_BASE_s	0x0100	MPAMCFG_PART_SEL_s

Accesses to this interface are RW.

MPAMCFG_PART_SEL can be accessed through its memory-mapped interface:

Component	Frame	Offset	Instance
MPAM	MPAMF_BASE_ns	0x0100	MPAMCFG_PART_SEL_ns

Accesses to this interface are RW.

MPAMCFG_PART_SEL can be accessed through its memory-mapped interface:

Component	Frame	Offset	Instance
MPAM	MPAMF_BASE_rt	0x0100	MPAMCFG_PART_SEL_rt

When FEAT_RME is implemented, accesses to this interface are RW.

MPAMCFG_PART_SEL can be accessed through its memory-mapped interface:

Component	Frame	Offset	Instance
MPAM	MPAMF_BASE_r1	0x0100	MPAMCFG_PART_SEL_r1

When FEAT_RME is implemented, accesses to this interface are RW.

11.4.15 MPAMCFG_PRI, MPAM Priority Partition Configuration Register

The MPAMCFG_PRI characteristics are:

Purpose

Controls the internal and downstream priority of requests attributed to the PARTID selected by [MPAMCFG_PART_SEL](#).

MPAMCFG_PRI_s controls the priorities for the Secure PARTID selected by the Secure instance of [MPAMCFG_PART_SEL](#). MPAMCFG_PRI_ns controls the priorities for the Non-secure PARTID selected by the Non-secure instance of [MPAMCFG_PART_SEL](#). MPAMCFG_PRI_rt controls the priorities for the Root PARTID selected by the Root instance of [MPAMCFG_PART_SEL](#). MPAMCFG_PRI_rl controls the priorities for the Realm PARTID selected by the Realm instance of [MPAMCFG_PART_SEL](#).

If [MPAMF_IDR.HAS_RIS](#) is 1, the control settings accessed are those of the resource instance currently selected by [MPAMCFG_PART_SEL.RIS](#) and the PARTID selected by [MPAMCFG_PART_SEL.PARTID_SEL](#).

Configurations

The power domain of MPAMCFG_PRI is IMPLEMENTATION DEFINED.

This register is present only when FEAT_MPAM is implemented and [MPAMF_IDR.HAS_PRI_PART](#) == 1. Otherwise, direct accesses to MPAMCFG_PRI are RES0.

The power and reset domain of each MSC component is specific to that component.

Attributes

MPAMCFG_PRI is a 32-bit register.

Field descriptions

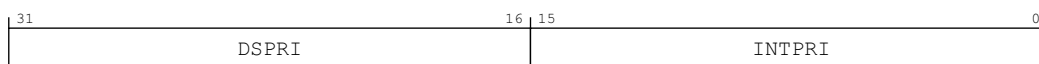

DSPRI, bits [31:16]

Downstream priority.

If [MPAMF_PRI_IDR.HAS_DSPRI](#) == 0, bits of this field are RES0 as this field is not used.

If [MPAMF_PRI_IDR.HAS_DSPRI](#) == 1, this field is a priority value applied to downstream communications from this MSC for transactions of the partition selected by [MPAMCFG_PART_SEL](#).

The implemented width of this field is [MPAMF_PRI_IDR.DSPRI_WD](#) bits. If the implemented width is less than the width of this field, the least significant bits are used.

The encoding of priority is 0-as-lowest or 0-as-highest priority according to the value of [MPAMF_PRI_IDR.DSPRI_0_IS_LOW](#).

INTPRI, bits [15:0]

Internal priority.

If [MPAMF_PRI_IDR.HAS_INTPRI](#) == 0, bits of this field are RES0 as this field is not used.

If [MPAMF_PRI_IDR.HAS_INTPRI](#) == 1, this field is a priority value applied internally inside this MSC for transactions of the partition selected by [MPAMCFG_PART_SEL](#).

The implemented width of this field is [MPAMF_PRI_IDR.INTPRI_WD](#) bits. If the implemented width is less than the width of this field, the least significant bits are used.

The encoding of priority is 0-as-lowest or 0-as-highest priority according to the value of [MPAMF_PRI_IDR.INTPRI_0_IS_LOW](#).

Accessing the MPAMCFG_PRI:

This register is within the MPAM feature page memory frames.

In a system that supports Secure, Non-secure, Root, and Realm memory maps, there must be MPAM feature pages in all four address maps:

- MPAMCFG_PRI_s must be accessible from the Secure MPAM feature page.
- MPAMCFG_PRI_ns must be accessible from the Non-secure MPAM feature page.
- MPAMCFG_PRI_rt must be accessible from the Root MPAM feature page.
- MPAMCFG_PRI_rl must be accessible from the Realm MPAM feature page.

MPAMCFG_PRI_s, MPAMCFG_PRI_ns, MPAMCFG_PRI_rt, and MPAMCFG_PRI_rl must be separate registers:

- The Secure instance (MPAMCFG_PRI_s) accesses the priority partitioning used for Secure PARTIDs.
- The Non-secure instance (MPAMCFG_PRI_ns) accesses the priority partitioning used for Non-secure PARTIDs.
- The Root instance (MPAMCFG_PRI_rt) accesses the priority partitioning used for Root PARTIDs.
- The Realm instance (MPAMCFG_PRI_rl) accesses the priority partitioning used for Realm PARTIDs.

When RIS is implemented, loads and stores to MPAMCFG_PRI access the priority partitioning configuration settings for the priority resource instance selected by MPAMCFG_PART_SEL.RIS and the PARTID selected by MPAMCFG_PART_SEL.PARTID_SEL.

When RIS is not implemented, loads and stores to MPAMCFG_PRI access the priority partitioning configuration settings for the PARTID selected by MPAMCFG_PART_SEL.PARTID_SEL.

When PARTID narrowing is implemented, loads and stores to MPAMCFG_PRI access the priority partitioning configuration settings for the internal PARTID selected by MPAMCFG_PART_SEL.PARTID_SEL, and MPAMCFG_PART_SEL.INTERNAL must be 1.

When PARTID narrowing is not implemented, loads and stores to MPAMCFG_PRI access the priority partitioning configuration settings for the request PARTID selected by MPAMCFG_PART_SEL.PARTID_SEL, and MPAMCFG_PART_SEL.INTERNAL must be 0.

MPAMCFG_PRI can be accessed through its memory-mapped interface:

Component	Frame	Offset	Instance
MPAM	MPAMF_BASE_s	0x0400	MPAMCFG_PRI_s

Accesses to this interface are RW.

MPAMCFG_PRI can be accessed through its memory-mapped interface:

Component	Frame	Offset	Instance
MPAM	MPAMF_BASE_ns	0x0400	MPAMCFG_PRI_ns

Accesses to this interface are RW.

MPAMCFG_PRI can be accessed through its memory-mapped interface:

Component	Frame	Offset	Instance
MPAM	MPAMF_BASE_rt	0x0400	MPAMCFG_PRI_rt

When FEAT_RME is implemented, accesses to this interface are RW.

MPAMCFG_PRI can be accessed through its memory-mapped interface:

Component	Frame	Offset	Instance
MPAM	MPAMF_BASE_rl	0x0400	MPAMCFG_PRI_rl

When FEAT_RME is implemented, accesses to this interface are RW.

11.5 Memory-mapped monitoring configuration registers

This section lists the external monitoring configuration registers.

11.5.1 MSMON_CAPT_EVNT, MPAM Capture Event Generation Register

The MSMON_CAPT_EVNT characteristics are:

Purpose

Generates a local capture event when written with bit[0] as 1.

MSMON_CAPT_EVNT_s generates local capture events for Secure monitor instances only or for Secure and Non-secure monitor instances. MSMON_CAPT_EVNT_ns generates local capture events for Non-secure monitor instances only. MSMON_CAPT_EVNT_rt generates local capture events for Root monitor instances only or for Root, Secure, Realm, and Non-secure monitor instances. MSMON_CAPT_EVNT_rl generates local capture events for Realm monitor instances or for for Realm monitor instances or Realm and Non-secure monitor instances.

Configurations

The power domain of MSMON_CAPT_EVNT is IMPLEMENTATION DEFINED.

This register is present only when FEAT_MPAM is implemented, MPAMF_IDR.HAS_MSMON == 1 and MPAMF_MSMON_IDR.HAS_LOCAL_CAPT_EVNT == 1. Otherwise, direct accesses to MSMON_CAPT_EVNT are RES0.

The power and reset domain of each MSC component is specific to that component.

Attributes

MSMON_CAPT_EVNT is a 32-bit register.

Field descriptions

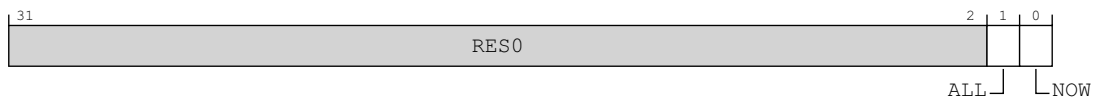

Bits [31:2]

Reserved, RES0.

ALL, bit [1]

In the Secure instance of this register:

- If ALL is written as 1 and NOW is also written as 1, signal a capture event to Secure and Non-secure monitor instances in this MSC that are configured with CAPT_EVNT = 7.
- If ALL is written as 0 and NOW is written as 1, signal a capture event to Secure monitor instances in this MSC that are configured with CAPT_EVNT = 7.

In the Non-secure instance of this register, this bit is RAZ/WI.

In the Root instance of this register:

- If ALL is written as 1 and NOW is also written as 1, signal a capture event to Root, Realm, Secure, and Non-secure monitor instances in this MSC that are configured with CAPT_EVNT = 7.
- If ALL is written as 0 and NOW is written as 1, signal a capture event to Root monitor instances within this MSC that are configured with CAPT_EVNT = 7.

In the Realm instance of this register:

- If ALL is written as 1 and NOW is also written as 1, signal a capture event to Realm and Non-secure monitor instances in this MSC that are configured with CAPT_EVNT = 7.
- If ALL is written as 0 and NOW is written as 1, signal a capture event to Realm monitor instances within this MSC that are configured with CAPT_EVNT = 7.

This bit always reads as zero.

- 0b0 Send capture event only to monitor instances in the same MPAM feature page as this register.
- 0b1 Send capture event to monitor instances in certain MPAM feature pages as described in the ALL field of this register.

NOW, bit [0]

When written as 1, this bit causes an event to those monitor instances described in the ALL field that have CAPT_EVNT set to the value of 7.

When this bit is written as 0, no event is signaled.

This bit always reads as zero.

Accessing the MSMON_CAPT_EVNT:

This register is within the MPAM feature page memory frames. In a system that supports Secure and Non-secure memory maps, there must be both Secure and Non-secure MPAM feature pages.

MSMON_CAPT_EVNT_s must be accessible from the Secure MPAM feature page. MSMON_CAPT_EVNT_ns must be accessible from the Non-secure MPAM feature page.

MSMON_CAPT_EVNT_s and MSMON_CAPT_EVNT_ns must be separate registers. The Secure instance (MSMON_CAPT_EVNT_s) can generate local capture events for Secure monitor instances only or for Secure and Non-secure monitor instances, and the Non-secure instance (MSMON_CAPT_EVNT_ns) can generate local capture events for Non-secure monitor instances only.

MSMON_CAPT_EVNT can be accessed through its memory-mapped interface:

Component	Frame	Offset	Instance
MPAM	MPAMF_BASE_s	0x0808	MSMON_CAPT_EVNT_s

Accesses to this interface are RW.

MSMON_CAPT_EVNT can be accessed through its memory-mapped interface:

Component	Frame	Offset	Instance
MPAM	MPAMF_BASE_ns	0x0808	MSMON_CAPT_EVNT_ns

Accesses to this interface are RW.

MSMON_CAPT_EVNT can be accessed through its memory-mapped interface:

Component	Frame	Offset	Instance
MPAM	MPAMF_BASE_rt	0x0808	MSMON_CAPT_EVNT_rt

When FEAT_RME is implemented, accesses to this interface are RW.

MSMON_CAPT_EVNT can be accessed through its memory-mapped interface:

Component	Frame	Offset	Instance
MPAM	MPAMF_BASE_rl	0x0808	MSMON_CAPT_EVNT_rl

When FEAT_RME is implemented, accesses to this interface are RW.

11.5.2 MSMON_CFG_CSU_CTL, MPAM Memory System Monitor Configure Cache Storage Usage Monitor Control Register

The MSMON_CFG_CSU_CTL characteristics are:

Purpose

Controls the CSU monitor selected by [MSMON_CFG_MON_SEL](#).

MSMON_CFG_CSU_CTL_s controls the Secure cache storage usage monitor instance selected by the Secure instance of [MSMON_CFG_MON_SEL](#). MSMON_CFG_CSU_CTL_ns controls Non-secure cache storage usage monitor instance selected by the Non-secure instance of [MSMON_CFG_MON_SEL](#). MSMON_CFG_CSU_CTL_rt controls the monitor configuration for the Root PARTID selected by the Root instance of [MSMON_CFG_MON_SEL](#). MSMON_CFG_CSU_CTL_rl controls the monitor configuration for the Realm PARTID selected by the Realm instance of [MSMON_CFG_MON_SEL](#).

If [MPAMF_IDR.HAS_RIS](#) is 1, the monitor instance configuration accessed is for the resource instance currently selected by [MSMON_CFG_MON_SEL.RIS](#) and the monitor instance of that resource instance selected by [MSMON_CFG_MON_SEL.MON_SEL](#).

Configurations

The power domain of MSMON_CFG_CSU_CTL is IMPLEMENTATION DEFINED.

This register is present only when FEAT_MPAM is implemented, [MPAMF_IDR.HAS_MSMON](#) == 1 and [MPAMF_MSMON_IDR.MSMON_CSU](#) == 1. Otherwise, direct accesses to MSMON_CFG_CSU_CTL are RES0.

The power and reset domain of each MSC component is specific to that component.

Attributes

MSMON_CFG_CSU_CTL is a 32-bit register.

Field descriptions

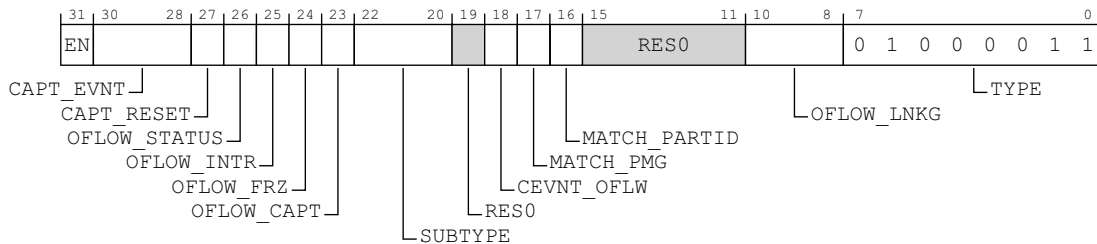

EN, bit [31]

Enabled.

0b0 The monitor instance is disabled and must not collect any information.

0b1 The monitor instance is enabled to collect information according to the configuration of the instance.

CAPT_EVNT, bits [30:28]

Capture event selector.

Select the event that triggers capture from the following:

0b000 No capture event is triggered.

0b001 External capture event 1 (optional, but recommended)

0b010 External capture event 2 (optional)

0b011 External capture event 3 (optional)

- 0b100 External capture event 4 (optional)
- 0b101 External capture event 5 (optional)
- 0b110 External capture event 6 (optional)
- 0b111 Capture occurs when a `MSMON_CAPT_EVNT` register in this MSC is written and causes a capture event for the Security state of this monitor. (optional)

The values marked as optional indicate capture event sources that can be omitted in an implementation. Those values representing non-implemented event sources must not trigger a capture event.

If capture is not implemented for the CSU monitor type as indicated by `MPAMF_CSUMON_IDR.HAS_CAPTURE = 0`, this field is RAZ/WI.

CAPT_RESET, bit [27]

Reset after capture.

Controls whether the value of `MSMON_CSU` is reset to zero immediately after being copied to `MSMON_CSU_CAPTURE`.

- 0b0 Monitor is not reset on capture.
- 0b1 Monitor is reset on capture.

If capture is not implemented for the CSU monitor type as indicated by `MPAMF_CSUMON_IDR.HAS_CAPTURE = 0`, this field is RAZ/WI.

Because the CSU monitor type produces a measurement rather than a count, it might not make sense to ever reset the value after a capture. If there is no reason to ever reset a CSU monitor, this field is RAZ/WI.

OFLOW_STATUS, bit [26]

Overflow status.

Indicates whether the value of `MSMON_CSU` has overflowed.

If `MPAMF_CSUMON_IDR.HAS_CEVRT_OFLW` is 1 or `MPAMF_CSUMON_IDR.HAS_OFLOW_LNKG` is 1, then a store to `MSMON_CSU` when this field is 1 resets this field to 0.

- 0b0 No overflow has occurred.
- 0b1 At least one overflow has occurred since this bit was last written to zero.

If overflow is not possible for a CSU monitor in the implementation, this field is RAZ/WI.

OFLOW_INTR, bit [25]

Overflow Interrupt.

Controls whether an overflow interrupt is generated when the value of `MSMON_CSU` has overflowed.

- 0b0 No interrupt is signaled on an overflow of `MSMON_CSU`.
- 0b1 On overflow, an implementation-specific interrupt is signaled.

If `OFLOW_INTR` is not supported by the implementation, this field is RAZ/WI.

OFLOW_FRZ, bit [24]

Freeze Monitor on Overflow.

Controls whether the value of `MSMON_CSU.VALUE` freezes on an overflow.

- 0b0 Monitor count wraps on overflow.
- 0b1 Monitor count freezes on overflow. The frozen value might be 0 or another value if the monitor overflowed with an increment larger than 1.

If overflow is not possible for a CSU monitor in the implementation, this field is RAZ/WI.

When a `MSMON_CSU.VALUE` of a monitor instance is frozen it does not change until `MSMON_CSU` register for that instance has been written.

OFLOW_CAPT, bit [23]

When (FEAT_MPAMv0p1 is implemented or FEAT_MPAMv1p1 is implemented) and MPAMF_CSUMON_IDR.HAS_CEVNT_OFLW == 1:

Capture Monitor on Overflow.

- 0b0 Monitor is not captured on an overflow or when affected by an overflow linkage event.
- 0b1 Monitor is captured and the `MSMON_CSU`.{NRDY, VALUE} fields are copied to the monitor instance's capture register on an overflow or when affected by an overflow linkage event. The monitor instance treats an overflow of this monitor instance as a private capture event. If `MSMON_CFG_MBWU_CTL.CEVNT_OFLW` is 1, this monitor instance also treats an overflow linkage event as a capture event.
- If the `OFLOW_FRZ` field is 1, the monitor does not continue to count after the overflow or overflow linkage event. If the `CAPT_RESET` field is 1, the monitor instance resets to 0.

Otherwise:

Reserved, RES0.

SUBTYPE, bits [22:20]

Subtype. Type of cache storage usage counted by this monitor.

This field is not currently used for CSU monitors, but reserved for future use.

This field is RAZ/WI.

Bit [19]

Reserved, RES0.

CEVNT_OFLW, bit [18]

When (FEAT_MPAMv0p1 is implemented or FEAT_MPAMv1p1 is implemented) and MPAMF_CSUMON_IDR.HAS_OFLOW_LNKG == 1:

Capture Event performs overflow behavior.

- 0b0 On a capture event matching the `CAPT_EVNT` field, the capture behaviors are performed.
- The `MSMON_CSU`.{VALUE, NRDY} fields are transferred to the monitor instance's capture register.
- 0b1 On a capture event matching the `CAPT_EVNT` field, the monitor instance treats a capture event as an overflow and the overflow behaviors are performed.
- The behavior is controlled by the `MSMON_CFG_CSU_CTL`.{OFLOW_FRZ, OFLOW_CAPT, CAPT_RESET} fields. The `MSMON_CFG_CSU_CTL.OFLOW_STATUS` field is set for this monitor instance.

Otherwise:

Reserved, RES0.

MATCH_PMG, bit [17]

Match PMG.

Controls whether the monitor measures only storage used with PMG matching `MSMON_CFG_CSU_FLT.PMG`.

- 0b0 The monitor measures storage used with any PMG value.
- 0b1 The monitor only measures storage used with the PMG value matching `MSMON_CFG_CSU_FLT.PMG`.

If `MATCH_PMG` is 1 and `MATCH_PARTID` is 0, it is CONSTRAINED UNPREDICTABLE whether the monitor instance:

- Measures the storage used with matching PMG and with any PARTID.
- Measures no storage usage, that is, `MSMON_CSU.VALUE` is zero.

- Measures the storage used with matching PMG and PARTID, that is, treats MATCH_PARTID as == 1.

MATCH_PARTID, bit [16]

Match PARTID.

Controls whether the monitor measures only storage used with PARTID matching `MSMON_CFG_CSU_FLT.PARTID`.

- 0b0 The monitor measures storage used with any PARTID value.
- 0b1 The monitor only measures storage used with the PARTID value matching `MSMON_CFG_CSU_FLT.PARTID`.

Bits [15:11]

Reserved, RES0.

OFLOW_LNKG, bits [10:8]

When (FEAT_MPAMv0p1 is implemented or FEAT_MPAMv1p1 is implemented) and MPAMF_CSUMON_IDR.HAS_OFLOW_LNKG == 1:

Overflow linkage event.

Controls signaling of a capture event on overflow of this monitor instance.

- 0b000 Overflow of the monitor instance only affects this monitor instance.
- 0b001 Overflow of this monitor instance signals Capture Event 1.
- 0b010 Overflow of this monitor instance signals Capture Event 2.
- 0b011 Overflow of this monitor instance signals Capture Event 3.
- 0b100 Overflow of this monitor instance signals Capture Event 4.
- 0b101 Overflow of this monitor instance signals Capture Event 5.
- 0b110 Overflow of this monitor instance signals Capture Event 6.
- 0b111 Reserved.

Otherwise:

Reserved, RES0.

TYPE, bits [7:0]

Monitor Type Code. The CSU monitor is TYPE = 0x43.

TYPE is a read-only constant indicating the type of the monitor.

Reads as 0x43.

Access to this field is RO.

Accessing the MSMON_CFG_CSU_CTL:

This register is within the MPAM feature page memory frames.

In a system that supports Secure, Non-secure, Root, and Realm memory maps, there must be MPAM feature pages in all four address maps:

- `MSMON_CFG_CSU_CTL_s` must be accessible from the Secure MPAM feature page.
- `MSMON_CFG_CSU_CTL_ns` must be accessible from the Non-secure MPAM feature page.
- `MSMON_CFG_CSU_CTL_rt` must be accessible from the Root MPAM feature page.
- `MSMON_CFG_CSU_CTL_rl` must be accessible from the Realm MPAM feature page.

MSMON_CFG_CSU_CTL_s, MSMON_CFG_CSU_CTL_ns, MSMON_CFG_CSU_CTL_rt, and MSMON_CFG_CSU_CTL_rl must be separate registers:

- The Secure instance (MSMON_CFG_CSU_CTL_s) accesses the cache storage usage monitor controls used for Secure PARTIDs.
- The Non-secure instance (MSMON_CFG_CSU_CTL_ns) accesses the cache storage usage monitor controls used for Non-secure PARTIDs.
- The Root instance (MSMON_CFG_CSU_CTL_rt) accesses the cache storage usage monitor controls used for Root PARTIDs.
- The Realm instance (MSMON_CFG_CSU_CTL_rl) accesses the cache storage usage monitor controls used for Realm PARTIDs.

When RIS is implemented, loads and stores to MSMON_CFG_CSU_CTL access the cache storage usage monitor configuration settings for the cache resource instance selected by [MSMON_CFG_MON_SEL.RIS](#) and the cache storage usage monitor instance selected by [MSMON_CFG_MON_SEL.MON_SEL](#).

When RIS is not implemented, loads and stores to MSMON_CFG_CSU_CTL access the cache storage usage monitor configuration settings for the cache storage usage monitor instance selected by [MSMON_CFG_MON_SEL.MON_SEL](#).

MSMON_CFG_CSU_CTL can be accessed through its memory-mapped interface:

Component	Frame	Offset	Instance
MPAM	MPAMF_BASE_s	0x0818	MSMON_CFG_CSU_CTL_s

Accesses to this interface are RW.

MSMON_CFG_CSU_CTL can be accessed through its memory-mapped interface:

Component	Frame	Offset	Instance
MPAM	MPAMF_BASE_ns	0x0818	MSMON_CFG_CSU_CTL_ns

Accesses to this interface are RW.

MSMON_CFG_CSU_CTL can be accessed through its memory-mapped interface:

Component	Frame	Offset	Instance
MPAM	MPAMF_BASE_rt	0x0818	MSMON_CFG_CSU_CTL_rt

When FEAT_RME is implemented, accesses to this interface are RW.

MSMON_CFG_CSU_CTL can be accessed through its memory-mapped interface:

Component	Frame	Offset	Instance
MPAM	MPAMF_BASE_rl	0x0818	MSMON_CFG_CSU_CTL_rl

When FEAT_RME is implemented, accesses to this interface are RW.

11.5.3 MSMON_CFG_CSU_FLT, MPAM Memory System Monitor Configure Cache Storage Usage Monitor Filter Register

The MSMON_CFG_CSU_FLT characteristics are:

Purpose

Configures PARTID and PMG to measure or count in the CSU monitor selected by [MSMON_CFG_MON_SEL](#).

MSMON_CFG_CSU_FLT_s sets filter conditions for the Secure cache storage usage monitor instance selected by the Secure instance of [MSMON_CFG_MON_SEL](#).

MSMON_CFG_CSU_CTL_ns sets filter conditions for the Non-secure cache storage usage monitor instance selected by the Non-secure instance of [MSMON_CFG_MON_SEL](#).

MSMON_CFG_CSU_FLT_rt sets the filter conditions for the Root PARTID selected by the Root instance of [MSMON_CFG_MON_SEL](#). MSMON_CFG_CSU_FLT_rl sets the filter conditions for the Realm PARTID selected by the Realm instance of [MSMON_CFG_MON_SEL](#).

If [MPAMF_IDR.HAS_RIS](#) is 1, the monitor instance filter configuration accessed is for the resource instance currently selected by [MSMON_CFG_MON_SEL.RIS](#) and the monitor instance of that resource instance selected by [MSMON_CFG_MON_SEL.MON_SEL](#).

Configurations

The power domain of MSMON_CFG_CSU_FLT is IMPLEMENTATION DEFINED.

This register is present only when FEAT_MPAM is implemented, MPAMF_IDR.HAS_MSMON == 1 and MPAMF_MSMON_IDR.MSMON_CSU == 1. Otherwise, direct accesses to MSMON_CFG_CSU_FLT are RES0.

The power and reset domain of each MSC component is specific to that component.

Attributes

MSMON_CFG_CSU_FLT is a 32-bit register.

Field descriptions

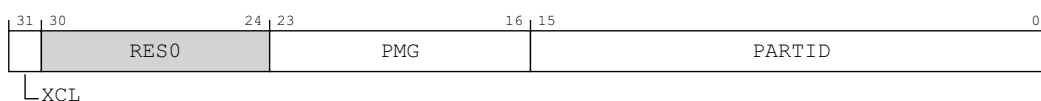

XCL, bit [31]

When (FEAT_MPAMv0p1 is implemented or FEAT_MPAMv1p1 is implemented) and MPAMF_CSUMON_IDR.HAS_XCL == 1:

Exclude Clean. The monitor instance does not count cache storage used by lines in an unmodified cache state.

0b0 Monitor instance counts cache storage in modified and unmodified cache lines.

0b1 Monitor instance counts cache storage in modified cache lines only.

Otherwise:

Reserved, RES0.

Bits [30:24]

Reserved, RES0.

PMG, bits [23:16]

Performance monitoring group to filter cache storage usage monitoring.

If [MSMON_CFG_CSU_CTL.MATCH_PMG](#) is 0, this field is not used to match cache storage to a PMG and the contents of this field is ignored.

If `MSMON_CFG_CSU_CTL.MATCH_PMG` is 1 and `MSMON_CFG_CSU_CTL.MATCH_PARTID` is 1, the monitor instance selected by `MSMON_CFG_MON_SEL` measures or counts cache storage labeled with PMG equal to this field and PARTID equal to the PARTID field.

If `MSMON_CFG_CSU_CTL.MATCH_PMG` is 1 and `MSMON_CFG_CSU_CTL.MATCH_PARTID` is 0, the behavior of the monitor instance selected by `MSMON_CFG_MON_SEL` is CONSTRAINED UNPREDICTABLE. See `MSMON_CFG_CSU_CTL.MATCH_PMG` for more information.

PARTID, bits [15:0]

Partition ID to filter cache storage usage monitoring.

If `MSMON_CFG_CSU_CTL.MATCH_PARTID` is 0 and `MSMON_CFG_CSU_CTL.MATCH_PMG` is 0, the monitor measures all allocated cache storage.

If `MSMON_CFG_CSU_CTL.MATCH_PARTID` is 0 and `MSMON_CFG_CSU_CTL.MATCH_PMG` is 1, the behavior of the monitor is CONSTRAINED UNPREDICTABLE. See the description of `MSMON_CFG_CSU_CTL.MATCH_PMG`.

If `MSMON_CFG_CSU_CTL.MATCH_PARTID` is 1 and `MSMON_CFG_CSU_CTL.MATCH_PMG` is 0, the monitor selected by `MSMON_CFG_MON_SEL` measures or counts cache storage labeled with PARTID equal to this field.

If `MSMON_CFG_CSU_CTL.MATCH_PARTID` is 1 and `MSMON_CFG_CSU_CTL.MATCH_PMG` is 1, the monitor selected by `MSMON_CFG_MON_SEL` measures or counts cache storage labeled with PARTID equal to this field and PMG equal to the PMG field.

Accessing the MSMON_CFG_CSU_FLT:

This register is within the MPAM feature page memory frames.

In a system that supports Secure, Non-secure, Root, and Realm memory maps, there must be MPAM feature pages in all four address maps:

- `MSMON_CFG_CSU_FLT_s` must be accessible from the Secure MPAM feature page.
- `MSMON_CFG_CSU_FLT_ns` must be accessible from the Non-secure MPAM feature page.
- `MSMON_CFG_CSU_FLT_rt` must be accessible from the Root MPAM feature page.
- `MSMON_CFG_CSU_FLT_rl` must be accessible from the Realm MPAM feature page.

`MSMON_CFG_CSU_FLT_s`, `MSMON_CFG_CSU_FLT_ns`, `MSMON_CFG_CSU_FLT_rt`, and `MSMON_CFG_CSU_FLT_rl` must be separate registers:

- The Secure instance (`MSMON_CFG_CSU_FLT_s`) accesses the PARTID and PMG matching for a cache storage usage monitor used for Secure PARTIDs.
- The Non-secure instance (`MSMON_CFG_CSU_FLT_ns`) accesses the PARTID and PMG matching for a cache storage usage monitor used for Non-secure PARTIDs.
- The Root instance (`MSMON_CFG_CSU_FLT_rt`) accesses the PARTID and PMG matching for a cache storage usage monitor used for Root PARTIDs.
- The Realm instance (`MSMON_CFG_CSU_FLT_rl`) accesses the PARTID and PMG matching for a cache storage usage monitor used for Realm PARTIDs.

When RIS is implemented, loads and stores to `MSMON_CFG_CSU_FLT` access the monitor configuration settings for the resource instance selected by `MSMON_CFG_MON_SEL.RIS` and the cache storage usage monitor instance selected by `MSMON_CFG_MON_SEL.MON_SEL`.

When RIS is not implemented, loads and stores to `MSMON_CFG_CSU_FLT` access the monitor configuration settings for the cache storage usage monitor instance selected by `MSMON_CFG_MON_SEL.MON_SEL`.

MSMON_CFG_CSU_FLT can be accessed through its memory-mapped interface:

Component	Frame	Offset	Instance
MPAM	MPAMF_BASE_s	0x0810	MSMON_CFG_CSU_FLT_s

Accesses to this interface are RW.

MSMON_CFG_CSU_FLT can be accessed through its memory-mapped interface:

Component	Frame	Offset	Instance
MPAM	MPAMF_BASE_ns	0x0810	MSMON_CFG_CSU_FLT_ns

Accesses to this interface are RW.

MSMON_CFG_CSU_FLT can be accessed through its memory-mapped interface:

Component	Frame	Offset	Instance
MPAM	MPAMF_BASE_rt	0x0810	MSMON_CFG_CSU_FLT_rt

When FEAT_RME is implemented, accesses to this interface are RW.

MSMON_CFG_CSU_FLT can be accessed through its memory-mapped interface:

Component	Frame	Offset	Instance
MPAM	MPAMF_BASE_rl	0x0810	MSMON_CFG_CSU_FLT_rl

When FEAT_RME is implemented, accesses to this interface are RW.

11.5.4 MSMON_CFG_MBWU_CTL, MPAM Memory System Monitor Configure Memory Bandwidth Usage Monitor Control Register

The MSMON_CFG_MBWU_CTL characteristics are:

Purpose

Controls the MBWU monitor selected by [MSMON_CFG_MON_SEL](#).

MSMON_CFG_MBWU_CTL_s controls the Secure memory bandwidth usage monitor instance selected by the Secure instance of [MSMON_CFG_MON_SEL](#). MSMON_CFG_MBWU_CTL_ns controls Non-secure memory bandwidth usage monitor instance selected by the Non-secure instance of [MSMON_CFG_MON_SEL](#). MSMON_CFG_MBWU_CTL_rt controls the monitor configuration for the Root PARTID selected by the Root instance of [MSMON_CFG_MON_SEL](#). MSMON_CFG_MBWU_CTL_rl controls the monitor configuration for the Realm PARTID selected by the Realm instance of [MSMON_CFG_MON_SEL](#).

If [MPAMF_IDR.HAS_RIS](#) is 1, the monitor instance configuration accessed is for the resource instance currently selected by [MSMON_CFG_MON_SEL.RIS](#) and the monitor instance of that resource instance selected by [MSMON_CFG_MON_SEL.MON_SEL](#).

Configurations

The power domain of MSMON_CFG_MBWU_CTL is IMPLEMENTATION DEFINED.

This register is present only when FEAT_MPAM is implemented, [MPAMF_IDR.HAS_MSMON](#) == 1 and [MPAMF_MSMON_IDR.MSMON_MBWU](#) == 1. Otherwise, direct accesses to MSMON_CFG_MBWU_CTL are RES0.

The power and reset domain of each MSC component is specific to that component.

Attributes

MSMON_CFG_MBWU_CTL is a 32-bit register.

Field descriptions

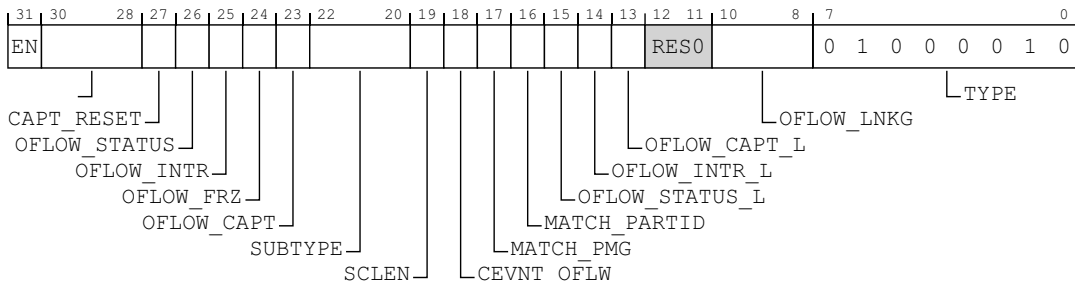

EN, bit [31]

Enabled.

0b0 The monitor instance is disabled and must not collect any information.

0b1 The monitor instance is enabled to collect information according to the configuration of the instance.

CAPT_EVNT, bits [30:28]

Capture event selector.

When the selected capture event occurs, [MSMON_MBWU](#) of the monitor instance is copied to [MSMON_MBWU_CAPTURE](#) of the same instance. If the long counter is also implemented, [MSMON_MBWU_L](#) is also copied to [MSMON_MBWU_L_CAPTURE](#).

Select the event that triggers capture from the following:

0b000 No capture event is triggered.

0b001	External capture event 1 (optional, but recommended)
0b010	External capture event 2 (optional)
0b011	External capture event 3 (optional)
0b100	External capture event 4 (optional)
0b101	External capture event 5 (optional)
0b110	External capture event 6 (optional)
0b111	Capture occurs when a <code>MSMON_CAPT_EVNT</code> register in this MSC is written and causes a capture event for the Security state of this monitor. (optional)

The values marked as optional indicate capture event sources that can be omitted in an implementation. Those values representing non-implemented event sources must not trigger a capture event.

If capture is not implemented for the MBWU monitor type as indicated by `MPAMF_MBWUMON_IDR.HAS_CAPTURE = 0`, this field is RAZ/WI.

CAPT_RESET, bit [27]

Reset `MSMON_MBWU.VALUE` after capture.

Controls whether the VALUE field of the monitor instance is reset to zero immediately after being copied to the corresponding capture register.

0b0	<code>MSMON_MBWU.VALUE</code> field of the monitor instance is not reset on capture.
0b1	<code>MSMON_MBWU.VALUE</code> field of the monitor instance is reset on capture.

If capture is not implemented for the MBWU monitor type as indicated by `MPAMF_MBWUMON_IDR.HAS_CAPTURE = 0`, this field is RAZ/WI.

This control bit affects both `MSMON_MBWU` and `MSMON_MBWU_L` in implementations that include `MSMON_MBWU_L`.

OFLOW_STATUS, bit [26]

Overflow status.

Indicates whether the value of `MSMON_MBWU` has overflowed.

0b0	<code>MSMON_MBWU.VALUE</code> has not overflowed.
0b1	<code>MSMON_MBWU.VALUE</code> has overflowed at least once since this bit was last written to zero.

If overflow is not possible for an MBWU monitor in the MSC implementation, this field is RAZ/WI.

Overflow status for `MSMON_MBWU_L.VALUE` is reported in `MSMON_CFG_MBWU_CTL.OFLOW_STATUS_L`.

If `MPAMF_MBWUMON_IDR.HAS_CEVNT_OFLW` is 1 or `MPAMF_MBWUMON_IDR.HAS_OFLOW_LNKG` is 1, then a store to `MSMON_MBWU` when this field is 1 resets this field to 0.

OFLOW_INTR, bit [25]

Enable interrupt on overflow of `MSMON_MBWU.VALUE`.

0b0	No interrupt is signaled on an overflow of <code>MSMON_MBWU.VALUE</code> .
0b1	An implementation-specific interrupt is signaled on an overflow of <code>MSMON_MBWU.VALUE</code> .

If overflow is not possible for an MBWU monitor in the MSC implementation, this field is RAZ/WI.

If overflow interrupt is not supported by the MSC implementation, this field is RAZ/WI.

Interrupt enable for overflow of `MSMON_MBWU_L.VALUE` is controlled by `MSMON_CFG_MBWU_CTL.OFLOW_INTR_L`.

OFLOW_FRZ, bit [24]

Freeze monitor instance on overflow.

Controls whether `MSMON_MBWU.VALUE` field of the monitor instance freezes on an overflow.

- 0b0 `MSMON_MBWU.VALUE` field of the monitor instance wraps on overflow.
- 0b1 `MSMON_MBWU.VALUE` field of the monitor instance freezes on overflow. If the increment that caused the overflow was 1, the frozen value is the post-increment value of 0. If the increment that caused the overflow was larger than 1, the frozen value of the monitor might be 0 or a larger value less than the final increment.

If overflow is not possible for the instance of the MBWU monitor in the implementation, this field is RAZ/WI.

When a `MSMON_MBWU.VALUE` of a monitor instance is frozen it does not change until `MSMON_CSU` register for that instance has been written. If the monitor implements both `MSMON_MBWU` and `MSMON_MBWU_L` registers, both are frozen. A write to a frozen register unfreezes the count for just that register.

This control bit affects both `MSMON_MBWU` and `MSMON_MBWU_L` in implementations that include `MSMON_MBWU_L`.

OFLOW_CAPT, bit [23]

When (*FEAT_MPAMv0p1 is implemented or FEAT_MPAMv1p1 is implemented*) and *MPAMF_MBWUMON_IDR.HAS_CEVNT_OFLW == 1*:

Capture Monitor on Overflow.

- 0b0 Monitor register `MSMON_MBWU` is not captured on an overflow or when affected by an overflow linkage event.
- 0b1 Monitor register `MSMON_MBWU` is captured and the `MSMON_MBWU.{NRDY, VALUE}` fields are copied to the monitor instance's `MSMON_MBWU_CAPTURE` register on an overflow or when affected by an overflow linkage event. The monitor instance treats an overflow of this monitor instance as a private capture event. If `MSMON_CFG_MBWU_CTL.CEVNT_OFLW` is 1, this monitor instance also treats an overflow linkage event as a capture event.

If `OFLOW_FRZ` is 1, the monitor does not continue to count after the overflow or overflow linkage event. If `CAPT_RESET` is 1, the monitor instance resets to 0.

This bit does not control whether `MSMON_MBWU_L` is captured on an overflow or overflow linkage event. See `MSMON_CFG_MBWU_CTL.OFLOW_CAPT_L`.

Otherwise:

Reserved, RES0.

SUBTYPE, bits [22:20]

Subtype. Type of bandwidth counted by this monitor.

This field is not currently used for MBWU monitors, but reserved for future use.

This field is RAZ/WI.

SCLEN, bit [19]

`MSMON_MBWU.VALUE` Scaling Enable.

Enables scaling of `MSMON_MBWU.VALUE` by `MPAMF_MBWUMON_IDR.SCALE`.

- 0b0 `MSMON_MBWU.VALUE` has bytes counted by the monitor instance.
- 0b1 `MSMON_MBWU.VALUE` has bytes counted by the monitor instance, shifted right by `MPAMF_MBWUMON_IDR.SCALE`.

CEVNT_OFLW, bit [18]

When (*FEAT_MPAMv0p1 is implemented or FEAT_MPAMv1p1 is implemented*) and *MPAMF_MBWUMON_IDR.HAS_OFLOW_LNKG == 1*:

Capture Event performs overflow behavior.

- 0b0 On a capture event matching the `CAPT_EVNT` field the capture behaviors are performed.

The NRDY and VALUE fields are transferred to the monitor instance's capture register.

- 0b1 On a capture event matching the CAPT_EVNT field the monitor instance treats a capture event as an overflow and the overflow behaviors are performed.
 The behavior is controlled by the MSMON_CFG_MBWU_CTL.{OFLOW_FRZ, OFLOW_CAPT, OFLOW_CAPT_L, CAPT_RESET} fields. The MSMON_CFG_MBWU_CTL.{OFLOW_STATUS, OFLOW_STATUS_L} fields are set for this monitor instance.

Otherwise:

Reserved, RES0.

MATCH_PMG, bit [17]

Match PMG.

Controls whether the monitor instance only counts data transferred with PMG matching [MSMON_CFG_MBWU_FLT.PMG](#).

- 0b0 The monitor instance counts data transferred with any PMG value.
- 0b1 The monitor instance only counts data transferred with the PMG value matching [MSMON_CFG_MBWU_FLT.PMG](#).

MATCH_PARTID, bit [16]

Match PARTID.

Controls whether the monitor instance counts only data transferred with PARTID matching [MSMON_CFG_MBWU_FLT.PARTID](#).

- 0b0 The monitor instance counts data transferred with any PARTID value.
- 0b1 The monitor instance only counts data transferred with the PARTID value matching [MSMON_CFG_MBWU_FLT.PARTID](#).

OFLOW_STATUS_L, bit [15]

When FEAT_MPAMv0p1 is implemented or FEAT_MPAMv1p1 is implemented:

Overflow Status of [MSMON_MBWU_L.VALUE](#) of the monitor instance.

Indicates whether [MSMON_MBWU_L.VALUE](#) has overflowed.

- 0b0 [MSMON_MBWU_L.VALUE](#) has not overflowed.
- 0b1 [MSMON_MBWU_L.VALUE](#) has overflowed at least once since this bit was last written to zero.

If [MPAMF_MBWUMON_IDR.HAS_LONG](#) == 0, this bit is RES0.

Overflow status of [MSMON_MBWU.VALUE](#) is reported in [MSMON_CFG_MBWU_CTL.OFLOW_STATUS](#).

If [MPAMF_MBWUMON_IDR.HAS_CEVTNTOFLW](#) is 1 or [MPAMF_MBWUMON_IDR.HAS_OFLOW_LNKG](#) is 1, then a store to [MSMON_MBWU_L](#) when this field is 1 resets this field to 0.

Otherwise:

Reserved, RES0.

OFLOW_INTR_L, bit [14]

When (FEAT_MPAMv0p1 is implemented or FEAT_MPAMv1p1 is implemented) and MPAMF_MBWUMON_IDR.HAS_LONG == 1:

Overflow Interrupt for [MSMON_MBWU_L](#).

Controls whether an MPAM overflow interrupt is generated when [MSMON_MBWU_L.VALUE](#) overflows.

- 0b0 No interrupt is signaled on an overflow of [MSMON_MBWU_L.VALUE](#).
- 0b1 An implementation-specific interrupt is signaled on overflow of [MSMON_MBWU_L.VALUE](#).

If overflow is not possible for an MBWU monitor in the MSC implementation, this field is RAZ/WI.

If the overflow interrupt is not supported by the MSC implementation, this field is RAZ/WI.

Otherwise:

Reserved, RES0.

OFLOW_CAPT_L, bit [13]

**When (*FEAT_MPAMv0p1* is implemented or *FEAT_MPAMv1p1* is implemented),
MPAMF_MBWUMON_IDR.HAS_LONG == 1 and
MPAMF_MBWUMON_IDR.HAS_CEVNT_OFLW == 1:**

Capture Long Monitor on Overflow.

Controls whether *MSMON_MBWU_L* is copied to *MSMON_MBWU_L_CAPTURE* on an overflow or an overflow linkage event.

0b0 Monitor register *MSMON_MBWU_L* is not captured on an overflow or when affected by an overflow linkage event.

0b1 Monitor register *MSMON_MBWU_L* is captured on an overflow or when affected by an overflow linkage event. If *OFLOW_FRZ* is 1, the monitor does not continue to count after the overflow or overflow linkage event. If *CAPT_RESET* is 1, the monitor instance resets to 0.

If this bit is 1, this monitor instance treats an overflow of this monitor instance as a private capture event.

If this bit is 1, this monitor instance also treats overflow linkage events for which it qualifies as a private capture event.

Otherwise:

Reserved, RES0.

Bits [12:11]

Reserved, RES0.

OFLOW_LNKG, bits [10:8]

**When (*FEAT_MPAMv0p1* is implemented or *FEAT_MPAMv1p1* is implemented) and
MPAMF_CSUMON_IDR.HAS_OFLOW_LNKG == 1:**

Overflow linkage event.

Controls signaling of a capture event on overflow of this monitor instance.

0b000 Overflow of the monitor instance only affects this monitor instance.

0b001 Overflow of this monitor instance signals Capture Event 1.

0b010 Overflow of this monitor instance signals Capture Event 2.

0b011 Overflow of this monitor instance signals Capture Event 3.

0b100 Overflow of this monitor instance signals Capture Event 4.

0b101 Overflow of this monitor instance signals Capture Event 5.

0b110 Overflow of this monitor instance signals Capture Event 6.

0b111 Reserved.

Otherwise:

Reserved, RES0.

TYPE, bits [7:0]

Monitor Type Code. The MBWU monitor is *TYPE* = 0x42.

TYPE is a read-only constant indicating the type of the monitor.

Reads as 0x42.

Access to this field is RO.

Accessing the MSMON_CFG_MBWU_CTL:

This register is within the MPAM feature page memory frames.

In a system that supports Secure, Non-secure, Root, and Realm memory maps, there must be MPAM feature pages in all four address maps:

- MSMON_CFG_MBWU_CTL_s must be accessible from the Secure MPAM feature page.
- MSMON_CFG_MBWU_CTL_ns must be accessible from the Non-secure MPAM feature page.
- MSMON_CFG_MBWU_CTL_rt must be accessible from the Root MPAM feature page.
- MSMON_CFG_MBWU_CTL_rl must be accessible from the Realm MPAM feature page.

MSMON_CFG_MBWU_CTL_s, MSMON_CFG_MBWU_CTL_ns, MSMON_CFG_MBWU_CTL_rt, and MSMON_CFG_MBWU_CTL_rl must be separate registers:

- The Secure instance (MSMON_CFG_MBWU_CTL_s) accesses the memory bandwidth usage monitor controls used for Secure PARTIDs.
- The Non-secure instance (MSMON_CFG_MBWU_CTL_ns) accesses the memory bandwidth usage monitor controls used for Non-secure PARTIDs.
- The Root instance (MSMON_CFG_MBWU_CTL_rt) accesses the memory bandwidth usage monitor controls used for Root PARTIDs.
- The Realm instance (MSMON_CFG_MBWU_CTL_rl) accesses the memory bandwidth usage monitor controls used for Realm PARTIDs.

When RIS is implemented, loads and stores to MSMON_CFG_MBWU_CTL access the monitor configuration settings for the bandwidth resource instance selected by [MSMON_CFG_MON_SEL.RIS](#) and the memory bandwidth usage monitor instance selected by [MSMON_CFG_MON_SEL.MON_SEL](#).

When RIS is not implemented, loads and stores to MSMON_CFG_MBWU_CTL access the monitor configuration settings for the memory bandwidth usage monitor instance selected by [MSMON_CFG_MON_SEL.MON_SEL](#).

MSMON_CFG_MBWU_CTL can be accessed through its memory-mapped interface:

Component	Frame	Offset	Instance
MPAM	MPAMF_BASE_s	0x0828	MSMON_CFG_MBWU_CTL_s

Accesses to this interface are RW.

MSMON_CFG_MBWU_CTL can be accessed through its memory-mapped interface:

Component	Frame	Offset	Instance
MPAM	MPAMF_BASE_ns	0x0828	MSMON_CFG_MBWU_CTL_ns

Accesses to this interface are RW.

MSMON_CFG_MBWU_CTL can be accessed through its memory-mapped interface:

Component	Frame	Offset	Instance
MPAM	MPAMF_BASE_rt	0x0828	MSMON_CFG_MBWU_CTL_rt

When FEAT_RME is implemented, accesses to this interface are RW.

MSMON_CFG_MBWU_CTL can be accessed through its memory-mapped interface:

Component	Frame	Offset	Instance
MPAM	MPAMF_BASE_r1	0x0828	MSMON_CFG_MBWU_CTL_r1

When FEAT_RME is implemented, accesses to this interface are RW.

11.5.5 MSMON_CFG_MBWU_FLT, MPAM Memory System Monitor Configure Memory Bandwidth Usage Monitor Filter Register

The MSMON_CFG_MBWU_FLT characteristics are:

Purpose

Controls PARTID and PMG to measure or count in the MBWU monitor selected by [MSMON_CFG_MON_SEL](#).

MSMON_CFG_MBWU_FLT_s sets filter conditions for the Secure memory bandwidth usage monitor instance selected by the Secure instance of [MSMON_CFG_MON_SEL](#).

MSMON_CFG_MBWU_CTL_ns sets filter conditions for the Non-secure memory bandwidth usage monitor instance selected by the Non-secure instance of [MSMON_CFG_MON_SEL](#).

MSMON_CFG_CSU_FLT_rt sets the filter conditions for the Root PARTID selected by the Root instance of [MSMON_CFG_MON_SEL](#). MSMON_CFG_CSU_FLT_rl sets the filter conditions for the Realm PARTID selected by the Realm instance of [MSMON_CFG_MON_SEL](#).

If [MPAMF_IDR.HAS_RIS](#) is 1, the monitor instance filter configuration accessed is for the resource instance currently selected by [MSMON_CFG_MON_SEL.RIS](#) and the monitor instance of that resource instance selected by [MSMON_CFG_MON_SEL.MON_SEL](#).

Configurations

The power domain of MSMON_CFG_MBWU_FLT is IMPLEMENTATION DEFINED.

This register is present only when FEAT_MPAM is implemented, [MPAMF_IDR.HAS_MSMON](#) == 1 and [MPAMF_MSMON_IDR.MSMON_MBWU](#) == 1. Otherwise, direct accesses to MSMON_CFG_MBWU_FLT are RES0.

The power and reset domain of each MSC component is specific to that component.

Attributes

MSMON_CFG_MBWU_FLT is a 32-bit register.

Field descriptions

When FEAT_MPAMv0p1 is implemented or FEAT_MPAMv1p1 is implemented:

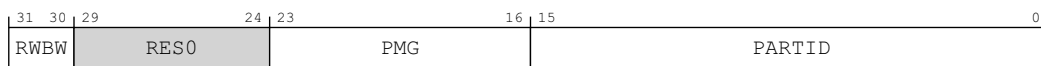

RW filtering.

RWBW, bits [31:30]

When [MPAMF_MBWUMON_IDR.HAS_RWBW](#) == 1:

Read/write bandwidth filter. Configures the selected monitor instance to count all bandwidth, only read bandwidth or only write bandwidth.

- 0b00 Monitor instance counts read bandwidth and write bandwidth.
- 0b01 Monitor instance counts write bandwidth only.
- 0b10 Monitor instance counts read bandwidth only.
- 0b11 Reserved.

Otherwise:

Reserved, RES0.

Bits [29:24]

Reserved, RES0.

PMG, bits [23:16]

Performance monitoring group to filter memory bandwidth usage monitoring.

If `MSMON_CFG_MBWU_CTL.MATCH_PMG == 0`, this field is not used to match memory bandwidth to a PMG and the contents of this field is ignored.

If `MSMON_CFG_MBWU_CTL.MATCH_PMG == 1`, the monitor selected by `MSMON_CFG_MON_SEL` measures or counts memory bandwidth labeled with PMG equal to this field.

PARTID, bits [15:0]

Partition ID to filter memory bandwidth usage monitoring.

If `MSMON_CFG_MBWU_CTL.MATCH_PARTID == 0`, this field is not used to match memory bandwidth to a PARTID and the contents of this field is ignored.

If `MSMON_CFG_MBWU_CTL.MATCH_PARTID == 1`, the monitor selected by `MSMON_CFG_MON_SEL` measures or counts memory bandwidth labeled with PARTID equal to this field.

Otherwise:

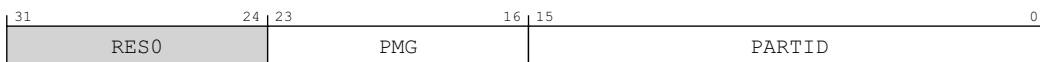

Bits [31:24]

Reserved, RES0.

PMG, bits [23:16]

Performance monitoring group to filter memory bandwidth usage monitoring.

If `MSMON_CFG_MBWU_CTL.MATCH_PMG == 0`, this field is not used to match memory bandwidth to a PMG and the contents of this field is ignored.

If `MSMON_CFG_MBWU_CTL.MATCH_PMG == 1`, the monitor selected by `MSMON_CFG_MON_SEL` measures or counts memory bandwidth labeled with PMG equal to this field.

PARTID, bits [15:0]

Partition ID to filter memory bandwidth usage monitoring.

If `MSMON_CFG_MBWU_CTL.MATCH_PARTID == 0`, this field is not used to match memory bandwidth to a PARTID and the contents of this field is ignored.

If `MSMON_CFG_MBWU_CTL.MATCH_PARTID == 1`, the monitor selected by `MSMON_CFG_MON_SEL` measures or counts memory bandwidth labeled with PARTID equal to this field.

Accessing the MSMON_CFG_MBWU_FLT:

This register is within the MPAM feature page memory frames.

In a system that supports Secure, Non-secure, Root, and Realm memory maps, there must be MPAM feature pages in all four address maps:

- `MSMON_CFG_MBWU_FLT_s` must be accessible from the Secure MPAM feature page.
- `MSMON_CFG_MBWU_FLT_ns` must be accessible from the Non-secure MPAM feature page.
- `MSMON_CFG_MBWU_FLT_rt` must be accessible from the Root MPAM feature page.
- `MSMON_CFG_MBWU_FLT_rl` must be accessible from the Realm MPAM feature page.

MSMON_CFG_MBWU_FLT_s, MSMON_CFG_MBWU_FLT_ns, MSMON_CFG_MBWU_FLT_rt, and MSMON_CFG_MBWU_FLT_rl must be separate registers:

- The Secure instance (MSMON_CFG_MBWU_FLT_s) accesses the PARTID and PMG matching for a memory bandwidth usage monitor used for Secure PARTIDs.
- The Non-secure instance (MSMON_CFG_MBWU_FLT_ns) accesses the PARTID and PMG matching for a memory bandwidth usage monitor used for Non-secure PARTIDs.
- The Root instance (MSMON_CFG_MBWU_FLT_rt) accesses the PARTID and PMG matching for a memory bandwidth usage monitor used for Root PARTIDs.
- The Realm instance (MSMON_CFG_MBWU_FLT_rl) accesses the PARTID and PMG matching for a memory bandwidth usage monitor used for Realm PARTIDs.

When RIS is implemented, loads and stores to MSMON_CFG_MBWU_FLT access the monitor configuration settings for the bandwidth resource instance selected by [MSMON_CFG_MON_SEL.RIS](#) and the memory bandwidth usage monitor instance selected by [MSMON_CFG_MON_SEL.MON_SEL](#).

When RIS is not implemented, loads and stores to MSMON_CFG_MBWU_FLT access the monitor configuration settings for the memory bandwidth usage monitor instance selected by [MSMON_CFG_MON_SEL.MON_SEL](#).

MSMON_CFG_MBWU_FLT can be accessed through its memory-mapped interface:

Component	Frame	Offset	Instance
MPAM	MPAMF_BASE_s	0x0820	MSMON_CFG_MBWU_FLT_s

Accesses to this interface are RW.

MSMON_CFG_MBWU_FLT can be accessed through its memory-mapped interface:

Component	Frame	Offset	Instance
MPAM	MPAMF_BASE_ns	0x0820	MSMON_CFG_MBWU_FLT_ns

Accesses to this interface are RW.

MSMON_CFG_MBWU_FLT can be accessed through its memory-mapped interface:

Component	Frame	Offset	Instance
MPAM	MPAMF_BASE_rt	0x0820	MSMON_CFG_MBWU_FLT_rt

When FEAT_RME is implemented, accesses to this interface are RW.

MSMON_CFG_MBWU_FLT can be accessed through its memory-mapped interface:

Component	Frame	Offset	Instance
MPAM	MPAMF_BASE_rl	0x0820	MSMON_CFG_MBWU_FLT_rl

When FEAT_RME is implemented, accesses to this interface are RW.

11.5.6 MSMON_CFG_MON_SEL, MPAM Monitor Instance Selection Register

The MSMON_CFG_MON_SEL characteristics are:

Purpose

Selects a monitor instance to access through the MSMON configuration and counter registers.

MSMON_CFG_MON_SEL_s selects a Secure monitor instance to access via the Secure MPAM feature page. MSMON_CFG_MON_SEL_ns selects a Non-secure monitor instance to access via the Non-secure MPAM feature page. MSMON_CFG_MON_SEL_rt selects a Root monitor instance to access via the Root MPAM feature page. MSMON_CFG_MON_SEL_rl selects a Realm monitor instance to access via the Realm MPAM feature page.

Note

Different performance monitoring features within an MSC could have different numbers of monitor instances. See the NUM_MON field in the corresponding ID register. This means that a monitor out-of-bounds error might be signaled when an MSMON_CFG register is accessed because the value in MSMON_CFG_MON_SEL.MON_SEL is too large for the particular monitoring feature.

To configure a monitor, set MON_SEL in this register to the index of the monitor instance to configure, then write to the MSMON_CFG_x register to set the configuration of the monitor. At a later time, read the monitor register (for example, MSMON_MBWU) to get the value of the monitor.

Configurations

The power domain of MSMON_CFG_MON_SEL is IMPLEMENTATION DEFINED.

This register is present only when FEAT_MPAM is implemented and (MPAMF_IDR.HAS_MSMON == 1, or (MPAMF_IDR.HAS_IMPL_IDR == 1 and MPAMF_IDR.EXT == 0) or (MPAMF_IDR.HAS_IMPL_IDR == 1, MPAMF_IDR.EXT == 1 and MPAMF_IDR.NO_IMPL_MSMON == 0)). Otherwise, direct accesses to MSMON_CFG_MON_SEL are RES0.

The power and reset domain of each MSC component is specific to that component.

Attributes

MSMON_CFG_MON_SEL is a 32-bit register.

Field descriptions



Bits [31:28]

Reserved, RES0.

RIS, bits [27:24]

When (FEAT_MPAMv0p1 is implemented or FEAT_MPAMv1p1 is implemented), MPAMF_IDR.EXT == 1 and MPAMF_IDR.HAS_RIS == 1:

Resource Instance Selector. RIS selects one resource to configure through MSMON_CFG registers.

Otherwise:

Reserved, RES0.

Bits [23:16]

Reserved, RES0.

MON_SEL, bits [15:0]

Selects the monitor instance to configure or read.

Reads and writes to other MSMON registers are indexed by MON_SEL and by the NS bit used to access MSMON_CFG_MON_SEL to access the configuration for a single monitor.

Accessing the MSMON_CFG_MON_SEL:

This register is within the MPAM feature page memory frames.

In a system that supports Secure, Non-secure, Root, and Realm memory maps, there must be MPAM feature pages in all four address maps:

- MSMON_CFG_MON_SEL_s must be accessible from the Secure MPAM feature page.
- MSMON_CFG_MON_SEL_ns must be accessible from the Non-secure MPAM feature page.
- MSMON_CFG_MON_SEL_rt must be accessible from the Root MPAM feature page.
- MSMON_CFG_MON_SEL_rl must be accessible from the Realm MPAM feature page.

MSMON_CFG_MON_SEL_s, MSMON_CFG_MON_SEL_ns, MSMON_CFG_MON_SEL_rt, and MSMON_CFG_MON_SEL_rl must be separate registers:

- The Secure instance (MSMON_CFG_MON_SEL_s) accesses the monitor instance selector used for Secure PARTIDs.
- The Non-secure instance (MSMON_CFG_MON_SEL_ns) accesses the monitor instance selector used for Non-secure PARTIDs.
- The Root instance (MSMON_CFG_MON_SEL_rt) accesses the monitor instance selector used for Root PARTIDs.
- The Realm instance (MSMON_CFG_MON_SEL_rl) accesses the monitor instance selector used for Realm PARTIDs.

MSMON_CFG_MON_SEL can be accessed through its memory-mapped interface:

Component	Frame	Offset	Instance
MPAM	MPAMF_BASE_s	0x0800	MSMON_CFG_MON_SEL_s

Accesses to this interface are RW.

MSMON_CFG_MON_SEL can be accessed through its memory-mapped interface:

Component	Frame	Offset	Instance
MPAM	MPAMF_BASE_ns	0x0800	MSMON_CFG_MON_SEL_ns

Accesses to this interface are RW.

MSMON_CFG_MON_SEL can be accessed through its memory-mapped interface:

Component	Frame	Offset	Instance
MPAM	MPAMF_BASE_rt	0x0800	MSMON_CFG_MON_SEL_rt

When FEAT_RME is implemented, accesses to this interface are RW.

MSMON_CFG_MON_SEL can be accessed through its memory-mapped interface:

Component	Frame	Offset	Instance
MPAM	MPAMF_BASE_r1	0x0800	MSMON_CFG_MON_SEL_r1

When FEAT_RME is implemented, accesses to this interface are RW.

11.5.7 MSMON_CSU, MPAM Cache Storage Usage Monitor Register

The MSMON_CSU characteristics are:

Purpose

Accesses the CSU monitor instance selected by [MSMON_CFG_MON_SEL](#).

MSMON_CSU_s is a Secure cache storage usage monitor instance selected by the Secure instance of [MSMON_CFG_MON_SEL](#). MSMON_CSU_ns is a Non-secure cache storage usage monitor instance selected by the Non-secure instance of [MSMON_CFG_MON_SEL](#). MSMON_CSU_rt is a Root cache storage usage monitor instance selected by the Root instance of [MSMON_CFG_MON_SEL](#). MSMON_CSU_rl is a Realm cache storage usage monitor instance selected by the Realm instance of [MSMON_CFG_MON_SEL](#).

If [MPAMF_IDR.HAS_RIS](#) is 1, the monitor instance accessed is for the resource instance currently selected by [MSMON_CFG_MON_SEL.RIS](#) and the monitor instance of that resource instance selected by [MSMON_CFG_MON_SEL.MON_SEL](#).

Configurations

The power domain of MSMON_CSU is IMPLEMENTATION DEFINED.

This register is present only when [FEAT_MPAM](#) is implemented, [MPAMF_IDR.HAS_MSMON](#) == 1 and [MPAMF_MSMON_IDR.MSMON_CSU](#) == 1. Otherwise, direct accesses to MSMON_CSU are RES0.

The power and reset domain of each MSC component is specific to that component.

Attributes

MSMON_CSU is a 32-bit register.

Field descriptions



NRDY, bit [31]

Not Ready. Indicates whether the monitor instance has possibly inaccurate data.

0b0 The monitor instance is ready and the MSMON_CSU.VALUE field is accurate.

0b1 The monitor instance is not ready and the contents of the MSMON_CSU.VALUE field might be inaccurate or otherwise not represent the actual cache storage usage.

VALUE, bits [30:0]

Cache storage usage measurement value if MSMON_CSU.NRDY is 0. Invalid if MSMON_CSU.NRDY is 1.

VALUE is the cache storage usage measured in bytes meeting the criteria set in [MSMON_CFG_CSU_FLT](#) and [MSMON_CFG_CSU_CTL](#) for the monitor instance selected by [MSMON_CFG_MON_SEL](#).

Accessing the MSMON_CSU:

This register is within the MPAM feature page memory frames.

In a system that supports Secure, Non-secure, Root, and Realm memory maps, there must be MPAM feature pages in all four address maps:

- MSMON_CSU_s must be accessible from the Secure MPAM feature page.
- MSMON_CSU_ns must be accessible from the Non-secure MPAM feature page.

- MSMON_CSU_rt must be accessible from the Root MPAM feature page.
- MSMON_CSU_rl must be accessible from the Realm MPAM feature page.

MSMON_CSU_s, MSMON_CSU_ns, MSMON_CSU_rt, and MSMON_CSU_rl must be separate registers:

- The Secure instance (MSMON_CSU_s) accesses the cache storage usage monitor used for Secure PARTIDs.
- The Non-secure instance (MSMON_CSU_ns) accesses the cache storage usage monitor used for Non-secure PARTIDs.
- The Root instance (MSMON_CSU_rt) accesses the cache storage usage monitor used for Root PARTIDs.
- The Realm instance (MSMON_CSU_rl) accesses the cache storage usage monitor used for Realm PARTIDs.

When RIS is implemented, reads and writes to MSMON_CSU access the cache storage usage monitor monitor instance for the cache resource instance selected by [MSMON_CFG_MON_SEL](#).RIS and the cache storage usage monitor instance selected by [MSMON_CFG_MON_SEL](#).MON_SEL.

When RIS is not implemented, reads and writes to MSMON_CSU access the cache storage usage monitor monitor instance for the cache storage usage monitor instance selected by [MSMON_CFG_MON_SEL](#).MON_SEL.

MSMON_CSU can be accessed through its memory-mapped interface:

Component	Frame	Offset	Instance
MPAM	MPAMF_BASE_s	0x0840	MSMON_CSU_s

This interface is accessible as follows:

- When MPAMF_CSUMON_IDR.CSU_RO == 0 accesses to this register are RW.
- When MPAMF_CSUMON_IDR.CSU_RO == 1 accesses to this register are RO.

MSMON_CSU can be accessed through its memory-mapped interface:

Component	Frame	Offset	Instance
MPAM	MPAMF_BASE_ns	0x0840	MSMON_CSU_ns

This interface is accessible as follows:

- When MPAMF_CSUMON_IDR.CSU_RO == 0 accesses to this register are RW.
- When MPAMF_CSUMON_IDR.CSU_RO == 1 accesses to this register are RO.

MSMON_CSU can be accessed through its memory-mapped interface:

Component	Frame	Offset	Instance
MPAM	MPAMF_BASE_rt	0x0840	MSMON_CSU_rt

This interface is accessible as follows:

- When FEAT_RME is implemented and MPAMF_CSUMON_IDR.CSU_RO == 0 accesses to this register are RW.
- When FEAT_RME is implemented and MPAMF_CSUMON_IDR.CSU_RO == 1 accesses to this register are RO.

MSMON_CSU can be accessed through its memory-mapped interface:

Component	Frame	Offset	Instance
MPAM	MPAMF_BASE_r1	0x0840	MSMON_CSU_r1

This interface is accessible as follows:

- When FEAT_RME is implemented and MPAMF_CSUMON_IDR.CSU_RO == 0 accesses to this register are RW.
- When FEAT_RME is implemented and MPAMF_CSUMON_IDR.CSU_RO == 1 accesses to this register are RO.

11.5.8 MSMON_CSU_CAPTURE, MPAM Cache Storage Usage Monitor Capture Register

The MSMON_CSU_CAPTURE characteristics are:

Purpose

MSMON_CSU_CAPTURE is a 32-bit read-write register that accesses the captured [MSMON_CSU](#) monitor instance selected by [MSMON_CFG_MON_SEL](#).

MSMON_CSU_CAPTURE_s is the Secure cache storage usage monitor capture instance selected by the Secure instance of [MSMON_CFG_MON_SEL](#). MSMON_CSU_CAPTURE_ns is the Non-secure cache storage usage monitor capture instance selected by the Non-secure instance of [MSMON_CFG_MON_SEL](#). MSMON_CSU_CAPTURE_rt is a Root cache storage usage monitor capture instance selected by the Root instance of [MSMON_CFG_MON_SEL](#).

MSMON_CSU_CAPTURE_rl is a Realm cache storage usage monitor capture instance selected by the Realm instance of [MSMON_CFG_MON_SEL](#).

If [MPAMF_IDR.HAS_RIS](#) is 1, the monitor instance capture register accessed is for the resource instance currently selected by [MSMON_CFG_MON_SEL.RIS](#) and the monitor instance of that resource instance selected by [MSMON_CFG_MON_SEL.MON_SEL](#).

Configurations

The power domain of MSMON_CSU_CAPTURE is IMPLEMENTATION DEFINED.

This register is present only when FEAT_MPAM is implemented, [MPAMF_IDR.HAS_MSMON](#) == 1, [MPAMF_MSMON_IDR.MSMON_CSU](#) == 1 and [MPAMF_CSUMON_IDR.HAS_CAPTURE](#) == 1. Otherwise, direct accesses to MSMON_CSU_CAPTURE are RES0.

The power and reset domain of each MSC component is specific to that component.

Attributes

MSMON_CSU_CAPTURE is a 32-bit register.

Field descriptions



NRDY, bit [31]

Not Ready. Indicates whether the captured monitor value has possibly inaccurate data.

0b0 The captured monitor instance was ready and the MSMON_CSU_CAPTURE.VALUE field is accurate.

0b1 The captured monitor instance was not ready and the contents of the MSMON_CSU_CAPTURE.VALUE field might be inaccurate or otherwise not represent the actual cache storage usage.

VALUE, bits [30:0]

Captured cache storage usage measurement if MSMON_CSU_CAPTURE.NRDY is 0. Invalid if MSMON_CSU_CAPTURE.NRDY is 1.

VALUE is the captured cache storage usage measurement in bytes meeting the criteria set in [MSMON_CFG_CSU_FLT](#) and [MSMON_CFG_CSU_CTL](#) for the monitor instance selected by [MSMON_CFG_MON_SEL](#).

Accessing the MSMON_CSU_CAPTURE:

This register is within the MPAM feature page memory frames.

In a system that supports Secure, Non-secure, Root, and Realm memory maps, there must be MPAM feature pages in all four address maps:

- MSMON_CSU_CAPTURE_s must be accessible from the Secure MPAM feature page.
- MSMON_CSU_CAPTURE_ns must be accessible from the Non-secure MPAM feature page.
- MSMON_CSU_CAPTURE_rt must be accessible from the Root MPAM feature page.
- MSMON_CSU_CAPTURE_rl must be accessible from the Realm MPAM feature page.

MSMON_CSU_CAPTURE_s, MSMON_CSU_CAPTURE_ns, MSMON_CSU_CAPTURE_rt, and MSMON_CSU_CAPTURE_rl must be separate registers:

- The Secure instance (MSMON_CSU_CAPTURE_s) accesses the captured cache storage usage monitor used for Secure PARTIDs.
- The Non-secure instance (MSMON_CSU_CAPTURE_ns) accesses the captured cache storage usage monitor used for Non-secure PARTIDs.
- The Root instance (MSMON_CSU_CAPTURE_rt) accesses the captured cache storage usage monitor used for Root PARTIDs.
- The Realm instance (MSMON_CSU_CAPTURE_rl) accesses the captured cache storage usage monitor used for Realm PARTIDs.

When RIS is implemented, reads and writes to MSMON_CSU_CAPTURE access the monitor instance for the cache resource instance selected by [MSMON_CFG_MON_SEL.RIS](#) and the cache storage usage monitor instance selected by [MSMON_CFG_MON_SEL.MON_SEL](#).

When RIS is not implemented, reads and writes to MSMON_CSU_CAPTURE access the monitor instance for the cache storage usage monitor instance selected by [MSMON_CFG_MON_SEL.MON_SEL](#).

MSMON_CSU_CAPTURE can be accessed through its memory-mapped interface:

Component	Frame	Offset	Instance
MPAM	MPAMF_BASE_s	0x0848	MSMON_CSU_CAPTURE_s

Accesses to this interface are RW.

MSMON_CSU_CAPTURE can be accessed through its memory-mapped interface:

Component	Frame	Offset	Instance
MPAM	MPAMF_BASE_ns	0x0848	MSMON_CSU_CAPTURE_ns

Accesses to this interface are RW.

MSMON_CSU_CAPTURE can be accessed through its memory-mapped interface:

Component	Frame	Offset	Instance
MPAM	MPAMF_BASE_rt	0x0848	MSMON_CSU_CAPTURE_rt

When FEAT_RME is implemented, accesses to this interface are RW.

MSMON_CSU_CAPTURE can be accessed through its memory-mapped interface:

Component	Frame	Offset	Instance
MPAM	MPAMF_BASE_r1	0x0848	MSMON_CSU_CAPTURE_r1

When FEAT_RME is implemented, accesses to this interface are RW.

11.5.9 MSMON_CSU_OFSR, MPAM CSU Monitor Overflow Status Register

The MSMON_CSU_OFSR characteristics are:

Purpose

MSMON_CSU_OFSR is a 32-bit read-only register that shows bitmap of CSU monitor instance overflow status for a contiguous group of 32 monitor instances.

MSMON_CSU_OFSR_s gives a bitmap of pending CSU overflow status for 32 Secure CSU monitor instances. MSMON_CSU_OFSR_ns gives a bitmap of pending CSU overflow status for 32 Non-secure CSU monitor instances. MSMON_CSU_OFSR_rt gives a bitmap of pending CSU overflow status for 32 Root CSU monitor instances. MSMON_CSU_OFSR_rl gives a bitmap of pending CSU overflow status for 32 Realm CSU monitor instances.

Configurations

The power domain of MSMON_CSU_OFSR is IMPLEMENTATION DEFINED.

This register is present only when MPAMF_CSUMON_IDR.HAS_OFSR == 1. Otherwise, direct accesses to MSMON_CSU_OFSR are RES0.

The power and reset domain of each MSC component is specific to that component.

Attributes

MSMON_CSU_OFSR is a 32-bit register.

Field descriptions

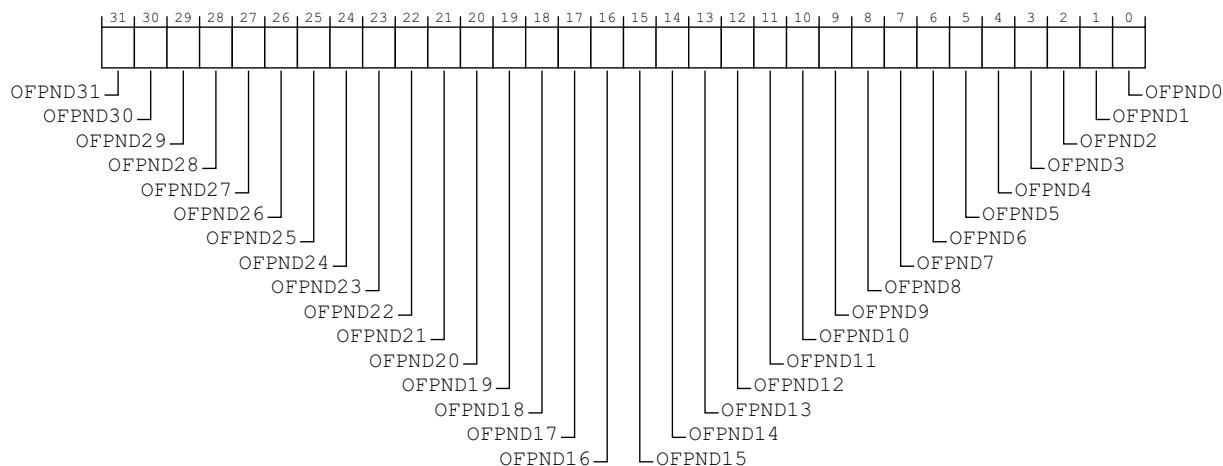

OFPND<i>, bit [i], for i = 31 to 0

Overflow status bitmap for CSU monitor instances. The RIS and the contiguous range of CSU monitor instances are set in [MSMON_CFG_MON_SEL](#). i of 0 corresponds to the CSU monitor instance [MSMON_CFG_MON_SEL.MON_SEL & 0xFFE0](#).

- 0b0 CSU monitor instance ([MSMON_CFG_MON_SEL.MON_SEL & 0xFFE0 + i](#)) does not have a pending overflow.
- 0b1 CSU monitor instance ([MSMON_CFG_MON_SEL.MON_SEL & 0xFFE0 + i](#)) has a pending overflow.

After reading [MSMON_OFLOW_SR](#) to determine that a CSU monitor instance has a pending overflow and which RIS values have pending overflows, an interrupt service routine could poll groups of 32 monitor instances in a RIS for pending monitors by reading this bitmap and incrementing [MSMON_CFG_MON_SEL.MON_SEL](#) by 32.

Accessing the MSMON_CSU_OFSR:

This register is within the MPAM feature page memory frames.

In a system that supports Secure, Non-secure, Root, and Realm memory maps, there must be MPAM feature pages in all four address maps:

- MSMON_CSU_OFSR_s must be accessible from the Secure MPAM feature page.
- MSMON_CSU_OFSR_ns must be accessible from the Non-secure MPAM feature page.
- MSMON_CSU_OFSR_rt must be accessible from the Root MPAM feature page.
- MSMON_CSU_OFSR_rl must be accessible from the Realm MPAM feature page.

MSMON_CSU_OFSR_s, MSMON_CSU_OFSR_ns, MSMON_CSU_OFSR_rt, and MSMON_CSU_OFSR_rl must be separate registers:

- The Secure instance (MSMON_CSU_OFSR_s) accesses the CSU monitor overflow status bitmap used for Secure PARTIDs.
- The Non-secure instance (MSMON_CSU_OFSR_ns) accesses the CSU monitor overflow status bitmap used for Non-secure PARTIDs.
- The Root instance (MSMON_CSU_OFSR_rt) accesses the CSU monitor overflow status bitmap used for Root PARTIDs.
- The Realm instance (MSMON_CSU_OFSR_rl) accesses the CSU monitor overflow status bitmap used for Realm PARTIDs.

MSMON_CSU_OFSR can be accessed through its memory-mapped interface:

Component	Frame	Offset	Instance
MPAM	MPAMF_BASE_s	0x0858	MSMON_CSU_OFSR_s

Accesses to this interface are RO.

MSMON_CSU_OFSR can be accessed through its memory-mapped interface:

Component	Frame	Offset	Instance
MPAM	MPAMF_BASE_ns	0x0858	MSMON_CSU_OFSR_ns

Accesses to this interface are RO.

MSMON_CSU_OFSR can be accessed through its memory-mapped interface:

Component	Frame	Offset	Instance
MPAM	MPAMF_BASE_rt	0x0858	MSMON_CSU_OFSR_rt

When FEAT_RME is implemented, accesses to this interface are RO.

MSMON_CSU_OFSR can be accessed through its memory-mapped interface:

Component	Frame	Offset	Instance
MPAM	MPAMF_BASE_rl	0x0858	MSMON_CSU_OFSR_rl

When FEAT_RME is implemented, accesses to this interface are RO.

11.5.10 MSMON_MBWU, MPAM Memory Bandwidth Usage Monitor Register

The MSMON_MBWU characteristics are:

Purpose

Accesses the monitor instance selected by [MSMON_CFG_MON_SEL](#).

MSMON_MBWU_s is the Secure memory bandwidth usage monitor instance selected by [MSMON_CFG_MON_SEL_s](#). MSMON_MBWU_ns is the Non-secure memory bandwidth usage monitor instance selected by [MSMON_CFG_MON_SEL_ns](#). MSMON_MBWU_rt is the Root memory bandwidth usage monitor instance selected by [MSMON_CFG_MON_SEL_rt](#). MSMON_MBWU_rl is the Realm memory bandwidth usage monitor instance selected by [MSMON_CFG_MON_SEL_rl](#).

If [MPAMF_IDR.HAS_RIS](#) is 1, the monitor instance register accessed is for the resource instance currently selected by [MSMON_CFG_MON_SEL.RIS](#) and the monitor instance of that resource instance selected by [MSMON_CFG_MON_SEL.MON_SEL](#).

Configurations

The power domain of MSMON_MBWU is IMPLEMENTATION DEFINED.

This register is present only when [FEAT_MPAM](#) is implemented, [MPAMF_IDR.HAS_MSMON](#) == 1 and [MPAMF_MSMON_IDR.MSMON_MBWU](#) == 1. Otherwise, direct accesses to MSMON_MBWU are RES0.

The power and reset domain of each MSC component is specific to that component.

Attributes

MSMON_MBWU is a 32-bit register.

Field descriptions



NRDY, bit [31]

Not Ready. Indicates whether the monitor has possibly inaccurate data.

0b0 The monitor instance is ready and the MSMON_MBWU.VALUE field is accurate.

0b1 The monitor instance is not ready and the contents of the MSMON_MBWU.VALUE field might be inaccurate or otherwise not represent the actual memory bandwidth usage.

VALUE, bits [30:0]

Memory bandwidth usage counter value if MSMON_MBWU.NRDY is 0. Invalid if MSMON_MBWU.NRDY is 1.

VALUE is the scaled count of bytes transferred since the monitor was last reset that met the criteria set in [MSMON_CFG_MBWU_FLT](#) and [MSMON_CFG_MBWU_CTL](#) for the monitor instance selected by [MSMON_CFG_MON_SEL](#).

If [MSMON_CFG_MBWU_CTL.SCLEN](#) enables scaling, the count in VALUE is the number of bytes shifted right by [MPAMF_MBWUMON_IDR.SCALE](#) bit positions and rounded.

Accessing the MSMON_MBWU:

This register is within the MPAM feature page memory frames.

In a system that supports Secure, Non-secure, Root, and Realm memory maps, there must be MPAM feature pages in all four address maps:

- MSMON_MBWU_s must be accessible from the Secure MPAM feature page.
- MSMON_MBWU_ns must be accessible from the Non-secure MPAM feature page.
- MSMON_MBWU_rt must be accessible from the Root MPAM feature page.
- MSMON_MBWU_rl must be accessible from the Realm MPAM feature page.

MSMON_MBWU_s, MSMON_MBWU_ns, MSMON_MBWU_rt, and MSMON_MBWU_rl must be separate registers:

- The Secure instance (MSMON_MBWU_s) accesses the memory bandwidth usage monitor used for Secure PARTIDs.
- The Non-secure instance (MSMON_MBWU_ns) accesses the memory bandwidth usage monitor used for Non-secure PARTIDs.
- The Root instance (MSMON_MBWU_rt) accesses the memory bandwidth usage monitor used for Root PARTIDs.
- The Realm instance (MSMON_MBWU_rl) accesses the memory bandwidth usage monitor used for Realm PARTIDs.

When RIS is implemented, reads and writes to MSMON_MBWU access the memory bandwidth usage monitor instance for the resource instance selected by [MSMON_CFG_MON_SEL.RIS](#) and the memory bandwidth usage monitor instance selected by [MSMON_CFG_MON_SEL.MON_SEL](#).

When RIS is not implemented, reads and writes to MSMON_MBWU access the memory bandwidth usage monitor instance for the memory bandwidth usage monitor instance selected by [MSMON_CFG_MON_SEL.MON_SEL](#).

MSMON_MBWU can be accessed through its memory-mapped interface:

Component	Frame	Offset	Instance
MPAM	MPAMF_BASE_s	0x0860	MSMON_MBWU_s

Accesses to this interface are RW.

MSMON_MBWU can be accessed through its memory-mapped interface:

Component	Frame	Offset	Instance
MPAM	MPAMF_BASE_ns	0x0860	MSMON_MBWU_ns

Accesses to this interface are RW.

MSMON_MBWU can be accessed through its memory-mapped interface:

Component	Frame	Offset	Instance
MPAM	MPAMF_BASE_rt	0x0860	MSMON_MBWU_rt

When FEAT_RME is implemented, accesses to this interface are RW.

MSMON_MBWU can be accessed through its memory-mapped interface:

Component	Frame	Offset	Instance
MPAM	MPAMF_BASE_r1	0x0860	MSMON_MBWU_r1

When FEAT_RME is implemented, accesses to this interface are RW.

11.5.11 MSMON_MBWU_CAPTURE, MPAM Memory Bandwidth Usage Monitor Capture Register

The MSMON_MBWU_CAPTURE characteristics are:

Purpose

Accesses the captured MSMON_MBWU monitor instance selected by [MSMON_CFG_MON_SEL](#).

MSMON_MBWU_CAPTURE_s is the Secure memory bandwidth usage monitor capture instance selected by the Secure instance of [MSMON_CFG_MON_SEL](#). MSMON_MBWU_CAPTURE_ns is the Non-secure memory bandwidth usage monitor capture instance selected by the Non-secure instance of [MSMON_CFG_MON_SEL](#). MSMON_MBWU_CAPTURE_rt is the Root memory bandwidth usage monitor capture instance selected by the Root instance of [MSMON_CFG_MON_SEL](#). MSMON_MBWU_CAPTURE_rl is the Realm memory bandwidth usage monitor capture instance selected by the Realm instance of [MSMON_CFG_MON_SEL](#).

If [MPAMF_IDR.HAS_RIS](#) is 1, the monitor instance capture register accessed is for the resource instance currently selected by [MSMON_CFG_MON_SEL.RIS](#) and the monitor instance of that resource instance selected by [MSMON_CFG_MON_SEL.MON_SEL](#).

Configurations

The power domain of MSMON_MBWU_CAPTURE is IMPLEMENTATION DEFINED.

This register is present only when FEAT_MPAM is implemented, [MPAMF_IDR.HAS_MSMON](#) == 1, [MPAMF_MSMON_IDR.MSMON_MBWU](#) == 1 and [MPAMF_MBWUMON_IDR.HAS_CAPTURE](#) == 1. Otherwise, direct accesses to MSMON_MBWU_CAPTURE are RES0.

The power and reset domain of each MSC component is specific to that component.

Attributes

MSMON_MBWU_CAPTURE is a 32-bit register.

Field descriptions



NRDY, bit [31]

Not Ready. The captured NRDY bit from the corresponding instance of [MSMON_MBWU](#). This bit indicates whether the captured monitor value has possibly inaccurate data.

- 0b0 The captured monitor instance was ready and the [MSMON_MBWU_CAPTURE.VALUE](#) field is accurate.
- 0b1 The captured monitor instance was not ready and the contents of the [MSMON_MBWU_CAPTURE.VALUE](#) field might be inaccurate or otherwise not represent the actual memory bandwidth usage.

VALUE, bits [30:0]

Captured memory bandwidth usage counter value if [MSMON_MBWU_CAPTURE.NRDY](#) is 0. Invalid if [MSMON_MBWU_CAPTURE.NRDY](#) is 1.

VALUE is the captured VALUE field from the corresponding instance of [MSMON_MBWU](#), the count of bytes transferred since the monitor was last reset that meet the criteria set in [MSMON_CFG_MBWU_FLT](#) and [MSMON_CFG_MBWU_CTL](#) for the monitor instance selected by [MSMON_CFG_MON_SEL](#).

VALUE captures the [MSMON_MBWU.VALUE](#) and preserves any scaling that had been performed on the VALUE field in that register.

Accessing the MSMON_MBWU_CAPTURE:

This register is within the MPAM feature page memory frames.

In a system that supports Secure, Non-secure, Root, and Realm memory maps, there must be MPAM feature pages in all four address maps:

- MSMON_MBWU_CAPTURE_s must be accessible from the Secure MPAM feature page.
- MSMON_MBWU_CAPTURE_ns must be accessible from the Non-secure MPAM feature page.
- MSMON_MBWU_CAPTURE_rt must be accessible from the Root MPAM feature page.
- MSMON_MBWU_CAPTURE_rl must be accessible from the Realm MPAM feature page.

MSMON_MBWU_CAPTURE_s, MSMON_MBWU_CAPTURE_ns, MSMON_MBWU_CAPTURE_rt, and MSMON_MBWU_CAPTURE_rl must be separate registers:

- The Secure instance (MSMON_MBWU_CAPTURE_s) accesses the captured memory bandwidth usage monitor used for Secure PARTIDs.
- The Non-secure instance (MSMON_MBWU_CAPTURE_ns) accesses the captured memory bandwidth usage monitor used for Non-secure PARTIDs.
- The Root instance (MSMON_MBWU_CAPTURE_rt) accesses the captured memory bandwidth usage monitor used for Root PARTIDs.
- The Realm instance (MSMON_MBWU_CAPTURE_rl) accesses the captured memory bandwidth usage monitor used for Realm PARTIDs.

When RIS is implemented, reads and writes to MSMON_MBWU_CAPTURE access the monitor instance for the bandwidth resource instance selected by [MSMON_CFG_MON_SEL.RIS](#) and the memory bandwidth usage monitor instance selected by [MSMON_CFG_MON_SEL.MON_SEL](#).

When RIS is not implemented, reads and writes to MSMON_MBWU_CAPTURE access the monitor instance for the memory bandwidth usage monitor instance selected by [MSMON_CFG_MON_SEL.MON_SEL](#).

MSMON_MBWU_CAPTURE can be accessed through its memory-mapped interface:

Component	Frame	Offset	Instance
MPAM	MPAMF_BASE_s	0x0868	MSMON_MBWU_CAPTURE_s

Accesses to this interface are RW.

MSMON_MBWU_CAPTURE can be accessed through its memory-mapped interface:

Component	Frame	Offset	Instance
MPAM	MPAMF_BASE_ns	0x0868	MSMON_MBWU_CAPTURE_ns

Accesses to this interface are RW.

MSMON_MBWU_CAPTURE can be accessed through its memory-mapped interface:

Component	Frame	Offset	Instance
MPAM	MPAMF_BASE_rt	0x0868	MSMON_MBWU_CAPTURE_rt

When FEAT_RME is implemented, accesses to this interface are RW.

MSMON_MBWU_CAPTURE can be accessed through its memory-mapped interface:

Component	Frame	Offset	Instance
MPAM	MPAMF_BASE_r1	0x0868	MSMON_MBWU_CAPTURE_r1

When FEAT_RME is implemented, accesses to this interface are RW.

11.5.12 MSMON_MBWU_L, MPAM Long Memory Bandwidth Usage Monitor Register

The MSMON_MBWU_L characteristics are:

Purpose

Accesses the monitor instance selected by [MSMON_CFG_MON_SEL](#).

MSMON_MBWU_L_s is the Secure long memory bandwidth usage monitor instance selected by the Secure instance of [MSMON_CFG_MON_SEL](#). MSMON_MBWU_L_ns is the Non-secure long memory bandwidth usage monitor instance selected by the Non-secure instance of [MSMON_CFG_MON_SEL](#). MSMON_MBWU_L_rt is the Root long memory bandwidth usage monitor instance selected by [MSMON_CFG_MON_SEL_rt](#). MSMON_MBWU_L_rl is the Realm long memory bandwidth usage monitor instance selected by [MSMON_CFG_MON_SEL_rl](#).

If [MPAMF_IDR.HAS_RIS](#) is 1, the monitor instance long monitor register accessed is for the resource instance currently selected by [MSMON_CFG_MON_SEL.RIS](#) and the monitor instance of that resource instance selected by [MSMON_CFG_MON_SEL.MON_SEL](#).

Configurations

The power domain of MSMON_MBWU_L is IMPLEMENTATION DEFINED.

This register is present only when [FEAT_MPAM](#) is implemented, [MPAMF_IDR.HAS_MSMON](#) == 1, [MPAMF_MSMON_IDR.MSMON_MBWU](#) == 1 and [MPAMF_MBWUMON_IDR.HAS_LONG](#) == 1. Otherwise, direct accesses to MSMON_MBWU_L are RES0.

The power and reset domain of each MSC component is specific to that component.

Attributes

MSMON_MBWU_L is a 64-bit register.

Field descriptions

When [MPAMF_MBWUMON_IDR.LWD](#) == 0:

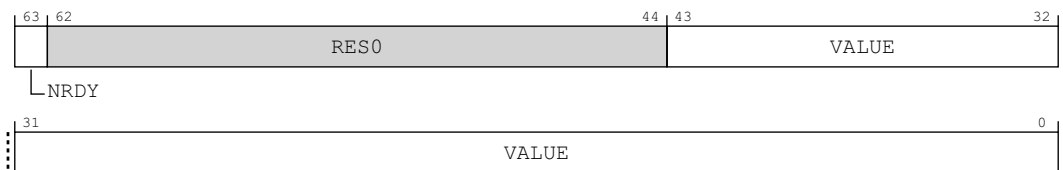

NRDY, bit [63]

Not Ready. Indicates whether the monitor instance has possibly inaccurate data.

- 0b0 The monitor instance is ready and the MSMON_MBWU_L.VALUE field is accurate.
- 0b1 The monitor instance is not ready and the contents of the MSMON_MBWU_L.VALUE field might be inaccurate or otherwise not represent the actual memory bandwidth usage.

Bits [62:44]

Reserved, RES0.

VALUE, bits [43:0]

Long (44-bit) memory bandwidth usage counter value if MSMON_MBWU_L.NRDY is 0. Invalid if MSMON_MBWU_L.NRDY is 1.

VALUE is the long count of bytes transferred since the monitor was last reset that met the criteria set in [MSMON_CFG_MBWU_FLT](#) and [MSMON_CFG_MBWU_CTL](#) for the monitor instance selected by [MSMON_CFG_MON_SEL](#).

When MPAMF_MBWUMON_IDR.LWD == 1:

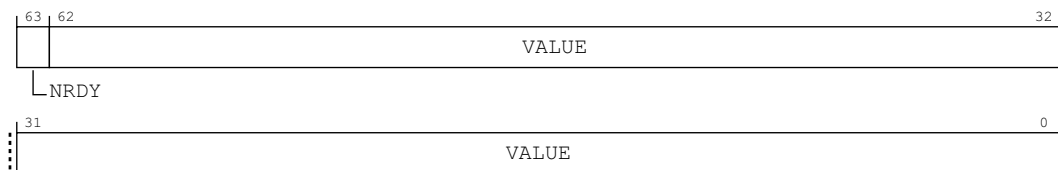

NRDY, bit [63]

Not Ready. Indicates whether the monitor instance has possibly inaccurate data.

- 0b0 The monitor instance is ready and the MSMON_MBWU_L.VALUE field is accurate.
- 0b1 The monitor instance is not ready and the contents of the MSMON_MBWU_L.VALUE field might be inaccurate or otherwise not represent the actual memory bandwidth usage.

VALUE, bits [62:0]

Long (63-bit) memory bandwidth usage counter value if MSMON_MBWU_L.NRDY is 0. Invalid if MSMON_MBWU_L.NRDY is 1.

VALUE is the long count of bytes transferred since the monitor instance was last reset that met the criteria set in [MSMON_CFG_MBWU_FLT](#) and [MSMON_CFG_MBWU_CTL](#) for the monitor instance selected by [MSMON_CFG_MON_SEL](#).

Accessing the MSMON_MBWU_L:

This register is within the MPAM feature page memory frames.

In a system that supports Secure, Non-secure, Root, and Realm memory maps, there must be MPAM feature pages in all four address maps:

- MSMON_MBWU_L_s must be accessible from the Secure MPAM feature page.
- MSMON_MBWU_L_ns must be accessible from the Non-secure MPAM feature page.
- MSMON_MBWU_L_rt must be accessible from the Root MPAM feature page.
- MSMON_MBWU_L_rl must be accessible from the Realm MPAM feature page.

MSMON_MBWU_L_s, MSMON_MBWU_L_ns, MSMON_MBWU_L_rt, and MSMON_MBWU_L_rl must be separate registers:

- The Secure instance (MSMON_MBWU_L_s) accesses the long memory bandwidth usage monitor used for Secure PARTIDs.
- The Non-secure instance (MSMON_MBWU_L_ns) accesses the long memory bandwidth usage monitor used for Non-secure PARTIDs.
- The Root instance (MSMON_MBWU_L_rt) accesses the long memory bandwidth usage monitor used for Root PARTIDs.
- The Realm instance (MSMON_MBWU_L_rl) accesses the long memory bandwidth usage monitor used for Realm PARTIDs.

When RIS is implemented, reads and writes to MSMON_MBWU_L access the long memory bandwidth usage monitor instance for the bandwidth resource instance selected by [MSMON_CFG_MON_SEL.RIS](#) and the monitor instance selected by [MSMON_CFG_MON_SEL.MON_SEL](#).

When RIS is not implemented, reads and writes to MSMON_MBWU_L access the long memory bandwidth usage monitor instance for the monitor instance selected by [MSMON_CFG_MON_SEL.MON_SEL](#).

MSMON_MBWU_L can be accessed through its memory-mapped interface:

Component	Frame	Offset	Instance
MPAM	MPAMF_BASE_s	0x0880	MSMON_MBWU_s

Accesses to this interface are RW.

MSMON_MBWU_L can be accessed through its memory-mapped interface:

Component	Frame	Offset	Instance
MPAM	MPAMF_BASE_ns	0x0880	MSMON_MBWU_ns

Accesses to this interface are RW.

MSMON_MBWU_L can be accessed through its memory-mapped interface:

Component	Frame	Offset	Instance
MPAM	MPAMF_BASE_rt	0x0880	MSMON_MBWU_rt

When FEAT_RME is implemented, accesses to this interface are RW.

MSMON_MBWU_L can be accessed through its memory-mapped interface:

Component	Frame	Offset	Instance
MPAM	MPAMF_BASE_rl	0x0880	MSMON_MBWU_rl

When FEAT_RME is implemented, accesses to this interface are RW.

11.5.13 MSMON_MBWU_L_CAPTURE, MPAM Long Memory Bandwidth Usage Monitor Capture Register

The MSMON_MBWU_L_CAPTURE characteristics are:

Purpose

Accesses the captured [MSMON_MBWU_L](#) monitor instance selected by [MSMON_CFG_MON_SEL](#).

MSMON_MBWU_L_CAPTURE_s is the Secure long memory bandwidth usage monitor capture instance selected by the Secure instance of [MSMON_CFG_MON_SEL](#).

MSMON_MBWU_L_CAPTURE_ns is the Non-secure long memory bandwidth usage monitor capture instance selected by the Non-secure instance of [MSMON_CFG_MON_SEL](#).

MSMON_MBWU_L_CAPTURE_rt is the Root long memory bandwidth usage monitor capture instance selected by the Root instance of [MSMON_CFG_MON_SEL](#).

MSMON_MBWU_L_CAPTURE_rl is the Realm long memory bandwidth usage monitor capture instance selected by the Realm instance of [MSMON_CFG_MON_SEL](#).

If [MPAMF_IDR.HAS_RIS](#) is 1, the monitor instance long capture register accessed is for the resource instance currently selected by [MSMON_CFG_MON_SEL.RIS](#) and the monitor instance of that resource instance selected by [MSMON_CFG_MON_SEL.MON_SEL](#).

Configurations

The power domain of MSMON_MBWU_L_CAPTURE is IMPLEMENTATION DEFINED.

This register is present only when FEAT_MPAM is implemented, [MPAMF_IDR.HAS_MSMON](#) == 1, [MPAMF_MSMON_IDR.MSMON_MBWU](#) == 1, [MPAMF_MBWUMON_IDR.HAS_CAPTURE](#) == 1 and [MPAMF_MBWUMON_IDR.HAS_LONG](#) == 1. Otherwise, direct accesses to MSMON_MBWU_L_CAPTURE are RES0.

The power and reset domain of each MSC component is specific to that component.

Attributes

MSMON_MBWU_L_CAPTURE is a 64-bit register.

Field descriptions

When [MPAMF_MBWUMON_IDR.LWD](#) == 0:

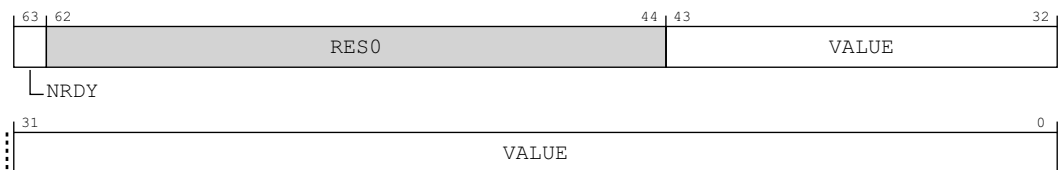

NRDY, bit [63]

Not Ready. Indicates whether the monitor has possibly inaccurate data.

0b0 The captured monitor instance was ready and the MSMON_MBWU_L_CAPTURE.VALUE field is accurate.

0b1 The captured monitor instance was not ready and the contents of the MSMON_MBWU_L_CAPTURE.VALUE field might be inaccurate or otherwise not represent the actual memory bandwidth usage.

Bits [62:44]

Reserved, RES0.

VALUE, bits [43:0]

Captured long memory bandwidth usage counter value if `MSMON_MBWU_L_CAPTURE.NRDY` is 0. Invalid if `MSMON_MBWU_L_CAPTURE.NRDY` is 1.

VALUE is the captured 44-bit count of bytes transferred since the monitor instance was last reset that met the criteria set in `MSMON_CFG_MBWU_FLT` and `MSMON_CFG_MBWU_CTL` for the monitor instance selected by `MSMON_CFG_MON_SEL`.

When `MPAMF_MBWUMON_IDR.LWD == 1`:

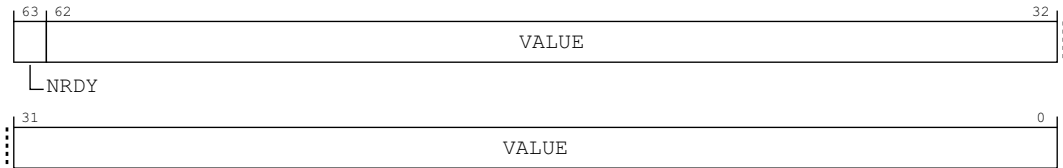

NRDY, bit [63]

Not Ready. Indicates whether the monitor has possibly inaccurate data.

- 0b0 The captured monitor instance was ready and the `MSMON_MBWU_L_CAPTURE.VALUE` field is accurate.
- 0b1 The captured monitor instance was not ready and the contents of the `MSMON_MBWU_L_CAPTURE.VALUE` field might be inaccurate or otherwise not represent the actual memory bandwidth usage.

VALUE, bits [62:0]

The captured long memory bandwidth usage counter value if `MSMON_MBWU_L_CAPTURE.NRDY` is 0. Invalid if `MSMON_MBWU_L_CAPTURE.NRDY` is 1.

VALUE is the captured 63-bit count of bytes transferred since the monitor instance was last reset that met the criteria set in `MSMON_CFG_MBWU_FLT` and `MSMON_CFG_MBWU_CTL` for the monitor instance selected by `MSMON_CFG_MON_SEL`.

Accessing the `MSMON_MBWU_L_CAPTURE`:

This register is within the MPAM feature page memory frames.

In a system that supports Secure, Non-secure, Root, and Realm memory maps, there must be MPAM feature pages in all four address maps:

- `MSMON_MBWU_L_CAPTURE_s` must be accessible from the Secure MPAM feature page.
- `MSMON_MBWU_L_CAPTURE_ns` must be accessible from the Non-secure MPAM feature page.
- `MSMON_MBWU_L_CAPTURE_rt` must be accessible from the Root MPAM feature page.
- `MSMON_MBWU_L_CAPTURE_rl` must be accessible from the Realm MPAM feature page.

`MSMON_MBWU_L_CAPTURE_s`, `MSMON_MBWU_L_CAPTURE_ns`, `MSMON_MBWU_L_CAPTURE_rt`, and `MSMON_MBWU_L_CAPTURE_rl` must be separate registers:

- The Secure instance (`MSMON_MBWU_L_CAPTURE_s`) accesses the captured long memory bandwidth usage monitor used for Secure PARTIDs.
- The Non-secure instance (`MSMON_MBWU_L_CAPTURE_ns`) accesses the captured long memory bandwidth usage monitor used for Non-secure PARTIDs.
- The Root instance (`MSMON_MBWU_L_CAPTURE_rt`) accesses the captured long memory bandwidth usage monitor used for Root PARTIDs.

- The Realm instance (MSMON_MBWU_L_CAPTURE_rl) accesses the captured long memory bandwidth usage monitor used for Realm PARTIDs.

When RIS is implemented, reads and writes to MSMON_MBWU_L_CAPTURE access the monitor instance for the bandwidth resource instance selected by `MSMON_CFG_MON_SEL.RIS` and the memory bandwidth usage monitor instance selected by `MSMON_CFG_MON_SEL.MON_SEL`.

When RIS is not implemented, reads and writes to MSMON_MBWU_L_CAPTURE access the monitor instance for the memory bandwidth usage monitor instance selected by `MSMON_CFG_MON_SEL.MON_SEL`.

MSMON_MBWU_L_CAPTURE can be accessed through its memory-mapped interface:

Component	Frame	Offset	Instance
MPAM	MPAMF_BASE_s	0x0890	MSMON_MBWU_CAPTURE_s

Accesses to this interface are RW.

MSMON_MBWU_L_CAPTURE can be accessed through its memory-mapped interface:

Component	Frame	Offset	Instance
MPAM	MPAMF_BASE_ns	0x0890	MSMON_MBWU_CAPTURE_ns

Accesses to this interface are RW.

MSMON_MBWU_L_CAPTURE can be accessed through its memory-mapped interface:

Component	Frame	Offset	Instance
MPAM	MPAMF_BASE_rt	0x0890	MSMON_MBWU_CAPTURE_rt

When FEAT_RME is implemented, accesses to this interface are RW.

MSMON_MBWU_L_CAPTURE can be accessed through its memory-mapped interface:

Component	Frame	Offset	Instance
MPAM	MPAMF_BASE_rl	0x0890	MSMON_MBWU_CAPTURE_rl

When FEAT_RME is implemented, accesses to this interface are RW.

11.5.14 MSMON_MBWU_OFSR, MPAM MBWU Monitor Overflow Status Register

The MSMON_MBWU_OFSR characteristics are:

Purpose

MSMON_MBWU_OFSR is a 32-bit read-only register that shows bitmap of MBWU monitor instance overflow status for a contiguous group of 32 monitor instances.

MSMON_MBWU_OFSR_s gives a bitmap of pending MBWU overflow status for 32 Secure MBWU monitor instances. MSMON_MBWU_OFSR_ns gives a bitmap of pending MBWU overflow status for 32 Non-secure MBWU monitor instances. MSMON_MBWU_OFSR_rt gives a bitmap of pending MBWU overflow status for 32 Root MBWU monitor instances. MSMON_MBWU_OFSR_rl gives a bitmap of pending MBWU overflow status for 32 Realm MBWU monitor instances.

Configurations

The power domain of MSMON_MBWU_OFSR is IMPLEMENTATION DEFINED.

This register is present only when MPAMF_MBWUMON_IDR.HAS_OFSR == 1. Otherwise, direct accesses to MSMON_MBWU_OFSR are RES0.

The power and reset domain of each MSC component is specific to that component.

Attributes

MSMON_MBWU_OFSR is a 32-bit register.

Field descriptions

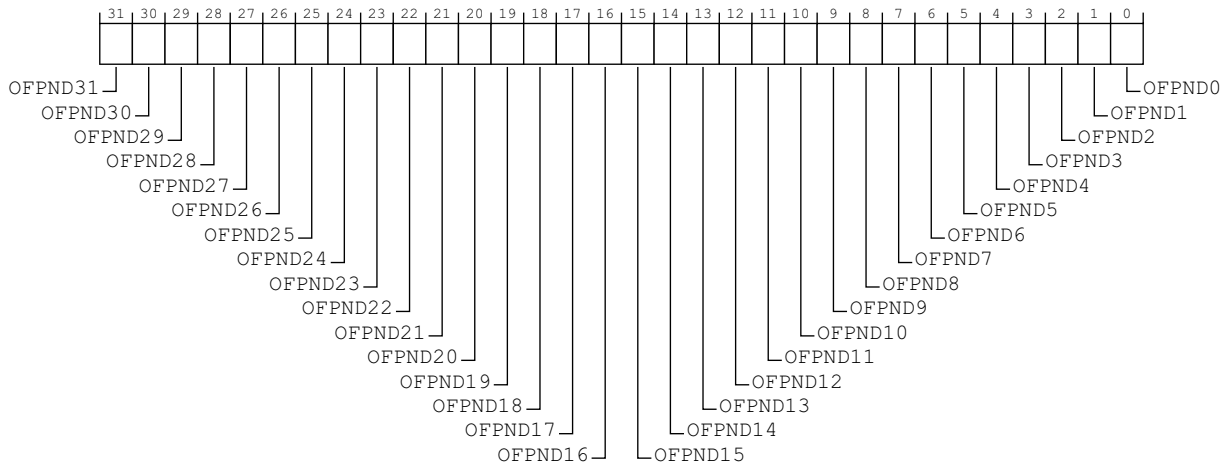

OFND<i>, bit [i], for i = 31 to 0

Overflow status bitmap for MBWU monitor instances. The RIS and the contiguous range of MBWU monitor instances are set in `MSMON_CFG_MON_SEL`. `i` of 0 corresponds to the MBWU monitor instance `MSMON_CFG_MON_SEL.MON_SEL & 0xFFE0`.

- 0b0 MBWU monitor instance (`MSMON_CFG_MON_SEL.MON_SEL & 0xFFE0 + i`) does not have a pending overflow.
- 0b1 MBWU monitor instance (`MSMON_CFG_MON_SEL.MON_SEL & 0xFFE0 + i`) has a pending overflow.

After reading `MSMON_OFLOW_SR` to determine that an MBWU monitor instance has a pending overflow and which RIS values have pending overflows, an interrupt service routine could poll groups of 32 monitor instances in a RIS for pending monitors by reading this bitmap and incrementing `MSMON_CFG_MON_SEL.MON_SEL` by 32.

A pending overflow may be in either the `MSMON_CFG_MBWU_CTL.OFLOW_STATUS` or `MSMON_CFG_MBWU_CTL.OFLOW_STATUS_L` field.

Accessing the `MSMON_MBWU_OFSR`:

This register is within the MPAM feature page memory frames.

In a system that supports Secure, Non-secure, Root, and Realm memory maps, there must be MPAM feature pages in all four address maps:

- `MSMON_MBWU_OFSR_s` must be accessible from the Secure MPAM feature page.
- `MSMON_MBWU_OFSR_ns` must be accessible from the Non-secure MPAM feature page.
- `MSMON_MBWU_OFSR_rt` must be accessible from the Root MPAM feature page.
- `MSMON_MBWU_OFSR_rl` must be accessible from the Realm MPAM feature page.

`MSMON_MBWU_OFSR_s`, `MSMON_MBWU_OFSR_ns`, `MSMON_MBWU_OFSR_rt`, and `MSMON_MBWU_OFSR_rl` must be separate registers:

- The Secure instance (`MSMON_MBWU_OFSR_s`) accesses the MBWU monitor overflow status bitmap used for Secure PARTIDs.
- The Non-secure instance (`MSMON_MBWU_OFSR_ns`) accesses the MBWU monitor overflow status bitmap used for Non-secure PARTIDs.
- The Root instance (`MSMON_MBWU_OFSR_rt`) accesses the MBWU monitor overflow status bitmap used for Root PARTIDs.
- The Realm instance (`MSMON_MBWU_OFSR_rl`) accesses the MBWU monitor overflow status bitmap used for Realm PARTIDs.

`MSMON_MBWU_OFSR` can be accessed through its memory-mapped interface:

Component	Frame	Offset	Instance
MPAM	MPAMF_BASE_s	0x0898	MSMON_MBWU_OFSR_s

Accesses to this interface are RO.

`MSMON_MBWU_OFSR` can be accessed through its memory-mapped interface:

Component	Frame	Offset	Instance
MPAM	MPAMF_BASE_ns	0x0898	MSMON_MBWU_OFSR_ns

Accesses to this interface are RO.

`MSMON_MBWU_OFSR` can be accessed through its memory-mapped interface:

Component	Frame	Offset	Instance
MPAM	MPAMF_BASE_rt	0x0898	MSMON_MBWU_OFSR_rt

When FEAT_RME is implemented, accesses to this interface are RO.

MSMON_MBWU_OFSR can be accessed through its memory-mapped interface:

Component	Frame	Offset	Instance
MPAM	MPAMF_BASE_r1	0x0898	MSMON_MBWU_OFSR_r1

When FEAT_RME is implemented, accesses to this interface are RO.

11.5.15 MSMON_OFLOW_MSI_ADDR_H, MPAM Monitor Overflow MSI Write High-part Address Register

The MSMON_OFLOW_MSI_ADDR_H characteristics are:

Purpose

MSMON_OFLOW_MSI_ADDR_H is a 32-bit read/write register for the high part of the MPAM monitor overflow MSI address.

MSMON_OFLOW_MSI_ADDR_H_s is the high part of the MSI write address for monitor overflow interrupts from Secure monitor instances. MSMON_OFLOW_MSI_ADDR_H_ns is the high part of the MSI write address for monitor overflow interrupts from Non-secure monitor instances. MSMON_OFLOW_MSI_ADDR_H_rt is the high part of the MSI write address for monitor overflow interrupts from Root monitor instances. MSMON_OFLOW_MSI_ADDR_H_rl is the high part of the MSI write address for monitor overflow interrupts from Realm monitor instances.

Configurations

The power domain of MSMON_OFLOW_MSI_ADDR_H is IMPLEMENTATION DEFINED.

This register is present only when FEAT_MPAMv1p1 is implemented and MPAMF_MSMON_IDR.HAS_OFLOW_MSI == 1. Otherwise, direct accesses to MSMON_OFLOW_MSI_ADDR_H are RES0.

[MSMON_OFLOW_MSI_ADDR_L](#), [MSMON_OFLOW_MSI_ADDR_H](#), [MSMON_OFLOW_MSI_ATTR](#), [MSMON_OFLOW_MSI_DATA](#), and [MSMON_OFLOW_MSI_MPAM](#) must all be implemented to support MSI writes for monitor overflow interrupts.

The power and reset domain of each MSC component is specific to that component.

Attributes

MSMON_OFLOW_MSI_ADDR_H is a 32-bit register.

Field descriptions



Bits [31:20]

Reserved, RES0.

MSI_ADDR_H, bits [19:0]

MSI write address bits[51:32].

Accessing the MSMON_OFLOW_MSI_ADDR_H:

This register is within the MPAM feature page memory frames.

In a system that supports Secure, Non-secure, Root, and Realm memory maps, there must be MPAM feature pages in all four address maps:

- MSMON_OFLOW_MSI_ADDR_H_s must be accessible from the Secure MPAM feature page.
- MSMON_OFLOW_MSI_ADDR_H_ns must be accessible from the Non-secure MPAM feature page.
- MSMON_OFLOW_MSI_ADDR_H_rt must be accessible from the Root MPAM feature page.
- MSMON_OFLOW_MSI_ADDR_H_rl must be accessible from the Realm MPAM feature page.

MSMON_OFLW_MSI_ADDR_H_s, MSMON_OFLW_MSI_ADDR_H_ns, MSMON_OFLW_MSI_ADDR_H_rt, and MSMON_OFLW_MSI_ADDR_H_rl must be separate registers:

- The Secure instance (MSMON_OFLW_MSI_ADDR_H_s) accesses the high part of the monitor overflow MSI write address of Secure monitors.
- The Non-secure instance (MSMON_OFLW_MSI_ADDR_H_ns) accesses the high part of the monitor overflow MSI write address of Non-secure monitors.
- The Root instance (MSMON_OFLW_MSI_ADDR_H_rt) accesses the high part of the monitor overflow MSI write address of Root monitors.
- The Realm instance (MSMON_OFLW_MSI_ADDR_H_rl) accesses the high part of the monitor overflow MSI write address of Realm monitors.

MSMON_OFLOW_MSI_ADDR_H can be accessed through its memory-mapped interface:

Component	Frame	Offset	Instance
MPAM	MPAMF_BASE_s	0x08E4	MSMON_OFLW_MSI_ADDR_H_s

Accesses to this interface are RW.

MSMON_OFLOW_MSI_ADDR_H can be accessed through its memory-mapped interface:

Component	Frame	Offset	Instance
MPAM	MPAMF_BASE_ns	0x08E4	MSMON_OFLW_MSI_ADDR_H_ns

Accesses to this interface are RW.

MSMON_OFLOW_MSI_ADDR_H can be accessed through its memory-mapped interface:

Component	Frame	Offset	Instance
MPAM	MPAMF_BASE_rt	0x08E4	MSMON_OFLW_MSI_ADDR_H_rt

When FEAT_RME is implemented, accesses to this interface are RW.

MSMON_OFLOW_MSI_ADDR_H can be accessed through its memory-mapped interface:

Component	Frame	Offset	Instance
MPAM	MPAMF_BASE_rl	0x08E4	MSMON_OFLW_MSI_ADDR_H_rl

When FEAT_RME is implemented, accesses to this interface are RW.

11.5.16 MSMON_OFLOW_MSI_ADDR_L, MPAM Monitor Overflow MSI Low-part Address Register

The MSMON_OFLOW_MSI_ADDR_L characteristics are:

Purpose

MSMON_OFLOW_MSI_ADDR_L is a 32-bit read/write register for the low part of the MPAM monitor MSI address.

MSMON_OFLOW_MSI_ADDR_L_s is the low part of the MSI write address for overflow interrupts from Secure monitor instances. MSMON_OFLOW_MSI_ADDR_L_ns is the low part of the MSI write address for overflow interrupts from Non-secure monitor instances.

MSMON_OFLOW_MSI_ADDR_L_rt is the low part of the MSI write address for overflow interrupts from Root monitor instances. MSMON_OFLOW_MSI_ADDR_L_rl is the low part of the MSI write address for overflow interrupts from Realm monitor instances.

Configurations

The power domain of MSMON_OFLOW_MSI_ADDR_L is IMPLEMENTATION DEFINED.

This register is present only when FEAT_MPAMv1p1 is implemented and MPAMF_MSMON_IDR.HAS_OFLOW_MSI == 1. Otherwise, direct accesses to MSMON_OFLOW_MSI_ADDR_L are RES0.

[MSMON_OFLOW_MSI_ADDR_L](#), [MSMON_OFLOW_MSI_ADDR_H](#), [MSMON_OFLOW_MSI_ATTR](#), [MSMON_OFLOW_MSI_DATA](#), and [MSMON_OFLOW_MSI_MPAM](#) must all be implemented to support MSI writes for monitor overflow interrupts.

The power and reset domain of each MSC component is specific to that component.

Attributes

MSMON_OFLOW_MSI_ADDR_L is a 32-bit register.

Field descriptions



MSI_ADDR_L, bits [31:2]

MSI write address bits[31:2].

Bits [1:0]

Reads as 0b00.

Access to this field is RO.

Accessing the MSMON_OFLOW_MSI_ADDR_L:

This register is within the MPAM feature page memory frames.

In a system that supports Secure, Non-secure, Root, and Realm memory maps, there must be MPAM feature pages in all four address maps:

- MSMON_OFLOW_MSI_ADDR_L_s must be accessible from the Secure MPAM feature page.
- MSMON_OFLOW_MSI_ADDR_L_ns must be accessible from the Non-secure MPAM feature page.
- MSMON_OFLOW_MSI_ADDR_L_rt must be accessible from the Root MPAM feature page.
- MSMON_OFLOW_MSI_ADDR_L_rl must be accessible from the Realm MPAM feature page.

MSMON_OFLOW_MSI_ADDR_L_s, MSMON_OFLOW_MSI_ADDR_L_ns, MSMON_OFLOW_MSI_ADDR_L_rt, and MSMON_OFLOW_MSI_ADDR_L_rl must be separate registers:

- The Secure instance (MSMON_OFLOW_MSI_ADDR_L_s) accesses the low part of the overflow MSI write address used for Secure PARTIDs.
- The Non-secure instance (MSMON_OFLOW_MSI_ADDR_L_ns) accesses the low part of the overflow MSI write address used for Non-secure PARTIDs.
- The Root instance (MSMON_OFLOW_MSI_ADDR_L_rt) accesses the low part of the overflow MSI write address used for Root PARTIDs.
- The Realm instance (MSMON_OFLOW_MSI_ADDR_L_rl) accesses the low part of the overflow MSI write address used for Realm PARTIDs.

MSMON_OFLOW_MSI_ADDR_L can be accessed through its memory-mapped interface:

Component	Frame	Offset	Instance
MPAM	MPAMF_BASE_s	0x08E0	MSMON_OFLOW_MSI_ADDR_L_s

Accesses to this interface are RW.

MSMON_OFLOW_MSI_ADDR_L can be accessed through its memory-mapped interface:

Component	Frame	Offset	Instance
MPAM	MPAMF_BASE_ns	0x08E0	MSMON_OFLOW_MSI_ADDR_L_ns

Accesses to this interface are RW.

MSMON_OFLOW_MSI_ADDR_L can be accessed through its memory-mapped interface:

Component	Frame	Offset	Instance
MPAM	MPAMF_BASE_rt	0x08E0	MSMON_OFLOW_MSI_ADDR_L_rt

When FEAT_RME is implemented, accesses to this interface are RW.

MSMON_OFLOW_MSI_ADDR_L can be accessed through its memory-mapped interface:

Component	Frame	Offset	Instance
MPAM	MPAMF_BASE_rl	0x08E0	MSMON_OFLOW_MSI_ADDR_L_rl

When FEAT_RME is implemented, accesses to this interface are RW.

11.5.17 MSMON_OFLOW_MSI_ATTR, MPAM Monitor Overflow MSI Write Attributes Register

The MSMON_OFLOW_MSI_ATTR characteristics are:

Purpose

MSMON_OFLOW_MSI_ATTR is a 32-bit read/write register that controls MPAM monitor overflow MSI write attributes for MPAM monitor overflows in this MSC.

MSMON_OFLOW_MSI_ATTR_s controls Secure MPAM monitor overflow MSI writes.
MSMON_OFLOW_MSI_ATTR_ns controls Non-secure MPAM monitor overflow MSI writes.
MSMON_OFLOW_MSI_ATTR_rt controls Root MPAM monitor overflow MSI writes.
MSMON_OFLOW_MSI_ATTR_rl controls Realm MPAM monitor overflow MSI writes.

Configurations

The power domain of MSMON_OFLOW_MSI_ATTR is IMPLEMENTATION DEFINED.

This register is present only when FEAT_MPAMv1p1 is implemented and MPAMF_MSMON_IDR.HAS_OFLW_MSI == 1. Otherwise, direct accesses to MSMON_OFLOW_MSI_ATTR are RES0.

[MSMON_OFLOW_MSI_ADDR_L](#), [MSMON_OFLOW_MSI_ADDR_H](#), [MSMON_OFLOW_MSI_ATTR](#), [MSMON_OFLOW_MSI_DATA](#), and [MSMON_OFLOW_MSI_MPAM](#) must all be implemented to support MSI writes for monitor overflow interrupts.

The power and reset domain of each MSC component is specific to that component.

Attributes

MSMON_OFLOW_MSI_ATTR is a 32-bit register.

Field descriptions



Bits [31:30]

Reserved, RES0.

MSI_SH, bits [29:28]

Sharability attribute of MSI writes.

- 0b00 Non-shareable.
- 0b01 Reserved, CONSTRAINED UNPREDICTABLE.
- 0b10 Outer Shareable.
- 0b11 Inner Shareable.

When MSMON_OFLOW_MSI_ATTR.MSI_MEMATTR specifies a Device memory type, the contents of this field are IGNORED and Shareability is effectively Outer Shareable.

MSI_MEMATTR, bits [27:24]

Memory attributes of MSI writes.

Note: This encoding matches the VMSAv8-64 stage 2 MemAttr[3:0] field as described in the Arm ARM, except that the following encodings are Reserved (not UNPREDICTABLE) and behave as Device-nGnRnE: 0b0100, 0b1000, and 0b1100.

- 0b0000 Device-nGnRnE.
- 0b0001 Device-nGnRE.
- 0b0010 Device-nGRE.

0b0011	Device-GRE.
0b0100	Reserved. Behave as Device-nGnRnE, 0b0000.
0b0101	Normal Inner Non-cacheable, Outer Non-cacheable.
0b0110	Normal Inner Write-Through Cacheable, Outer Non-cacheable.
0b0111	Normal Inner Write-Back Cacheable, Outer Non-cacheable.
0b1000	Reserved. Behave as Device-nGnRnE, 0b0000.
0b1001	Normal Inner Non-Cachable, Outer Write-Through Cacheable.
0b1010	Normal Inner Write-Through Cacheable, Outer Write-Through Cachable.
0b1011	Normal Inner Write-Back Cacheable, Outer Write-Through Cachable.
0b1100	Reserved. Behave as Device-nGnRnE, 0b0000.
0b1101	Normal Inner Non-cacheable, Outer Write-Back Cacheable.
0b1110	Normal Inner Write-Through Cacheable, Outer Write-Back Cacheable.
0b1111	Normal Inner Write-Back Cacheable, Outer Write-Back Cacheable.

When this field specifies a Device memory type, the contents of MSMON_OFLOW_MSI_ATTR.MSI_SH are IGNORED and Shareability is effectively Outer Shareable.

Device types may be implemented as any Device type with more n characters. For example, if this field is set to 0b0010, an implementation may treat the MSI write as the specified type, Device-nGRE, or as Device-nGnRE or as Device-nGnRnE.

Reserved encodings 0b0100, 0b1000, and 0b1100 must be implemented to behave the same as the 0b0000 encoding.

Bits [23:1]

Reserved, RES0.

MSIEN, bit [0]

Monitor overflow MSI write enable.

0b0	MPAM monitor overflow MSI writes are not generated to signal enabled MPAM monitor overflow interrupts. When monitor overflow MSI writes are disabled, hardwired monitor overflow interrupt could be generated if hardwired monitor overflow interrupt is implemented.
0b1	MPAM monitor overflow MSI writes are generated to signal enabled MPAM monitor overflow interrupts. When monitor overflow MSI writes are enabled, hardwired monitor overflow interrupts are not generated.

This enable affects whether a hardwired overflow interrupt is generated.

The reset behavior of this field is:

- On a MSC reset, this field resets to 0.

Accessing the MSMON_OFLOW_MSI_ATTR:

This register is within the MPAM feature page memory frames.

In a system that supports Secure, Non-secure, Root, and Realm memory maps, there must be MPAM feature pages in all four address maps:

- MSMON_OFLOW_MSI_ATTR_s must be accessible from the Secure MPAM feature page.
- MSMON_OFLOW_MSI_ATTR_ns must be accessible from the Non-secure MPAM feature page.
- MSMON_OFLOW_MSI_ATTR_rt must be accessible from the Root MPAM feature page.
- MSMON_OFLOW_MSI_ATTR_rl must be accessible from the Realm MPAM feature page.

MSMON_OFLOW_MSI_ATTR_s, MSMON_OFLOW_MSI_ATTR_ns, MSMON_OFLOW_MSI_ATTR_rt, and MSMON_OFLOW_MSI_ATTR_rl must be separate registers:

- The Secure instance (MSMON_OFLOW_MSI_ATTR_s) accesses the monitor overflow MSI write attributes of Secure monitors.
- The Non-secure instance (MSMON_OFLOW_MSI_ATTR_ns) accesses the monitor overflow MSI write attributes of Non-secure monitors.
- The Root instance (MSMON_OFLOW_MSI_ATTR_rt) accesses the monitor overflow MSI write attributes of Root monitors.
- The Realm instance (MSMON_OFLOW_MSI_ATTR_rl) accesses the monitor overflow MSI write attributes of Realm monitors.

MSMON_OFLOW_MSI_ATTR can be accessed through its memory-mapped interface:

Component	Frame	Offset	Instance
MPAM	MPAMF_BASE_s	0x08EC	MSMON_OFLOW_MSI_ATTR_s

Accesses to this interface are RW.

MSMON_OFLOW_MSI_ATTR can be accessed through its memory-mapped interface:

Component	Frame	Offset	Instance
MPAM	MPAMF_BASE_ns	0x08EC	MSMON_OFLOW_MSI_ATTR_ns

Accesses to this interface are RW.

MSMON_OFLOW_MSI_ATTR can be accessed through its memory-mapped interface:

Component	Frame	Offset	Instance
MPAM	MPAMF_BASE_rt	0x08EC	MSMON_OFLOW_MSI_ATTR_rt

When FEAT_RME is implemented, accesses to this interface are RW.

MSMON_OFLOW_MSI_ATTR can be accessed through its memory-mapped interface:

Component	Frame	Offset	Instance
MPAM	MPAMF_BASE_rl	0x08EC	MSMON_OFLOW_MSI_ATTR_rl

When FEAT_RME is implemented, accesses to this interface are RW.

11.5.18 MSMON_OFLOW_MSI_DATA, MPAM Monitor Overflow MSI Write Data Register

The MSMON_OFLOW_MSI_DATA characteristics are:

Purpose

MSMON_OFLOW_MSI_DATA is a 32-bit read/write register for the MPAM monitor overflow MSI data.

MSMON_OFLOW_MSI_DATA_s is the data for the MSI write for monitor overflow from Secure monitor instances. MSMON_OFLOW_MSI_DATA_ns is the data for the MSI writes for monitor overflow interrupts from Non-secure monitor instances. MSMON_OFLOW_MSI_DATA_rt is the data for the MSI write for monitor overflow from Root monitor instances.

MSMON_OFLOW_MSI_DATA_rl is the data for the MSI writes for monitor overflow interrupts from Realm monitor instances.

Configurations

The power domain of MSMON_OFLOW_MSI_DATA is IMPLEMENTATION DEFINED.

This register is present only when FEAT_MPAMv1p1 is implemented and MPAMF_MSMON_IDR.HAS_OFLW_MSI == 1. Otherwise, direct accesses to MSMON_OFLOW_MSI_DATA are RES0.

[MSMON_OFLOW_MSI_ADDR_L](#), [MSMON_OFLOW_MSI_ADDR_H](#), [MSMON_OFLOW_MSI_ATTR](#), [MSMON_OFLOW_MSI_DATA](#), and [MSMON_OFLOW_MSI_MPAM](#) must all be implemented to support MSI writes for monitor overflow interrupts.

The power and reset domain of each MSC component is specific to that component.

Attributes

MSMON_OFLOW_MSI_DATA is a 32-bit register.

Field descriptions



MSI_DATA, bits [31:0]

MSI write data word.

Accessing the MSMON_OFLOW_MSI_DATA:

This register is within the MPAM feature page memory frames.

In a system that supports Secure, Non-secure, Root, and Realm memory maps, there must be MPAM feature pages in all four address maps:

- MSMON_OFLOW_MSI_DATA_s must be accessible from the Secure MPAM feature page.
- MSMON_OFLOW_MSI_DATA_ns must be accessible from the Non-secure MPAM feature page.
- MSMON_OFLOW_MSI_DATA_rt must be accessible from the Root MPAM feature page.
- MSMON_OFLOW_MSI_DATA_rl must be accessible from the Realm MPAM feature page.

MSMON_OFLOW_MSI_DATA_s, MSMON_OFLOW_MSI_DATA_ns, MSMON_OFLOW_MSI_DATA_rt, and MSMON_OFLOW_MSI_DATA_rl must be separate registers:

- The Secure instance (MSMON_OFLOW_MSI_DATA_s) accesses the monitor overflow MSI write data of Secure monitors.

- The Non-secure instance (MSMON_OFLOW_MSI_DATA_ns) accesses the monitor overflow MSI write data of Non-secure monitors.
- The Root instance (MSMON_OFLOW_MSI_DATA_rt) accesses the monitor overflow MSI write data of Root monitors.
- The Realm instance (MSMON_OFLOW_MSI_DATA_rl) accesses the monitor overflow MSI write data of Realm monitors.

MSMON_OFLOW_MSI_DATA can be accessed through its memory-mapped interface:

Component	Frame	Offset	Instance
MPAM	MPAMF_BASE_s	0x08E8	MSMON_OFLOW_MSI_DATA_s

Accesses to this interface are RW.

MSMON_OFLOW_MSI_DATA can be accessed through its memory-mapped interface:

Component	Frame	Offset	Instance
MPAM	MPAMF_BASE_ns	0x08E8	MSMON_OFLOW_MSI_DATA_ns

Accesses to this interface are RW.

MSMON_OFLOW_MSI_DATA can be accessed through its memory-mapped interface:

Component	Frame	Offset	Instance
MPAM	MPAMF_BASE_rt	0x08E8	MSMON_OFLOW_MSI_DATA_rt

When FEAT_RME is implemented, accesses to this interface are RW.

MSMON_OFLOW_MSI_DATA can be accessed through its memory-mapped interface:

Component	Frame	Offset	Instance
MPAM	MPAMF_BASE_rl	0x08E8	MSMON_OFLOW_MSI_DATA_rl

When FEAT_RME is implemented, accesses to this interface are RW.

11.5.19 MSMON_OFLOW_MSI_MPAM, MPAM Monitor Overflow MSI Write MPAM Information Register

The MSMON_OFLOW_MSI_MPAM characteristics are:

Purpose

MSMON_OFLOW_MSI_MPAM is a 32-bit read/write register that sets the MPAM information for a monitor overflow MSI write.

MSMON_OFLOW_MSI_MPAM_s controls MPAM information labeling of Secure monitor overflow MSI writes. MSMON_OFLOW_MSI_MPAM_ns controls MPAM information labeling of Non-secure monitor overflow MSI writes. MSMON_OFLOW_MSI_MPAM_rt controls MPAM information labeling of Root monitor overflow MSI writes. MSMON_OFLOW_MSI_MPAM_rl controls MPAM information labeling of Realm monitor overflow MSI writes.

Configurations

The power domain of MSMON_OFLOW_MSI_MPAM is IMPLEMENTATION DEFINED.

This register is present only when FEAT_MPAMv1p1 is implemented and MPAMF_MSMON_IDR.HAS_OFLW_MSI == 1. Otherwise, direct accesses to MSMON_OFLOW_MSI_MPAM are RES0.

[MSMON_OFLOW_MSI_ADDR_L](#), [MSMON_OFLOW_MSI_ADDR_H](#), [MSMON_OFLOW_MSI_ATTR](#), [MSMON_OFLOW_MSI_DATA](#), and [MSMON_OFLOW_MSI_MPAM](#) must all be implemented to support MSI writes for monitor overflow interrupts.

The power and reset domain of each MSC component is specific to that component.

Attributes

MSMON_OFLOW_MSI_MPAM is a 32-bit register.

Field descriptions

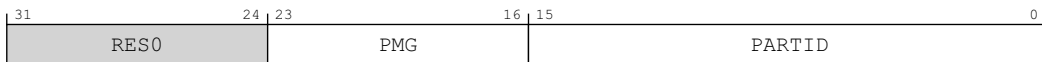

Bits [31:24]

Reserved, RES0.

PMG, bits [23:16]

Performance monitoring group property for an MSC monitor overflow MSI write.

The reset behavior of this field is:

- On a MSC reset, this field resets to an architecturally UNKNOWN value.

PARTID, bits [15:0]

Partition ID for an MSC monitor overflow MSI write.

The PARTID in this field is in the Secure PARTID space in the MSMON_OFLOW_MSI_MPAM_s instance and in the Non-secure PARTID space in the MSMON_OFLOW_MSI_MPAM_ns instance of this register.

The reset behavior of this field is:

- On a MSC reset, this field resets to an architecturally UNKNOWN value.

Accessing the MSMON_OFLOW_MSI_MPAM:

This register is within the MPAM feature page memory frames.

In a system that supports Secure, Non-secure, Root, and Realm memory maps, there must be MPAM feature pages in all four address maps:

- MSMON_OFLOW_MSI_MPAM_s must be accessible from the Secure MPAM feature page.
- MSMON_OFLOW_MSI_MPAM_ns must be accessible from the Non-secure MPAM feature page.
- MSMON_OFLOW_MSI_MPAM_rt must be accessible from the Root MPAM feature page.
- MSMON_OFLOW_MSI_MPAM_rl must be accessible from the Realm MPAM feature page.

MSMON_OFLOW_MSI_MPAM_s, MSMON_OFLOW_MSI_MPAM_ns, MSMON_OFLOW_MSI_MPAM_rt, and MSMON_OFLOW_MSI_MPAM_rl must be separate registers:

- The Secure instance (MSMON_OFLOW_MSI_MPAM_s) accesses the monitor overflow MSI MPAM information of Secure monitors.
- The Non-secure instance (MSMON_OFLOW_MSI_MPAM_ns) accesses the monitor overflow MSI MPAM information of Non-secure monitors.
- The Root instance (MSMON_OFLOW_MSI_MPAM_rt) accesses the monitor overflow MSI MPAM information of Root monitors.
- The Realm instance (MSMON_OFLOW_MSI_MPAM_rl) accesses the monitor overflow MSI MPAM information of Realm monitors.

MSMON_OFLOW_MSI_MPAM can be accessed through its memory-mapped interface:

Component	Frame	Offset	Instance
MPAM	MPAMF_BASE_s	0x08DC	MSMON_OFLOW_MSI_MPAM_s

Accesses to this interface are RW.

MSMON_OFLOW_MSI_MPAM can be accessed through its memory-mapped interface:

Component	Frame	Offset	Instance
MPAM	MPAMF_BASE_ns	0x08DC	MSMON_OFLOW_MSI_MPAM_ns

Accesses to this interface are RW.

MSMON_OFLOW_MSI_MPAM can be accessed through its memory-mapped interface:

Component	Frame	Offset	Instance
MPAM	MPAMF_BASE_rt	0x08DC	MSMON_OFLOW_MSI_MPAM_rt

When FEAT_RME is implemented, accesses to this interface are RW.

MSMON_OFLOW_MSI_MPAM can be accessed through its memory-mapped interface:

Component	Frame	Offset	Instance
MPAM	MPAMF_BASE_rl	0x08DC	MSMON_OFLOW_MSI_MPAM_rl

When FEAT_RME is implemented, accesses to this interface are RW.

11.5.20 MSMON_OFLOW_SR, MPAM Monitor Overflow Status Register

The MSMON_OFLOW_SR characteristics are:

Purpose

MSMON_OFLOW_SR is a 32-bit read-only register that shows MPAM monitor overflow status for this MSC.

MSMON_OFLOW_SR_s gives the status of overflows of Secure MPAM monitors.
 MSMON_OFLOW_SR_ns gives the status of overflows of Non-secure MPAM monitors.
 MSMON_OFLOW_SR_rt gives the status of overflows of Root MPAM monitors.
 MSMON_OFLOW_SR_rl gives the status of overflows of Realm MPAM monitors.

Configurations

The power domain of MSMON_OFLOW_SR is IMPLEMENTATION DEFINED.

This register is present only when MPAMF_MSMMON_IDR.HAS_OFLOW_SR == 1. Otherwise, direct accesses to MSMON_OFLOW_SR are RES0.

The power and reset domain of each MSC component is specific to that component.

Attributes

MSMON_OFLOW_SR is a 32-bit register.

Field descriptions

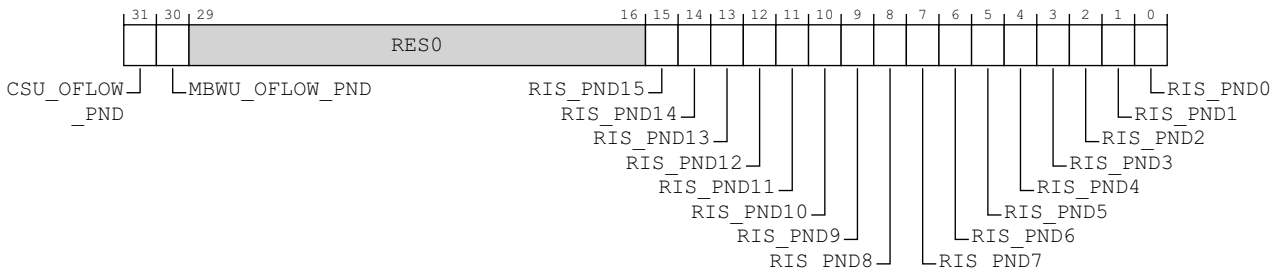

CSU_OFLOW_PND, bit [31]

At least one cache storage usage monitor has OFLOW_STATUS of 1 in [MSMON_CFG_CSU_CTL](#).

- 0b0 There are no cache storage usage monitor instances where [MSMON_CFG_CSU_CTL.OFLOW_STATUS](#) is 1.
- 0b1 [MSMON_CFG_CSU_CTL](#) for at least one of the cache storage usage monitor instances has OFLOW_STATUS set to 1.

This field clears when [MSMON_CFG_CSU_CTL.OFLOW_STATUS](#) has been reset to 0 for all CSU monitor instances in this MSC.

MBWU_OFLOW_PND, bit [30]

At least one memory bandwidth usage monitor instance has OFLOW_STATUS or OFLOW_STATUS_L of 1 in [MSMON_CFG_MBWU_CTL](#).

- 0b0 There are no memory bandwidth usage monitor instances where [MSMON_CFG_MBWU_CTL.OFLOW_STATUS](#) is 1.
- 0b1 [MSMON_CFG_MBWU_CTL](#) for at least one of the memory bandwidth usage monitor instances has either OFLOW_STATUS or OFLOW_STATUS_L set to 1.

This field clears when [MSMON_CFG_MBWU_CTL.OFLOW_STATUS](#) and [MSMON_CFG_MBWU_CTL.OFLOW_STATUS_L](#) have been reset to 0 for all MBWU monitor instances in this MSC.

Bits [29:16]

Reserved, RES0.

RIS_PND<r>, bit [r], for r = 15 to 0

Overflow status by RIS.

0b0 RIS r has no unread overflows of any type of monitor.

0b1 RIS r has at least one unread overflow in at least one of the monitor types.

Combined with the CSU_OFLOW_PND and MBWU_OFLOW_PND flags in this register, an interrupt service routine could poll only the monitor types indicated in monitors for the resource instances flagged in this field.

Bit r is set when any monitor instance of any type in resource instance r has OFLOW_STATUS or OFLOW_STATUS_L set to 1.

Accessing the MSMON_OFLOW_SR:

This register is within the MPAM feature page memory frames.

In a system that supports Secure, Non-secure, Root, and Realm memory maps, there must be MPAM feature pages in all four address maps:

- MSMON_OFLOW_SR_s must be accessible from the Secure MPAM feature page.
- MSMON_OFLOW_SR_ns must be accessible from the Non-secure MPAM feature page.
- MSMON_OFLOW_SR_rt must be accessible from the Root MPAM feature page.
- MSMON_OFLOW_SR_rl must be accessible from the Realm MPAM feature page.

MSMON_OFLOW_SR_s, MSMON_OFLOW_SR_ns, MSMON_OFLOW_SR_rt, and MSMON_OFLOW_SR_rl must be separate registers:

- The Secure instance (MSMON_OFLOW_SR_s) accesses the monitor overflow status summary of Secure monitors.
- The Non-secure instance (MSMON_OFLOW_SR_ns) accesses the monitor overflow status summary of Non-secure monitors.
- The Root instance (MSMON_OFLOW_SR_rt) accesses the monitor overflow status summary of Root monitors.
- The Realm instance (MSMON_OFLOW_SR_rl) accesses the monitor overflow status summary of Realm monitors.

MSMON_OFLOW_SR can be accessed through its memory-mapped interface:

Component	Frame	Offset	Instance
MPAM	MPAMF_BASE_s	0x08F0	MSMON_OFLOW_SR_s

Accesses to this interface are RO.

MSMON_OFLOW_SR can be accessed through its memory-mapped interface:

Component	Frame	Offset	Instance
MPAM	MPAMF_BASE_ns	0x08F0	MSMON_OFLOW_SR_ns

Accesses to this interface are RO.

MSMON_OFLOW_SR can be accessed through its memory-mapped interface:

Component	Frame	Offset	Instance
MPAM	MPAMF_BASE_rt	0x08F0	MSMON_OFLOW_SR_rt

When FEAT_RME is implemented, accesses to this interface are RO.

MSMON_OFLOW_SR can be accessed through its memory-mapped interface:

Component	Frame	Offset	Instance
MPAM	MPAMF_BASE_rl	0x08F0	MSMON_OFLOW_SR_rl

When FEAT_RME is implemented, accesses to this interface are RO.

11.6 Memory-mapped control and status registers

This section lists the external control and status registers.

11.6.1 MPAMF_ECR, MPAM Error Control Register

The MPAMF_ECR characteristics are:

Purpose

MPAMF_ECR is a 32-bit read/write register that controls MPAM error interrupts for this MSC. MPAMF_ECR_s controls Secure MPAM error handling. MPAMF_ECR_ns controls Non-secure MPAM error handling. MPAMF_ECR_rt controls Root MPAM error handling. MPAMF_ECR_rl controls Realm MPAM error handling.

Configurations

The power domain of MPAMF_ECR is IMPLEMENTATION DEFINED.

This register is present only when FEAT_MPAM is implemented. Otherwise, direct accesses to MPAMF_ECR are RES0.

If an MSC cannot encounter any of the error conditions listed in [Errors in MSCs](#), both the [MPAMF_ESR](#) and MPAMF_ECR must be RAZ/WI.

The power and reset domain of each MSC component is specific to that component.

Attributes

MPAMF_ECR is a 32-bit register.

Field descriptions

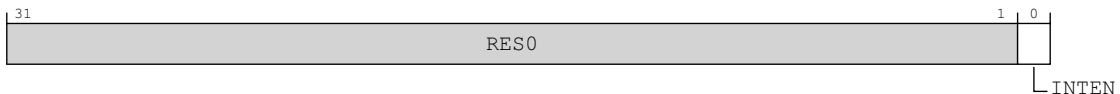

Bits [31:1]

Reserved, RES0.

INTEN, bit [0]

Interrupt Enable.

- 0b0 MPAM error interrupts are not signaled.
- 0b1 MPAM error interrupts are signaled.

Accessing the MPAMF_ECR:

This register is within the MPAM feature page memory frames.

In a system that supports Secure, Non-secure, Root, and Realm memory maps, there must be MPAM feature pages in all four address maps:

- MPAMF_ECR_s must be accessible from the Secure MPAM feature page.
- MPAMF_ECR_ns must be accessible from the Non-secure MPAM feature page.
- MPAMF_ECR_rt must be accessible from the Root MPAM feature page.
- MPAMF_ECR_rl must be accessible from the Realm MPAM feature page.

MPAMF_ECR_s, MPAMF_ECR_ns, MPAMF_ECR_rt, and MPAMF_ECR_rl must be separate registers:

- The Secure instance (MPAMF_ECR_s) accesses the error interrupt controls used for Secure PARTIDs.
- The Non-secure instance (MPAMF_ECR_ns) accesses the error interrupt controls used for Non-secure PARTIDs.

- The Root instance (MPAMF_ECR_rt) accesses the error interrupt controls used for Root PARTIDs.
- The Realm instance (MPAMF_ECR_rl) accesses the error interrupt controls used for Realm PARTIDs.

MPAMF_ECR can be accessed through its memory-mapped interface:

Component	Frame	Offset	Instance
MPAM	MPAMF_BASE_s	0x00F0	MPAMF_ECR_s

Accesses to this interface are RW.

MPAMF_ECR can be accessed through its memory-mapped interface:

Component	Frame	Offset	Instance
MPAM	MPAMF_BASE_ns	0x00F0	MPAMF_ECR_ns

Accesses to this interface are RW.

MPAMF_ECR can be accessed through its memory-mapped interface:

Component	Frame	Offset	Instance
MPAM	MPAMF_BASE_rt	0x00F0	MPAMF_ECR_rt

When FEAT_RME is implemented, accesses to this interface are RW.

MPAMF_ECR can be accessed through its memory-mapped interface:

Component	Frame	Offset	Instance
MPAM	MPAMF_BASE_rl	0x00F0	MPAMF_ECR_rl

When FEAT_RME is implemented, accesses to this interface are RW.

11.6.2 MPAMF_ERR_MSI_ADDR_H, MPAM Error MSI High-part Address Register

The MPAMF_ERR_MSI_ADDR_H characteristics are:

Purpose

MPAMF_ERR_MSI_ADDR_H is a 32-bit read/write register for the high part of the MPAM error MSI address.

MPAMF_ERR_MSI_ADDR_H_s is the high part of the MSI write address for error interrupts related to Secure PARTIDs. MPAMF_ERR_MSI_ADDR_H_ns is the high part of the MSI write address for error interrupts related to Non-secure PARTIDs. MPAMF_ERR_MSI_ADDR_H_rt is the high part of the MSI write address for error interrupts related to Root PARTIDs.

MPAMF_ERR_MSI_ADDR_H_rl is the high part of the MSI write address for error interrupts related to Realm PARTIDs.

Configurations

The power domain of MPAMF_ERR_MSI_ADDR_H is IMPLEMENTATION DEFINED.

This register is present only when MPAMF_IDR.HAS_ERR_MSI == 1. Otherwise, direct accesses to MPAMF_ERR_MSI_ADDR_H are RES0.

The power and reset domain of each MSC component is specific to that component.

Attributes

MPAMF_ERR_MSI_ADDR_H is a 32-bit register.

Field descriptions

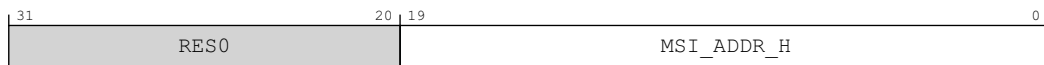

Bits [31:20]

Reserved, RES0.

MSI_ADDR_H, bits [19:0]

MSI write address bits[51:32].

Accessing the MPAMF_ERR_MSI_ADDR_H:

This register is within the MPAM feature page memory frames.

In a system that supports Secure, Non-secure, Root, and Realm memory maps, there must be MPAM feature pages in all four address maps:

- MPAMF_ERR_MSI_ADDR_H_s must be accessible from the Secure MPAM feature page.
- MPAMF_ERR_MSI_ADDR_H_ns must be accessible from the Non-secure MPAM feature page.
- MPAMF_ERR_MSI_ADDR_H_rt must be accessible from the Root MPAM feature page.
- MPAMF_ERR_MSI_ADDR_H_rl must be accessible from the Realm MPAM feature page.

MPAMF_ERR_MSI_ADDR_H_s, MPAMF_ERR_MSI_ADDR_H_ns, MPAMF_ERR_MSI_ADDR_H_rt, and MPAMF_ERR_MSI_ADDR_H_rl must be separate registers:

- The Secure instance (MPAMF_ERR_MSI_ADDR_H_s) accesses the high part of the memory address for MSI write to signal an MPAM error used for Secure PARTIDs.
- The Non-secure instance (MPAMF_ERR_MSI_ADDR_H_ns) accesses the high part of the memory address for MSI write to signal an MPAM error used for Non-secure PARTIDs.

- The Root instance (MPAMF_ERR_MSI_ADDR_H_rt) accesses the high part of the memory address for MSI write to signal an MPAM error used for Root PARTIDs.
- The Realm instance (MPAMF_ERR_MSI_ADDR_H_rl) accesses the high part of the memory address for MSI write to signal an MPAM error used for Realm PARTIDs.

MPAMF_ERR_MSI_ADDR_H can be accessed through its memory-mapped interface:

Component	Frame	Offset	Instance
MPAM	MPAMF_BASE_s	0x00E4	MPAMF_ERR_MSI_ADDR_H_s

Accesses to this interface are RW.

MPAMF_ERR_MSI_ADDR_H can be accessed through its memory-mapped interface:

Component	Frame	Offset	Instance
MPAM	MPAMF_BASE_ns	0x00E4	MPAMF_ERR_MSI_ADDR_H_ns

Accesses to this interface are RW.

MPAMF_ERR_MSI_ADDR_H can be accessed through its memory-mapped interface:

Component	Frame	Offset	Instance
MPAM	MPAMF_BASE_rt	0x00E4	MPAMF_ERR_MSI_ADDR_H_rt

When FEAT_RME is implemented, accesses to this interface are RW.

MPAMF_ERR_MSI_ADDR_H can be accessed through its memory-mapped interface:

Component	Frame	Offset	Instance
MPAM	MPAMF_BASE_rl	0x00E4	MPAMF_ERR_MSI_ADDR_H_rl

When FEAT_RME is implemented, accesses to this interface are RW.

11.6.3 MPAMF_ERR_MSI_ADDR_L, MPAM Error MSI Low-part Address Register

The MPAMF_ERR_MSI_ADDR_L characteristics are:

Purpose

MPAMF_ERR_MSI_ADDR_L is a 32-bit read/write register for the low part of the MPAM error MSI address.

MPAMF_ERR_MSI_ADDR_L_s is the low part of the MSI write address for error interrupts related to Secure PARTIDs. MPAMF_ERR_MSI_ADDR_L_ns is the low part of the MSI write address for error interrupts related to Non-secure PARTIDs. MPAMF_ERR_MSI_ADDR_L_rt is the low part of the MSI write address for error interrupts related to Root PARTIDs.

MPAMF_ERR_MSI_ADDR_L_rl is the low part of the MSI write address for error interrupts related to Realm PARTIDs.

Configurations

The power domain of MPAMF_ERR_MSI_ADDR_L is IMPLEMENTATION DEFINED.

This register is present only when MPAMF_IDR.HAS_ERR_MSI == 1. Otherwise, direct accesses to MPAMF_ERR_MSI_ADDR_L are RES0.

The power and reset domain of each MSC component is specific to that component.

Attributes

MPAMF_ERR_MSI_ADDR_L is a 32-bit register.

Field descriptions

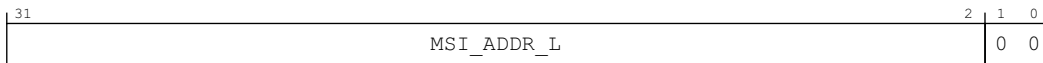

MSI_ADDR_L, bits [31:2]

MSI write address bits[31:2].

Bits [1:0]

Reads as 0b00.

Access to this field is RO.

Accessing the MPAMF_ERR_MSI_ADDR_L:

This register is within the MPAM feature page memory frames.

In a system that supports Secure, Non-secure, Root, and Realm memory maps, there must be MPAM feature pages in all four address maps:

- MPAMF_ERR_MSI_ADDR_L_s must be accessible from the Secure MPAM feature page.
- MPAMF_ERR_MSI_ADDR_L_ns must be accessible from the Non-secure MPAM feature page.
- MPAMF_ERR_MSI_ADDR_L_rt must be accessible from the Root MPAM feature page.
- MPAMF_ERR_MSI_ADDR_L_rl must be accessible from the Realm MPAM feature page.

MPAMF_ERR_MSI_ADDR_L_s, MPAMF_ERR_MSI_ADDR_L_ns, MPAMF_ERR_MSI_ADDR_L_rt, and MPAMF_ERR_MSI_ADDR_L_rl must be separate registers:

- The Secure instance (MPAMF_ERR_MSI_ADDR_L_s) accesses the low part of the memory address for MSI write to signal an MPAM error used for Secure PARTIDs.

- The Non-secure instance (MPAMF_ERR_MSI_ADDR_L_ns) accesses the low part of the memory address for MSI write to signal an MPAM error used for Non-secure PARTIDs.
- The Root instance (MPAMF_ERR_MSI_ADDR_L_rt) accesses the low part of the memory address for MSI write to signal an MPAM error used for Root PARTIDs.
- The Realm instance (MPAMF_ERR_MSI_ADDR_L_rl) accesses the low part of the memory address for MSI write to signal an MPAM error used for Realm PARTIDs.

MPAMF_ERR_MSI_ADDR_L can be accessed through its memory-mapped interface:

Component	Frame	Offset	Instance
MPAM	MPAMF_BASE_s	0x00E0	MPAMF_ERR_MSI_ADDR_L_s

Accesses to this interface are RW.

MPAMF_ERR_MSI_ADDR_L can be accessed through its memory-mapped interface:

Component	Frame	Offset	Instance
MPAM	MPAMF_BASE_ns	0x00E0	MPAMF_ERR_MSI_ADDR_L_ns

Accesses to this interface are RW.

MPAMF_ERR_MSI_ADDR_L can be accessed through its memory-mapped interface:

Component	Frame	Offset	Instance
MPAM	MPAMF_BASE_rt	0x00E0	MPAMF_ERR_MSI_ADDR_L_rt

When FEAT_RME is implemented, accesses to this interface are RW.

MPAMF_ERR_MSI_ADDR_L can be accessed through its memory-mapped interface:

Component	Frame	Offset	Instance
MPAM	MPAMF_BASE_rl	0x00E0	MPAMF_ERR_MSI_ADDR_L_rl

When FEAT_RME is implemented, accesses to this interface are RW.

11.6.4 MPAMF_ERR_MSI_ATTR, MPAM Error MSI Write Attributes Register

The MPAMF_ERR_MSI_ATTR characteristics are:

Purpose

MPAMF_ERR_MSI_ATTR is a 32-bit read/write register that controls MPAM error MSI write attributes for MPAM errors in this MSC.

MPAMF_ERR_MSI_ATTR_s controls the attributes of Secure MPAM error MSI writes.

MPAMF_ERR_MSI_ATTR_ns controls the attributes of Non-secure MPAM error MSI writes.

MPAMF_ERR_MSI_ATTR_rt controls the attributes of Root MPAM error MSI writes.

MPAMF_ERR_MSI_ATTR_rl controls the attributes of Realm MPAM error MSI writes.

Configurations

The power domain of MPAMF_ERR_MSI_ATTR is IMPLEMENTATION DEFINED.

This register is present only when MPAMF_IDR.HAS_ERR_MSI == 1. Otherwise, direct accesses to MPAMF_ERR_MSI_ATTR are RES0.

The power and reset domain of each MSC component is specific to that component.

Attributes

MPAMF_ERR_MSI_ATTR is a 32-bit register.

Field descriptions

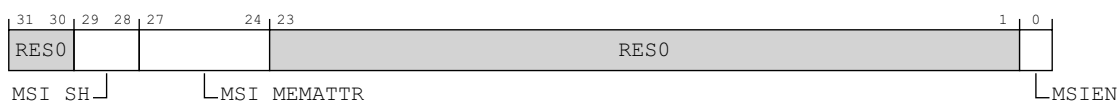

Bits [31:30]

Reserved, RES0.

MSI_SH, bits [29:28]

Sharability attribute of MSI writes.

0b00 Non-shareable.

0b01 Reserved, CONSTRAINED UNPREDICTABLE.

0b10 Outer Shareable.

0b11 Inner Shareable.

When MPAMF_ERR_MSI_ATTR.MSI_MEMATTR specifies a Device memory type, the contents of this field are IGNORED and Shareability is effectively Outer Shareable.

MSI_MEMATTR, bits [27:24]

Memory attributes of MSI writes.

Note: This encoding matches the VMSAv8-64 stage 2 MemAttr[3:0] field as described in the Arm ARM, except that the following encodings are Reserved (not UNPREDICTABLE) and behave as Device-nGnRnE: 0b0100, 0b1000, and 0b1100.

0b0000 Device-nGnRnE.

0b0001 Device-nGnRE.

0b0010 Device-nGRE.

0b0011 Device-GRE.

0b0100 Reserved. Behave as Device-nGnRnE, 0b0000.

0b0101 Normal Inner Non-cacheable, Outer Non-cacheable.

0b0110	Normal Inner Write-Through Cacheable, Outer Non-cacheable.
0b0111	Normal Inner Write-Back Cacheable, Outer Non-cacheable.
0b1000	Reserved. Behave as Device-nGnRnE, 0b0000.
0b1001	Normal Inner Non-Cachable, Outer Write-Through Cacheable.
0b1010	Normal Inner Write-Through Cacheable, Outer Write-Through Cacheable.
0b1011	Normal Inner Write-Back Cacheable, Outer Write-Through Cacheable.
0b1100	Reserved. Behave as Device-nGnRnE, 0b0000.
0b1101	Normal Inner Non-cacheable, Outer Write-Back Cacheable.
0b1110	Normal Inner Write-Through Cacheable, Outer Write-Back Cacheable.
0b1111	Normal Inner Write-Back Cacheable, Outer Write-Back Cacheable.

When this field specifies a Device memory type, the contents of MPAMF_ERR_MSI_ATTR.MSI_SH are IGNORED and Shareability is effectively Outer Shareable.

Device types may be implemented as any Device type with more than 'n' characters. For example, if this field is set to 0b0010, an implementation may treat the MSI write as the specified type, Device-nGRE, or as Device-nGnRE or as Device-nGnRnE.

Reserved encodings 0b0100, 0b1000, and 0b1100 must be implemented to behave the same as the 0b0000 encoding.

Bits [23:1]

Reserved, RES0.

MSIEN, bit [0]

Error interrupt MSI Enable.

- | | |
|-----|---|
| 0b0 | MPAM error MSI writes are not generated to signal enabled MPAM error interrupts. When error MSI writes are disabled, hardwired error interrupts could be generated. |
| 0b1 | MPAM error MSI writes are generated to signal enabled MPAM error interrupts. When error MSI writes are enabled, hardwired error interrupts are not generated. |

The value of this field affects whether hardwired error interrupts are generated.

The reset behavior of this field is:

- On a MSC reset, this field resets to 0.

Accessing the MPAMF_ERR_MSI_ATTR:

This register is within the MPAM feature page memory frames.

In a system that supports Secure, Non-secure, Root, and Realm memory maps, there must be MPAM feature pages in all four address maps:

- MPAMF_ERR_MSI_ATTR_s must be accessible from the Secure MPAM feature page.
- MPAMF_ERR_MSI_ATTR_ns must be accessible from the Non-secure MPAM feature page.
- MPAMF_ERR_MSI_ATTR_rt must be accessible from the Root MPAM feature page.
- MPAMF_ERR_MSI_ATTR_rl must be accessible from the Realm MPAM feature page.

MPAMF_ERR_MSI_ATTR_s, MPAMF_ERR_MSI_ATTR_ns, MPAMF_ERR_MSI_ATTR_rt, and MPAMF_ERR_MSI_ATTR_rl must be separate registers:

- The Secure instance (MPAMF_ERR_MSI_ATTR_s) accesses the memory access attributes for MSI write to signal an MPAM error used for Secure PARTIDs.
- The Non-secure instance (MPAMF_ERR_MSI_ATTR_ns) accesses the memory access attributes for MSI write to signal an MPAM error used for Non-secure PARTIDs.

- The Root instance (MPAMF_ERR_MSI_ATTR_rt) accesses the memory access attributes for MSI write to signal an MPAM error used for Root PARTIDs.
- The Realm instance (MPAMF_ERR_MSI_ATTR_rl) accesses the memory access attributes for MSI write to signal an MPAM error used for Realm PARTIDs.

MPAMF_ERR_MSI_ATTR can be accessed through its memory-mapped interface:

Component	Frame	Offset	Instance
MPAM	MPAMF_BASE_s	0x00EC	MPAMF_ERR_MSI_ATTR_s

Accesses to this interface are RW.

MPAMF_ERR_MSI_ATTR can be accessed through its memory-mapped interface:

Component	Frame	Offset	Instance
MPAM	MPAMF_BASE_ns	0x00EC	MPAMF_ERR_MSI_ATTR_ns

Accesses to this interface are RW.

MPAMF_ERR_MSI_ATTR can be accessed through its memory-mapped interface:

Component	Frame	Offset	Instance
MPAM	MPAMF_BASE_rt	0x00EC	MPAMF_ERR_MSI_ATTR_rt

When FEAT_RME is implemented, accesses to this interface are RW.

MPAMF_ERR_MSI_ATTR can be accessed through its memory-mapped interface:

Component	Frame	Offset	Instance
MPAM	MPAMF_BASE_rl	0x00EC	MPAMF_ERR_MSI_ATTR_rl

When FEAT_RME is implemented, accesses to this interface are RW.

11.6.5 MPAMF_ERR_MSI_DATA, MPAM Error MSI Data Register

The MPAMF_ERR_MSI_DATA characteristics are:

Purpose

MPAMF_ERR_MSI_DATA is a 32-bit read/write register for the MPAM error MSI data.

MPAMF_ERR_MSI_DATA_s is the data for the MSI write for error interrupts related to Secure PARTIDs. MPAMF_ERR_MSI_DATA_ns is the data for the MSI write for error interrupts related to Non-secure PARTIDs. MPAMF_ERR_MSI_DATA_rt is the data for the MSI write for error interrupts related to Root PARTIDs. MPAMF_ERR_MSI_DATA_rl is the data for the MSI write for error interrupts related to Realm PARTIDs.

Configurations

The power domain of MPAMF_ERR_MSI_DATA is IMPLEMENTATION DEFINED.

This register is present only when MPAMF_IDR.HAS_ERR_MSI == 1. Otherwise, direct accesses to MPAMF_ERR_MSI_DATA are RES0.

The power and reset domain of each MSC component is specific to that component.

Attributes

MPAMF_ERR_MSI_DATA is a 32-bit register.

Field descriptions

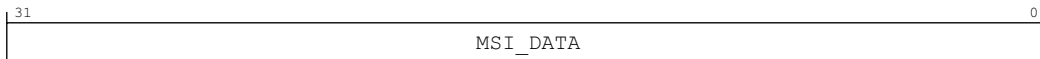

MSI_DATA, bits [31:0]

MSI data to be written to ITS to signal an MSI.

Accessing the MPAMF_ERR_MSI_DATA:

This register is within the MPAM feature page memory frames.

In a system that supports Secure, Non-secure, Root, and Realm memory maps, there must be MPAM feature pages in all four address maps:

- MPAMF_ERR_MSI_DATA_s must be accessible from the Secure MPAM feature page.
- MPAMF_ERR_MSI_DATA_ns must be accessible from the Non-secure MPAM feature page.
- MPAMF_ERR_MSI_DATA_rt must be accessible from the Root MPAM feature page.
- MPAMF_ERR_MSI_DATA_rl must be accessible from the Realm MPAM feature page.

MPAMF_ERR_MSI_DATA_s, MPAMF_ERR_MSI_DATA_ns, MPAMF_ERR_MSI_DATA_rt, and MPAMF_ERR_MSI_DATA_rl must be separate registers:

- The Secure instance (MPAMF_ERR_MSI_DATA_s) accesses the data for MSI write to signal an MPAM error used for Secure PARTIDs.
- The Non-secure instance (MPAMF_ERR_MSI_DATA_ns) accesses the data for MSI write to signal an MPAM error used for Non-secure PARTIDs.
- The Root instance (MPAMF_ERR_MSI_DATA_rt) accesses the data for MSI write to signal an MPAM error used for Root PARTIDs.
- The Realm instance (MPAMF_ERR_MSI_DATA_rl) accesses the data for MSI write to signal an MPAM error used for Realm PARTIDs.

MPAMF_ERR_MSI_DATA can be accessed through its memory-mapped interface:

Component	Frame	Offset	Instance
MPAM	MPAMF_BASE_s	0x00E8	MPAMF_ERR_MSI_DATA_s

Accesses to this interface are RW.

MPAMF_ERR_MSI_DATA can be accessed through its memory-mapped interface:

Component	Frame	Offset	Instance
MPAM	MPAMF_BASE_ns	0x00E8	MPAMF_ERR_MSI_DATA_ns

Accesses to this interface are RW.

MPAMF_ERR_MSI_DATA can be accessed through its memory-mapped interface:

Component	Frame	Offset	Instance
MPAM	MPAMF_BASE_rt	0x00E8	MPAMF_ERR_MSI_DATA_rt

When FEAT_RME is implemented, accesses to this interface are RW.

MPAMF_ERR_MSI_DATA can be accessed through its memory-mapped interface:

Component	Frame	Offset	Instance
MPAM	MPAMF_BASE_rl	0x00E8	MPAMF_ERR_MSI_DATA_rl

When FEAT_RME is implemented, accesses to this interface are RW.

11.6.6 MPAMF_ERR_MSI_MPAM, MPAM Error MSI Write MPAM Information Register

The MPAMF_ERR_MSI_MPAM characteristics are:

Purpose

MPAMF_ERR_MSI_MPAM is a 32-bit read/write register that sets the MPAM information for error MSI write attributes for MPAM errors in this MSC.

MPAMF_ERR_MSI_MPAM_s controls MPAM information labeling of Secure MPAM error MSI writes. MPAMF_ERR_MSI_MPAM_ns controls MPAM information labeling of Non-secure MPAM error MSI writes. MPAMF_ERR_MSI_MPAM_rt controls MPAM information labeling of Root MPAM error MSI writes. MPAMF_ERR_MSI_MPAM_rl controls MPAM information labeling of Realm MPAM error MSI writes.

Configurations

The power domain of MPAMF_ERR_MSI_MPAM is IMPLEMENTATION DEFINED.

This register is present only when MPAMF_IDR.HAS_ERR_MSI == 1. Otherwise, direct accesses to MPAMF_ERR_MSI_MPAM are RES0.

The power and reset domain of each MSC component is specific to that component.

Attributes

MPAMF_ERR_MSI_MPAM is a 32-bit register.

Field descriptions



Bits [31:24]

Reserved, RES0.

PMG, bits [23:16]

Performance monitoring group property for PARTID MSC error interrupt write.

The reset behavior of this field is:

- On a MSC reset, this field resets to an architecturally UNKNOWN value.

PARTID, bits [15:0]

Partition ID for MSC error interrupt write.

The PARTID in this register is in the Secure PARTID space in the MPAMF_ERR_MSI_MPAM_s instance and in the Non-secure PARTID space in the MPAMF_ERR_MSI_MPAM_ns instance of this register.

The reset behavior of this field is:

- On a MSC reset, this field resets to an architecturally UNKNOWN value.

Accessing the MPAMF_ERR_MSI_MPAM:

This register is within the MPAM feature page memory frames.

In a system that supports Secure, Non-secure, Root, and Realm memory maps, there must be MPAM feature pages in all four address maps:

- MPAMF_ERR_MSI_MPAM_s must be accessible from the Secure MPAM feature page.
- MPAMF_ERR_MSI_MPAM_ns must be accessible from the Non-secure MPAM feature page.

- MPAMF_ERR_MSI_MPAM_rt must be accessible from the Root MPAM feature page.
- MPAMF_ERR_MSI_MPAM_rl must be accessible from the Realm MPAM feature page.

MPAMF_ERR_MSI_MPAM_s, MPAMF_ERR_MSI_MPAM_ns, MPAMF_ERR_MSI_MPAM_rt, and MPAMF_ERR_MSI_MPAM_rl must be separate registers:

- The Secure instance (MPAMF_ERR_MSI_MPAM_s) accesses the MPAM information for MSI write request to signal an MPAM error used for Secure PARTIDs.
- The Non-secure instance (MPAMF_ERR_MSI_MPAM_ns) accesses the MPAM information for MSI write request to signal an MPAM error used for Non-secure PARTIDs.
- The Root instance (MPAMF_ERR_MSI_MPAM_rt) accesses the MPAM information for MSI write request to signal an MPAM error used for Root PARTIDs.
- The Realm instance (MPAMF_ERR_MSI_MPAM_rl) accesses the MPAM information for MSI write request to signal an MPAM error used for Realm PARTIDs.

MPAMF_ERR_MSI_MPAM can be accessed through its memory-mapped interface:

Component	Frame	Offset	Instance
MPAM	MPAMF_BASE_s	0x00DC	MPAMF_ERR_MSI_MPAM_s

Accesses to this interface are RW.

MPAMF_ERR_MSI_MPAM can be accessed through its memory-mapped interface:

Component	Frame	Offset	Instance
MPAM	MPAMF_BASE_ns	0x00DC	MPAMF_ERR_MSI_MPAM_ns

Accesses to this interface are RW.

MPAMF_ERR_MSI_MPAM can be accessed through its memory-mapped interface:

Component	Frame	Offset	Instance
MPAM	MPAMF_BASE_rt	0x00DC	MPAMF_ERR_MSI_MPAM_rt

When FEAT_RME is implemented, accesses to this interface are RW.

MPAMF_ERR_MSI_MPAM can be accessed through its memory-mapped interface:

Component	Frame	Offset	Instance
MPAM	MPAMF_BASE_rl	0x00DC	MPAMF_ERR_MSI_MPAM_rl

When FEAT_RME is implemented, accesses to this interface are RW.

11.6.7 MPAMF_ESR, MPAM Error Status Register

The MPAMF_ESR characteristics are:

Purpose

Indicates MPAM error status for this MSC.

MPAMF_ESR_s reports Secure MPAM errors. MPAMF_ESR_ns reports Non-secure MPAM errors. MPAMF_ESR_rt reports Root MPAM errors. MPAMF_ESR_rl reports Realm MPAM errors.

Software should write this register after reading the status of an error to reset ERRCODE to 0x0000 and OVRWR to 0 so that future errors are not reported with OVRWR set.

Configurations

The power domain of MPAMF_ESR is IMPLEMENTATION DEFINED.

This register is present only when FEAT_MPAM is implemented. Otherwise, direct accesses to MPAMF_ESR are RES0.

MPAMF_ESR is 64-bit register when MPAM v0.1 or v1.1 is implemented and MPAMF_IDR.HAS_EXTD_ESR == 1.

Otherwise, MPAMF_ESR is a 32-bit register.

If an MSC cannot encounter any of the error conditions listed in [Errors in MSCs](#), both the MPAMF_ESR and MPAMF_ECR must be RAZ/WI.

The power and reset domain of each MSC component is specific to that component.

Attributes

MPAMF_ESR is a:

- 64-bit register when (FEAT_MPAMv0p1 is implemented or FEAT_MPAMv1p1 is implemented) and MPAMF_IDR.HAS_EXTD_ESR == 1
- 32-bit register otherwise

Field descriptions

When (FEAT_MPAMv0p1 is implemented or FEAT_MPAMv1p1 is implemented) and MPAMF_IDR.HAS_EXTD_ESR == 1:

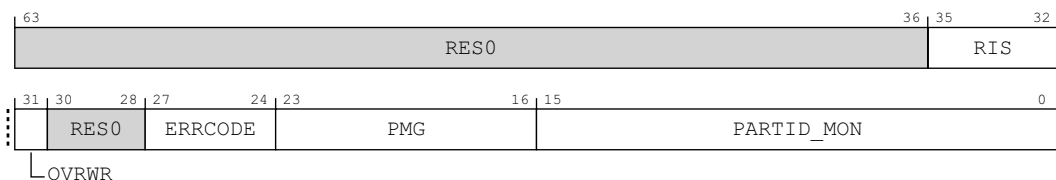

Bits [63:36]

Reserved, RES0.

RIS, bits [35:32]

When MPAMF_IDR.HAS_RIS == 1:

Resource Instance Selector. Where applicable to the ERRCODE, captures the RIS value for the error.

Otherwise:

Reserved, RES0.

OVRWR, bit [31]

Overwritten.

If 0 and ERRCODE == 0b0000, no errors have occurred.

If 0 and ERRCODE is non-zero, a single error has occurred and is recorded in this register.

If 1 and ERRCODE is non-zero, multiple errors have occurred and this register records the most recent error.

The state where this bit is 1 and ERRCODE is zero must not be produced by hardware and is only reached when software writes this combination into this register.

Bits [30:28]

Reserved, RES0.

ERRCODE, bits [27:24]

Error code.

- 0b0000 No error.
- 0b0001 PARTID_SEL_Range.
- 0b0010 Req_PARTID_Range.
- 0b0011 MSMONCFG_ID_RANGE.
- 0b0100 Req_PMG_Range.
- 0b0101 Monitor_Range.
- 0b0110 intPARTID_Range.
- 0b0111 Unexpected_INTERNAL.
- 0b1000 Undefined_RIS_PART_SEL.
- 0b1001 RIS_No_Control.
- 0b1010 Undefined_RIS_MON_SEL.
- 0b1011 RIS_No_Monitor.
- 0b1100 Reserved.
- 0b1101 Reserved.
- 0b1110 Reserved.
- 0b1111 Reserved.

PMG, bits [23:16]

Program monitoring group.

Set to the PMG on an error that captures PMG. Otherwise, set to 0x00 on an error that does not capture PMG.

PARTID_MON, bits [15:0]

PARTID or monitor.

Set to the PARTID on an error that captures PARTID.

Set to the monitor index on an error that captures MON.

On an error that captures neither PARTID nor MON, this field is set to 0.

Otherwise:

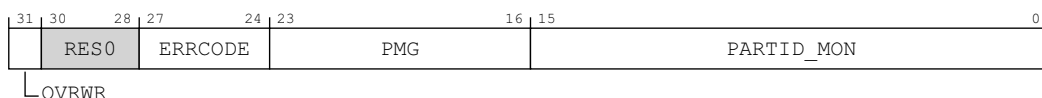

OVRWR, bit [31]

Overwritten.

If 0 and ERRCODE == 0b0000, no errors have occurred.

If 0 and ERRCODE is non-zero, a single error has occurred and is recorded in this register.

If 1 and ERRCODE is non-zero, multiple errors have occurred and this register records the most recent error.

The state where this bit is 1 and ERRCODE is 0 must not be produced by hardware and is only reached when software writes this combination into this register.

Bits [30:28]

Reserved, RES0.

ERRCODE, bits [27:24]

Error code.

0b0000	No error.
0b0001	PARTID_SEL_Range.
0b0010	Req_PARTID_Range.
0b0011	MSMONCFG_ID_RANGE.
0b0100	Req_PMG_Range.
0b0101	Monitor_Range.
0b0110	intPARTID_Range.
0b0111	Unexpected_INTERNAL.
0b1000	Reserved.
0b1001	Reserved.
0b1010	Reserved.
0b1011	Reserved.
0b1100	Reserved.
0b1101	Reserved.
0b1110	Reserved.
0b1111	Reserved.

PMG, bits [23:16]

Program monitoring group.

Set to the PMG on an error that captures PMG. Otherwise, set to 0x00 on an error that does not capture PMG.

PARTID_MON, bits [15:0]

PARTID or monitor.

Set to the PARTID on an error that captures PARTID.

Set to the monitor index on an error that captures MON.

On an error that captures neither PARTID nor MON, this field is set to 0x0000.

Accessing the MPAMF_ESR:

This register is within the MPAM feature page memory frames.

In a system that supports Secure, Non-secure, Root, and Realm memory maps, there must be MPAM feature pages in all four address maps:

- MPAMF_ESR_s must be accessible from the Secure MPAM feature page.

- MPAMF_ESR_ns must be accessible from the Non-secure MPAM feature page.
- MPAMF_ESR_rt must be accessible from the Root MPAM feature page.
- MPAMF_ESR_rl must be accessible from the Realm MPAM feature page.

MPAMF_ESR_s, MPAMF_ESR_ns, MPAMF_ESR_rt, and MPAMF_ESR_rl must be separate registers:

- The Secure instance (MPAMF_ESR_s) accesses the error status used for Secure PARTIDs.
- The Non-secure instance (MPAMF_ESR_ns) accesses the error status used for Non-secure PARTIDs.
- The Root instance (MPAMF_ESR_rt) accesses the error status used for Root PARTIDs.
- The Realm instance (MPAMF_ESR_rl) accesses the error status used for Realm PARTIDs.

MPAMF_ESR can be accessed through its memory-mapped interface:

Component	Frame	Offset	Instance
MPAM	MPAMF_BASE_s	0x00F8	MPAMF_ESR_s

Accesses to this interface are RW.

MPAMF_ESR can be accessed through its memory-mapped interface:

Component	Frame	Offset	Instance
MPAM	MPAMF_BASE_ns	0x00F8	MPAMF_ESR_ns

Accesses to this interface are RW.

MPAMF_ESR can be accessed through its memory-mapped interface:

Component	Frame	Offset	Instance
MPAM	MPAMF_BASE_rt	0x00F8	MPAMF_ESR_rt

When FEAT_RME is implemented, accesses to this interface are RW.

MPAMF_ESR can be accessed through its memory-mapped interface:

Component	Frame	Offset	Instance
MPAM	MPAMF_BASE_rl	0x00F8	MPAMF_ESR_rl

When FEAT_RME is implemented, accesses to this interface are RW.

Chapter 12

Errors in MSCs

This chapter contains the following sections:

- *Introduction* on page 12-392.
- *Error conditions in accessing memory-mapped registers* on page 12-393.
- *Overwritten error status* on page 12-397.
- *Behavior of configuration reads and writes with errors* on page 12-398.
- *Optionality of error detection and reporting* on page 12-403.

12.1 Introduction

When an MSC detects an error on an access to a memory-mapped register, information about the error must be captured in the MPAMF_ESR register and signaled to software via an interrupt. The errors covered by this mechanism could be caused by software errors.

Errors, whether detected or not, must not prevent the handling of the request by the MSC, but errors can cause the MSC to use different MPAM resource control settings than expected or cause monitors to mis-attribute monitored events. See [Optionality of error detection and reporting on page 12-403](#).

———— **Note** —————

Implementation choices in an MSC may make certain errors impossible. For example, if the request interface only implements enough bits to exactly cover the range of 0 to PARTID_MAX and does not detect whether the unimplemented high-order bits of the PARTID are all zero, then the request PARTID cannot be detected as out-of-range, so ERRCODE == 2 could not occur.

MPAM errors that an implementation detects are recorded in MPAMF_ESR_s or MPAMF_ESR_ns. The error condition descriptions in [Error conditions in accessing memory-mapped registers on page 12-393](#) describe whether the Security state of the PARTID or of the request address are used to determine which instance of MPAMF_ESR records the error status.

MSCs signal errors in accesses to memory-mapped registers using an error interrupt. See [MPAM Error Interrupt on page 8-175](#). Errors recorded in MPAMF_ESR_s signal a Secure MPAM error interrupt if enabled by MPAMF_ECR_s.INTEN == 1. Errors recorded in MPAMF_ESR_ns signal a Non-secure MPAM error interrupt if enabled by MPAMF_ECR_ns.INTEN.

The MPAMF_ESR in an MSC captures the reason for an error, so that it can be accurately reported to software.

When [Resource instance selection](#) is implemented, hardware is permitted to make choices regarding CONSTRAINED UNPREDICTABLE behaviors and unimplemented RIS bits that could reduce or remove the need to detect or report any of the RIS-related errors. For more information on RIS, see [Resource instance selection on page 8-166](#).

12.2 Error conditions in accessing memory-mapped registers

When an MSC detects an error condition, information about the error is captured in [MPAMF_ESR](#). [MPAMF_ESR.ERRCODE](#) encodes the reason for the error as shown in [Table 12-1](#). Other fields are captured in [MPAMF_ESR](#) as shown in the “Fields Captured” column of [Table 12-1](#).

Table 12-1 Error conditions in accessing memory-mapped registers

MPAM Error Code (ERRCODE)	Error Name	Error Description	Fields Captured
0	No Error	No error captured in MPAMF_ESR .	None
1	PARTID_SEL_Range	MPAMCFG_PART_SEL stored with an out-of-range PARTID.	PARTID and RIS ^a
2	Req_PARTID_Range	A request has out-of-range PARTID.	PARTID, PMG
3	MSMONCFG_ID_RANGE	MSMON configuration request has out-of-range PARTID or PMG.	PARTID, PMG, RIS ^a
4	Req_PMG_Range	A request has out-of-range PMG.	PARTID and PMG
5	Monitor_Range	MSMON_CFG_MON_SEL has out-of-range monitor selector.	MON_SEL, RIS ^a
6	intPARTID_Range	The intPARTID in MPAMCFG_INTPARTID is out of the intPARTID range for the PARTID in MPAMCFG_PART_SEL .	intPARTID
7	Unexpected_INTERNAL	MPAMCFG_PART_SEL.INTERNAL is set when a reqPARTID is expected.	PARTID
8	Undefined_RIS_PART_SEL	Unimplemented RIS in MPAMCFG_PART_SEL.RIS .	PART_SEL, RIS
9	RIS_No_Control	Resource instance selected by MPAMCFG_PART_SEL.RIS does not have the accessed partitioning control.	PART_SEL, RIS
10	Undefined_RIS_MON_SEL	Unimplemented RIS in MSMON_CFG_MON_SEL .	MON_SEL, RIS
11	RIS_No_Monitor	Resource instance selected by MSMON_CFG_MON_SEL.RIS does not have the accessed monitor type.	MON_SEL, RIS
12:18	Reserved	Reserved for future use.	--

a. This field is only available when [MPAMF_IDR.EXT](#) and [MPAMF_IDR.HAS_RIS](#) are 1.

12.2.1 No error (errorcode == 0)

No error is captured in [MPAMF_ESR](#).

12.2.2 PARTID_SEL out-of-range error (errorcode == 1)

The value of the [MPAMCFG_PART_SEL.PARTID_SEL](#) field is out-of-range for the PARTID space selected by the NS bit on a store to an MPAMCFG memory-mapped register.

The selection of the Secure or Non-secure version of [MPAMF_ESR](#) for capturing the error information is also controlled by the NS bit.

12.2.3 Request PARTID out-of-range error (errorcode == 2)

The value of PARTID in a request is out-of-range for the MSC's MPAM implementation of PARTID space selected by the MPAM_NS bit.

The selection of the Secure or Non-secure version of [MPAMF_ESR](#) for capturing the error information is also controlled by the MPAM_NS bit.

The MPAM behavior of an MSC for a request that causes this error is CONSTRAINED UNPREDICTABLE:

- The request may be processed as if the PARTID is any valid PARTID in the same MPAM Security state (MPAM_NS) as the request's PARTID.
- Arm recommends that the default PARTID for the MPAM_NS Security state is used. See [Default PARTID on page 3-40](#).

12.2.4 MSMON configuration ID out-of-range error (errorcode == 3)

A write to configure a monitor contains an out-of-range value for either the PARTID or PMG for the PARTID space selected by the Secure address space bit, NS.

The selection of the Secure or Non-secure version of [MPAMF_ESR](#) for capturing the error information is also controlled by the NS bit.

12.2.5 Request PMG out-of-range error (errorcode == 4)

The value of PMG in a request is out of range for the MSC's MPAM implementation of the PMG space selected by the MPAM security space bit, MPAM_NS.

The selection of the Secure or Non-secure version of [MPAMF_ESR](#) for capturing the error information is also controlled by the MPAM_NS bit.

The MPAM behavior of an MSC for a request that causes this error is CONSTRAINED UNPREDICTABLE:

- The request may be processed as if the PARTID and PMG are any valid PARTID and PMG in the same MPAM Security state as the request.
 - Arm recommends that the request be processed as if the PMG is the default. See [Default PARTID on page 3-40](#).
- The default PARTID and PMG may be used for the request's MPAM_NS Security state. See [Default PARTID on page 3-40](#). The request may be IGNORED for performance monitoring, as if the PMG value does not match the monitor's PMG filter even if the PARTID matches.

12.2.6 Monitor out-of-range error (errorcode == 5)

The value of the monitor selector register, [MSMON_CFG_MON_SEL.MON_SEL](#), is out of range on a store to an [MSMON_*](#) memory-mapped register selected by the Secure address space bit, NS.

The selection of the Secure or Non-secure version of [MPAMF_ESR](#) for capturing the error information is also controlled by the NS bit.

12.2.7 intPARTID out-of-range error (errorcode == 6)

This error can only occur if PARTID narrowing is implemented. [MPAMF_IDR.HAS_PARTID_NRW == 1](#) indicates that an implementation has PARTID narrowing.

The selection of the Secure or Non-secure version of [MPAMF_ESR](#) for capturing the error information is controlled by the Secure address space bit, NS.

These conditions cause this error:

- [MPAMCFG_INTPARTID](#).INTPARTID is out-of-range for the intPARTID space selected by the Secure address space bit, NS, on a store to a memory-mapped register to configure the association of reqPARTID to intPARTID.
- [MPAMCFG_INTPARTIDINTERNAL](#) == 0 on any write to configure [MPAMCFG_INTPARTID](#).
- [MPAMCFG_PART_SEL](#).INTERNAL is not set when an intPARTID is expected. These expected cases include a read or write to any [MPAMCFG_*](#) register, other than [MPAMCFG_INTPARTID](#).

12.2.8 Unexpected INTERNAL error (errorcode == 7)

This error can only occur if PARTID narrowing is implemented. [MPAMF_IDR](#).HAS_PARTID_NRW == 1 indicates that an implementation has PARTID narrowing.

If PARTID narrowing is implemented in the MSC, this error is detected if the [MPAMCFG_PART_SEL](#).INTERNAL bit is set when a reqPARTID is expected. When PARTID narrowing is implemented, the only cases in which a reqPARTID is expected in [MPAMCFG_PART_SEL](#) are a read or write access to [MPAMCFG_INTPARTID](#).

The selection of the Secure or Non-secure version of [MPAMF_ESR](#) for capturing the error information is controlled by the Secure address space bit, NS.

Reads that cause this error return an UNKNOWN value.

12.2.9 Undefined RIS in [MPAMCFG_PART_SEL](#).RIS (errorcode == 8)

This error occurs when an access to an [MPAMCFG_*](#) register occurs when [MPAMCFG_PART_SEL](#).RIS does not correspond to a RIS value allocated to an MPAM resource of the MSC. The MPAM behavior of an MSC for a request that causes this error is a CONSTRAINED UNPREDICTABLE choice between:

- RAZ/WI.
- RAZ/WI and record an MPAM error in the [MPAMF_ESR](#) associated with that MSC, using the error code `ERRCODE == 8` and capturing [MPAMCFG_PART_SEL](#).{RIS, PARTID_SEL}.

12.2.10 RIS in [MPAMCFG_PART_SEL](#).RIS does not have partitioning control (errorcode == 9)

This error occurs when an access to an [MPAMCFG_*](#) register occurs when [MPAMCFG_PART_SEL](#).RIS selects a resource that exists but does not have the partitioning control accessed. The MPAM behavior of an MSC for a request that causes this error is a CONSTRAINED UNPREDICTABLE choice between:

- RAZ/WI.
- RAZ/WI and record an MPAM error in the [MPAMF_ESR](#) associated with that MSC, using the error code `ERRCODE == 9` and capturing [MPAMCFG_PART_SEL](#).{RIS, PARTID_SEL}.

12.2.11 Undefined RIS in [MSMON_CFG_MON_SEL](#).RIS (errorcode == 10)

This error occurs when an access to an [MSMON_CFG_*](#) register occurs when [MSMON_CFG_MON_SEL](#).RIS does not correspond to an MPAM resource of the MSC. The MPAM behavior of an MSC for a request that causes this error is a CONSTRAINED UNPREDICTABLE choice between:

- RAZ/WI.
- RAZ/WI and record an MPAM error in the [MPAMF_ESR](#) associated with that MSC, using the error code `ERRCODE == 10` and capturing [MSMON_CFG_MON_SEL](#).{RIS, MON_SEL}.

12.2.12 RIS selected by MSMON_CFG_MON_SEL.RIS does not have monitor type (errorcode == 11)

Access to an MSMON_<type> or MSMON_<type>_CAPTURE register when MSMON_CFG_MON_SEL.RIS does not correspond to an MPAM resource of the MSC or that does not have the type of monitor accessed by the MSMON_<type> or MSMON_<type>_CAPTURE register. The MPAM behavior of an MSC for a request that causes this error is a CONSTRAINED UNPREDICTABLE choice between:

- Read as 0xFFFFFFFF, NRDY == 1 with value of 0x7FFFFFFE, and WI. This value is highly unlikely as a normal return value in any monitor.
- RAZ/WI.
- RAZ/WI and record an MPAM error in the MPAMF_ESR associated with that MSC, using the error code ERRCODE == 11 and capturing MSMON_CFG_MON_SEL.{RIS, MON_SEL}.

Access to an MSMON_<type>_* register when MSMON_CFG_MON_SEL.RIS does not correspond to an MPAM resource that has the type of monitor accessed by the MSMON_<type>_* register is CONSTRAINED UNPREDICTABLE, one of:

- RAZ/WI.
- RAZ/WI and record an MPAM error in the MPAMF_ESR associated with that MSC, using the error code ERRCODE == 11 and capturing MSMON_CFG_MON_SEL.{RIS, MON_SEL}.

12.2.13 Reserved (errcodes 12 – 15)

These error codes are reserved for future use.

12.3 Overwritten error status

When MPAMF_ESR is written due to an error, and the ERRCODE field was not previously 0, the OVRWR bit is set. Error status is always written to MPAMF_ESR, whether or not it contains a previously recorded error syndrome.

Table 12-2 Overwritten error status

OVRWR	ERRCODE	Description
0	0b0000	No errors have been recorded in MPAMF_ESR.
0	Non-zero	Not overwritten. A single error has been written to MPAMF_ESR since it was last cleared.
1	0b0000	This state is not produced by hardware, only by a software write.
1	Non-zero	Overwritten. Two or more errors have been written to MPAMF_ESR with only the syndrome information from the latest error recorded into the fields.

The interrupt service routine should clear both the ERRCODE and OVRWR fields of MPAMF_ESR after its contents have been read. This allows the OVRWR bit to accurately indicate when one or more errors have been overwritten before servicing future MPAM error interrupts.

12.4 Behavior of configuration reads and writes with errors

12.4.1 Writing an out-of-range PARTID to MPAMCFG_PART_SEL.PARTID_SEL

If a write to [MPAMCFG_PART_SEL](#) has a PARTID_SEL value that is out-of-range, it is IMPLEMENTATION DEFINED whether:

- The contents written to [MPAMCFG_PART_SEL.PARTID_SEL](#) are not checked at the time of the write and store the new value into [MPAMCFG_PART_SEL.PARTID_SEL](#). The written out-of-range value could later cause a PARTID_SEL out-of-range error (ERRCODE = 1) when used to index an access to another configuration register by PARTID_SEL. See [Required error condition detection on page 12-403](#) for more information about the optionality of error detection.
- The contents being written to [MPAMCFG_PART_SEL.PARTID_SEL](#) are checked before updating the [MPAMCFG_PART_SEL](#) register. If the error is detected, the [MPAMCFG_PART_SEL](#) register is not updated and the PARTID_SEL out-of-range error (ERRCODE = 1) is raised. To implement this behavior, the implementation must detect the error.

12.4.2 Reading another MPAMCFG_* register when MPAMCFG_PART_SEL.PARTID_SEL contains an out-of-range PARTID

A read of any MPAMCFG_* register other than [MPAMCFG_PART_SEL](#) when [MPAMCFG_PART_SEL.PARTID_SEL](#) contains an out-of-range PARTID raises a PARTID_SEL out-of-range error (ERRCODE = 1) if that error is detected. See [Required error condition detection on page 12-403](#) for more information about the optionality of error detection.

It is IMPLEMENTATION DEFINED whether the value returned by a read of another MPAMCFG_* register when [MPAMCFG_PART_SEL.PARTID_SEL](#) contains an out-of-range PARTID that is detected:

- Is an UNKNOWN value.
- Is a constant value of zero in all fields.

The value returned by a read of another MPAMCFG_* register when [MPAMCFG_PART_SEL.PARTID_SEL](#) contains an out-of-range PARTID that is not detected is an UNKNOWN value.

———— **Note** —————

In an implementation that chooses the IMPLEMENTATION DEFINED option to detect out-of-range PARTID_SEL values and to not update the [MPAMCFG_PART_SEL](#) register, it is not possible to have an out-of-range PARTID_SEL value in that register and the precondition for this section cannot occur. See [Writing an out-of-range PARTID to MPAMCFG_PART_SEL.PARTID_SEL](#).

12.4.3 Writing another MPAMCFG_* register when MPAMCFG_PART_SEL.PARTID_SEL contains an out-of-range PARTID

A write of any MPAMCFG_* register other than [MPAMCFG_PART_SEL](#) when [MPAMCFG_PART_SEL.PARTID_SEL](#) contains an out-of-range PARTID raises a PARTID_SEL out-of-range error (ERRCODE = 1) if that error is detected. See [Required error condition detection on page 12-403](#) for more information about the optionality of error detection.

If a write to an MPAMCFG_* register other than [MPAMCFG_PART_SEL](#) has a PARTID_SEL out-of-range error (ERRCODE = 1), whether that error is detected or not detected, it is IMPLEMENTATION DEFINED whether:

- The write updates the configuration register indexed by an UNKNOWN in-range PARTID.
- The write is ignored (WI).

Note

In an implementation that chooses the IMPLEMENTATION DEFINED option to detect out-of-range PARTID_SEL values and to not update the MPAMCFG_PART_SEL register, it is not possible to have an out-of-range PARTID_SEL value in that register and the precondition for this section cannot occur. See *Writing an out-of-range PARTID to MPAMCFG_PART_SEL.PARTID_SEL* on page 12-398.

12.4.4 Writing an undefined RIS to MPAMCFG_PART_SEL.RIS

If RIS is implemented and a configuration write to MPAMCFG_PART_SEL.RIS has an Undefined RIS error (ERRCODE = 8), it is IMPLEMENTATION DEFINED whether:

- The contents written to MPAMCFG_PART_SEL.RIS are not checked at the time of the write and store the new value in MPAMCFG_PART_SEL.RIS. This undefined RIS value could cause an Undefined RIS error (ERRCODE = 8) when later used to select a resource on an access to a configuration register by PARTID_SEL and RIS.
- The contents being written to MPAMCFG_PART_SEL.RIS are checked before updating the MPAMCFG_PART_SEL register. If the error is detected, the MPAMCFG_PART_SEL register is not updated and the Undefined RIS error (ERRCODE = 8) is raised. To implement this behavior, the implementation must detect the error.

12.4.5 Reading other MSC MPAM registers when MPAMCFG_PART_SEL.RIS contains an undefined RIS value

A read of an MPAMF*IDR register or an MPAMCFG_* register other than MPAMCFG_PART_SEL when MPAMCFG_PART_SEL.RIS contains an undefined RIS value raises an Undefined RIS error (ERRCODE = 8) if the implementation detects that error. See *Required error condition detection on page 12-403* for more information about the optionality of error detection. If the error is not detected, the value returned is UNKNOWN.

The value read from an MPAMF*IDR or an MPAMCFG_* register other than MPAMCFG_PART_SEL when MPAMCFG_PART_SEL.RIS contains a RIS value that does not correspond to an implemented resource instance returns an UNKNOWN value.

Note

In an implementation that chooses the IMPLEMENTATION DEFINED option to detect undefined RIS values and to not update the MPAMCFG_PART_SEL register, it is not possible to have an undefined RIS value in that register and the precondition for this section cannot occur. See *Writing an undefined RIS to MPAMCFG_PART_SEL.RIS*.

12.4.6 Writing other MSC MPAM registers when MPAMCFG_PART_SEL.RIS contains an undefined RIS value

A write of an MPAMCFG_* register other than MPAMCFG_PART_SEL when MPAMCFG_PART_SEL.RIS contains an undefined RIS value raises an Undefined RIS error (ERRCODE = 8) if that error is detected. See *Required error condition detection on page 12-403* for more information about the optionality of error detection.

If a configuration write to an MPAMCFG_* register other than MPAMCFG_PART_SEL has a RIS value that does not correspond to an implemented resource instance, whether the undefined RIS error is detected or not detected, it is IMPLEMENTATION DEFINED whether:

- The write might update the configuration register for any implemented resource instance.
- The write is ignored (WI).

———— **Note** ————

In an implementation that chooses the IMPLEMENTATION DEFINED option to detect undefined RIS values and to not update the `MPAMCFG_PART_SEL` register, it is not possible to have an undefined RIS value in that register and the precondition for this section cannot occur. See [Writing an undefined RIS to MPAMCFG_PART_SEL.RIS on page 12-399](#).

12.4.7 Reads of MSC MPAM registers with other errors

If there is no `PARTID_SEL` out-of-range error (`ERRCODE = 1`) and no Undefined RIS error (`ERRCODE = 8`), a configuration read to an `MPAM*IDR` or an `MPAMCFG_*` register that has any other errors detected returns an UNKNOWN value.

12.4.8 Writes to MSC MPAM registers with other errors

If there is no `PARTID_SEL` out-of-range error (`ERRCODE = 1`) and no Undefined RIS error (`ERRCODE = 8`), a configuration write to an `MPAMCFG_*` register that has any other errors detected leaves the control settings for the partition selected by `MPAMCFG_PART_SEL.PARTID_SEL` and `MPAMCFG_PART_SEL.RIS` in an UNKNOWN state.

12.4.9 Writes to `MSMON_CFG_MON_SEL.MON_SEL`

Writes to `MSMON_CFG_MON_SEL` that have the `MON_SEL` field out-of-range for the monitors of the MSC cannot generally be detected when the `MON_SEL` register is written because different types of monitors could have different numbers of supported monitor instances. If RIS is also implemented, then the resource instance selector being written into the RIS field could change which monitor types are available and how many monitor instances of each type are implemented because different resource instances could have different numbers of monitor instances from the same resource type.

There are limited cases where `MSMON_CFG_MON_SEL.MON_SEL` could be checked when written:

- RIS is not implemented and only a single monitor type is supported.
- RIS is not supported and all supported monitor types have exactly the same number of monitor instances.
- RIS is supported and all monitor types of all resource instances support exactly the same number of monitor instances.
- RIS is supported, different resource instances support a different number of monitor instances, and all monitor types of each resource instance support exactly the same number of monitor instances. In this case the RIS value must be used to determine the maximum number of monitor instances to check the `MON_SEL` value.

Checking for out-of-range `MON_SEL` when `MSMON_CFG_MON_SEL` is written is an implementation option because some of the detectable cases could be common.

If a configuration write to `MSMON_CFG_MON_SEL` has a `MON_SEL` value that is out-of-range, it is IMPLEMENTATION DEFINED whether:

- The contents written to `MSMON_CFG_MON_SEL.MON_SEL` are not checked at the time of the write and store the new value into the register. The written out-of-range value could later cause a `MON_SEL` out-of-range error (`ERRCODE = 5`) when used to index an access to a `MSMON_CFG_*` configuration register or `MSMON_*` monitor or capture register by `MON_SEL`.
- The contents being written to `MSMON_CFG_MON_SEL.MON_SEL` are checked before updating the `MSMON_CFG_MON_SEL` register. If the error is detected, the `MSMON_CFG_MON_SEL` register is not updated and the `MON_SEL` out-of-range error (`ERRCODE = 5`) is raised. See [Required error condition detection on page 12-403](#) for more information about the optionality of error detection.

12.4.10 Reading another MSMON_* register when MSMON_CFG_MON_SEL.MON_SEL out of range

A read of any MSMON_* register other than [MSMON_CFG_MON_SEL](#) when [MSMON_CFG_MON_SEL.MON_SEL](#) contains an out-of-range monitor instance selector raises a Monitor Range error (ERRCODE == 5) if that error is detected. See [Required error condition detection on page 12-403](#) for more information about the optionality of error detection.

The value read from any MSMON_* register other than [MSMON_CFG_MON_SEL](#) when [MSMON_CFG_MON_SEL.MON_SEL](#) contains an out-of-range monitor instance selector returns an UNKNOWN value whether the Monitor Range error is detected or not detected.

———— **Note** —————

In an implementation that chooses the IMPLEMENTATION DEFINED option to detect out-of-range MON_SEL values and to not update the [MSMON_CFG_MON_SEL](#) register, it might not be possible to have an out-of-range MON_SEL value in that register and the precondition for this section cannot occur. Section [Writes to MSMON_CFG_MON_SEL.MON_SEL on page 12-400](#) lists the conditions necessary to permit the choice of this option.

12.4.11 Writes to MSMON_* registers with MSMON_CFG_MON_SEL.MON_SEL out of range

A write of any MSMON_* register other than [MSMON_CFG_MON_SEL](#) when [MSMON_CFG_MON_SEL.MON_SEL](#) contains an out-of-range monitor instance selector, raises a Monitor Range error (ERRCODE == 5) if that error is detected. See [Required error condition detection on page 12-403](#) for more information about the optionality of error detection.

If a write is to an MSMON_* register other than [MSMON_CFG_MON_SEL](#) when [MSMON_CFG_MON_SEL.MON_SEL](#) is out-of-range, whether the error is detected or not detected, it is IMPLEMENTATION DEFINED whether:

- The write could update an MSMON_* register indexed by any in-range monitor instance selector.
- The write is ignored (WI).

———— **Note** —————

In an implementation that chooses the IMPLEMENTATION DEFINED option to detect out-of-range MON_SEL values and to not update the [MSMON_CFG_MON_SEL](#) register, it might not be possible to have an out-of-range MON_SEL value in that register and the precondition for this section cannot occur. [Writes to MSMON_CFG_MON_SEL.MON_SEL on page 12-400](#) lists the conditions necessary to permit the choice of this option.

12.4.12 Writing an undefined RIS to MSMON_CFG_MON_SEL.RIS

If RIS is implemented and a configuration write to [MSMON_CFG_MON_SEL.RIS](#) has a value that does not correspond to an implemented resource instance, it is IMPLEMENTATION DEFINED whether:

- The value written to [MSMON_CFG_MON_SEL.RIS](#) is not checked at the time of the write and the new values are stored in that register. This undefined RIS value could cause an Undefined_RIS_MON_SEL error (ERRCODE = 10) when later used to select a resource on an access to an MSMON_* register by MON_SEL and RIS.
- The contents being written to [MSMON_CFG_MON_SEL.RIS](#) are checked before updating the [MSMON_CFG_MON_SEL](#) register. If the error is detected, the register is not updated and the Undefined_RIS_MON_SEL error (ERRCODE = 10) is raised.

12.4.13 Reading another MSMON_* register when MSMON_CFG_MON_SEL.RIS contains an undefined RIS value

A read of an MSMON_* register other than `MSMON_CFG_MON_SEL` when `MSMON_CFG_MON_SEL.RIS` contains a RIS value that does not correspond to an implemented resource instance raises an `Undefined_RIS_MON_SEL` error (`ERRCODE = 10`) if that error is detected. See *Required error condition detection* on page 12-403 for more information about the optionality of error detection.

The value read from an MSMON_* register other than `MSMON_CFG_MON_SEL` when `MSMON_CFG_MON_SEL.RIS` contains a RIS value that does not correspond to an implemented resource instance returns an UNKNOWN value whether the error is detected or not detected.

———— **Note** —————

In an implementation that chooses the IMPLEMENTATION DEFINED option to detect undefined RIS values and to not update the `MSMON_CFG_MON_SEL` register, it is not possible to have an undefined RIS value in that register and the precondition for this section cannot occur. See *Writing an undefined RIS to MSMON_CFG_MON_SEL.RIS* on page 12-401.

12.4.14 Writing another MSMON_* register when MSMON_CFG_MON_SEL.RIS contains an undefined RIS value

A write of an MSMON_* register other than `MSMON_CFG_MON_SEL` when `MSMON_CFG_MON_SEL.RIS` contains a RIS value that does not correspond to an implemented resource instance raises an `Undefined_RIS_MON_SEL` error (`ERRCODE = 10`) if that error is detected. See *Required error condition detection* on page 12-403 for more information about the optionality of error detection.

If a write to an MSMON_* register other than `MSMON_CFG_MON_SEL` has a RIS value that does not correspond to an implemented resource, whether the undefined RIS error is detected or not detected, it is IMPLEMENTATION DEFINED whether:

- The write might update the MSMON_* register indexed by any implemented resource instance.
- The write is ignored (WI).

———— **Note** —————

In an implementation that chooses the IMPLEMENTATION DEFINED option to detect undefined RIS values and to not update the `MSMON_CFG_MON_SEL` register, it is not possible to have an undefined RIS value in that register and the precondition for this section cannot occur. See *Writing an undefined RIS to MSMON_CFG_MON_SEL.RIS* on page 12-401.

12.5 Optionality of error detection and reporting

Error detection and reporting are required for an error condition when all of the following are true:

- The MSC supports at least one MPAM feature that can raise the error condition.
- The MSC is designed so that the particular error condition can occur.
- The MSC is required to detect the error condition, see *Required error condition detection*.

If there are no error conditions that meet these criteria, then in MPAM v0.1 and from MPAM v1.1, `MPAMF_IDR.HAS_ESR` is permitted to be 0. If `MPAMF_IDR.HAS_ESR` is 1, then `MPAMF_ESR` and `MPAMF_ECR` must be implemented.

In MPAM v1.0, if no error conditions are detected, `MPAMF_ESR` and `MPAMF_ECR` must be RAZ/WI.

12.5.1 Required error condition detection

This section describes the conditions under which each of the MPAM MSC error conditions must be detected. In cases where detection is not required, an implementation might choose not to implement detection and reporting logic for that error condition.

Selector out-of-range errors

The following requirements apply to each of the types of selectors used in MPAM in MSCs, including:

- PARTID.
- PMG.
- Monitor selectors.
- In MPAM v0.1 and from MPAM v1.1, RIS values.

The selector interface is permitted to be narrower than the full width specified in the architecture. Even if the MSC interface is of one size, the internal implementation might be smaller than that size. Bits beyond the implemented width of any selector are permitted to be silently truncated without any requirement to detect or report should those bits be non-zero.

An MSC implementation that supports a range that is not 0 to $2^n - 1$ in a field of n bits for any selector is required to detect and report values that lie within the field size but are not valid in the implementation. Such detection can be applied after performing the silent truncation to the bit-width supported.

PARTID narrowing errors

If PARTID narrowing is supported, the Unexpected Internal error condition must be detected and reported.

Chapter 13

Pseudocode

This chapter identifies the pseudocode that describes the generation of MPAM information by a PE following the MPAM architecture.

The MPAM pseudocode is shared on execution between AArch64 state and between AArch32 state.

MPAM pseudocode functions listed in this section are identified only by a `FunctionName`, without an `AArch64.` or `AArch32.` prefix and without a full description. The functions are organized by functional groups, with the functional groups being indicated by hierarchical path names, for example `shared/functions/extension`.

Only the `FunctionName` is given for each function in this section. For full descriptions of the MPAM pseudocode see the *Arm® Architecture Reference Manual for A-profile architecture* (ARM DDI 0487).

13.1 Shared pseudocode

This section holds the `FunctionName` for the MPAM pseudocode that is common to execution in AArch64 state and in AArch32 state. Functions listed in this section are identified only by a `FunctionName`, without an AArch64. or AArch32. prefix. This section is organized by functional groups, with the functional groups being indicated by hierarchical path names, for example `shared/functions/extension`.

The sections of the shared pseudocode hierarchy containing MPAM pseudocode are:

- `shared/functions/extension`.
- `shared/functions/extension`.
- `shared/functions/mpam`.

13.1.1 shared/functions/extension

The `FunctionName` for each pseudocode function in this section is listed below:

- `shared/functions/extension/HaveEMPAMExt`
- `shared/functions/extension/HaveMPAMExt`.

13.1.2 shared/functions/memory

The `FunctionName` for each pseudocode function in this section is listed below:

- `shared/functions/memory/AccessDescriptor`.
- `shared/functions/memory/CreateAccessDescriptor`.
- `shared/functions/memory/MPAM`.

13.1.3 shared/functions/mpam

The `FunctionName` for each pseudocode function in this section is listed below:

- `shared/functions/mpam/AltPARTIDspace`
- `shared/functions/mpam/AltPidRealm`
- `shared/functions/mpam/AltPidSecure`
- `shared/functions/mpam/DefaultMPAMinfo`.
- `shared/functions/mpam/DefaultPARTID`.
- `shared/functions/mpam/DefaultPMG`.
- `shared/functions/mpam/GenMPAMcurEL`.
- `shared/functions/mpam/MAP_vPARTID`.
- `shared/functions/mpam/MPAMisEnabled`.
- `shared/functions/mpam/MPAMisVirtual`.
- `shared/functions/mpam/PARTIDspaceFromSS`
- `shared/functions/mpam/UsePrimarySpaceEL10`
- `shared/functions/mpam/UsePrimarySpaceEL2`
- `shared/functions/mpam/genMPAM`.
- `shared/functions/mpam/genMPAMel`.
- `shared/functions/mpam/genPARTID`.
- `shared/functions/mpam/genPMG`.
- `shared/functions/mpam/getMPAM_PARTID`.
- `shared/functions/mpam/getMPAM_PMG`.
- `shared/functions/mpam/mapvpmw`.

Appendix A

Generic Resource Controls

This chapter contains the following sections:

- *Introduction* on page A-408.
- *Portion resource controls* on page A-409.
- *Maximum-usage resource controls* on page A-410.
- *Proportional resource allocation facilities* on page A-411.
- *Combining resource controls* on page A-413.

A.1 Introduction

This appendix is informative.

Several of the resource controls defined in this specification fit one of the generic models for resource controls in this appendix.

A.2 Portion resource controls

Some resources may be divided into fixed quanta, termed *portions*, that can be allocated for the exclusive use of a partition or shared between two or more partitions. Figure A-1 shows how partitions can have private and shared Portion Bit Map (PBM) allocations.

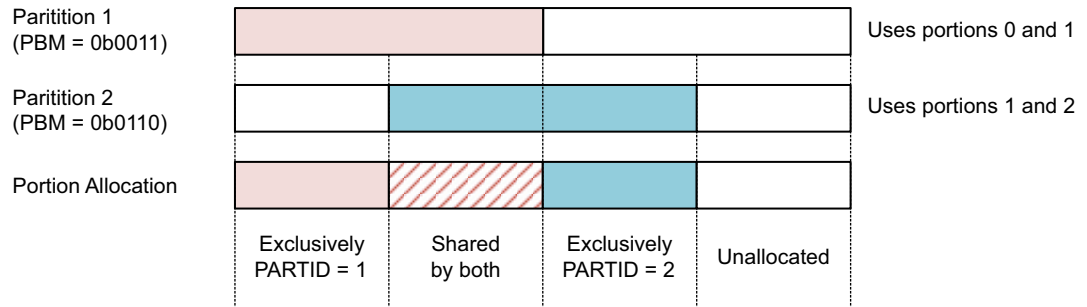

Figure A-1 Generic portion shared and exclusive allocations.

In portion resource controls, the control setting is a bitmap in which each bit corresponds to a particular portion of the resource, as shown in Figure A-2. Each bit grants the PARTID using this control setting to allocate the portion corresponding to that bit.

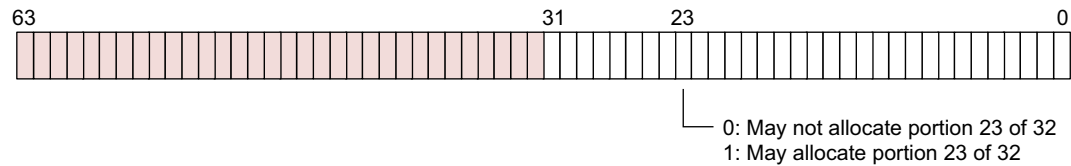

Figure A-2 Generic portion bit map.

PBMs may be wide. Generic PBMs could be up to 2^{15} bits in width.

A PBM is a vector of single-bit elements. Element 0 is bit 0 at the address $(MPAMF_BASE + PBM_offset)$ where PBM_offset is the offset of the particular PBM register. Both the bitmap and the register to access the bitmap extend in length at increasing 32-bit word addresses for the width in bits of the PBM (PBM_WD). If the 32-bit word containing the highest byte of the bitmap $(MPAMF_BASE + PBM_offset + (PBM_WD \gg 3))$ has unused bits, those bits are RES0.

To access the PBM for portion n , access the 32-bit word of the PBM register at the address $MPAMF_BASE + PBM_offset + ((n \gg 3) \& \sim 3)$. Then access bit $(n \& 31)$.

A.3 Maximum-usage resource controls

Many resources can be controlled by a maximum-usage resource control. With this control, resources may be allocated to a partition as long as the partition's maximum usage is not exceeded. If the maximum usage is reached, further allocation must be prevented, or deferred, or lowered in priority, or caused to reclaim a previous allocation, or caused to replace a previous allocation.

Maximum-usage control settings are a maximum fraction of the resource that the PARTID may use. The parameter is represented as a 16-bit fixed-point fraction of the capacity of the resource with a discoverable number of fractional bits. For example, if a resource has an 8-bit fractional width, bits [15:8] of the setting are used to control the resource allocation. To ensure that the range includes 100% of the resource, the control value is increased by 1 in the least significant implemented bit before being used to limit the usage to the maximum. See [About the fixed-point fractional format on page 9-200](#) for the fixed-point fractional format.

A.4 Proportional resource allocation facilities

MPAM proportional stride partitioning is related to two software resource-management interfaces:

- The Linux cgroup weights interface assigns integer weights to indicate the relative proportion of the resource given to a process.
- The VMware shares interface similarly assigns an integer share to indicate the relative proportion of the resource that a virtual machine is given.

Weight and share values are positive integers. For example, Linux group weights are in the range of 1 to 10000, with a default value of 100.

The value of weight or share is used to compute the fraction of the resource, f , for partition, p , as:

$$f(p) = \frac{\text{Weight}_p}{\sum_{\text{all } w} \text{Weight}_w}$$

A partition's stride is the scaled reciprocal of its weight:

$$\text{Stride of } p = \frac{S}{f(p)}$$

The scaling factor, S , should be chosen as equal to the largest $f(p)$ so as to normalize stride values and give the smallest stride in the system = 1. All strides should be scaled by the same S .

Stride-based proportional allocation is well-suited to temporal or rate-of-occurrence resources, such as bandwidth.

The standard interface for proportional allocation is a positive unsigned integer, STRIDEM1, with an IMPLEMENTATION DEFINED field width of w . STRIDEM1 has the range $[0 \dots 2^w - 1]$ so stride has the range $[1 \dots 2^w]$. If a stride after normalization is greater than 2^w , it should be programmed into the control as $2^w - 1$, the largest representable STRIDEM1.

Properties of proportional allocation include:

- Proportion of resource shrinks and grows as partitions come and go.
- Subdividable: If VM A has $\frac{1}{2}$ fraction of the whole resource and its child application, y , has $\frac{2}{3}$ fraction of the VM's resource, then y is given $\frac{1}{2} * \frac{2}{3} = \frac{1}{3}$ fraction of the whole resource.
- Proportional allocation only needs to consider the current contenders for a temporal resource, such as memory bandwidth.
- A proportional allocation scheme is called *work-conserving* if it does not idle the resource when only low-proportion requests are available, but instead uses as much of the resource as it has requests to use. A proportional allocation scheme might allocate the resource to those lower-proportion requests, in proportion to their relative weights.

A.4.1 Model of stride-based memory bandwidth scheduling

This model is intended to explain the operation of stride-based memory bandwidth scheduling without dictating an implementation. Arm believes that a variety of implementations are possible.

In this model, each partition has an $offset[p]$ that tracks the time since the partition, p , consumed bandwidth but is bounded to be less than $offset_limit$. When a request, r , arrives it is given a *deadline*, of the *current_time* plus $stride(p)$ minus $offset(p)$. The $offset(p)$ is set to *current_time* – *deadline*, and the $offset(p)$ is incremented in event-time units until it reaches the $offset_limit$.

In the model, requests are serviced as quickly as possible in deadline order. Newly arriving requests with small strides (highest access to bandwidth) may go ahead of earlier requests with large strides.

If there are requests to process, this model does not prevent servicing a request with a distant future deadline if there are no requests available with earlier deadlines. As such, this model scheme is work-conserving.

A.5 Combining resource controls

Maximum-usage resource controls, portion resource controls, and other resource controls may coexist on the same resource. Combined resource controls should produce a combined effect. For example, combining portion control and maximum-usage control for the same resource should allocate the resource while satisfying both controls.

All resource controls should have at least one setting that does not limit access to the resource. When an implementation contains multiple controls for the same resource, the limits imposed on a partition's usage by each control are all applied. By selecting which controls limit a partition's usage and which do not, software can exercise a variety of regulation styles within a single system.

Appendix B

MSC Firmware Data

This chapter contains the following sections:

- *Introduction* on page B-416.
- *Partitioning-control parameters* on page B-417.
- *Performance-monitoring parameters* on page B-418.
- *Discovery of resource to RIS mapping* on page B-419.
- *Discovery of wired interrupts* on page B-420.

B.1 Introduction

In a system containing MPAM, discovery of the memory-system topology and certain implementation parameters of MPAM controls and monitors must be provided to MPAM-aware software via firmware data. The software-to-firmware interface to the MPAM firmware data is beyond the scope of this description. Examples of firmware data interfaces include:

- ACPI.
- Device Tree.

Firmware data for static devices can be pre-configured for an implementation and stored as part of the firmware, or it can be dynamically discovered through probing and other tests, or some combination of these two approaches.

B.2 Partitioning-control parameters

Table B-1 Partitioning-control parameters.

Control	Parameter	Data Format	Description
MPAM	MPAMF_BASE_NS	Address	Every MPAM-capable device has the MPAMF_IDR MMR at offset 0 from the MPAMF_BASE_NS in the Non-secure address space. Other MPAM memory-mapped registers are at known offsets from this address. See Chapter 11 Memory-mapped Registers .
MPAM	MPAMF_BASE_S	Address	Every MPAM-capable device has the MPAMF_IDR MMR at offset 0 from the MPAMF_BASE_S in the Secure address space. Other MPAM memory-mapped registers are at known offsets from this address. See Chapter 11 Memory-mapped Registers .

B.3 Performance-monitoring parameters

Table B-2 Performance-monitoring parameters

Monitor	Parameter	Data Format	Description
CSU	MAX_NRDY_USEC	Uint32	Maximum number of microseconds that the NRDY signal can remain 1 in the absence of additional reconfiguration of the monitor or writes to the MSMON_CSU register. This firmware value is the maximum time when NRDY can be 1, so that software can know this value. MSMON_CSU.VALUE is accurate and MSMON_CSU.NRDY is zero before MAX_NRDY_USEC microseconds have elapsed since the monitor was configured, reconfigured, or written.

B.4 Discovery of resource to RIS mapping

Software needs to know which RIS value to use to control a resource instance of the MSC.

This mapping is not available from MSC IDRs. It might be given as a firmware data table or other means beyond the hardware ID registers.

B.5 Discovery of wired interrupts

There are two interrupt sources in an MPAM MSC and they are replicated in the Secure and Non-secure MPAM behaviors. It is not possible to discover the connection of the four interrupts to GIC inputs from the MSC MPAM ID registers. This information must come from the firmware information.

Firmware must provide information on the connection and grouping of MPAM wired interrupts.

Glossary

This glossary describes some of the terms that are used in this document. Some of these terms are unique to MPAM and are introduced in this document while others are standard terms that can be found in the Glossary of the *Arm® Architecture Reference Manual for A-profile architecture*.

Abort

An exception caused by an illegal memory access. Aborts can be caused by the external memory system or the MMU.

Aligned

A data item stored at an address that is exactly divisible by the highest power of 2 that divides exactly into its size in bytes. Aligned halfwords, words and doublewords therefore have addresses that are divisible by 2, 4, and 8, respectively.

ALTSP

Alternative PARTID space.

AMBA

Advanced Microcontroller Bus Architecture. The AMBA family of protocol specifications is the Arm open standard for on-chip buses. AMBA provides solutions for the interconnection and management of the functional blocks that make up a *System-on-Chip* (SoC). Applications include the development of embedded systems with one or more processors or signal processors and multiple peripherals.

Banked register

A register that has multiple instances, with the instance that is in use depending on the PE mode, Security state, or other PE state.

Burst A group of transfers that form a single transaction. With AMBA protocols, only the first transfer of the burst includes address information, and the transfer type determines the addresses used for subsequent transfers.

BWA BandWidth Allocation.

BWPBM BandWidth Portion Bit Map.

CONSTRAINED UNPREDICTABLE

Where an instruction can result in UNPREDICTABLE behavior, the Armv8 architecture specifies a narrow range of permitted behaviors. This range is the range of CONSTRAINED UNPREDICTABLE behavior. All implementations that are compliant with the architecture must follow the CONSTRAINED UNPREDICTABLE behavior.

Execution at Non-secure EL1 or EL0 of an instruction that is CONSTRAINED UNPREDICTABLE can be implemented as generating a trap exception that is taken to EL2, provided that at least one instruction that is not UNPREDICTABLE and is not CONSTRAINED UNPREDICTABLE causes a trap exception that is taken to EL2.

In body text, the term CONSTRAINED UNPREDICTABLE is shown in SMALL CAPITALS.

See also UNPREDICTABLE.

Core See *Processing element (PE)*.

CPBM Cache-Portion Bit Map.

CSU Cache-Storage Usage.

Downstream Information propagating in the direction from Requesters towards terminating Completer components.

DSB Data Synchronization Barrier.

E2H EL2 Host. A bit field in the HCR_EL2 register. This configuration executes a type-2 hypervisor and its host operating system in EL2 rather than EL1, for better performance.

Type-2 hypervisors run on a host operating system rather than running as a small, standalone OS-like program. For example, kvm is a type-2 hypervisor.

HCR An abbreviated reference to the Hypervisor Configuration Registers in AArch64 HCR_EL2 and in AArch32 HCR and HCR2.

ICN InterConnect Network.

ID An identifier or label.

Intermediate physical address (IPA)

An implementation of virtualization, the address to which a Guest OS maps a VA. A hypervisor might then map the IPA to a PA. Typically, the Guest OS is unaware of the translation from IPA to PA.

See also *Physical address (PA)*, *Virtual address (VA)*.

IPA See *Intermediate physical address (IPA)*.

kvm Kernel-based Virtual Machine, an open-source software package that implements a type-2 hypervisor within Linux.

LPI Locality-specific Peripheral Interrupt.

MBWU Memory BandWidth Usage.

Memory-system component

MSC. A function, unit, or design block in a memory system that can have partitionable resources. MSCs consist of all units that handle load or store requests issued by any MPAM Requester. These include cache memories, interconnects, memory management units, memory channel controllers, queues, buffers, rate adaptors, etc. An MSC may contain one or more resources that each may have zero or more resource partitioning controls. For example, a PE may contain several caches, each of which might have zero or more resource partitioning controls.

Memory-system resource

A resource that affects the performance of software's use of the memory system and is either local to an MSC (such as cache-memory capacity) or non-local (such as memory bandwidth, which is present over an entire path, from Requester to Completer, that may pass through multiple MSCs).

MMR	Memory-mapped Register.
MPAM	Memory system resource Partitioning and Monitoring.
MPAM information	The MPAM information bundle, comprising PARTID, PMG, and MPAM_NS.
MPAM_NS	MPAM security-space bit. It is not stored in a PE register; it comes from the current Security state of a PE and is communicated to MSCs as part of the MPAM information bundle. In non-PE Requesters, the Security state can be determined in other ways.
MPAM_SP	In MPAM for RME the MPAM PARTID space indication.
MSC	Memory-system Component. See Memory-system component .
MSI	Message signaled interrupts. Signaled using a memory write that is usually directed at an interrupt translation service.
NRDY	Not-Ready bit. MPAM resource monitors set this bit to indicate that the monitor register does not currently have an accurate value.
NS	Non-Secure. A bit indicating that an address space is not Secure.
PA	See Physical address (PA) .
PARTID	Partition ID. Together with the MPAM_NS bit, it selects a memory-system resource partition to use in the MSCs. For each resource with a resource partitioning control in each MSC, the PARTID and MPAM_NS select resource control levels, limits, or allocations from local control-setting tables.
Partition	A division of resources. A partition is manifest in a PARTID and MPAM_NS. In an MSC, the PARTID and MPAM_NS select partitioning control settings that affect the partitioning by regulating the allocation of the resource to requests using that PARTID and MPAM_NS.
PE	See Processing element (PE) .
Physical address (PA)	An address that identifies a location in the physical memory map. See also Intermediate physical address (IPA) , Virtual address (VA) .
Physical PARTID	A partition ID that is transmitted with memory requests and can be used by MSCs to control resources usage. A physical PARTID is in either the Non-secure or Secure PARTID space. If MPAM for RME is implemented, there are two additional PARTID spaces, Realm PARTID space and Root PARTID space.
PMG	Performance Monitoring Group, a property of a partition used in MSCs by MPAM performance monitors that can be programmed to be sensitive to the particular PARTID and PMG combination.
Portion	A uniquely identifiable part of the resource. It is of fixed size or capacity. A particular resource has a constant number of portions. Portions are distinct. Portion n is the same part of the resource for every partition. Thus, every partition that is given access to a portion n shares access to portion n.
PPI	Private Peripheral Interrupt.
Processing element (PE)	The abstract machine defined in the Arm architecture, as documented in an Arm Architecture Reference Manual. A PE implementation compliant with the Arm architecture must conform with the behaviors described in the corresponding Arm Architecture Reference Manual.
RAZ	See Read-As-Zero (RAZ) .
RAZ/WI	Read-As-Zero, Writes Ignored. Hardware must implement the field as Read-as-Zero, and must ignore writes to the field. Software can rely on the field reading as all 0s, and on writes being ignored.

This description can apply to a single bit that reads as 0, or to a field that reads as all 0s.

See also [Read-As-Zero \(RAZ\)](#).

Read-As-Zero (RAZ)

Hardware must implement the field as reading as all 0s.

Software:

- Can rely on the field reading as all 0s.
- Must use a SBZP policy to write to the field.

This description can apply to a single bit that reads as 0, or to a field that reads as all 0s.

See also [RAZ/WI](#), [RES0](#).

RES0

A reserved bit. Used for fields in register descriptions, and for fields in architecturally-defined data structures that are held in memory, for example in translation table descriptors.

Within the architecture, there are some cases where a register bit or field:

- Is RES0 in some defined architectural context.
- Has different defined behavior in a different architectural context.

———— **Note** ————

- RES0 is not used in descriptions of instruction encodings.
- Where an AArch32 System register is Architecturally mapped to an AArch64 System register, and a bit or field in that register is RES0 in one Execution state and has defined behavior in the other Execution state, this is an example of a bit or field with behavior that depends on the architectural context.

This means the definition of RES0 for fields in read/write registers is:

If a bit is RES0 in all contexts

For a bit in a read/write register, it is IMPLEMENTATION DEFINED whether:

1. The bit is hardwired to 0. In this case:
 - Reads of the bit always return 0.
 - Writes to the bit are ignored.
2. The bit can be written. In this case:
 - An indirect write to the register sets the bit to 0.
 - A read of the bit returns the last value successfully written, by either a direct or an indirect write, to the bit.
If the bit has not been successfully written since reset, then the read of the bit returns the reset value if there is one, or otherwise returns an UNKNOWN value.
 - A direct write to the bit must update a storage location associated with the bit.
 - The value of the bit must have no effect on the operation of the PE, other than determining the value read back from the bit, unless this Manual explicitly defines additional properties for the bit.

Whether RES0 bits or fields follow behavior 1 or behavior 2 is IMPLEMENTATION DEFINED on a field-by-field basis.

If a bit is RES0 only in some contexts

For a bit in a read/write register, when the bit is described as RES0:

- An indirect write to the register sets the bit to 0.
- A read of the bit must return the value last successfully written to the bit, by either a direct or an indirect write, regardless of the use of the register when the bit was written.

If the bit has not been successfully written since reset, then the read of the bit returns the reset value if there is one, or otherwise returns an UNKNOWN value.

- A direct write to the bit must update a storage location associated with the bit.
- While the use of the register is such that the bit is described as RES0, the value of the bit must have no effect on the operation of the PE, other than determining the value read back from that bit, unless this Manual explicitly defines additional properties for the bit.

Considering only contexts that apply to a particular implementation, if there is a context in which a bit is defined as RES0, another context in which the same bit is defined as RES1, and no context in which the bit is defined as a functional bit, then it is IMPLEMENTATION DEFINED whether:

- Writes to the bit are ignored, and reads of the bit return an UNKNOWN value.
- The value of the bit can be written, and a read returns the last value written to the bit.

The RES0 description can apply to bits or fields that are read-only, or are write-only:

- For a read-only bit, RES0 indicates that the bit reads as 0, but software must treat the bit as UNKNOWN.
- For a write-only bit, RES0 indicates that software must treat the bit as SBZ.

A bit that is RES0 in a context is reserved for possible future use in that context. To preserve forward compatibility, software:

- Must not rely on the bit reading as 0.
- Must use an SBZP policy to write to the bit.

This RES0 description can apply to a single bit, or to a field for which each bit of the field must be treated as RES0.

In body text, the term RES0 is shown in SMALL CAPITALS.

See also [Read-As-Zero \(RAZ\)](#), [RES1](#), [UNKNOWN](#).

RES1

A reserved bit. Used for fields in register descriptions, and for fields in architecturally-defined data structures that are held in memory, for example in translation table descriptors.

Within the architecture, there are some cases where a register bit or field:

- Is RES1 in some defined architectural context.
- Has different defined behavior in a different architectural context.

———— **Note** —————

- RES1 is not used in descriptions of instruction encodings.
- Where an AArch32 System register is Architecturally mapped to an AArch64 System register, and a bit or field in that register is RES1 in one Execution state and has defined behavior in the other Execution state, this is an example of a bit or field with behavior that depends on the architectural context.

This means the definition of RES1 for fields in read/write registers is:

If a bit is RES1 in all contexts

For a bit in a read/write register, it is IMPLEMENTATION DEFINED whether:

1. The bit is hardwired to 1. In this case:
 - Reads of the bit always return 1.
 - Writes to the bit are ignored.
2. The bit can be written. In this case:
 - An indirect write to the register sets the bit to 1.
 - A read of the bit returns the last value successfully written, by either a direct or an indirect write, to the bit.
If the bit has not been successfully written since reset, then the read of the bit returns the reset value if there is one, or otherwise returns an UNKNOWN value.
 - A direct write to the bit must update a storage location associated with the bit.
 - The value of the bit must have no effect on the operation of the PE, other than determining the value read back from the bit, unless this Manual explicitly defines additional properties for the bit.

Whether RES1 bits or fields follow behavior 1 or behavior 2 is IMPLEMENTATION DEFINED on a field-by-field basis.

If a bit is RES1 only in some contexts

For a bit in a read/write register, when the bit is described as RES1:

- An indirect write to the register sets the bit to 1.
- A read of the bit must return the value last successfully written to the bit, regardless of the use of the register when the bit was written.

————— Note —————

As indicated in this list, this value might be written by an indirect write to the register.

If the bit has not been successfully written since reset, then the read of the bit returns the reset value if there is one, or otherwise returns an UNKNOWN value.

- A direct write to the bit must update a storage location associated with the bit.
- While the use of the register is such that the bit is described as RES1, the value of the bit must have no effect on the operation of the PE, other than determining the value read back from that bit, unless this Manual explicitly defines additional properties for the bit.

Considering only contexts that apply to a particular implementation, if there is a context in which a bit is defined as RES0, another context in which the same bit is defined as RES1, and no context in which the bit is defined as a functional bit, then it is IMPLEMENTATION DEFINED whether:

- Writes to the bit are ignored, and reads of the bit return an UNKNOWN value.
- The value of the bit can be written, and a read returns the last value written to the bit.

The RES1 description can apply to bits or fields that are read-only, or are write-only:

- For a read-only bit, RES1 indicates that the bit reads as 1, but software must treat the bit as UNKNOWN.
- For a write-only bit, RES1 indicates that software must treat the bit as SBO.

A bit that is RES1 in a context is reserved for possible future use in that context. To preserve forward compatibility, software:

- Must not rely on the bit reading as 1.
- Must use an SBOP policy to write to the bit.

This RES1 description can apply to a single bit, or to a field for which each bit of the field must be treated as RES1.

In body text, the term RES1 is shown in SMALL CAPITALS.

See also [RES0](#), [UNKNOWN](#).

Reserved

Unless otherwise stated:

- Instructions that are reserved or that access reserved registers have UNPREDICTABLE or CONSTRAINED UNPREDICTABLE behavior.
- Bit positions described as reserved are:
 - In an RW or WO register, RES0.
 - In an RO register, UNK.

RIS

Resource instance selection. The value in [MPAMCFG_PART_SEL](#).RIS selects the resource instance that is configured through MPAMCFG_* registers and described by the MPAMF ID registers. See [RIS controls in MPAMCFG_PART_SEL](#) on page 8-166.

RME

Realm Management Extension. RME specifies how PE execution context is mapped to Security states.

SCR

Part of the name of a Secure Configuration Register.

SMMU

System Memory-Management Unit.

SPE

Statistical Profiling Extension.

SPI

Shared Peripheral Interrupt.

TGE	Trap General Exception. A field in the HCR_EL2 register. It causes EL0 exceptions, that would normally trap to EL1, to instead trap to EL2. This function can be used to run an EL2 host's applications at EL0, so that any exceptions in the application trap to the host OS at EL2.
UNDEFINED	<p>Indicates cases where an attempt to execute a particular encoding bit pattern generates an exception, that is taken to the current Exception level, or to the default Exception level for taking exceptions if the UNDEFINED encoding was executed at EL0. This applies to:</p> <ul style="list-style-type: none"> • Any encoding that is not allocated to any instruction. • Any encoding that is defined as never accessible at the current Exception level. • Some cases where an enable, disable, or trap control means an encoding is not accessible at the current Exception level. <p>If the generated exception is taken to an Exception level that is using AArch32 then it is taken as an Undefined Instruction exception.</p> <p>———— Note —————</p> <p>On reset, the default Exception level for taking exceptions from EL0 is EL1. However, an implementation might include controls that can change this, effectively making EL1 inactive. See the description of the Exception model for more information.</p> <p>—————</p> <p>In body text, the term UNDEFINED is shown in SMALL CAPITALS.</p>
UNKNOWN	<p>An UNKNOWN value does not contain valid data, and can vary from moment to moment, instruction to instruction, and implementation to implementation. An UNKNOWN value must not return information that cannot be accessed at the current or a lower level of privilege using instructions that are not UNPREDICTABLE, are not CONSTRAINED UNPREDICTABLE, and do not return UNKNOWN values.</p> <p>An UNKNOWN value must not be documented or promoted as having a defined value or effect.</p> <p>In body text, the term UNKNOWN is shown in SMALL CAPITALS.</p> <p><i>See also</i> CONSTRAINED UNPREDICTABLE, UNDEFINED, UNPREDICTABLE.</p>
UNPREDICTABLE	<p>Means the behavior cannot be relied upon. UNPREDICTABLE behavior must not perform any function that cannot be performed at the current or a lower level of privilege using instructions that are not UNPREDICTABLE.</p> <p>UNPREDICTABLE behavior must not be documented or promoted as having a defined effect.</p> <p>An instruction that is UNPREDICTABLE can be implemented as UNDEFINED.</p> <p>Execution at Non-secure EL1 or EL0 of an instruction that is UNPREDICTABLE can be implemented as generating a trap exception that is taken to EL2, provided that at least one instruction that is not UNPREDICTABLE and is not CONSTRAINED UNPREDICTABLE causes a trap exception that is taken to EL2.</p> <p>In body text, the term UNPREDICTABLE is shown in SMALL CAPITALS.</p> <p><i>See also</i> CONSTRAINED UNPREDICTABLE, UNDEFINED.</p>
Upstream	Information propagating in the direction from terminating Completer components towards Requesters.
VA	<i>See</i> Virtual address (VA) .
Virtual address (VA)	<p>An address generated by an Arm PE. This means it is an address that might be held in the program counter of the PE. For a PMSA implementation, the virtual address is identical to the physical address.</p> <p><i>See also</i> Intermediate physical address (IPA), Physical address (PA).</p>
Virtual PARTID	One of a small range of PARTIDs that can be used by a virtual machine (VM). Virtual PARTIDs are mapped into physical PARTIDs using the virtual partition mapping entries in the MPAMVPM0 - MPAMVPM7 registers.
VM	Virtual Machine.

VMM	Virtual Machine Monitor. An alias for “hypervisor”.
Word	A 32-bit data item. Words are normally word-aligned in Arm systems.
Word-aligned	Means that the address is divisible by 4.