

# Intel<sup>®</sup> Architecture Instruction Set Extensions and Future Features

**Programming Reference**

---

**March 2025**

**319433-057**

## Notices & Disclaimers

**This document contains information on products in the design phase of development. The information here is subject to change without notice. Do not finalize a design with this information.**

Intel technologies may require enabled hardware, software or service activation.

No product or component can be absolutely secure.

Your costs and results may vary.

You may not use or facilitate the use of this document in connection with any infringement or other legal analysis concerning Intel products described herein. You agree to grant Intel a non-exclusive, royalty-free license to any patent claim thereafter drafted which includes subject matter disclosed herein.

All product plans and roadmaps are subject to change without notice.

The products described may contain design defects or errors known as errata which may cause the product to deviate from published specifications. Current characterized errata are available on request.

Intel disclaims all express and implied warranties, including without limitation, the implied warranties of merchantability, fitness for a particular purpose, and non-infringement, as well as any warranty arising from course of performance, course of dealing, or usage in trade.

Code names are used by Intel to identify products, technologies, or services that are in development and not publicly available. These are not "commercial" names and not intended to function as trademarks.

No license (express or implied, by estoppel or otherwise) to any intellectual property rights is granted by this document, with the sole exception that a) you may publish an unmodified copy and b) code included in this document is licensed subject to the Zero-Clause BSD open source license (0BSD), <https://opensource.org/licenses/0BSD>. You may create software implementations based on this document and in compliance with the foregoing that are intended to execute on the Intel product(s) referenced in this document. No rights are granted to create modifications or derivatives of this document.

© Intel Corporation. Intel, the Intel logo, and other Intel marks are trademarks of Intel Corporation or its subsidiaries. Other names and brands may be claimed as the property of others.

# Revision History

Revision	Description	Date
-048	<ul style="list-style-type: none"> <li>Chapter 1: Updated Table 1-2, "Recent Instruction Set Extensions / Features Introduction in Intel® 64 and IA-32 Processors." Updated the CPUID instruction.</li> <li>Chapter 3: Added the TCMIMFP16PS/TCMMLFP16PS instructions.</li> <li>Chapter 4: The majority of the chapter was updated to describe the UC-lock disable feature.</li> <li>Chapter 8: Significant updates throughout the chapter. Added new Section 8.3.2, "Counters Snapshotting," new Section 8.4, "LBR Enhancements," and new Section 8.5, "PerfMon MSRs Aliasing."</li> <li>Removal of chapters: Removed previous Chapter 4, "Non-Write-Back Lock Disable Architecture." Removed previous Chapter 5, "Bus Lock and VM Notify." Removed previous Chapter 8, "Asynchronous Enclave Exit Notify and the EDECCSSA User Leaf Function." The information from these chapters can be found in the Intel 64 and IA-32 Architectures Software Developer's Manuals.</li> </ul>	March 2023
-049	<ul style="list-style-type: none"> <li>Chapter 1: Updated Table 1-1, "Signature Values of DisplayFamily_DisplayModel." Updated Table 1-2, "Recent Instruction Set Extensions / Features Introduction in Intel® 64 and IA-32 Processors." Updated the CPUID instruction with bits enumerating new features. Updated the CPUID instruction to add the initial EAX value to each main CPUID leaf name in order to accommodate new bookmarks in the final PDF that will enable readers to jump to any main CPUID leaf of interest. Where there are multiple initial EAX values, those values have been tagged so they will show up underneath the main CPUID leaf name in the final PDF.</li> <li>Chapter 2: Added the PBNDKB, updated PCONFIG, VDPW[SU,US,UU]D[,S], VSHA512MSG1, VSHA512MSG2, VSHA512RNDS2, VSM3MSG1, VSM3MSG2, VSM3RNDS2, VSM4KEY4, and VSM4RNDS4 instructions.</li> <li>Chapter 8: Added notes regarding the availability of the IA32_PERF_CAPABILITIES.PEBS_FMT of 6.</li> <li>Removed previous Chapter 10, "Virtualization of the IA32_SPEC_CTRL MSR." This information can be found in the Intel 64 and IA-32 Architectures Software Developer's Manuals.</li> <li>Added new Chapter 11, "Total Storage Encryption in Intel Architecture."</li> <li>Updated text changes and change bars from using the color green to use the color violet for better accessibility for all readers.</li> </ul>	June 2023
-050	<ul style="list-style-type: none"> <li>Chapter 1: Updated Table 1-1, "Signature Values of DisplayFamily_DisplayModel." Updated Table 1-2, "Recent Instruction Set Extensions / Features Introduction in Intel® 64 and IA-32 Processors." Updated the CPUID instruction with bits enumerating new features.</li> <li>Chapter 2: Updated the CPUID feature flag for the PBNDKB instruction. Updated the VBCSTNEBF162PS, VCVTNEEBF162PS, and VCVTNEOBF162PS instructions to remove an inaccurate statement from the descriptions. Updated the RDMSRLIST and WRMSRLIST instructions. Added the URMSR and UWRMSR instructions.</li> <li>Chapter 5: Information on Cache Bandwidth Allocation added.</li> <li>Chapter 8: Future performance monitoring features added, including Auto Counter Reload (ACR).</li> <li>Typo corrections throughout as necessary.</li> </ul>	September 2023

Revision	Description	Date
-051	<ul style="list-style-type: none"> <li>• Chapter 1: Updated Table 1-2, "Recent Instruction Set Extensions / Features Introduction in Intel® 64 and IA-32 Processors." Updated the CPUID instruction with bits enumerating the LKGS instruction and the FRED, NMI-source reporting, and INVD execution prevention features. Updated the CPUID instruction to remove "ECX = 0" from the Last Branch Records Information Leaf (1CH) listing because this leaf does not support sub-leaves.</li> <li>• Chapter 2: Updated the RDMSRLIST and WRMSRLIST instructions to remove an erroneous exception. Updated the WRMSRLIST instruction to move one line of pseudocode in the Operation section. Updated the URDMSR and UWRMSR instructions to remove incorrect statement(s) from the Description section, added information to the Virtualization Behavior section, and corrected the first exception listed in the 64-Bit Mode Exceptions section.</li> <li>• Chapter 6: Typo corrections in Section 6.1, "Enumeration, Enabling, and Configuration," and Section 6.8, "Intel® SGX Interactions." Three instances of "CR3.LAM_SUP" were changed to "CR4.LAM_SUP."</li> <li>• Chapter 8: Added footnotes and a note regarding the RDPMC Metrics Clear feature to highlight that this feature is in the design phase of development and the information provided on this feature is subject to change without notice.</li> <li>• Various chapters: Typo corrections as needed.</li> </ul>	December 2023
-052	<ul style="list-style-type: none"> <li>• Chapter 1: Updated Table 1-1, "CPUID Signature Values of DisplayFamily_DisplayModel," to remove processors that have moved into the Intel® 64 and IA-32 Architectures Software Developer's Manual. Updated Table 1-2, "Recent Instruction Set Extensions / Features Introduction in Intel® 64 and IA-32 Processors." Updated the CPUID instruction with bits enumerating ACR updates, user-timer events, monitorless MWAIT, Intel® AVX10.1, and Intel® APX.</li> <li>• Chapter 8: Added fixed-function counter information, removed footnotes from the RDPMC Metrics Clear feature, removed the ACR PREVENT_RELOAD feature.</li> <li>• Added new Chapter 12, "Flexible UIRET."</li> <li>• Added new Chapter 13, "User-Timer Events and Interrupts."</li> <li>• Added new Chapter 14, "APIC-Timer Virtualization."</li> <li>• Added new Chapter 15, "VMX Support for the IA32_SPEC_CTRL MSR."</li> <li>• Added new Chapter 16, "Processor Trace Trigger Tracing."</li> <li>• Added new Chapter 17, "Monitorless MWAIT."</li> <li>• Various chapters: Typo corrections as needed.</li> </ul>	March 2024
-053	<ul style="list-style-type: none"> <li>• Chapter 1: Minor updates/corrections. Updated CPUID Leaf 06H, EAX bit 18, to align with text used in the Intel® 64 and IA-32 Architectures Software Developer's Manual, Volume 3B, Chapter 15. Added the field name and definition of CPUID Leaf 06H, EAX bit 22. Updated CPUID Leaf 07H, Subleaf 2, to add enumeration for MONITOR_MITG_NO.</li> <li>• Chapter 2: Minor updates only.</li> <li>• Chapter 16: Extensive updates to provide additional information and clarity on this feature.</li> </ul>	June 2024

Revision	Description	Date
-054	<ul style="list-style-type: none"> <li>Removed entries from the Revision History table that were older than two years.</li> <li>Chapter 1: Updated Table 1-1, "CPUID Signature Values of DisplayFamily_DisplayModel," to add values for future processors based on Diamond Rapids microarchitecture. Updated Table 1-2, "Recent Instruction Set Extensions / Features Introduction in Intel® 64 and IA-32 Processors." Updated the CPUID instruction with corrections as necessary; added bits enumerating MOVRS, AMX-FP8, MSR_IMM, AMX-TRANPOSE, AMX-TF32, AMX-AVX512, AMX-MOVRS, and Architectural PEBS; and added CPUID Leaf 23H, Subleaves 4 and 5. Added FP8 format information.</li> <li>Chapter 2: Added the MOVRS and PREFETCHRST2 instructions. Added the EVEX forms of the VSM4KEY4 and VSM4RND4 instructions. Updated the WRMSRNS instruction with the immediate form. Added the RDMSR instruction and updated it with the immediate form.</li> <li>Chapter 3: Added the following Intel AMX instructions: T2RPNTLVW[Z0,Z1][,T1], T2RPNTLVW[Z0,Z1]RS[T1], TCONJTCMMIMFP16PS, TCONJTFP16,TCVTROWD2PS, TCVTROWPS2PBF16[H,L], TCVTROWPS2PH[H,L],TDP[B,H,BH,HB]F8PS, TILELOADRS[T1], TILEMOVROW,TMMULTF32PS, TTCMM[IM,RL]FP16PS, TTDPBF16PS,TTDPFP16PS, TTMMULTF32PS, TTRANPOSED. Removed the TDPFP16PS instruction; this can be found in the Intel 64 and IA-32 Architectures Software Developer's Manuals.</li> <li>Added new Chapter 11, "Architectural PEBS."</li> <li>Added new Chapter 12, "MOVRS Instructions."</li> <li>Removal of chapters: Removed previous Chapter 4, "UC-Lock Disable." Removed previous Chapter 6, "Linear Address Masking (LAM)." Removed previous Chapter 7, "Code Prefetch Instruction Updates." Removed previous Chapter 8, "Next Generation Performance Monitoring Unit (PMU)." Removed previous Chapter 9, "Linear Address Space Separation (LASS)." Removed previous Chapter 12, "Flexible UIRET." Removed previous Chapter 15, "VMX Support for the IA32_SPEC_CTRL MSR." The information from these chapters can be found in the Intel 64 and IA-32 Architectures Software Developer's Manuals.</li> </ul>	October 2024
-055	<ul style="list-style-type: none"> <li>Removed an incorrect line in the revision history to ensure the document contents are accurately represented. All change bars in the document remain to reflect Revision 054 edits.</li> <li>Removed an inaccurate value in Table 1-1, "CPUID Signature Values of DisplayFamily_DisplayModel."</li> </ul>	October 2024
-056	<ul style="list-style-type: none"> <li>Chapter 1: Added Panther Lake to Architectural PEBS in Table 1-2, "Recent Instruction Set Extensions / Features Introduction in Intel® 64 and IA-32 Processors." Added footnote for CPUID Leaf 0AH, ECX and EDX; and CPUID Leaf 23H (ECX=1), EDX in Table 1-3, "Information Returned by CPUID Instruction" for fixed-function counters. Added #Guest Physical Address Bits to CPUID Leaf 80000008H, EAX[23:16].</li> <li>Chapter 2: Updated descriptions for AADD, AAND, AOR, and AXOR. Added reference footnote for EVEX opcode version of RDMSR and WRMSRNS.</li> <li>Chapter 3: Corrected typo for CPUID Feature Flag of "TTDPFP16PS—Dot Product and Transpose of FP16 Tiles Accumulated into Packed Single Precision Tile." Added helper function to zero out of range columns in Section 3.4, "Helper Functions" and to T2RPNTLVW, TDP, and TILELOADRS. Updated name of TCVTROWPS2PBF16 to TCVTROWPS2BF16.</li> <li>Chapter 4: Added new Section 4.2, "Memory Regions," Section 4.3, "Region Aware Memory Bandwidth Monitoring (MBM)," and Section 4.4, "Region Aware Memory Bandwidth Allocation (MBA)."</li> <li>Added new Chapter 13, "VMX Enhancements."</li> </ul>	December 2024

Revision	Description	Date
-057	<ul style="list-style-type: none"> <li>• Chapter 1: Added Asymmetric RDT bits to CPUID.(EAX=07H,ECX=01H).ECX[bits 1:0] and CPUID leaves 27H and 28H. Added 256BITSGX to CPUID.(EAX=12H,ECX=00H).EAX[bit 12]. Updated CPUID.(EAX=1EH,ECX=00H). Updated CPUID.(EAX=24H,ECX=00H).EBX[bits 18:16] for vector length support.</li> <li>• Chapter 2: Removed footnote references to verify vector options in the opcode tables of instructions MOVRS, VSM4KEY4, and VSM4RNDS4. Updated pseudocode for instruction PBNDKB. Clarified the CPUID Feature Flag adding AND where multiple flags are required for the opcode tables of VSM4KEY4 and VSM4RNDS4.</li> <li>• Chapter 3: Clarified the CPUID Feature Flag adding AND where multiple flags are required for the opcode tables of T2RPMTLVW[Z0,Z1]RS[T1], TCONJTCMMIMFP16PS, TCONJTFFP16, TCVTROWD2PS, TCVTROWPS2BF16, TCVTROWPS2PH, TDP[B,H,BH,HB]F8PS, TILEMOVROW, TTCM[IM,RL]FP16PS, TDPBF16PS, TDPFP16PS, and TTMMULTF32PS.</li> <li>• Chapter 4: Added Section 4.5, "Use of RDT Tags by Other Features" and Section 4.6, "Asymmetrical Enumeration of Intel® RDT Features."</li> <li>• Chapter 5: Retitled Section 5.6 to "When Multiple RAO Memory Operations Are Combined" and clarified section content. Retitled Section 5.8.2 to "Event Handler."</li> <li>• Chapter 11: Updated Section 11.4.4, "XSAVE-Enabled Registers Group."</li> <li>• Added new Chapter 14, "Intel® Software Guard Extensions Feature Updates."</li> </ul>	March 2025

## CONTENTS

### CHAPTER 1

#### FUTURE INTEL® ARCHITECTURE INSTRUCTION EXTENSIONS AND FEATURES

1.1	About This Document . . . . .	1-1
1.2	DisplayFamily and DisplayModel for Future Processors . . . . .	1-1
1.3	Instruction Set Extensions and Feature Introduction in Intel® 64 and IA-32 Processors . . . . .	1-2
1.4	Detection of Future Instructions and Features . . . . .	1-4
	CPUID—CPU Identification . . . . .	1-4
1.5	Compressed Displacement (disp8*N) Support in EVEX . . . . .	1-58
1.6	bfloat16 Floating-Point Format . . . . .	1-59
1.7	FP8 Format . . . . .	1-60
1.7.1	Numeric Definition . . . . .	1-60
1.7.2	Floating-Point Rounding, Denormal Handling, NaN/Inf/Overflow Handling, and FP Exceptions . . . . .	1-60

### CHAPTER 2

#### INSTRUCTION SET REFERENCE, A-Z

2.1	Instruction Set Reference . . . . .	2-1
	AADD—Atomically Add . . . . .	2-2
	AAND—Atomically AND . . . . .	2-4
	AOR—Atomically OR . . . . .	2-6
	AXOR—Atomically XOR . . . . .	2-8
	MOVRS—Move Read-Shared Value . . . . .	2-10
	PBNKKB—Platform Bind Key to Binary Large Object . . . . .	2-14
	PCONFIG—Platform Configuration . . . . .	2-18
	PREFETCHRST2—Prefetch Data into Caches Using a Read-Shared Hint . . . . .	2-29
	RDMSR—Read From Model Specific Register . . . . .	2-30
	URDMSR—User Read from Model-Specific Register . . . . .	2-32
	UWRMSR—User Write to Model-Specific Register . . . . .	2-34
	VSM4KEY4—Perform Four Rounds of SM4 Key Expansion . . . . .	2-36
	VSM4RND54—Performs Four Rounds of SM4 Encryption . . . . .	2-39
	WRMSRNS—Non-Serializing Write to Model Specific Register . . . . .	2-41

### CHAPTER 3

#### INTEL® AMX INSTRUCTION SET REFERENCE, A-Z

3.1	Introduction . . . . .	3-1
3.1.1	Tile Architecture Details . . . . .	3-3
3.1.2	TMUL Architecture Details . . . . .	3-4
3.1.3	Handling of Tile Row and Column Limits . . . . .	3-5
3.1.4	Exceptions and Interrupts . . . . .	3-5
3.2	Operand Restrictions . . . . .	3-5
3.3	Implementation Parameters . . . . .	3-5
3.4	Helper Functions . . . . .	3-6
3.5	Notation . . . . .	3-10
3.6	Exception Classes . . . . .	3-10
3.7	Instruction Set Reference . . . . .	3-14
	T2RPNTLVW[Z0,Z1][,T1]—Tile Load to VNNI 16-Bit Format . . . . .	3-15
	T2RPNTLVW[Z0,Z1]RS[,T1]—Tile Load to VNNI 16-Bit Format Optimized for Read Only Shared Data . . . . .	3-18
	TCMMIMFP16PS/TCMMRFP16PS—Matrix Multiplication of Complex Tiles Accumulated into Packed Single Precision Tile . . . . .	3-20
	TCONJTTCMMIMFP16PS—Matrix Conjugate Transpose and Multiplication of Complex Tiles Accumulated into Packed Single Precision Tile . . . . .	3-23
	TCONJTFP16—Tile Conjugate Transpose FP16-Pair Complex Elements . . . . .	3-25
	TCVTROWD2PS—Tile Move Row and Convert INT32 to Single Precision . . . . .	3-26
	TCVTROWPS2BF16[H,L]—Tile Move Row and Convert FP32 Elements to BF16 Elements . . . . .	3-28
	TCVTROWPS2PH[H,L]—Tile Move Row and Convert Single Precision to FP16 . . . . .	3-31
	TDP[B,H,BH,HB]F8PS—Dot Product of FP8 Tiles Accumulated into Packed Single Precision Tile . . . . .	3-34



TILELOADDRS[,T1]—Load Tile Format Optimized for Read Only Shared Data . . . . .	3-37
TILEMOVROW—Tile Move Row . . . . .	3-38
TMMULTF32PS—Matrix Multiplication of TF32 Tiles into Packed Single Precision Tile . . . . .	3-40
TTCMM[IM,RL]FP16PS—Matrix Transpose and Multiplication of Complex Tiles Accumulated into Packed Single Precision Tile. . . . .	3-42
TTDPBF16PS—Dot Product and Transpose of BF16 Tiles Accumulated into Packed Single Precision Tile . . . . .	3-45
TTDFFP16PS—Dot Product and Transpose of FP16 Tiles Accumulated into Packed Single Precision Tile . . . . .	3-47
TTMULTF32PS—Matrix Transpose and Multiplication of TF32 Tiles into Packed Single Precision Tile . . . . .	3-49
TTRANPOSED—Matrix Transpose of 32-Bit Elements. . . . .	3-51

## CHAPTER 4

### INTEL® RESOURCE DIRECTOR TECHNOLOGY FEATURE UPDATES

4.1 Cache Bandwidth Allocation (CBA) . . . . .	4-1
4.1.1 Introduction to Cache Bandwidth Allocation. . . . .	4-1
4.1.2 Cache Bandwidth Allocation Enumeration . . . . .	4-1
4.1.3 Cache Bandwidth Allocation Configuration. . . . .	4-3
4.1.4 Cache Bandwidth Allocation Usage Considerations . . . . .	4-4
4.2 Memory Regions . . . . .	4-4
4.3 Region Aware Memory Bandwidth Monitoring (MBM) . . . . .	4-4
4.4 Region Aware Memory Bandwidth Allocation (MBA) . . . . .	4-5
4.5 Use of RDT Tags by Other Features . . . . .	4-5
4.6 Asymmetrical Enumeration of Intel® RDT Features . . . . .	4-6

## CHAPTER 5

### REMOTE ATOMIC OPERATIONS IN INTEL ARCHITECTURE

5.1 Introduction . . . . .	5-1
5.2 Instructions. . . . .	5-1
5.3 Alignment Requirements. . . . .	5-1
5.4 Memory Ordering. . . . .	5-2
5.5 Memory Type . . . . .	5-2
5.6 When Multiple RAO Memory Operations Are Combined . . . . .	5-2
5.7 Performance Expectations. . . . .	5-2
5.7.1 Interaction Between RAO and Other Accesses . . . . .	5-2
5.7.2 Updates of Contended Data. . . . .	5-3
5.7.3 Updates of Uncontended Data . . . . .	5-3
5.8 Examples . . . . .	5-4
5.8.1 Histogram . . . . .	5-4
5.8.2 Event Handler . . . . .	5-4

## CHAPTER 6

### TOTAL STORAGE ENCRYPTION IN INTEL ARCHITECTURE

6.1 Introduction . . . . .	6-1
6.1.1 Key Programming Overview . . . . .	6-1
6.1.1.1 Key Wrapping Support: PBNKDB . . . . .	6-1
6.1.2 Unwrapping and Hardware Key Programming Support: PCONFIG. . . . .	6-1
6.2 Enumeration . . . . .	6-1
6.2.1 CPUID Detection . . . . .	6-1
6.2.1.1 PCONFIG CPUID Leaf Extended to Support Total Storage Encryption . . . . .	6-1
6.2.2 Total Storage Encryption Capability MSR. . . . .	6-2
6.3 VMX Support. . . . .	6-2
6.3.1 Changes to VMCS Fields . . . . .	6-2
6.3.2 Changes to VMX Capability MSRs . . . . .	6-2
6.3.3 Changes to VM Entry . . . . .	6-2
6.4 Instruction Set . . . . .	6-2



## CHAPTER 7 USER-TIMER EVENTS AND INTERRUPTS

7.1	Enabling and Enumeration . . . . .	7-1
7.2	User Deadline . . . . .	7-1
7.3	User Timer: Architectural State . . . . .	7-2
7.4	Pending and Processing of User-Timer Events . . . . .	7-2
7.5	VMX Support . . . . .	7-2
7.5.1	VMCS Changes . . . . .	7-3
7.5.2	Changes to VMX Non-Root Operation . . . . .	7-3
7.5.2.1	Treatment of Accesses to the IA32_UINTR_TIMER MSR . . . . .	7-3
7.5.2.2	Treatment of User-Timer Events . . . . .	7-3
7.5.3	Changes to VM Entries . . . . .	7-3

## CHAPTER 8 APIC-TIMER VIRTUALIZATION

8.1	Guest-Timer Hardware . . . . .	8-1
8.1.1	Responding to Guest-Deadline Updates . . . . .	8-1
8.1.2	Guest-Timer Events . . . . .	8-2
8.2	VMCS Support . . . . .	8-2
8.2.1	New VMX Control . . . . .	8-2
8.2.2	New VMCS Fields . . . . .	8-2
8.3	Changes to VM Entries . . . . .	8-2
8.3.1	Checking VMX Controls . . . . .	8-2
8.3.2	Loading the Guest Deadline . . . . .	8-3
8.4	Changes to VMX Non-Root Operation . . . . .	8-3
8.4.1	Accesses to the IA32_TSC_DEADLINE MSR . . . . .	8-3
8.4.2	Processing of Guest-Timer Events . . . . .	8-3
8.5	Changes to VM Exits . . . . .	8-4

## CHAPTER 9 PROCESSOR TRACE TRIGGER TRACING

9.1	Processor Trace Trigger Tracing Overview . . . . .	9-1
9.1.1	Trigger Unit . . . . .	9-1
9.1.2	Trigger Input . . . . .	9-1
9.1.3	Trigger Actions . . . . .	9-2
9.1.4	Programming Considerations . . . . .	9-2
9.1.5	Trigger (TRIG) Packet . . . . .	9-2
9.2	MSR Changes . . . . .	9-4
9.2.1	IA32_RTIT_TRIGGERx_CFG . . . . .	9-4
9.2.2	IA32_PERFEVTSELx MSR Changes . . . . .	9-5
9.2.3	DR7 Changes . . . . .	9-6
9.2.4	IA32_RTIT_STATUS Changes . . . . .	9-6

## CHAPTER 10 MONITORLESS MWAIT

10.1	Using Monitorless MWAIT . . . . .	10-1
10.2	Enumeration . . . . .	10-1
10.3	Enabling . . . . .	10-2
10.4	Virtualization . . . . .	10-2
10.5	MWAIT Instruction Details . . . . .	10-2
	MWAIT—Monitor Wait . . . . .	10-3

## CHAPTER 11 ARCHITECTURAL PEBS

11.1	Enumeration . . . . .	11-1
11.1.1	IA32_PERF_CAPABILITIES . . . . .	11-1
11.1.2	IA32_MISC_ENABLE . . . . .	11-2

11.2	Behavior	11-2
11.2.1	Counters	11-2
11.2.2	Record Data	11-2
11.2.3	Programming PEBS	11-3
11.2.3.1	Programming Guidelines at Initialization Phase	11-3
11.2.3.2	Programming Guidelines at Runtime (e.g., Inside the PMI Interrupt Service Routine)	11-4
11.3	Model-Specific Registers (MSRs)	11-5
11.3.1	IA32_PEBS_BASE MSR	11-6
11.3.2	IA32_PEBS_INDEX MSR	11-6
11.3.3	IA32_PMC_GPn_CFG_C and IA32_PMC_FXm_CFG_C MSRs	11-7
11.3.4	Changes from Legacy PEBS	11-9
11.4	Records and Groups	11-10
11.4.1	Basic Group	11-10
11.4.1.1	Instruction Pointer	11-11
11.4.1.2	Applicable Counter	11-11
11.4.1.3	Time-Stamp Counter	11-12
11.4.1.4	Retire Latency	11-12
11.4.2	Auxiliary Group	11-12
11.4.2.1	Memory Access Address	11-13
11.4.3	General-Purpose Register Group	11-13
11.4.4	XSAVE-Enabled Registers Group	11-14
11.4.5	Last Branch Record Group	11-15
11.4.6	Performance Counters Group	11-16
11.4.7	Fragmented Records	11-17
11.5	Interactions with Other Processor Features	11-18
11.5.1	Virtual Machine Extension (VMX)	11-18
11.5.2	Intel® Secure Guard Extensions (Intel® SGX)	11-20
11.5.3	Intel® Trust Domain Extensions (Intel® TDX)	11-20
11.5.4	System Management Mode (SMM)	11-21
11.5.5	SMM-Transfer Monitor (STM)	11-21

## CHAPTER 12 MOVRS INSTRUCTIONS

## CHAPTER 13 VMX ENHANCEMENTS

13.1	VMCS Changes	13-1
13.1.1	New VMX Controls	13-1
13.1.2	New VMCS Fields	13-1
13.2	Changes to VM Entries	13-1
13.2.1	Host-State Checking	13-1
13.2.2	Guest-State Checking	13-1
13.2.3	Guest-State Loading	13-2
13.3	Changes to VM Exits	13-2
13.3.1	Saving Guest State	13-2
13.3.2	Loading Host State	13-2

## CHAPTER 14 INTEL® SOFTWARE GUARD EXTENSIONS FEATURE UPDATES

14.1	Enclave Instructions and Intel® SGX	14-1
14.2	Intel® SGX Resource Enumeration Leaves	14-1
14.3	Intel® SGX MSR Updates	14-1
14.4	Memory Accesses	14-3
14.5	Intel® SGX Data Structures	14-4
14.5.1	SGX Enclave Control Structure (SECS)	14-4
14.5.2	Attributes	14-4
14.5.3	Enclave Signature Structure (SIGSTRUCT)	14-5
14.5.4	EINIT Token Structure (EINITTOKEN)	14-6

14.5.5	REPORT2 (REPORT2) . . . . .	14-7
14.5.5.1	REPORT MAC STRUCTURE (REPORTMACSTRUCT) . . . . .	14-7
14.5.5.2	REPORT TYPE (REPORTTYPE) . . . . .	14-8
14.5.5.3	SGX TEEINFO (TEEINFO) . . . . .	14-8
14.5.6	REPORT2.REPORTMACSTRUCT.REPORTDATA . . . . .	14-9
14.6	Intel® SGX Instruction Syntax and Operation . . . . .	14-9
14.6.1	ENCLU Register Usage Summary . . . . .	14-9
14.6.2	Information and Error Codes . . . . .	14-9
14.6.3	Internal CREGs . . . . .	14-10
14.6.4	Intel® SGX Instructions Concurrency Tables . . . . .	14-11
14.7	Intel® SGX System Leaf Function Reference . . . . .	14-15
	EADD—Add a Page to an Uninitialized Enclave . . . . .	14-16
	ECREATE—Create an SECS page in the Enclave Page Cache . . . . .	14-21
	EEXTEND—Extend Uninitialized Enclave Measurement by 256 Bytes . . . . .	14-27
	EINIT—Initialize an Enclave for Execution . . . . .	14-31
	ELDB/ELDU/ELDBC/ELDUC—Load an EPC Page and Mark its State . . . . .	14-41
	EWB—Invalidate an EPC Page and Write out to Main Memory . . . . .	14-47
14.8	Intel® SGX User Leaf Function Reference . . . . .	14-52
	EGETKEY—Retrieves a Cryptographic Key . . . . .	14-53
	EREPORT—Create a Cryptographic Report of the Enclave . . . . .	14-65
	EREPORT2—Create a Cryptographic Report of the Enclave . . . . .	14-70

# TABLES

	PAGE
1-1	CPUID Signature Values of DisplayFamily_DisplayModel . . . . . 1-1
1-2	Recent Instruction Set Extensions / Features Introduction in Intel® 64 and IA-32 Processors . 1-2
1-3	Information Returned by CPUID Instruction . . . . . 1-5
1-4	Processor Type Field . . . . . 1-36
1-5	Feature Information Returned in the ECX Register . . . . . 1-38
1-6	More on Feature Information Returned in the EDX Register . . . . . 1-40
1-7	Encoding of CPUID Leaf 2 Descriptors . . . . . 1-42
1-8	Processor Brand String Returned with Pentium 4 Processor . . . . . 1-50
1-9	Mapping of Brand Indices; and Intel 64 and IA-32 Processor Brand Strings . . . . . 1-52
1-10	Compressed Displacement (DISP8*N) Affected by Embedded Broadcast . . . . . 1-58
1-11	EVEX DISP8*N for Instructions Not Affected by Embedded Broadcast . . . . . 1-58
1-12	FP8 Formats Numeric Definitions . . . . . 1-60
1-13	FP Numerical Handling of Converts . . . . . 1-61
2-1	Type Legacy-MOVRS Class Exception Conditions . . . . . 2-13
2-1	Bind Structure Format . . . . . 2-14
2-2	MKTME_KEY_PROGRAM_STRUCT Format . . . . . 2-18
2-3	TSE_KEY_PROGRAM_STRUCT Format . . . . . 2-20
2-4	TSE_KEY_PROGRAM_WRAPPED Control Input . . . . . 2-21
2-5	Bind Structure Format . . . . . 2-21
2-6	Format of the VM-Exit Instruction Information Field Used for URDMSR and UWRMSR . . . . . 2-33
2-7	MSRs Writeable by UWRMSR . . . . . 2-34
3-1	Intel® AMX Treatment of Denormal Inputs and Outputs . . . . . 3-5
3-2	Intel® AMX Exception Classes . . . . . 3-11
3-3	Valid Destination Tile Configurations . . . . . 3-15
3-4	Destination Tile Configurations . . . . . 3-19
4-1	Cache Bandwidth Allocation (CBA) MSRs . . . . . 4-3
4-2	Asymmetrical Enumeration . . . . . 4-6
4-3	Asymmetrical CPUID Leaves . . . . . 4-6
5-1	RAO Instructions . . . . . 5-1
6-1	TSE Capability MSR Fields . . . . . 6-2
9-1	Supported Trigger Inputs . . . . . 9-1
9-2	Trigger Actions . . . . . 9-2
9-3	ICNT on Multiple Trigger Events . . . . . 9-3
9-4	TRIG Packet Definition . . . . . 9-4
9-5	IA32_RTIT_TRIGGERx_CFG MSR Definition . . . . . 9-5
9-6	IA32_RTIT_STATUS MSR Definition . . . . . 9-6
10-1	MWAIT Extension Register (ECX) . . . . . 10-4
10-2	MWAIT Hints Register (EAX) . . . . . 10-4
11-1	Architectural PEBS Configuration Locations . . . . . 11-3
11-2	Architectural PEBS MSRs . . . . . 11-5
11-3	IA32_PEBS_BASE MSR . . . . . 11-6
11-4	IA32_PEBS_INDEX MSR . . . . . 11-7
11-5	IA32_PMC_GPn_CFG_C and IA32_PMC_FXm_CFG_C MSRs . . . . . 11-8
11-6	Basic Group Fields . . . . . 11-10
11-7	Auxiliary Group Fields . . . . . 11-12
11-8	General-Purpose Register Group Fields . . . . . 11-13
11-9	XSAVE-Enabled Registers (XER) Group Fields and Sizes . . . . . 11-14
11-10	Last Branch Record Group Fields . . . . . 11-15
11-11	Counter Group Details . . . . . 11-16
11-12	PEBS VMCS Fields . . . . . 11-18
14-1	Supervisor and User Mode Enclave Instruction Leaf Function in Long-Form of 256-bit SGX . . 14-1
14-2	IA-32 Architectural MSR Updates for Intel® SGX . . . . . 14-2
14-3	List of Implicit and Explicit Memory Access by Intel® SGX Enclave Instructions . . . . . 14-3
14-4	Layout of ATTRIBUTES Structure . . . . . 14-4
14-5	Layout of Enclave Signature Structure (SIGSTRUCT) . . . . . 14-5



14-6	Layout of EINIT Token (EINITTOKEN) . . . . .	14-6
14-7	Layout of REPORT2. . . . .	14-7
14-8	Layout of REPORTMACSTRUCT . . . . .	14-7
14-9	Layout of REPORT2. . . . .	14-8
14-10	Layout of REPORTMACSTRUCT . . . . .	14-8
14-11	Register Usage of Unprivileged Enclave Instruction Leaf Functions . . . . .	14-9
14-12	Error or Information Codes for Intel® SGX Instructions . . . . .	14-9
14-13	List of Internal CREG . . . . .	14-10
14-14	Base Concurrency Restrictions . . . . .	14-11
14-15	Additional Concurrency Restrictions . . . . .	14-13
14-16	Base Concurrency Restrictions of EADD. . . . .	14-16
14-17	Additional Concurrency Restrictions of EADD . . . . .	14-17
14-18	Base Concurrency Restrictions of ECREATE . . . . .	14-21
14-19	Additional Concurrency Restrictions of ECREATE. . . . .	14-22
14-20	Base Concurrency Restrictions of EEXTEND . . . . .	14-27
14-21	Additional Concurrency Restrictions of EEXTEND . . . . .	14-28
14-22	EINIT Return Value in RAX . . . . .	14-32
14-23	Base Concurrency Restrictions of EINIT. . . . .	14-33
14-24	Additional Concurrency Restrictions of EINIT . . . . .	14-33
14-25	ELDB/ELDU/ELDBC/ELBUC Return Value in RAX . . . . .	14-41
14-26	Base Concurrency Restrictions of ELDB/ELDU/ELDBC/ELBUC . . . . .	14-42
14-27	Additional Concurrency Restrictions of ELDB/ELDU/ELDBC/ELBUC . . . . .	14-42
14-28	EWB Return Value in RAX . . . . .	14-47
14-29	Base Concurrency Restrictions of EWB . . . . .	14-47
14-30	Additional Concurrency Restrictions of EWB. . . . .	14-47
14-31	Key Derivation . . . . .	14-54
14-32	EGETKEY Return Value in RAX . . . . .	14-54
14-33	Base Concurrency Restrictions of EGETKEY . . . . .	14-55
14-34	Additional Concurrency Restrictions of EGETKEY. . . . .	14-55
14-35	Base Concurrency Restrictions of EREPORT . . . . .	14-66
14-36	Additional Concurrency Restrictions of EREPORT . . . . .	14-66
14-37	Base Concurrency Restrictions of EREPORT2 . . . . .	14-71
14-38	Additional Concurrency Restrictions of EREPORT2. . . . .	14-71

## FIGURES

	PAGE
Figure 1-1. Version Information Returned by CPUID in EAX . . . . .	1-36
Figure 1-2. Feature Information Returned in the ECX Register . . . . .	1-38
Figure 1-3. Feature Information Returned in the EDX Register . . . . .	1-40
Figure 1-4. Determination of Support for the Processor Brand String . . . . .	1-50
Figure 1-5. Algorithm for Extracting Maximum Processor Frequency . . . . .	1-51
Figure 1-6. Comparison of BF16 to FP16 and FP32 . . . . .	1-59
Figure 3-1. Intel® AMX Architecture . . . . .	3-2
Figure 3-2. The TMUL Unit . . . . .	3-3
Figure 3-3. Matrix Multiply C+= A*B . . . . .	3-4
Figure 4-1. CPUID.(EAS=10H, ECX=5H), CBA Feature Details Identification. . . . .	4-2
Figure 4-2. IA32_QoS_Core_BW_Thrtl_n MSR Definition . . . . .	4-4
Figure 4-3. Region Aware Memory Bandwidth Allocation (MBA) . . . . .	4-5
Figure 9-1. Layout of the IA32_PERFEVTSELx MSR . . . . .	9-6
Figure 11-1. Example PEBS Record . . . . .	11-5
Figure 11-2. PEBS Record Format . . . . .	11-10
Figure 11-3. Bit Mapping of Applicable Counters in the PEBS Record . . . . .	11-11
Figure 11-4. Example of a Fragmented Record . . . . .	11-17
Figure 11-5. EPT Page Boundary Example with Included Padding . . . . .	11-18
Figure 11-6. Guest-Only PEBS: Diagram of Interactions Across Entities. . . . .	11-19
Figure 11-7. System-Wide PEBS: Diagram of Interactions Across Entities . . . . .	11-20
Figure 14-1. Relationships Between SECS, SIGSTRUCT, and EINITOKEN . . . . .	14-31



# CHAPTER 1

## FUTURE INTEL® ARCHITECTURE INSTRUCTION EXTENSIONS AND FEATURES

### 1.1 ABOUT THIS DOCUMENT

This document describes the software programming interfaces of Intel® architecture instruction extensions and features which may be included in future Intel processor generations. Intel does not guarantee the availability of these interfaces and features in any future product.

The instruction set extensions cover a diverse range of application domains and programming usages. The 512-bit SIMD vector SIMD extensions, referred to as Intel® Advanced Vector Extensions 512 (Intel® AVX-512) instructions, deliver comprehensive set of functionality and higher performance than Intel® Advanced Vector Extensions (Intel® AVX) and Intel® Advanced Vector Extensions 2 (Intel® AVX2) instructions. Intel AVX, Intel AVX2, and many Intel AVX-512 instructions are covered in the Intel® 64 and IA-32 Architectures Software Developer's Manual. The reader can refer to them for basic and more background information related to various features referenced in this document.

The base of the 512-bit SIMD instruction extensions are referred to as Intel AVX-512 Foundation instructions. They include extensions of the Intel AVX and Intel AVX2 family of SIMD instructions but are encoded using a new encoding scheme with support for 512-bit vector registers, up to 32 vector registers in 64-bit mode, and conditional processing using opmask registers.

Chapter 2 is an instruction set reference, providing details on new instructions.

Chapter 3 describes the Intel® Advanced Matrix Extensions (Intel® AMX).

Chapter 4 describes Intel® Resource Director Technology feature updates.

Chapter 5 describes Remote Atomic Operations (RAO) in Intel architecture.

Chapter 6 describes Total Storage Encryption (TSE) in Intel architecture.

Chapter 7 describes an architectural feature called user-timer events.

Chapter 8 describes a VMX extension called APIC-timer virtualization.

Chapter 9 describes the Intel Processor Trace Trigger Tracing feature.

Chapter 10 describes the monitorless MWAIT feature.

Chapter 11 describes Architectural PEBS.

Chapter 12 provides a brief introduction to the MOVRS instructions.

### 1.2 DISPLAYFAMILY AND DISPLAYMODEL FOR FUTURE PROCESSORS

Table 1-1 lists the signature values of DisplayFamily and DisplayModel for future processor families discussed in this document.

**Table 1-1. CPUID Signature Values of DisplayFamily\_DisplayModel**

DisplayFamily_DisplayModel	Processor Families/Processor Number Series
06_B6H	Future processors based on Grand Ridge microarchitecture.
06_ADH, 06_AEH	Future processors based on Granite Rapids microarchitecture.
06_AFH	Future processors based on Sierra Forest microarchitecture.
06_B5H	Future processors supporting Arrow Lake U performance hybrid architecture.
06_C5H, 06_C6H	Future processors supporting Arrow Lake performance hybrid architecture.
06_BDH	Future processors supporting Lunar Lake performance hybrid architecture.
06_DDH	Future processors based on Clearwater Forest microarchitecture.



**Table 1-1. CPUID Signature Values of DisplayFamily\_DisplayModel (Continued)**

DisplayFamily_DisplayModel	Processor Families/Processor Number Series
06_CCH	Future processors supporting Panther Lake performance hybrid architecture.
13_01H	Future processors based on Diamond Rapids Server microarchitecture.

### 1.3 INSTRUCTION SET EXTENSIONS AND FEATURE INTRODUCTION IN INTEL® 64 AND IA-32 PROCESSORS

Recent instruction set extensions and features are listed in Table 1-2. Within these groups, most instructions and features are collected into functional subgroups.

**Table 1-2. Recent Instruction Set Extensions / Features Introduction in Intel® 64 and IA-32 Processors<sup>1</sup>**

Instruction Set Architecture / Feature	Introduction
AVX512_VP2INTERSECT	Tiger Lake (not currently supported in any other processors)
Intel® TSX Suspend Load Address Tracking (TSXLDTRK)	Sapphire Rapids
Intel® Advanced Matrix Extensions (Intel® AMX) Includes CPUID Leaf 1EH, "TMUL Information Main Leaf," and CPUID bits AMX-BF16, AMX-TILE, and AMX-INT8.	Sapphire Rapids
User Interrupts (UINTR)	Sapphire Rapids, Sierra Forest, Grand Ridge, Arrow Lake, Lunar Lake
Intel® Trust Domain Extensions (Intel® TDX) <sup>2</sup>	Emerald Rapids
Linear Address Masking (LAM)	Sierra Forest, Grand Ridge, Arrow Lake, Lunar Lake, Diamond Rapids
IPI Virtualization	Sapphire Rapids, Sierra Forest, Grand Ridge, Arrow Lake, Lunar Lake
RAO-INT	Future processors
PREFETCHIT0/1	Granite Rapids, Clearwater Forest
AMX-FP16	Granite Rapids
CMPPCXADD	Sierra Forest, Grand Ridge, Arrow Lake, Lunar Lake, Diamond Rapids
AVX-IFMA	Sierra Forest, Grand Ridge, Arrow Lake, Lunar Lake, Diamond Rapids
AVX-NE-CONVERT	Sierra Forest, Grand Ridge, Arrow Lake, Lunar Lake, Diamond Rapids
AVX-VNNI-INT8	Sierra Forest, Grand Ridge, Arrow Lake, Lunar Lake, Diamond Rapids
RDMSRLIST/WRMSRLIST/WRMSRNS	Sierra Forest, Grand Ridge, Panther Lake, Diamond Rapids
Linear Address Space Separation (LASS)	Sierra Forest, Grand Ridge, Arrow Lake, Lunar Lake, Diamond Rapids
Virtualization of guest accesses to IA32_SPEC_CTRL	Sapphire Rapids, Sierra Forest, Grand Ridge, Panther Lake, Diamond Rapids
UC-Lock Disable Causes #AC	Sierra Forest, Grand Ridge
LBR Event Logging	Sierra Forest, Grand Ridge, Arrow Lake S (06_C6H), Lunar Lake, Diamond Rapids
AMX-COMPLEX	Granite Rapids D (06_AEH), Diamond Rapids
AVX-VNNI-INT16	Arrow Lake S (06_C6H), Lunar Lake, Clearwater Forest, Diamond Rapids
SHA512	Arrow Lake S (06_C6H), Lunar Lake, Clearwater Forest, Diamond Rapids
SM3	Arrow Lake S (06_C6H), Lunar Lake, Clearwater Forest, Diamond Rapids

**Table 1-2. Recent Instruction Set Extensions / Features Introduction in Intel® 64 and IA-32**

Instruction Set Architecture / Feature	Introduction
SM4 (VEX)	Arrow Lake S (06_C6H), Lunar Lake, Clearwater Forest, Diamond Rapids
SM4 (EVEX)	Diamond Rapids
UIRET flexibly updates UIF	Sierra Forest, Grand Ridge, Arrow Lake, Lunar Lake, Diamond Rapids
Total Storage Encryption (TSE) and the PBNDKB instruction	Future processors
Intel® Advanced Vector Extensions 10 Version 1 (Intel® AVX10.1) <sup>3</sup>	Granite Rapids
URDMSR and UWRMSR instructions	Clearwater Forest, Diamond Rapids
Flexible Return and Event Delivery (FRED) and the LKGS instruction <sup>4</sup>	Panther Lake, Clearwater Forest, Diamond Rapids
NMI-Source Reporting <sup>4</sup>	Panther Lake, Clearwater Forest, Diamond Rapids
User-Timer Events and Interrupts	Clearwater Forest
APIC-Timer Virtualization	Clearwater Forest
Management of IA32_SPEC_CTRL by VMX transitions	Clearwater Forest, Diamond Rapids
Intel Processor Trace Trigger Tracing	Clearwater Forest
Monitorless MWAIT	Clearwater Forest
Intel® Advanced Performance Extensions (Intel® APX) <sup>5</sup>	Diamond Rapids
Intel® Advanced Vector Extensions 10 Version 2 (Intel® AVX10.2) <sup>6</sup>	Diamond Rapids
Architectural PEBS	Panther Lake, Clearwater Forest, Diamond Rapids
Immediate encodings for RDMSR and WRMSRNS	Clearwater Forest
MOVRS and the PREFETCHRST2 instruction	Diamond Rapids
AMX-MOVRS	Diamond Rapids
AMX-AVX512	Diamond Rapids
AMX-FP8	Diamond Rapids
AMX-TF32	Diamond Rapids
AMX-TRANSPOSE	Diamond Rapids
Intel® RDT Region Aware Memory Bandwidth Allocation <sup>7</sup>	Diamond Rapids
Intel® RDT Allocation Asymmetric Enumeration	Panther Lake, Clearwater Forest, Diamond Rapids
Intel® RDT Monitoring Asymmetric Enumeration	Panther Lake, Clearwater Forest, Diamond Rapids

**NOTES:**

1. Visit for Intel® product specifications, features and compatibility quick reference guide, and code name decoder, visit: <https://ark.intel.com/content/www/us/en/ark.html>.
2. Details on Intel® Trust Domain Extensions can be found here: <https://www.intel.com/content/www/us/en/developer/articles/technical/intel-trust-domain-extensions.html>.
3. Details on Intel® Advanced Vector Extensions 10 Version 1 can be found here: <https://cdrdv2.intel.com/v1/dl/getContent/784267>.
4. Details on the LKGS (load into IA32\_KERNEL\_GS\_BASE) instruction, NMI-source reporting, and Flexible Return and Event Delivery can be found here: <https://cdrdv2.intel.com/v1/dl/getContent/795033>.
5. Details on Intel® Advanced Performance Extensions can be found here: <https://cdrdv2.intel.com/v1/dl/getContent/784266>.
6. Details on Intel® Advanced Vector Extensions 10 Version 2 can be found here: <https://cdrdv2.intel.com/v1/dl/getContent/828965>.
7. Details on Intel® RDT Region Aware Memory Bandwidth Allocation can be found here: <https://cdrdv2.intel.com/v1/dl/getContent/789566>.

## 1.4 DETECTION OF FUTURE INSTRUCTIONS AND FEATURES

Future instructions and features are enumerated by a CPUID feature flag; details can be found in Table 1-3.

### CPUID—CPU Identification

Opcode	Instruction	64-Bit Mode	Compat/ Leg Mode	Description
0F A2	CPUID	Valid	Valid	Returns processor identification and feature information to the EAX, EBX, ECX, and EDX registers, as determined by input entered in EAX (in some cases, ECX as well).

#### Description

The ID flag (bit 21) in the EFLAGS register indicates support for the CPUID instruction. If a software procedure can set and clear this flag, the processor executing the procedure supports the CPUID instruction. This instruction operates the same in non-64-bit modes and 64-bit mode.

CPUID returns processor identification and feature information in the EAX, EBX, ECX, and EDX registers.<sup>1</sup> The instruction's output is dependent on the contents of the EAX register upon execution (in some cases, ECX as well). For example, the following pseudocode loads EAX with 00H and causes CPUID to return a Maximum Return Value and the Vendor Identification String in the appropriate registers:

```
MOV EAX, 00H
CPUID
```

Table 1-3 shows information returned, depending on the initial value loaded into the EAX register.

Two types of information are returned: basic and extended function information. If a value is entered for CPUID.EAX is invalid for a particular processor, the data for the highest basic information leaf is returned. For example, using the Intel Core 2 Duo E6850 processor, the following is true:

```
CPUID.EAX = 05H (* Returns MONITOR/MWAIT leaf. *)
CPUID.EAX = 0AH (* Returns Architectural Performance Monitoring leaf. *)
CPUID.EAX = 0BH (* INVALID: Returns the same information as CPUID.EAX = 0AH. *)2
CPUID.EAX = 1FH (* Returns V2 Extended Topology Enumeration leaf. *)2
CPUID.EAX = 80000008H (* Returns virtual/physical address size data. *)
CPUID.EAX = 8000000AH (* INVALID: Returns same information as CPUID.EAX = 0AH. *)
```

When CPUID returns the highest basic leaf information as a result of an invalid input EAX value, any dependence on input ECX value in the basic leaf is honored.

CPUID can be executed at any privilege level to serialize instruction execution. Serializing instruction execution guarantees that any modifications to flags, registers, and memory for previous instructions are completed before the next instruction is fetched and executed.

#### See also:

"Serializing Instructions" in Chapter 10, "Multiple-Processor Management," in the Intel® 64 and IA-32 Architectures Software Developer's Manual, Volume 3A.

"Caching Translation Information" in Chapter 5, "Paging," in the Intel® 64 and IA-32 Architectures Software Developer's Manual, Volume 3A.

1. On Intel 64 processors, CPUID clears the high 32 bits of the RAX/RBX/RX/RDX registers in all modes.
2. CPUID leaf 1FH is a preferred superset to leaf 0BH. Intel recommends first checking for the existence of CPUID leaf 1FH before using leaf 0BH.

**Table 1-3. Information Returned by CPUID Instruction**

Initial EAX Value	Information Provided about the Processor	
Basic CPUID Information		
0H	EAX EBX ECX EDX	Maximum Input Value for Basic CPUID Information. "Genu" "ntel" "inel"
01H	EAX EBX ECX EDX	Version Information: Type, Family, Model, and Stepping ID (see Figure 1-1). Bits 7-0: Brand Index. Bits 15-8: CLFLUSH line size (Value * 8 = cache line size in bytes). Bits 23-16: Maximum number of addressable IDs for logical processors in this physical package.* Bits 31-24: Initial APIC ID.**  ECX Feature Information (see Figure 1-2 and Table 1-5). EDX Feature Information (see Figure 1-3 and Table 1-6).  <b>NOTES:</b> * The nearest power-of-2 integer that is not smaller than EBX[23:16] is the maximum number of unique initial APIC IDs reserved for addressing different logical processors in a physical package. ** The 8-bit initial APIC ID in EBX[31:24] is replaced by the 32-bit x2APIC ID, available in Leaf 0BH and Leaf 1FH.
02H	EAX EBX ECX EDX	Cache and TLB Information (see Table 1-7). Cache and TLB Information. Cache and TLB Information. Cache and TLB Information.
03H	EAX EBX ECX EDX	Reserved. Reserved. Bits 00-31 of 96 bit processor serial number. (Available in Pentium III processor only; otherwise, the value in this register is reserved.) Bits 32-63 of 96 bit processor serial number. (Available in Pentium III processor only; otherwise, the value in this register is reserved.)  <b>NOTES:</b> Processor serial number (PSN) is not supported in the Pentium 4 processor or later. On all models, use the PSN flag (returned using CPUID) to check for PSN support before accessing the feature.
CPUID leaves > 3 < 80000000 are visible only when IA32_MISC_ENABLES.BOOT_NT4[bit 22] = 0 (default)		
Deterministic Cache Parameters Leaf (Initial EAX Value = 04H)		
04H	EAX	<b>NOTES:</b> Leaf 04H output depends on the initial value in ECX. See also: "INPUT EAX = 4: Returns Deterministic Cache Parameters for each level" on page 1-46.  Bits 4-0: Cache Type Field 0 = Null - No more caches. 1 = Data Cache. 2 = Instruction Cache. 3 = Unified Cache. 4-31 = Reserved.  Bits 7-5: Cache Level (starts at 1). Bits 8: Self Initializing cache level (does not need SW initialization). Bits 9: Fully Associative cache.

**Table 1-3. Information Returned by CPUID Instruction (Continued)**

Initial EAX Value	Information Provided about the Processor	
	<p>EBX</p> <p>ECX</p> <p>EDX</p>	<p>Bits 13-10: Reserved.</p> <p>Bits 25-14: Maximum number of addressable IDs for logical processors sharing this cache.*, **</p> <p>Bits 31-26: Maximum number of addressable IDs for processor cores in the physical package.*, ***, ****</p> <p>Bits 11-00: L = System Coherency Line Size.*</p> <p>Bits 21-12: P = Physical Line partitions.*</p> <p>Bits 31-22: W = Ways of associativity.*</p> <p>Bits 31-00: S = Number of Sets.*</p> <p>Bit 0: WBINVD/INVD behavior on lower level caches.</p> <p>Bit 10: Write-Back Invalidate/Invalidate.</p> <p>0 = WBINVD/INVD from threads sharing this cache acts upon lower level caches for threads sharing this cache.</p> <p>1 = WBINVD/INVD is not guaranteed to act upon lower level caches of non-originating threads sharing this cache.</p> <p>Bit 1: Cache Inclusiveness.</p> <p>0 = Cache is not inclusive of lower cache levels.</p> <p>1 = Cache is inclusive of lower cache levels.</p> <p>Bit 2: Complex cache indexing.</p> <p>0 = Direct mapped cache.</p> <p>1 = A complex function is used to index the cache, potentially using all address bits.</p> <p>Bits 31-03: Reserved = 0.</p> <p><b>NOTES:</b></p> <p>* Add one to the return value to get the result.</p> <p>** The nearest power-of-2 integer that is not smaller than (1 + EAX[25:14]) is the number of unique initial APIC IDs reserved for addressing different logical processors sharing this cache.</p> <p>*** The nearest power-of-2 integer that is not smaller than (1 + EAX[31:26]) is the number of unique Core_IDs reserved for addressing different processor cores in a physical package. Core ID is a subset of bits of the initial APIC ID.</p> <p>**** The returned value is constant for valid initial values in ECX. Valid ECX values start from 0.</p>
MONITOR/MWAIT Leaf (Initial EAX Value = 05H)		
05H	<p>EAX</p> <p>EBX</p> <p>ECX</p>	<p>Bits 15-00: Smallest monitor-line size in bytes (default is processor’s monitor granularity). Bits 31-16: Reserved = 0.</p> <p>Bits 15-00: Largest monitor-line size in bytes (default is processor’s monitor granularity). Bits 31-16: Reserved = 0.</p> <p>Bit 00: Enumeration of Monitor-Mwait extensions (beyond EAX and EBX registers) supported.</p> <p>Bit 01: Supports treating interrupts as break-event for MWAIT, even when interrupts are disabled.</p> <p>Bit 02: Reserved.</p> <p>Bit 03: MONITORLESS_MWAIT. If 1, monitorless MWAIT is supported.</p> <p>Bits 31-04: Reserved.</p>

**Table 1-3. Information Returned by CPUID Instruction (Continued)**

Initial EAX Value	Information Provided about the Processor	
	EDX	Bits 03-00: Number of C0* sub C-states supported using MWAIT. Bits 07-04: Number of C1* sub C-states supported using MWAIT. Bits 11-08: Number of C2* sub C-states supported using MWAIT. Bits 15-12: Number of C3* sub C-states supported using MWAIT. Bits 19-16: Number of C4* sub C-states supported using MWAIT. Bits 23-20: Number of C5* sub C-states supported using MWAIT. Bits 27-24: Number of C6* sub C-states supported using MWAIT. Bits 31-28: Number of C7* sub C-states supported using MWAIT. <b>NOTE:</b> * The definition of C0 through C7 states for MWAIT extension are processor-specific C-states, not ACPI C-states.
Thermal and Power Management Leaf (Initial EAX Value = 06H)		
06H	EAX	Bit 00: Digital temperature sensor is supported if set. Bit 01: Intel® Turbo Boost Technology Available (see description of IA32_MISC_ENABLE[38]). Bit 02: ARAT. APIC-Timer-always-running feature is supported if set. Bit 03: Reserved. Bit 04: PLN. Power limit notification controls are supported if set. Bit 05: ECMD. Clock modulation duty cycle extension is supported if set. Bit 06: PTM. Package thermal management is supported if set. Bit 07: HWP. HWP base registers (IA32_PM_ENABLE[bit 0], IA32_HWP_CAPABILITIES, IA32_HWP_REQUEST, IA32_HWP_STATUS) are supported if set. Bit 08: HWP_Notification. IA32_HWP_INTERRUPT MSR is supported if set. Bit 09: HWP_Activity_Window. IA32_HWP_REQUEST[bits 41:32] is supported if set. Bit 10: HWP_Energy_Performance_Preference. IA32_HWP_REQUEST[bits 31:24] is supported if set. Bit 11: HWP_Package_Level_Request. IA32_HWP_REQUEST_PKG MSR is supported if set. Bit 12: Reserved. Bit 13: HDC. HDC base registers IA32_PKG_HDC_CTL, IA32_PM_CTL1, IA32_THREAD_STALL MSRs are supported if set. Bit 14: Intel® Turbo Boost Max Technology 3.0 available. Bit 15: HWP Capabilities. Highest Performance change is supported if set. Bit 16: HWP PECC override is supported if set. Bit 17: Flexible HWP is supported if set. Bit 18: Fast access mode, low latency, and posted IA32_HWP_REQUEST MSR are supported if set. Bit 19: HW_FEEDBACK. IA32_HW_FEEDBACK_PTR, IA32_HW_FEEDBACK_CONFIG, IA32_PACKAGE_THERM_STATUS bit 26 and IA32_PACKAGE_THERM_INTERRUPT bit 25 are supported if set. Bit 20: Ignoring Idle Logical Processor HWP request is supported if set. Bit 21: Reserved. Bit 22: HWP Control MSR Support. The IA32_HWP_CTL MSR is supported if set. Bit 23: Intel® Thread Director supported if set. IA32_HW_FEEDBACK_CHAR and IA32_HW_FEEDBACK_THREAD_CONFIG MSRs are supported if set. Bit 24: IA32_THERM_INTERRUPT MSR bit 25 is supported if set. Bits 31-25: Reserved.
	EBX	Bits 03-00: Number of Interrupt Thresholds in Digital Thermal Sensor. Bits 31-04: Reserved.

**Table 1-3. Information Returned by CPUID Instruction (Continued)**

Initial EAX Value	Information Provided about the Processor
	<p>ECX Bit 00: Hardware Coordination Feedback Capability (Presence of IA32_MPERF and IA32_APERF). The capability to provide a measure of delivered processor performance (since last reset of the counters), as a percentage of the expected processor performance when running at the TSC frequency. Bits 02-01: Reserved = 0. Bit 03: The processor supports performance-energy bias preference if CPUID.06H:ECX.SETBH[bit 3] is set, and it also implies the presence of the IA32_ENERGY_PERF_BIAS MSR (MSR address 1BOH). Bits 07-04: Reserved = 0. Bits 15-08: Number of Intel® Thread Director classes supported by the processor. Information for that many classes is written into the Intel Thread Director Table by the hardware. Bits 31-16: Reserved = 0.</p> <p>EDX Bits 7-0: Bitmap of supported hardware feedback interface capabilities. 0 = When set to 1, indicates support for performance capability reporting. 1 = When set to 1, indicates support for energy efficiency capability reporting. 2-7 = Reserved. Bits 11-08: Enumerates the size of the hardware feedback interface structure in number of 4 KB pages; add one to the return value to get the result. Bits 31-16: Index (starting at 0) of this logical processor’s row in the hardware feedback interface structure. Note that on some parts the index may be same for multiple logical processors. On some parts the indices may not be contiguous, i.e., there may be unused rows in the hardware feedback interface structure.</p> <p><b>NOTE:</b> Bits 0 and 1 will always be set together.</p>
Structured Extended Feature Flags Enumeration Main Leaf (Initial EAX Value = 07H, ECX = 0)	
07H	<p><b>NOTE:</b> If ECX contains an invalid sub leaf index, EAX/EBX/ECX/EDX return 0. Sub-leaf index n is invalid if n exceeds the value that sub-leaf 0 returns in EAX.</p> <p>EAX Bits 31-00: Reports the maximum number sub-leaves that are supported in leaf 07H.</p> <p>EBX Bit 00: FSGSBASE. Supports RDFSBASE/RDGSBASE/WRFSBASE/WRGSBASE if 1. Bit 01: IA32_TSC_ADJUST MSR is supported if 1. Bit 02: SGX. Bit 03: BMI1. Bit 04: HLE. Bit 05: AVX2. Supports Intel® Advanced Vector Extensions 2 (Intel® AVX2) if 1. Bit 06: FDP_EXCPTN_ONLY. x87 FPU Data Pointer updated only on x87 exceptions if 1. Bit 07: SMEP. Supports Supervisor Mode Execution Protection if 1. Bit 08: BMI2. Bit 09: Supports Enhanced REP MOVSB/STOSB if 1. Bit 10: INVPCID. Bit 11: RTM. Bit 12: RDT-M. Supports Intel® Resource Director Technology (Intel® RDT) Monitoring capability if 1. Bit 13: Deprecates FPU CS and FPU DS values if 1. Bit 14: Intel® Memory Protection Extensions. Bit 15: RDT-A. Supports Intel® Resource Director Technology (Intel® RDT) Allocation capability if 1. Bit 16: AVX512F. Bit 17: AVX512DQ. Bit 18: RDSEED. Bit 19: ADX. Bit 20: SMAP. Bit 21: AVX512_IFMA. Bit 22: Reserved. Bit 23: CLFLUSHOPT.</p>

**Table 1-3. Information Returned by CPUID Instruction (Continued)**

Initial EAX Value	Information Provided about the Processor
	<p>Bit 24: CLWB.                      Bit 25: Intel Processor Trace.                      Bit 26: AVX512PF. (Intel® Xeon Phi™ only.)                      Bit 27: AVX512ER. (Intel® Xeon Phi™ only.)                      Bit 28: AVX512CD.                      Bit 29: SHA.                      Bit 30: AVX512BW.                      Bit 31: AVX512VL.</p> <p>ECX</p> <p>Bit 00: PREFETCHWT1. (Intel® Xeon Phi™ only.)                      Bit 01: AVX512_VBMI.                      Bit 02: UMIP. Supports user-mode instruction prevention if 1.                      Bit 03: PKU. Supports protection keys for user-mode pages if 1.                      Bit 04: OSPKE. If 1, OS has set CR4.PKE to enable protection keys (and the RDPKRU/WRPKRU instructions).                      Bit 05: WAITPKG.                      Bit 06: AVX512_VBMI2.                      Bit 07: CET_SS. Supports CET shadow stack features if 1. Processors that set this bit define bits 1:0 of the IA32_U_CET and IA32_S_CET MSRs. Enumerates support for the following MSRs: IA32_INTERRUPT_SPP_TABLE_ADDR, IA32_PL3_SSP, IA32_PL2_SSP, IA32_PL1_SSP, and IA32_PL0_SSP.                      Bit 08: GFNI.                      Bit 09: VAES.                      Bit 10: VPCLMULQDQ.                      Bit 11: AVX512_VNNI.                      Bit 12: AVX512_BITALG.                      Bit 13: TME_EN. If 1, the following MSRs are supported: IA32_TME_CAPABILITY, IA32_TME_ACTIVATE, IA32_TME_EXCLUDE_MASK, and IA32_TME_EXCLUDE_BASE.                      Bit 14: AVX512_VPOPCNTDQ.                      Bit 15: Reserved.                      Bit 16: LA57. Supports 57-bit linear addresses and five-level paging if 1.                      Bits 21-17: The value of MAWAU used by the BNDLDX and BNDSTX instructions in 64-bit mode.                      Bit 22: RDPID and IA32_TSC_AUX are available if 1.                      Bit 23: KL. Supports Key Locker if 1.                      Bit 24: BUS_LOCK_DETECT. If 1, indicates support for bus lock debug exceptions.                      Bit 25: CLDEMOTE. Supports cache line demote if 1.                      Bit 26: Reserved.                      Bit 27: MOVDIRI. Supports MOVDIRI if 1.                      Bit 28: MOVDIR64B. Supports MOVDIR64B if 1.                      Bit 29: ENQCMD. Supports Enqueue Stores if 1.                      Bit 30: SGX_LC. Supports SGX Launch Configuration if 1.                      Bit 31: PKS. Supports protection keys for supervisor-mode pages if 1.</p>



**Table 1-3. Information Returned by CPUID Instruction (Continued)**

Initial EAX Value	Information Provided about the Processor
	<p>EDX</p> <p>Bit 00: Reserved.                      Bit 01: SGX-KEYS. If 1, Attestation Services for Intel® SGX is supported.                      Bit 02: AVX512_4VNNIW. (Intel® Xeon Phi™ only.)                      Bit 03: AVX512_4FMAPS. (Intel® Xeon Phi™ only.)                      Bit 04: Fast Short REP MOV.                      Bit 05: UINTR. If 1, the processor supports user interrupts.                      Bits 07-06: Reserved.                      Bit 08: AVX512_VP2INTERSECT.                      Bit 09: SRBDS_CTRL. If 1, enumerates support for the IA32_MCU_OPT_CTRL MSR and indicates that its bit 0 (RNGDS_MITG_DIS) is also supported.                      Bit 10: MD_CLEAR supported.                      Bit 11: RTM_ALWAYS_ABORT. If set, any execution of XBEGIN immediately aborts and transitions to the specified fallback address.                      Bit 12: Reserved.                      Bit 13: If 1, RTM_FORCE_ABORT supported. Processors that set this bit support the TSX_FORCE_ABORT MSR. They allow software to set TSX_FORCE_ABORT[0] (RTM_FORCE_ABORT).                      Bit 14: SERIALIZE.                      Bit 15: Hybrid. If 1, the processor is identified as a hybrid part. If CPUID.0.MAXLEAF ≥ 1AH and CPUID.1A.EAX ≠ 0, then the Native Model ID Enumeration Leaf 1AH exists.                      Bit 16: TSXLDTRK. If 1, the processor supports Intel TSX suspend/resume of load address tracking.                      Bit 17: Reserved.                      Bit 18: PCONFIG.</p> <p>Bit 19: Architectural LBRs. If 1, indicates support for architectural LBRs.                      Bit 20: CET_IBT. Supports CET indirect branch tracking features if 1. Processors that set this bit define bits 5:2 and bits 63:10 of the IA32_U_CET and IA32_S_CET MSRs.                      Bit 21: Reserved.                      Bit 22: AMX-BF16. If 1, the processor supports tile computational operations on bfloat16 numbers.                      Bit 23: AVX512_FP16.                      Bit 24: AMX-TILE. If 1, the processor supports tile architecture.                      Bit 25: AMX-INT8. If 1, the processor supports tile computational operations on 8-bit integers.                      Bit 26: Enumerates support for indirect branch restricted speculation (IBRS) and the indirect branch predictor barrier (IBPB). Processors that set this bit support the IA32_SPEC_CTRL MSR and the IA32_PRED_CMD MSR. They allow software to set IA32_SPEC_CTRL[0] (IBRS) and IA32_PRED_CMD[0] (IBPB).                      Bit 27: Enumerates support for single thread indirect branch predictors (STIBP). Processors that set this bit support the IA32_SPEC_CTRL MSR. They allow software to set IA32_SPEC_CTRL[1] (STIBP).                      Bit 28: Enumerates support for L1D_FLUSH. Processors that set this bit support the IA32_FLUSH_CMD MSR. They allow software to set IA32_FLUSH_CMD[0] (L1D_FLUSH).                      Bit 29: Enumerates support for the IA32_ARCH_CAPABILITIES MSR.                      Bit 30: Enumerates support for the IA32_CORE_CAPABILITIES MSR.                      IA32_CORE_CAPABILITIES is an architectural MSR that enumerates model-specific features. In general, a bit being set in this MSR indicates that a model-specific feature is supported; software should consult CPUID family/model/stepping to determine the behavior of these enumerated features, as that behavior may differ on different processor models. Some bits in the MSR enumerate features with behavior that is consistent across processor models (and for which consultation of CPUID family/model/stepping is not necessary); such bits are identified explicitly in the documentation of the IA32_CORE_CAPABILITIES MSR.                      Bit 31: Enumerates support for Speculative Store Bypass Disable (SSBD). Processors that set this bit support the IA32_SPEC_CTRL MSR. They allow software to set IA32_SPEC_CTRL[2] (SSBD).</p>
Structured Extended Feature Enumeration Sub-leaf (Initial EAX Value = 07H, ECX = 1)	
07H	<p><b>NOTES:</b></p> <p>Leaf 07H output depends on the initial value in ECX.                      If ECX contains an invalid sub leaf index, EAX/EBX/ECX/EDX return 0.</p>

**Table 1-3. Information Returned by CPUID Instruction (Continued)**

Initial EAX Value	Information Provided about the Processor
EAX	<p>This field reports 0 if the sub-leaf index, 1, is invalid.</p> <p>Bit 00: SHA512. If 1, supports the SHA512 instructions.</p> <p>Bit 01: SM3. If 1, supports the SM3 instructions.</p> <p>Bit 02: SM4. If 1, supports the SM4 instructions.</p> <p>Bit 03: RAO-INT. If 1, supports the RAO-INT instructions.</p> <p>Bit 04: AVX-VNNI. AVX (VEX-encoded) versions of the Vector Neural Network Instructions.</p> <p>Bit 05: AVX512_BF16. Vector Neural Network Instructions supporting bfloat16 inputs and conversion instructions from IEEE single precision.</p> <p>Bit 06: LASS. If 1, supports Linear Address Space Separation.</p> <p>Bit 07: CMPCCXADD. If 1, supports the CMPCCXADD instruction.</p> <p>Bit 08: ArchPerfMonExt. If 1, supports ArchPerfMonExt. When set, indicates that the Architectural Performance Monitoring Extended Leaf (EAX = 23H) is valid.</p> <p>Bit 09: Reserved.</p> <p>Bit 10: If 1, supports fast zero-length MOVSB.</p> <p>Bit 11: If 1, supports fast short STOSB.</p> <p>Bit 12: If 1, supports fast short CMPSB, SCASB.</p> <p>Bits 16-13: Reserved.</p> <p>Bit 17: FRED. If 1, supports Flexible Return and Event Delivery and the architectural state (MSRs) defined by FRED. Any Intel processor that enumerates support for FRED transitions will also enumerate support for LKGS.</p> <p>Bit 18: LKGS. If 1, supports the LKGS (load into IA32_KERNEL_GS_BASE) instruction.</p> <p>Bit 19: WRMSRNS. If 1, supports the WRMSRNS instruction.</p> <p>Bit 20: NMI_SRC. If 1, supports NMI-source reporting.</p> <p>Bit 21: AMX-FP16. If 1, the processor supports tile computational operations on FP16 numbers.</p> <p>Bit 22: HRESET. If 1, supports history reset and the IA32_HRESET_ENABLE MSR. When set, indicates that the Processor History Reset Leaf (EAX = 20H) is valid.</p> <p>Bit 23: AVX-IFMA. If 1, supports the AVX-IFMA instructions.</p> <p>Bits 25-24: Reserved.</p> <p>Bit 26: LAM. If 1, supports Linear Address Masking.</p> <p>Bit 27: MSRLIST. If 1, supports the RDMSRLIST and WRMSRLIST instructions and the IA32_BARRIER MSR.</p> <p>Bits 29-28: Reserved.</p> <p>Bit 30: INVD_DISABLE_POST_BIOS_DONE. If 1, supports INVD execution prevention after BIOS Done.</p> <p>Bit 31: MOVRS.</p>
EBX	<p>This field reports 0 if the sub-leaf index, 1, is invalid; otherwise it is reserved.</p> <p>Bit 00: Enumerates the presence of the IA32_PPIN and IA32_PPIN_CTL MSRs. If 1, these MSRs are supported.</p> <p>Bit 01: PBNDKB. If 1, supports the PBNDKB instruction and enumerates the existence of the IA32_TSE_CAPABILITY MSR.</p> <p>Bits 31-02: Reserved.</p>
ECX	<p>This field reports 0 if the sub-leaf index, 1, is invalid; otherwise it is reserved.</p> <p>Bit 00: Asymmetric RDT-M. If 1, at least one logical processor on this platform supports Asymmetrical Intel® RDT Monitoring capability.<sup>1</sup></p> <p>Bit 01: Asymmetric RDT-A. If 1, at least one logical processor on this platform supports Asymmetrical Intel® RDT Allocation capability.<sup>1</sup></p> <p>Bits 04-02: Reserved.</p> <p>Bit 05: MSR_IMM. If 1, the immediate forms of the RDMSR and WRMSRNS instructions are supported.</p> <p>Bits 31-06: Reserved.</p>

**Table 1-3. Information Returned by CPUID Instruction (Continued)**

Initial EAX Value	Information Provided about the Processor
	<p>EDX This field reports 0 if the sub-leaf index, 1, is invalid.</p> <p>Bits 03-00: Reserved.</p> <p>Bit 04: AVX-VNNI-INT8. If 1, supports the AVX-VNNI-INT8 instructions.</p> <p>Bit 05: AVX-NE-CONVERT. If 1, supports the AVX-NE-CONVERT instructions.</p> <p>Bits 07-06: Reserved.</p> <p>Bit 08: AMX-COMPLEX. If 1, supports the AMX-COMPLEX instructions.</p> <p>Bit 09: Reserved.</p> <p>Bit 10: AVX-VNNI-INT16. If 1, supports the AVX-VNNI-INT16 instructions.</p> <p>Bits 12-11: Reserved.</p> <p>Bit 13: UTMR. If 1, supports user-timer events.</p> <p>Bit 14: PREFETCHI. If 1, supports the PREFETCHIT0/1 instructions.</p> <p>Bit 15: USER_MSR. If 1, supports the URDMSR and UWRMSR instructions.</p> <p>Bits 16: Reserved.</p> <p>Bit 17: UIRET_UIF. If 1, UIRET sets UIF to the value of bit 1 of the RFLAGS image loaded from the stack.</p> <p>Bit 18: CET_SSS. If 1, indicates that an operating system can enable supervisor shadow stacks as long as it ensures that a supervisor shadow stack cannot become prematurely busy due to page faults (see Section 17.2.3 of the Intel® 64 and IA-32 Architectures Software Developer’s Manual, Volume 1). When emulating the CPUID instruction, a virtual-machine monitor (VMM) should return this bit as 1 only if it ensures that VM exits cannot cause a guest supervisor shadow stack to appear to be prematurely busy. Such a VMM could set the “prematurely busy shadow stack” VM-exit control and use the additional information that it provides.</p> <p>Bit 19: AVX10. If 1, supports the Intel® AVX10 instructions and indicates the presence of CPUID Leaf 24H, which enumerates version number and supported vector lengths.</p> <p>Bit 20: Reserved.</p> <p>Bit 21: APX_F. If 1, the processor provides foundational support for Intel® Advanced Performance Extensions.</p> <p>Bit 22: Reserved.</p> <p>Bit 23: MWAIT. If 1, MWAIT is supported (even if CPUID.01H:ECX.MONITOR[bit 3] is enumerated as 0).</p> <p>Bits 31-24: Reserved.</p>
Structured Extended Feature Enumeration Sub-leaf (Initial EAX Value = 07H, ECX = 2)	
07H	<p><b>NOTES:</b></p> <p>Leaf 07H output depends on the initial value in ECX.</p> <p>If ECX contains an invalid sub leaf index, EAX/EBX/ECX/EDX return 0.</p> <p>EAX This field reports 0 if the sub-leaf index, 2, is invalid; otherwise it is reserved.</p> <p>EBX This field reports 0 if the sub-leaf index, 2, is invalid; otherwise it is reserved.</p> <p>ECX This field reports 0 if the sub-leaf index, 2, is invalid; otherwise it is reserved.</p>

**Table 1-3. Information Returned by CPUID Instruction (Continued)**

Initial EAX Value	Information Provided about the Processor	
	EDX	This field reports 0 if the sub-leaf index, 2, is invalid. Bit 00: PSFD. If 1, indicates bit 7 of the IA32_SPEC_CTRL MSR is supported. Bit 7 of this MSR disables Fast Store Forwarding Predictor without disabling Speculative Store Bypass. Bit 01: IPRED_CTRL. If 1, indicates bits 3 and 4 of the IA32_SPEC_CTRL MSR are supported. Bit 3 of this MSR enables IPRED_DIS control for CPL3. Bit 4 of this MSR enables IPRED_DIS control for CPL0/1/2. Bit 02: RRSBA_CTRL. If 1, indicates bits 5 and 6 of the IA32_SPEC_CTRL MSR are supported. Bit 5 of this MSR disables RRSBA behavior for CPL3. Bit 6 of this MSR disables RRSBA behavior for CPL0/1/2. Bit 03: DDPD_U. If 1, indicates bit 8 of the IA32_SPEC_CTRL MSR is supported. Bit 8 of this MSR disables Data Dependent Prefetcher. Bit 04: BHI_CTRL. If 1, indicates bit 10 of the IA32_SPEC_CTRL MSR is supported. Bit 10 of this MSR enables BHI_DIS_S behavior. Bit 05: MCDT_NO. Processors that enumerate this bit as 1 do not exhibit MXCSR Configuration Dependent Timing (MCDT) behavior and do not need to be mitigated to avoid data-dependent behavior for certain instructions. Bit 06: If 1, supports the UC-lock disable feature. Bit 07: MONITOR_MITG_NO. If 1, indicates that the MONITOR/UMONITOR instructions are not affected by performance or power issues due to MONITOR/UMONITOR instructions exceeding the capacity of an internal monitor tracking table. If 0, then the product may be affected by this issue. Bits 31-08: Reserved.
Structured Extended Feature Enumeration Sub-leaves (Initial EAX Value = 07H, ECX = n, n > 2)		
07H		<p><b>NOTES:</b>                      Leaf 07H output depends on the initial value in ECX.                      If ECX contains an invalid sub leaf index, EAX/EBX/ECX/EDX return 0.</p> <p>EAX This field reports 0 if the sub-leaf index, n, is invalid; otherwise it is reserved.                      EBX This field reports 0 if the sub-leaf index, n, is invalid; otherwise it is reserved.                      ECX This field reports 0 if the sub-leaf index, n, is invalid; otherwise it is reserved.                      EDX This field reports 0 if the sub-leaf index, n, is invalid; otherwise it is reserved.</p>
Direct Cache Access Information Leaf (Initial EAX Value = 09H)		
09H	EAX EBX ECX EDX	Value of bits [31:0] of IA32_PLATFORM_DCA_CAP MSR (address 1F8H). Reserved. Reserved. Reserved.
Architectural Performance Monitoring Leaf (Initial EAX Value = 0AH)		
0AH	EAX	Bits 07-00: Version ID of architectural performance monitoring. Bits 15- 08: Number of general-purpose performance monitoring counter per logical processor. Bits 23-16: Bit width of general-purpose, performance monitoring counter. Bits 31-24: Length of EBX bit vector to enumerate architectural performance monitoring events. Architectural event x is supported if EBX[x]=0 && EAX[31:24] > x.

**Table 1-3. Information Returned by CPUID Instruction (Continued)**

Initial EAX Value	Information Provided about the Processor
	<p>EBX Bit 00: Core cycle event not available if 1 or if EAX[31:24] &lt; 1.                      Bit 01: Instruction retired event not available if 1 or if EAX[31:24] &lt; 2.                      Bit 02: Reference cycles event not available if 1 or if EAX[31:24] &lt; 3.                      Bit 03: Last-level cache reference event not available if 1 or if EAX[31:24] &lt; 4.                      Bit 04: Last-level cache misses event not available if 1 or if EAX[31:24] &lt; 5.                      Bit 05: Branch instruction retired event not available if 1 or if EAX[31:24] &lt; 6.                      Bit 06: Branch mispredict retired event not available if 1 or if EAX[31:24] &lt; 7.                      Bit 07: Topdown slots event not available if 1 or if EAX[31:24] &lt; 8.                      Bit 08: Topdown backend bound not available if 1 or if EAX[31:24] &lt; 9.                      Bit 09: Topdown bad speculation not available if 1 or if EAX[31:24] &lt; 10.                      Bit 10: Topdown frontend bound not available if 1 or if EAX[31:24] &lt; 11.                      Bit 11: Topdown retiring not available if 1 or if EAX[31:24] &lt; 12.                      Bit 12: LBR inserts not available if 1 or if EAX[31:24] &lt; 13.                      Bits 31-13: Reserved = 0.</p> <p>ECX Bits 31-00: Supported fixed-function counters. If bit 'i' is set, it implies that Fixed-Function Counter 'i' is supported.                      Software is recommended to use the following logic to check if a Fixed-Function Counter is supported on a given processor: <math>FxCtr[i]_{is\_supported} := ECX[i] \parallel (EDX[4:0] &gt; i);^2</math></p> <p>EDX Bits 04-00: Number of contiguous fixed-function performance counters starting from 0 (if Version ID &gt; 1).<sup>2</sup>                      Bits 12-05: Bit width of fixed-function performance counters (if Version ID &gt; 1).                      Bits 14-13: Reserved = 0.                      Bit 15: AnyThread deprecation.                      Bits 31-16: Reserved = 0.</p>
Extended Topology Enumeration Leaf (Initial EAX Value = 0BH, ECX ≥ 0)	
<p>0BH</p>	<p><b>NOTES:</b></p> <p>CPUID leaf 1FH is a preferred superset to leaf 0BH. Intel recommends first checking for the existence of Leaf 1FH before using leaf 0BH.</p> <p>The sub-leaves of CPUID leaf 0BH describe an ordered hierarchy of logical processors starting from the smallest-scoped domain of a Logical Processor (sub-leaf index 0) to the Core domain (sub-leaf index 1) to the largest-scoped domain (the last valid sub-leaf index) that is implicitly subordinate to the unenumerated highest-scoped domain of the processor package (socket).</p> <p>The details of each valid domain is enumerated by a corresponding sub-leaf. Details for a domain include its type and how all instances of that domain determine the number of logical processors and x2 APIC ID partitioning at the next higher-scoped domain. The ordering of domains within the hierarchy is fixed architecturally as shown below. For a given processor, not all domains may be relevant or enumerated; however, the logical processor and core domains are always enumerated. For two valid sub-leaves N and N+1, sub-leaf N+1 represents the next immediate higher-scoped domain with respect to the domain of sub-leaf N for the given processor.</p> <p>If sub-leaf index "N" returns an invalid domain type in ECX[15:08] (00H), then all sub-leaves with an index greater than "N" shall also return an invalid domain type. A sub-leaf returning an invalid domain always returns 0 in EAX and EBX.</p> <p>EAX Bits 04-00: The number of bits that the x2APIC ID must be shifted to the right to address instances of the next higher-scoped domain. When logical processor is not supported by the processor, the value of this field at the Logical Processor domain sub-leaf may be returned as either 0 (no allocated bits in the x2APIC ID) or 1 (one allocated bit in the x2APIC ID); software should plan accordingly.                      Bits 31-05: Reserved.</p>

**Table 1-3. Information Returned by CPUID Instruction (Continued)**

Initial EAX Value	Information Provided about the Processor									
<p>EBX</p> <p>ECX</p> <p>EDX</p>	<p>Bits 15-00: The number of logical processors across all instances of this domain within the next higher-scoped domain. (For example, in a processor socket/package comprising “M” dies of “N” cores each, where each core has “L” logical processors, the “die” domain sub-leaf value of this field would be M*N*L.) This number reflects configuration as shipped by Intel. Note, software must not use this field to enumerate processor topology*.</p> <p>Bits 31-16: Reserved.</p> <p>Bits 07-00: The input ECX sub-leaf index.</p> <p>Bits 15-08: Domain Type. This field provides an identification value which indicates the domain as shown below. Although domains are ordered, their assigned identification values are not and software should not depend on it.</p> <table style="margin-left: 40px;"> <thead> <tr> <th style="text-align: left;"><u>Hierarchy</u></th> <th style="text-align: left;"><u>Domain</u></th> <th style="text-align: left;"><u>Domain Type Identification Value</u></th> </tr> </thead> <tbody> <tr> <td>Lowest</td> <td>Logical Processor</td> <td>1</td> </tr> <tr> <td>Highest</td> <td>Core</td> <td>2</td> </tr> </tbody> </table> <p style="margin-left: 40px;">(Note that enumeration values of 0 and 3-255 are reserved.)</p> <p>Bits 31-16: Reserved.</p> <p>Bits 31-00: x2APIC ID of the current logical processor.</p> <p><b>NOTE:</b>                      * Software must not use the value of EBX[15:0] to enumerate processor topology of the system. The value is only intended for display and diagnostic purposes. The actual number of logical processors available to BIOS/OS/Applications may be different from the value of EBX[15:0], depending on software and platform hardware configurations.</p>	<u>Hierarchy</u>	<u>Domain</u>	<u>Domain Type Identification Value</u>	Lowest	Logical Processor	1	Highest	Core	2
<u>Hierarchy</u>	<u>Domain</u>	<u>Domain Type Identification Value</u>								
Lowest	Logical Processor	1								
Highest	Core	2								
Processor Extended State Enumeration Main Leaf (Initial EAX Value = 0DH, ECX = 0)										
<p>0DH</p> <p>EAX</p> <p>EBX</p> <p>ECX</p> <p>EDX</p>	<p><b>NOTE:</b>                      Leaf 0DH main leaf (ECX = 0).</p> <p>Bits 31-00: Reports the valid bit fields of the lower 32 bits of the XFEATURE_ENABLED_MASK register. If a bit is 0, the corresponding bit field in XCRO is reserved.</p> <p>Bit 00: x87 state.                      Bit 01: SSE state.                      Bit 02: AVX state.                      Bits 04-03: MPX state                      Bit 07-05: AVX-512 state.                      Bit 08: Used for IA32_XSS.                      Bit 09: PKRU state.                      Bits 16-10: Used for IA32_XSS.                      Bit 17: TILECFG state.                      Bit 18: TILEDATA state.                      Bits 31-19: Reserved.</p> <p>Bits 31-00: Maximum size (bytes, from the beginning of the XSAVE/XRSTOR save area) required by enabled features in XCRO. May be different than ECX if some features at the end of the XSAVE save area are not enabled.</p> <p>Bit 31-00: Maximum size (bytes, from the beginning of the XSAVE/XRSTOR save area) of the XSAVE/XRSTOR save area required by all supported features in the processor, i.e all the valid bit fields in XCRO.</p> <p>Bit 31-00: Reports the valid bit fields of the upper 32 bits of the XCRO register. If a bit is 0, the corresponding bit field in XCRO is reserved</p>									

**Table 1-3. Information Returned by CPUID Instruction (Continued)**

Initial EAX Value	Information Provided about the Processor	
Processor Extended State Enumeration Sub-leaf (Initial EAX Value = 0DH, ECX = 1)		
0DH	EAX	Bit 00: XSAVEOPT is available. Bit 01: Supports XSAVEC and the compacted form of XRSTOR if set. Bit 02: Supports XGETBV with ECX = 1 if set. Bit 03: Supports XSAVES/XRSTORS and IA32_XSS if set. Bit 04: Supports Extended Feature Disable (XFD) if set. Bits 31-05: Reserved.
	EBX	Bits 31-00: The size in bytes of the XSAVE area containing all states enabled by XCRO   IA32_XSS. <b>NOTE:</b> If EAX[3] is enumerated as 0 and EAX[1] is enumerated as 1, EBX enumerates the size of the XSAVE area containing all states enabled by XCRO. If EAX[1] and EAX[3] are both enumerated as 0, EBX enumerates zero.
	ECX	Bits 31-00: Reports the supported bits of the lower 32 bits of the IA32_XSS MSR. IA32_XSS[n] can be set to 1 only if ECX[n] is 1. Bits 07-00: Used for XCRO. Bit 08: PT state. Bit 09: Used for XCRO. Bit 10: PASID state. Bit 11: CET user state. Bit 12: CET supervisor state. Bit 13: HDC state.  Bit 14: UINTR state. Bits 15: LBR state (only for the architectural LBR feature). Bit 16: HWP state. Bits 18-17: Used for XCRO. Bits 31-19: Reserved.
	EDX	Bits 31-00: Reports the supported bits of the upper 32 bits of the IA32_XSS MSR. IA32_XSS[n+32] can be set to 1 only if EDX[n] is 1. Bits 31-00: Reserved.
Processor Extended State Enumeration Sub-leaves (Initial EAX Value = 0DH, ECX = n, n > 1)		
0DH	<b>NOTES:</b> Leaf 0DH output depends on the initial value in ECX. Each sub-leaf index (starting at position 2) is supported if it corresponds to a supported bit in either the XCRO register or the IA32_XSS MSR.  * If ECX contains an invalid sub-leaf index, EAX/EBX/ECX/EDX return 0. Sub-leaf n (0 ≤ n ≤ 31) is invalid if sub-leaf 0 returns 0 in EAX[n] and sub-leaf 1 returns 0 in ECX[n]. Sub-leaf n (32 ≤ n ≤ 63) is invalid if sub-leaf 0 returns 0 in EDX[n-32] and sub-leaf 1 returns 0 in EDX[n-32].	
	EAX	Bits 31-00: The size in bytes (from the offset specified in EBX) of the save area for an extended state feature associated with a valid sub-leaf index, n. This field reports 0 if the sub-leaf index, n, is invalid.*
	EBX	Bits 31-00: The offset in bytes of this extended state component’s save area from the beginning of the XSAVE/XRSTOR area. This field reports 0 if the sub-leaf index, n, does not map to a valid bit in the XCRO register.*

**Table 1-3. Information Returned by CPUID Instruction (Continued)**

Initial EAX Value	Information Provided about the Processor	
	ECX	Bit 0 is set if the bit <i>n</i> (corresponding to the sub-leaf index) is supported in the IA32_XSS MSR; it is clear if bit <i>n</i> is instead supported in XCR0. Bit 1 is set if, when the compacted format of an XSAVE area is used, this extended state component located on the next 64-byte boundary following the preceding state component (otherwise, it is located immediately following the preceding state component). Bit 2 is set to indicate support for XFD faulting. Bits 31-03 are reserved. This field reports 0 if the sub-leaf index, <i>n</i> , is invalid.*
	EDX	This field reports 0 if the sub-leaf index, <i>n</i> , is invalid;* otherwise it is reserved.
Intel® Resource Director Technology Monitoring Enumeration Sub-leaf (Initial EAX Value = 0FH, ECX = 0)		
0FH	<p><b>NOTES:</b>                      Leaf 0FH output depends on the initial value in ECX.                      Sub-leaf index 0 reports valid resource type starting at bit position 1 of EDX.</p> <p>EAX Reserved.</p> <p>EBX Bits 31-0: Maximum range (zero-based) of RMID within this physical processor of all types.</p> <p>ECX Reserved.</p> <p>EDX Bit 00: Reserved.                      Bit 01: Supports L3 Cache Intel RDT Monitoring if 1.                      Bits 31-02: Reserved.</p>	
L3 Cache Intel® RDT Monitoring Capability Enumeration Sub-leaf (Initial EAX Value = 0FH, ECX = 1)		
0FH	<p><b>NOTE:</b>                      Leaf 0FH output depends on the initial value in ECX.</p> <p>EAX No bits set: 24-bit counters.                      Bits 07-00: Encode counter width offset from 24b:                      0x0 = 24-bit counters.                      0x1 = 25-bit counters.                      ...                      0x25 = 61-bit counters.                      Bit 08: If 1, indicates the presence of an overflow bit in the IA32_QM_CTR MSR (bit 61).                      Bit 09: If 1, indicates the presence of non-CPU agent Intel RDT CMT support.                      Bit 10: If 1, indicates the presence of non-CPU agent Intel RDT MBM support.                      Bits 31-11: Reserved.</p> <p>EBX Bits 31-00: Conversion factor from reported IA32_QM_CTR value to occupancy metric (bytes) and Memory Bandwidth Monitoring (MBM) metrics.</p> <p>ECX Maximum range (zero-based) of RMID of this resource type.</p> <p>EDX Bit 00: Supports L3 occupancy monitoring if 1.                      Bit 01: Supports L3 Total Bandwidth monitoring if 1.                      Bit 02: Supports L3 Local Bandwidth monitoring if 1.                      Bits 31-03: Reserved.</p>	
Intel® Resource Director Technology Allocation Enumeration Sub-leaf (Initial EAX Value = 10H, ECX = 0)		
10H	<p><b>NOTES:</b>                      Leaf 10H output depends on the initial value in ECX.                      Sub-leaf index 0 reports valid resource identification (ResID) starting at bit position 1 of EBX.</p> <p>EAX Reserved.</p>	





**Table 1-3. Information Returned by CPUID Instruction (Continued)**

Initial EAX Value	Information Provided about the Processor	
	ECX	Bit 00: Per-thread MBA controls are supported. Bit 01: Reserved. Bit 02: Reports whether the response of the delay values is linear. Bits 31-03: Reserved.
	EDX	Bits 15-00: Highest COS number supported for this ResID. Bits 31-16: Reserved.
Cache Bandwidth Allocation Enumeration Sub-leaf (Initial EAX Value = 10H, ECX = ResID = 5)		
10H	<p><b>NOTE:</b> Leaf 10H output depends on the initial value in ECX.</p> <p><b>EAX</b> Bits 07-00: Reports the maximum core throttling level supported for the corresponding ResID. Add one to the return value to get the number of throttling levels supported. Bits 11-08: If 1, indicates the logical processor scope of the IA32_QoS_Core_BW_Thrtl_n MSRs. Other values are reserved. Bits 31-12: Reserved.</p> <p><b>EBX</b> Bits 31-00: Reserved.</p> <p><b>ECX</b> Bits 02-00: Reserved. Bit 03: If 1, the response of the bandwidth control is approximately linear. If 0, the response of the bandwidth control is non-linear. Bits 31-04: Reserved.</p> <p><b>EDX</b> Bits 15-00: Highest Class of Service (COS) number supported for this ResID. Bits 31-16: Reserved.</p>	
Intel® Software Guard Extensions Capability Enumeration Leaf, Sub-leaf 0 (Initial EAX Value = 12H, ECX = 0)		
12H	<p><b>NOTE:</b> Leaf 12H sub-leaf 0 (ECX = 0) is supported if CPUID.(EAX=07H, ECX=0H):EBX[SGX] = 1.</p> <p><b>EAX</b> Bit 00: SGX1. If 1, indicates Intel SGX supports the collection of SGX1 leaf functions. Bit 01: SGX2. If 1, indicates Intel SGX supports the collection of SGX2 leaf functions. Bits 04-02: Reserved. Bit 05: If 1, indicates Intel SGX supports ENCLV instruction leaves EINCVIRTUALCHILD, EDECVIRTUALCHILD, and ESETCONTEXT. Bit 06: If 1, indicates Intel SGX supports ENCLS instruction leaves ETRACKC, ERDINFO, ELDBC, and ELDUC. Bit 07: If 1, indicates Intel SGX supports ENCLU instruction leaf EVERIFYREPORT2. Bits 09-08: Reserved. Bit 10: If 1, indicates Intel SGX supports ENCLS instruction leaf EUPDATESVN. Bit 11: If 1, indicates Intel SGX supports ENCLU instruction leaf EDECCSSA. Bit 12: 256BITSGX. If 1, indicates Intel SGX supports leaf functions EGETKEY256 and EREPORT2, MSR IA32_SGXLEPUBKEYHASH[4,5] and MSR IA32_SGXLECONFIG. Bits 31-13: Reserved.</p> <p><b>EBX</b> Bits 31-00: MISCSELECT. Bit vector of supported extended Intel SGX features.</p> <p><b>ECX</b> Bits 31-00: Reserved.</p> <p><b>EDX</b> Bits 07-00: MaxEnclaveSize_Not64. The maximum supported enclave size in non-64-bit mode is 2^(EDX[7:0]). Bits 15-08: MaxEnclaveSize_64. The maximum supported enclave size in 64-bit mode is 2^(EDX[15:8]). Bits 31-16: Reserved.</p>	
Intel® SGX Attributes Enumeration Leaf, Sub-leaf 1 (Initial EAX Value = 12H, ECX = 1)		

**Table 1-3. Information Returned by CPUID Instruction (Continued)**

Initial EAX Value	Information Provided about the Processor
12H	<p><b>NOTE:</b> Leaf 12H sub-leaf 1 (ECX = 1) is supported if CPUID.(EAX=07H, ECX=0H):EBX[SGX] = 1.</p> <p>EAX Bit 31-00: Reports the valid bits of SECS.ATTRIBUTES[31:0] that software can set with ECREATE.</p>
	<p>EBX Bit 31-00: Reports the valid bits of SECS.ATTRIBUTES[63:32] that software can set with ECREATE.</p> <p>ECX Bit 31-00: Reports the valid bits of SECS.ATTRIBUTES[95:64] that software can set with ECREATE.</p> <p>EDX Bit 31-00: Reports the valid bits of SECS.ATTRIBUTES[127:96] that software can set with ECREATE.</p>
Intel® SGX EPC Enumeration Leaf, Sub-leaves (Initial EAX Value = 12H, ECX = 2 or higher)	
12H	<p><b>NOTES:</b> Leaf 12H sub-leaf 2 or higher (ECX &gt;= 2) is supported if CPUID.(EAX=07H, ECX=0H):EBX[SGX] = 1. For sub-leaves (ECX = 2 or higher), definition of EDX,ECX,EBX,EAX[31:4] depends on the sub-leaf type listed below.</p> <p>EAX Bit 03-00: Sub-leaf Type. 0000b: Indicates this sub-leaf is invalid. 0001b: This sub-leaf enumerates an EPC section. EBX:EAX and EDX:ECX provide information on the Enclave Page Cache (EPC) section. All other type encodings are reserved.</p> <p>Type 0000b. This sub-leaf is invalid. EDX:ECX:EBX:EAX return 0.</p> <p>Type 0001b. This sub-leaf enumerates an EPC sections with EDX:ECX, EBX:EAX defined as follows: EAX[11:04]: Reserved (enumerate 0). EAX[31:12]: Bits 31:12 of the physical address of the base of the EPC section. EBX[19:00]: Bits 51:32 of the physical address of the base of the EPC section. EBX[31:20]: Reserved.</p> <p>ECX[03:00]: EPC section property encoding defined as follows: If ECX[3:0] = 0000b, then all bits of the EDX:ECX pair are enumerated as 0. If ECX[3:0] = 0001b, then this section has confidentiality, integrity, and replay protection. If ECX[3:0] = 0010b, then this section has confidentiality protection only. If ECX[3:0] = 0011b, then this section has confidentiality and integrity protection. All other encodings are reserved. ECX[11:04]: Reserved (enumerate 0). ECX[31:12]: Bits 31:12 of the size of the corresponding EPC section within the Processor Reserved Memory. EDX[19:00]: Bits 51:32 of the size of the corresponding EPC section within the Processor Reserved Memory. EDX[31:20]: Reserved.</p>
Intel® Processor Trace Enumeration Main Leaf (Initial EAX Value = 14H, ECX = 0)	
14H	<p><b>NOTE:</b> Leaf 14H main leaf (ECX = 0).</p> <p>EAX Bits 31-00: Reports the maximum sub-leaf supported in leaf 14H.</p>

**Table 1-3. Information Returned by CPUID Instruction (Continued)**

Initial EAX Value	Information Provided about the Processor	
	<p>EBX</p> <p>ECX</p> <p>EDX</p>	<p>Bit 00: If 1, indicates that IA32_RTIT_CTL.CR3Filter can be set to 1, and that IA32_RTIT_CR3_MATCH MSR can be accessed.</p> <p>Bits 01: If 1, indicates support of Configurable PSB and Cycle-Accurate Mode.</p> <p>Bits 02: If 1, indicates support of IP Filtering, TraceStop filtering, and preservation of Intel PT MSRs across warm reset.</p> <p>Bits 03: If 1, indicates support of MTC timing packet and suppression of COFI-based packets.</p> <p>Bit 04: If 1, indicates support of PTWRITE. Writes can set IA32_RTIT_CTL[12] (PTWEn) and IA32_RTIT_CTL[5] (FUPonPTW), and PTWRITE can generate packets.</p> <p>Bit 05: If 1, indicates support of Power Event Trace. Writes can set IA32_RTIT_CTL[4] (PwrEvtEn), enabling Power Event Trace packet generation.</p> <p>Bit 06: If 1, indicates support for PSB and PMI preservation. Writes can set IA32_RTIT_CTL[56] (InjectPsbPmiOnEnable), enabling the processor to set IA32_RTIT_STATUS[7] (PendTopaPMI) and/or IA32_RTIT_STATUS[6] (PendPSB) in order to preserve ToPA PMIs and/or PSBs otherwise lost due to Intel PT disable. Writes can also set PendToPAPMI and PendPSB.</p> <p>Bit 07: If 1, writes can set IA32_RTIT_CTL[31] (EventEn), enabling Event Trace packet generation.</p> <p>Bit 08: If 1, writes can set IA32_RTIT_CTL[55] (DisTNT), disabling TNT packet generation.</p> <p>Bit 09: If 1, Processor Trace Trigger Tracing (PTTT) is supported.</p> <p>Bits 31-10: Reserved.</p> <p>Bit 00: If 1, Tracing can be enabled with IA32_RTIT_CTL.ToPA = 1, hence utilizing the ToPA output scheme; IA32_RTIT_OUTPUT_BASE and IA32_RTIT_OUTPUT_MASK_PTRS MSRs can be accessed.</p> <p>Bit 01: If 1, ToPA tables can hold any number of output entries, up to the maximum allowed by the MaskOffsetTableOffset field of IA32_RTIT_OUTPUT_MASK_PTRS.</p> <p>Bit 02: If 1, indicates support of Single-Range Output scheme.</p> <p>Bit 03: If 1, indicates support of output to Trace Transport subsystem.</p> <p>Bits 30-04: Reserved.</p> <p>Bit 31: If 1, generated packets which contain IP payloads have LIP values, which include the CS base component.</p> <p>Bits 31-00: Reserved.</p>
Intel® Processor Trace Enumeration Sub-leaf (Initial EAX Value = 14H, ECX = 1)		
14H	<p>EAX</p> <p>EBX</p> <p>ECX</p> <p>EDX</p>	<p>Bits 02-00: Number of configurable Address Ranges for filtering.</p> <p>Bits 07-03: Reserved.</p> <p>Bits 10-8: Number of IA32_RTIT_TRIGGERx_CFG MSRs. The number of triggers supported is 4x this value.</p> <p>Bits 15-11: Reserved.</p> <p>Bits 31-16: Bitmap of supported MTC period encodings.</p> <p>Bits 15-00: Bitmap of supported Cycle Threshold value encodings.</p> <p>Bits 31-16: Bitmap of supported Configurable PSB frequency encodings.</p> <p>Bit 00: If 1, Trigger Action Attribution is supported.</p> <p>Bit 01: If 1, the trigger actions TRACE_PAUSE and TRACE_RESUME are supported.</p> <p>Bits 14-02: Reserved.</p> <p>Bit 15: If 1, trigger input DR match is supported.</p> <p>Bits 31-16: Reserved.</p> <p>Bits 31-00: Reserved.</p>

**Table 1-3. Information Returned by CPUID Instruction (Continued)**

Initial EAX Value	Information Provided about the Processor	
Time Stamp Counter and Core Crystal Clock Information Leaf (Initial EAX Value = 15H)		
15H		<p><b>NOTES:</b>                      If EBX[31:0] is 0, the TSC and “core crystal clock” ratio is not enumerated. EBX[31:0]/EAX[31:0] indicates the ratio of the TSC frequency and the core crystal clock frequency.                      If ECX is 0, the core crystal clock frequency is not enumerated.                      “TSC frequency” = “core crystal clock frequency” * EBX/EAX.                      The core crystal clock may differ from the reference clock, bus clock, or core clock frequencies.</p> <p>EAX     Bits 31-00: An unsigned integer which is the denominator of the TSC/“core crystal clock” ratio.                      EBX     Bits 31-00: An unsigned integer which is the numerator of the TSC/“core crystal clock” ratio.                      ECX     Bits 31-00: An unsigned integer which is the nominal frequency of the core crystal clock in Hz.                      EDX     Bits 31-00: Reserved = 0.</p>
Processor Frequency Information Leaf (Initial EAX Value = 16H)		
16H	<p>EAX EBX ECX EDX</p>	<p>Bits 15-00: Processor Base Frequency (in MHz).                      Bits 31-16: Reserved = 0.</p> <p>Bits 15-00: Maximum Frequency (in MHz).                      Bits 31-16: Reserved = 0.</p> <p>Bits 15-00: Bus (Reference) Frequency (in MHz).                      Bits 31-16: Reserved = 0.</p> <p>Reserved.</p> <p><b>NOTES:</b>                      Data is returned from this interface in accordance with the processor’s specification and does not reflect actual values. Suitable use of this data includes the display of processor information in like manner to the processor brand string and for determining the appropriate range to use when displaying processor information e.g. frequency history graphs. The returned information should not be used for any other purpose as the returned information does not accurately correlate to information / counters returned by other processor interfaces.</p> <p>While a processor may support the Processor Frequency Information leaf, fields that return a value of zero are not supported.</p>
System-On-Chip Vendor Attribute Enumeration Main Leaf (Initial EAX Value = 17H, ECX = 0)		
17H		<p><b>NOTES:</b>                      Leaf 17H main leaf (ECX = 0).                      Leaf 17H output depends on the initial value in ECX.                      Leaf 17H sub-leaves 1 through 3 reports SOC Vendor Brand String.                      Leaf 17H is valid if MaxSOCID_Index &gt;= 3.                      Leaf 17H sub-leaves 4 and above are reserved.</p> <p>EAX     Bits 31-00: MaxSOCID_Index. Reports the maximum input value of supported sub-leaf in leaf 17H.                      EBX     Bits 15-00: SOC Vendor ID.                      Bit 16: IsVendorScheme. If 1, the SOC Vendor ID field is assigned via an industry standard enumeration scheme. Otherwise, the SOC Vendor ID field is assigned by Intel.                      Bits 31-17: Reserved = 0.                      ECX     Bits 31-00: Project ID. A unique number an SOC vendor assigns to its SOC projects.                      EDX     Bits 31-00: Stepping ID. A unique number within an SOC project that an SOC vendor assigns.</p>

**Table 1-3. Information Returned by CPUID Instruction (Continued)**

Initial EAX Value	Information Provided about the Processor	
System-On-Chip Vendor Attribute Enumeration Sub-leaf (Initial EAX Value = 17H, ECX = 1..3)		
17H	EAX	Bit 31-00: SOC Vendor Brand String. UTF-8 encoded string.
	EBX	Bit 31-00: SOC Vendor Brand String. UTF-8 encoded string.
	ECX	Bit 31-00: SOC Vendor Brand String. UTF-8 encoded string.
	EDX	Bit 31-00: SOC Vendor Brand String. UTF-8 encoded string.
	<p><b>NOTES:</b>                      Leaf 17H output depends on the initial value in ECX.                      SOC Vendor Brand String is a UTF-8 encoded string padded with trailing bytes of 00H.                      The complete SOC Vendor Brand String is constructed by concatenating in ascending order of EAX:EBX:ECX:EDX and from the sub-leaf 1 fragment towards sub-leaf 3.</p>	
System-On-Chip Vendor Attribute Enumeration Sub-leaves (Initial EAX Value = 17H, ECX > MaxSOCID_Index)		
17H	<p><b>NOTE:</b>                      Leaf 17H output depends on the initial value in ECX.</p>	
	EAX	Bits 31-00: Reserved = 0.
	EBX	Bits 31-00: Reserved = 0.
	ECX	Bits 31-00: Reserved = 0.
	EDX	Bits 31-00: Reserved = 0.
Deterministic Address Translation Parameters Main Leaf (Initial EAX Value = 18H, ECX = 0)		
18H	<p><b>NOTES:</b>                      Each sub-leaf enumerates a different address translations structure.                      If ECX contains an invalid sub-leaf index, EAX/EBX/ECX/EDX return 0. Sub-leaf index n is invalid if n exceeds the value that sub-leaf 0 returns in EAX. A sub-leaf index is also invalid if EDX[4:0] returns 0. Valid sub-leaves do not need to be contiguous or in any particular order. A valid sub-leaf may be in a higher input ECX value than an invalid sub-leaf or than a valid sub-leaf of a higher or lower-level structure.                      * Some unified TLBs will allow a single TLB entry to satisfy data read/write and instruction fetches. Others will require separate entries (e.g., one loaded on data read/write and another loaded on an instruction fetch). See the Intel® 64 and IA-32 Architectures Optimization Reference Manual for details of a particular product.                      ** Add one to the return value to get the result.</p>	
	EAX	Bits 31-00: Reports the maximum input value of supported sub-leaf in leaf 18H.
	EBX	Bit 00: 4K page size entries supported by this structure. Bit 01: 2MB page size entries supported by this structure. Bit 02: 4MB page size entries supported by this structure. Bit 03: 1 GB page size entries supported by this structure. Bits 07-04: Reserved. Bits 10-08: Partitioning (0: Soft partitioning between the logical processors sharing this structure). Bits 15-11: Reserved. Bits 31-16: W = Ways of associativity.
	ECX	Bits 31-00: S = Number of Sets.

**Table 1-3. Information Returned by CPUID Instruction (Continued)**

Initial EAX Value	Information Provided about the Processor
	<p>EDX Bits 04-00: Translation cache type field.                      00000b: Null (indicates this sub-leaf is not valid).                      00001b: Data TLB.                      00010b: Instruction TLB.                      00011b: Unified TLB.                      00100b: Load Only TLB. Hit on loads; fills on both loads and stores.                      00101b: Store Only TLB. Hit on stores; fill on stores.                      All other encodings are reserved.                      Bits 07-05: Translation cache level (starts at 1).                      Bit 08: Fully associative structure.                      Bits 13-09: Reserved.                      Bits 25-14: Maximum number of addressable IDs for logical processors sharing this translation cache.**                      Bits 31-26: Reserved.</p>
<p>Deterministic Address Translation Parameters Sub-leaf (Initial EAX Value = 18H, ECX ≥ 1)</p>	
<p>18H</p>	<p><b>NOTES:</b>                      If ECX contains an invalid sub-leaf index, EAX/EBX/ECX/EDX return 0. Sub-leaf index n is invalid if n exceeds the value that sub-leaf 0 returns in EAX. A sub-leaf index is also invalid if EDX[4:0] returns 0. Valid sub-leaves do not need to be contiguous or in any particular order. A valid sub-leaf may be in a higher input ECX value than an invalid sub-leaf or than a valid sub-leaf of a higher or lower-level structure.                      * Some unified TLBs will allow a single TLB entry to satisfy data read/write and instruction fetches. Others will require separate entries (e.g., one loaded on data read/write and another loaded on an instruction fetch). See the Intel® 64 and IA-32 Architectures Optimization Reference Manual for details of a particular product.                      ** Add one to the return value to get the result.</p> <p>EAX Bits 31-00: Reserved.</p> <p>EBX Bit 00: 4K page size entries supported by this structure.                      Bit 01: 2MB page size entries supported by this structure.                      Bit 02: 4MB page size entries supported by this structure.                      Bit 03: 1 GB page size entries supported by this structure.                      Bits 07-04: Reserved.                      Bits 10-08: Partitioning (0: Soft partitioning between the logical processors sharing this structure).                      Bits 15-11: Reserved.                      Bits 31-16: W = Ways of associativity.</p> <p>ECX Bits 31-00: S = Number of Sets.</p> <p>EDX Bits 04-00: Translation cache type field.                      0000b: Null (indicates this sub-leaf is not valid).                      0001b: Data TLB.                      0010b: Instruction TLB.                      0011b: Unified TLB.                      All other encodings are reserved.                      Bits 07-05: Translation cache level (starts at 1).                      Bit 08: Fully associative structure.                      Bits 13-09: Reserved.                      Bits 25-14: Maximum number of addressable IDs for logical processors sharing this translation cache.**                      Bits 31-26: Reserved.</p>

**Table 1-3. Information Returned by CPUID Instruction (Continued)**

Initial EAX Value	Information Provided about the Processor	
Key Locker Leaf (Initial EAX Value = 19H)		
19H	EAX	Bit 00: Key Locker restriction of CPL0-only supported. Bit 01: Key Locker restriction of no-encrypt supported. Bit 02: Key Locker restriction of no-decrypt supported. Bits 31-03: Reserved.
	EBX	Bit 00: AESKLE. If 1, the AES Key Locker instructions are fully enabled. Bit 01: Reserved. Bit 02: If 1, the AES wide Key Locker instructions are supported. Bit 03: Reserved. Bit 04: If 1, the platform supports the Key Locker MSRs and backing up the internal wrapping key. Bits 31-05: Reserved.
	ECX	Bit 00: If 1, the NoBackup parameter to LOADIWKEY is supported. Bit 01: If 1, KeySource encoding of 1 (randomization of the internal wrapping key) is supported. Bits 31- 02: Reserved.
	EDX	Reserved.
Native Model ID Enumeration Leaf (Initial EAX Value = 1AH, ECX = 0)		
1AH	EAX	<p><b>NOTE:</b>                      This leaf exists on all hybrid parts, however this leaf is not only available on hybrid parts. The following algorithm is used for detection of this leaf:                      If CPUID.0.MAXLEAF ≥ 1AH and CPUID.1A.EAX ≠ 0, then the leaf exists.</p> <p>Enumerates the native model ID and core type.*                      Bits 31-24: Core type                      10H: Reserved.                      20H: Intel Atom®.                      30H: Reserved.                      40H: Intel® Core™.</p> <p>Bits 23-0: Native model ID of the core. The core-type and native model ID can be used to uniquely identify the microarchitecture of the core. This native model ID is not unique across core types, and not related to the model ID reported in CPUID leaf 01H, and does not identify the SOC.</p> <p><b>NOTE:</b>                      * The core type may only be used as an identification of the microarchitecture for this logical processor and its numeric value has no significance, neither large nor small. This field neither implies nor expresses any other attribute to this logical processor and software should not assume any.</p>
	EBX	Reserved.
	ECX	Reserved.
	EDX	Reserved.
PCONFIG Information Sub-leaf (Initial EAX Value = 1BH, ECX ≥ 0)		
1BH	For details on this sub-leaf, see "INPUT EAX = 1BH: Returns PCONFIG Information" on page 1-48. <p><b>NOTE:</b>                      Leaf 1BH is supported if CPUID.(EAX=07H, ECX=0H):EDX[18] = 1.</p>	
Last Branch Records Information Leaf (Initial EAX Value = 1CH)		
1CH	<p><b>NOTES:</b>                      This leaf pertains to the architectural feature.                      For leaf 01CH, CPUID will ignore the ECX value.</p>	



**Table 1-3. Information Returned by CPUID Instruction (Continued)**

Initial EAX Value	Information Provided about the Processor	
	EAX	Bits 07 - 00: Supported LBR Depth Values. For each bit n set in this field, the IA32_LBR_DEPTH.DEPTH value 8*(n+1) is supported. Bits 29 - 08: Reserved. Bit 30: Deep C-state Reset. If set, indicates that LBRs may be cleared on an MWAIT that requests a C-state numerically greater than C1. Bit 31: IP Values Contain LIP. If set, LBR IP values contain LIP. If clear, IP values contain Effective IP.
	EBX	Bit 00: CPL Filtering Supported. If set, the processor supports setting IA32_LBR_CTL[2:1] to a non-zero value. Bit 01: Branch Filtering Supported. If set, the processor supports setting IA32_LBR_CTL[22:16] to a non-zero value. Bit 02: Call-stack Mode Supported. If set, the processor supports setting IA32_LBR_CTL[3] to 1. Bits 31-03: Reserved.
	ECX	Bit 00: Mispredict Bit Supported. IA32_LBR_x_INFO[63] holds indication of branch misprediction (MISPRED). Bit 01: Timed LBRs Supported. IA32_LBR_x_INFO[15:0] holds CPU cycles since last LBR entry (CYC_CNT), and IA32_LBR_x_INFO[60] holds an indication of whether the value held there is valid (CYC_CNT_VALID). Bit 02: Branch Type Field Supported. IA32_LBR_INFO_x[59:56] holds indication of the recorded operation's branch type (BR_TYPE). Bits 15-03: Reserved. Bits 19-16: Event Logging Supported bitmap. Bits 31-20: Reserved.
	EDX	Bits 31 - 00: Reserved.
Tile Information Main Leaf (Initial EAX Value = 1DH, ECX = 0)		
1DH	<p><b>NOTES:</b>                      For sub-leaves of 1DH, they are indexed by the palette id.                      Leaf 1DH sub-leaves 2 and above are reserved.</p> <p>EAX Bits 31-00: max_palette. Highest numbered palette sub-leaf. Value = 1.                      EBX Bits 31-00: Reserved = 0.                      ECX Bits 31-00: Reserved = 0.                      EDX Bits 31-00: Reserved = 0.</p>	
Tile Palette 1 Sub-leaf (Initial EAX Value = 1DH, ECX = 1)		
1DH	EAX	Bits 15-00: Palette 1 total_tile_bytes. Value = 8192. Bits 31-16: Palette 1 bytes_per_tile. Value = 1024.
	EBX	Bits 15-00: Palette 1 bytes_per_row. Value = 64. Bits 31-16: Palette 1 max_names (number of tile registers). Value = 8.
	ECX	Bits 15-00: Palette 1 max_rows. Value = 16. Bits 31-16: Reserved = 0.
	EDX	Bits 31-00: Reserved = 0.
TMUL Information Main Leaf (Initial EAX Value = 1EH, ECX = 0)		
1EH	<p><b>NOTE:</b>                      Leaf 1EH sub-leaf 2 and above are reserved.</p> <p>EAX Bits 31-00: Reports the maximum number of sub-leaves that are supported in leaf 1EH.                      EBX Bits 07-00: tmul_maxk (rows or columns). Value = 16.                      Bits 23-08: tmul_maxn (column bytes). Value = 64.                      Bits 31-24: Reserved = 0.</p>	

**Table 1-3. Information Returned by CPUID Instruction (Continued)**

Initial EAX Value	Information Provided about the Processor	
	ECX	Bits 31-00: Reserved = 0.
	EDX	Bits 31-00: Reserved = 0.
TMUL Information Sub-leaf (Initial EAX Value = 1EH, ECX = 1)		
1EH	<p><b>NOTE:</b> Leaf 1EH sub-leaf 2 and above are reserved.</p> <p><b>EAX</b> Bit 00: AMX-INT8. If 1, the processor supports tile computational operations on 8-bit integers. Bit 01: AMX-BF16. If 1, the processor supports tile computational operations on bfloat16 numbers. Bit 02: AMX-COMPLEX. If 1, supports the AMX-COMPLEX instructions. Bit 03: AMX-FP16. If 1, the processor supports tile computational operations on FP16 numbers. Bit 04: AMX-FP8. If 1, supports Intel AMX computations for the FP8 data type. Bit 05: AMX-TRANPOSE. If 1, supports the AMX-TRANPOSE. instructions. Bit 06: AMX-TF32 (FP19). If 1, supports the AMX-TF32 (FP19) instructions. Bit 07: AMX-AVX512. If 1, supports the AMX-AVX512 instructions. Bit 08: AMX-MOVRs. If 1, supports the AMX-MOVRs instructions. Bits 31-09: Reserved = 0.</p> <p><b>EBX</b> Bits 31-00: Reserved = 0.</p> <p><b>ECX</b> Bits 31-00: Reserved = 0.</p> <p><b>EDX</b> Bits 31-00: Reserved = 0.</p>	
V2 Extended Topology Enumeration Leaf (Initial EAX Value = 1FH, ECX ≥ 0)		
1FH	<p><b>NOTES:</b> CPUID leaf 1FH is a preferred superset to leaf 0BH. Intel recommends using leaf 1FH when available rather than leaf 0BH and ensuring that any leaf 0BH algorithms are updated to support leaf 1FH. The sub-leaves of CPUID leaf 1FH describe an ordered hierarchy of logical processors starting from the smallest-scoped domain of a Logical Processor (sub-leaf index 0) to the Core domain (sub-leaf index 1) to the largest-scoped domain (the last valid sub-leaf index) that is implicitly subordinate to the unenumerated highest-scoped domain of the processor package (socket). The details of each valid domain is enumerated by a corresponding sub-leaf. Details for a domain include its type and how all instances of that domain determine the number of logical processors and x2 APIC ID partitioning at the next higher-scoped domain. The ordering of domains within the hierarchy is fixed architecturally as shown below. For a given processor, not all domains may be relevant or enumerated; however, the logical processor and core domains are always enumerated. As an example, a processor may report an ordered hierarchy consisting only of "Logical Processor," "Core," and "Die." For two valid sub-leaves N and N+1, sub-leaf N+1 represents the next immediate higher-scoped domain with respect to the domain of sub-leaf N for the given processor. If sub-leaf index "N" returns an invalid domain type in ECX[15:08] (00H), then all sub-leaves with an index greater than "N" shall also return an invalid domain type. A sub-leaf returning an invalid domain always returns 0 in EAX and EBX.</p> <p><b>EAX</b> Bits 04-00: The number of bits that the x2APIC ID must be shifted to the right to address instances of the next higher-scoped domain. When logical processor is not supported by the processor, the value of this field at the Logical Processor domain sub-leaf may be returned as either 0 (no allocated bits in the x2APIC ID) or 1 (one allocated bit in the x2APIC ID); software should plan accordingly. Bits 31-05: Reserved.</p>	

**Table 1-3. Information Returned by CPUID Instruction (Continued)**

Initial EAX Value	Information Provided about the Processor																									
	EBX	<p>Bits 15-00: The number of logical processors across all instances of this domain within the next higher-scoped domain relative to this current logical processor. (For example, in a processor socket/package symmetric topology comprising “M” dies of “N” cores each, where each core has “L” logical processors, the “die” domain sub-leaf value of this field would be M*N*L. In an asymmetric topology this would be the summation of the value across the lower domain level instances to create each upper domain level instance.) This number reflects configuration as shipped by Intel. Note, software must not use this field to enumerate processor topology*.</p> <p>Bits 31-16: Reserved.</p>																								
	ECX	<p>Bits 07-00: The input ECX sub-leaf index.</p> <p>Bits 15-08: Domain Type. This field provides an identification value which indicates the domain as shown below. Although domains are ordered, as also shown below, their assigned identification values are not and software should not depend on it. (For example, if a new domain between core and module is specified, it will have an identification value higher than 5.)</p> <table style="margin-left: 40px;"> <thead> <tr> <th style="text-align: left;"><u>Hierarchy</u></th> <th style="text-align: left;"><u>Domain</u></th> <th style="text-align: left;"><u>Domain Type Identification Value</u></th> </tr> </thead> <tbody> <tr> <td>Lowest</td> <td>Logical Processor</td> <td>1</td> </tr> <tr> <td>...</td> <td>Core</td> <td>2</td> </tr> <tr> <td>...</td> <td>Module</td> <td>3</td> </tr> <tr> <td>...</td> <td>Tile</td> <td>4</td> </tr> <tr> <td>...</td> <td>Die</td> <td>5</td> </tr> <tr> <td>...</td> <td>DieGrp</td> <td>6</td> </tr> <tr> <td>Highest</td> <td>Package/Socket</td> <td>(implied)</td> </tr> </tbody> </table> <p>(Note that enumeration values of 0 and 7-255 are reserved.)</p> <p>Bits 31-16: Reserved.</p>	<u>Hierarchy</u>	<u>Domain</u>	<u>Domain Type Identification Value</u>	Lowest	Logical Processor	1	...	Core	2	...	Module	3	...	Tile	4	...	Die	5	...	DieGrp	6	Highest	Package/Socket	(implied)
<u>Hierarchy</u>	<u>Domain</u>	<u>Domain Type Identification Value</u>																								
Lowest	Logical Processor	1																								
...	Core	2																								
...	Module	3																								
...	Tile	4																								
...	Die	5																								
...	DieGrp	6																								
Highest	Package/Socket	(implied)																								
	EDX	<p>Bits 31-00: x2APIC ID of the current logical processor. It is always valid and does not vary with the sub-leaf index in ECX.</p> <p><b>NOTES:</b></p> <p>* Software must not use the value of EBX[15:0] to enumerate processor topology of the system. The value is only intended for display and diagnostic purposes. The actual number of logical processors available to BIOS/OS/Applications may be different from the value of EBX[15:0], depending on software and platform hardware configurations.</p>																								
Processor History Reset Sub-leaf (Initial EAX Value = 20H, ECX = 0)																										
20H	EAX	Reports the maximum number of sub-leaves that are supported in leaf 20H.																								
	EBX	<p>Indicates which bits may be set in the IA32_HRESET_ENABLE MSR to enable enhanced hardware feedback interface history.</p> <p>Bit 00: Indicates support for both HRESET’s EAX[0] parameter, and IA32_HRESET_ENABLE[0] set by the OS to enable reset of EHFI history.</p> <p>Bits 31-01: Reserved for other history reset capabilities.</p>																								
	ECX	Reserved.																								
	EDX	Reserved.																								
Architectural Performance Monitoring Extended Main Leaf (Initial EAX Value = 23H, ECX = 0)																										
23H	<p><b>NOTE:</b></p> <p>Output depends on ECX input value.</p>																									

**Table 1-3. Information Returned by CPUID Instruction (Continued)**

Initial EAX Value	Information Provided about the Processor	
	EAX	Bit 00: If 1, CPUID Leaf 23H, Subleaf 00H exists. Bit 01: If 1, CPUID Leaf 23H, Subleaf 01H exists. Bit 02: If 1, CPUID Leaf 23H, Subleaf 02H exists. Bit 03: If 1, CPUID Leaf 23H, Subleaf 03H exists. Bit 04: If 1, CPUID Leaf 23H, Subleaf 04H exists. Bit 05: If 1, CPUID Leaf 23H, Subleaf 05H exists. The processor supports Architectural PEBS. The IA32_PEBS_BASE and IA32_PEBS_INDEX MSRs exist. Bits 31-06: Reserved.
	EBX	Bit 00: UnitMask2 Supported. If set, the processor supports the UnitMask2 field in the IA32_PERFEVTSELx MSRs. Bit 01: EQ-bit Supported. If set, the processor supports the equal flag in the IA32_PERFEVTSELx MSRs. Bits 31-02: Reserved.
	ECX	Bits 07-00: Number of slots per cycle. This number can be multiplied by the number of cycles (from CPU_CLK_UNHALTED.THREAD / CPU_CLK_UNHALTED.CORE or IA32_FIXED_CTR1) to determine the total number of slots. Bits 31-08: Reserved.
	EDX	Bits 31-00: Reserved.
Architectural Performance Monitoring Extended Sub-Leaf (Initial EAX Value = 23H, ECX = 1)		
23H	EAX	Bits 31-00: General-purpose counters bitmap. For each bit <i>n</i> set in this field, the processor supports general-purpose performance monitoring counter <i>n</i> .
	EBX	Bits 31-00: Fixed-function counters bitmap. For each bit <i>m</i> set in this field, the processor supports fixed-function performance monitoring counter <i>m</i> . <sup>2</sup>
	ECX	Bits 31-00: Reserved.
	EDX	Bits 31-00: Reserved.
Architectural Performance Monitoring Extended Sub-Leaf (Initial EAX Value = 23H, ECX = 2)		
23H	EAX	Bits 31-00: Bitmap of Auto Counter Reload (ACR) general-purpose counters that can be reloaded. For each bit <i>n</i> set in this field, the processor supports ACR for general-purpose performance monitoring counter <i>n</i> .
	EBX	Bits 31-00: Bitmap of Auto Counter Reload (ACR) fixed-function counters that can be reloaded. For each bit <i>m</i> set in this field, the processor supports ACR for fixed-function performance monitoring counter <i>m</i> .
	ECX	Bits 31-00: Bitmap of Auto Counter Reload (ACR) general-purpose counters that can cause reloads. For each bit <i>y</i> set in this field, the processor allows general-purpose performance monitoring counter <i>y</i> to reload all existing general-purpose performance monitoring counters capable of being reloaded.
	EDX	Bits 31-00: Bitmap of Auto Counter Reload (ACR) fixed-function counters that can cause reloads. For each bit <i>x</i> set in this field, the processor allows fixed-function performance monitoring counter <i>x</i> to reload all existing fixed-function performance monitoring counters capable of being reloaded.
Architectural Performance Monitoring Extended Sub-Leaf (Initial EAX Value = 23H, ECX = 3)		
23H	<b>NOTE:</b> Architectural Performance Monitoring Events Bitmap. For each bit <i>n</i> set in this field, the processor supports Architectural Performance Monitoring Event of index <i>n</i> .	

**Table 1-3. Information Returned by CPUID Instruction (Continued)**

Initial EAX Value	Information Provided about the Processor	
	EAX	Bit 00: Core cycles. Bit 01: Instructions retired. Bit 02: Reference cycles. Bit 03: Last level cache references. Bit 04: Last level cache misses. Bit 05: Branch instructions retired. Bit 06: Branch mispredicts retired. Bit 07: Topdown slots. Bit 08: Topdown backend bound. Bit 09: Topdown bad speculation.  Bit 10: Topdown frontend bound. Bit 11: Topdown retiring. Bit 12: LBR inserts. Bits 31-13: Reserved.
	EBX	Bits 31-00: Reserved.
	ECX	Bits 31-00: Reserved.
	EDX	Bits 31-00: Reserved.
Architectural Performance Monitoring Extended Sub-Leaf (Initial EAX Value = 23H, ECX = 4)		
23H	EAX	Bits 31-00: Reserved.
	EBX	Bits 02-00: Reserved. Bit 03: ALLOW_IN_RECORD. If 1, indicates that the ALLOW_IN_RECORD bit is available in the IA32_PMC_GPn_CFG_C and IA32_PMC_FXm_CFG_C MSRs. Bits 07-04: CNTR. Counters group sub-groups general-purpose counters, fixed-function counters, and performance metrics are available. Bits 09-08: LBR. LBR group and both bits [41:40] are available. Bits 15-10: Reserved. Bits 23-16: XER. XER group bits [50:49] and bits [55:53] are available. See Section 11.4.4, "XSAVE-Enabled Registers Group," for XER fields. Bits 28-24: Reserved. Bit 29: GPR. If 1, the GPR group is available. Bit 30: AUX. If 1, the AUX group is available. Bit 31: Reserved.
	ECX	Bits 31-00: Reserved.
	EDX	Bits 31-00: Reserved.
Architectural Performance Monitoring Extended Sub-Leaf (Initial EAX Value = 23H, ECX = 5)		
23H	EAX	Bits 31-00: General-purpose counters support Architectural PEBS. Bit vector of general-purpose counters for which the Architectural PEBS mechanism is available (bit n == GP counter #n). If EAX[n] == 1, then the IA32_PMC_GPn_CFG_C MSR is available, and PEBS is supported on that counter; the PEBS_EN[63] field can be set; and the RELOAD[31:0] field can be set. Note that CPUID.(EAX=23H, ECX=04H);EBX governs which adaptive group bits can be set.
	EBX	Bits 31-00: General-purpose counters for which PEBS supports PDIST.
	ECX	Bits 31-00: Fixed-function counters support Architectural PEBS. Bit vector of fixed-function counters for which the Architectural PEBS mechanism is available. If ECX[x] == 1, then the IA32_PMC_FXm_CFG_C MSR is available, and PEBS is supported; the PEBS_EN[63] field can be set; and the RELOAD[31:0] field can be set. Note that CPUID.(EAX=23H, ECX=04H);EBX governs which adaptive group bits can be set.
	EDX	Bits 31-00: Fixed-function counters for which PEBS supports PDIST.

**Table 1-3. Information Returned by CPUID Instruction (Continued)**

Initial EAX Value	Information Provided about the Processor	
Converged Vector ISA Main Leaf (Initial EAX Value = 24H, ECX = 0)		
24H		<p><b>NOTE:</b> Output depends on ECX input value.</p> <p>EAX Bits 31-00: Reports the maximum number sub-leaves that are supported in leaf 24H.</p> <p>EBX Bits 07-00: Reports the Intel AVX10 Converged Vector ISA version. Bits 15-08: Reserved. Bit 18-16: Reserved at 111.<sup>3</sup> Bits 31-19: Reserved.</p> <p>ECX Bits 31-00: Reserved.</p> <p>EDX Bits 31-00: Reserved.</p>
Intel® Resource Director Technology Monitoring Asymmetric Enumeration Sub-leaf (Initial EAX Value = 27H, ECX = 0)		
27H		<p><b>NOTES:</b> Leaf 27H output depends on the initial value in ECX. Sub-leaf index 0 reports valid resource type starting at bit position 1 of EDX. Leaf 27H can return different information on each logical processor and software must account for this.</p>
	EAX	Reserved.
	EBX	Bits 31-0: Maximum range (zero-based) of RMID within this physical processor of all types.
	ECX	Reserved.
	EDX	Bit 00: Reserved. Bit 01: Supports L3 Cache Intel RDT Monitoring if 1. Bits 31-02: Reserved.
L3 Cache Intel® RDT Monitoring Capability Asymmetric Enumeration Sub-leaf (Initial EAX Value = 27H, ECX = 1)		
27H		<p><b>NOTE:</b> Leaf 27H output depends on the initial value in ECX. Leaf 27H can return different information on each logical processor and software must account for this.</p>
	EAX	No bits set: 24-bit counters. Bits 07-00: Encode counter width offset from 24b: 0x0 = 24-bit counters. 0x1 = 25-bit counters. ... 0x25 = 61-bit counters. Bit 08: If 1, indicates the presence of an overflow bit in the IA32_QM_CTR MSR (bit 61). Bit 09: If 1, indicates the presence of non-CPU agent Intel RDT CMT support. Bit 10: If 1, indicates the presence of non-CPU agent Intel RDT MBM support. Bits 31-11: Reserved.
	EBX	Bits 31-00: Conversion factor from reported IA32_QM_CTR value to occupancy metric (bytes) and Memory Bandwidth Monitoring (MBM) metrics.
	ECX	Maximum range (zero-based) of RMID of this resource type.
	EDX	Bit 00: Supports L3 occupancy monitoring if 1. Bit 01: Supports L3 Total Bandwidth monitoring if 1. Bit 02: Supports L3 Local Bandwidth monitoring if 1. Bits 31-03: Reserved.
Intel® Resource Director Technology Allocation Asymmetric Enumeration Sub-leaf (Initial EAX Value = 28H, ECX = 0)		

**Table 1-3. Information Returned by CPUID Instruction (Continued)**

Initial EAX Value	Information Provided about the Processor	
28H		<p><b>NOTES:</b>                      Leaf 28H output depends on the initial value in ECX.                      Sub-leaf index 0 reports valid resource identification (ResID) starting at bit position 1 of EBX.                      Leaf 28H can return different information on each logical processor and software must account for this.</p>
	EAX	Reserved.
	EBX	Bit 00: Reserved. Bit 01: Supports L3 Cache Allocation Technology if 1. Bit 02: Supports L2 Cache Allocation Technology if 1. Bit 03: Supports Memory Bandwidth Allocation if 1. Bit 04: Reserved. Bit 05: Supports Cache Bandwidth Allocation if 1. Bits 31-06: Reserved.
	ECX	Reserved.
	EDX	Reserved.
L3 Cache Intel® RDT Allocation Asymmetric Enumeration Sub-leaf (Initial EAX Value = 28H, ECX = ResID = 1)		
28H		<p><b>NOTE:</b>                      Leaf 28H output depends on the initial value in ECX.                      Leaf 28H can return different information on each logical processor and software must account for this.</p>
	EAX	Bits 04-00: Length of the capacity bit mask for the corresponding ResID. Add one to the return value to get the result. Bits 31-05: Reserved.
	EBX	Bits 31-00: Bit-granular map of isolation/contention of allocation units.
	ECX	Bit 00: Reserved. Bit 01: If 1, indicates L3 CAT for non-CPU agents is supported. Bit 02: If 1, indicates L3 Code and Data Prioritization Technology is supported. Bit 03: If 1, indicates non-contiguous capacity bitmask is supported. The bits that are set in the various IA32_L3_MASK_n registers do not have to be contiguous. Bits 31-04: Reserved.
	EDX	Bits 15-00: Highest COS number supported for this ResID. Bits 31-16: Reserved.
L2 Cache Intel® RDT Allocation Asymmetric Enumeration Sub-leaf (Initial EAX Value = 28H, ECX = ResID = 2)		
28H		<p><b>NOTE:</b>                      Leaf 28H output depends on the initial value in ECX.                      Leaf 28H can return different information on each logical processor and software must account for this.</p>
	EAX	Bits 04-00: Length of the capacity bit mask for the corresponding ResID. Add one to the return value to get the result. Bits 31-05: Reserved.
	EBX	Bits 31-00: Bit-granular map of isolation/contention of allocation units.
	ECX	Bits 01-00: Reserved. Bit 02: CDP. If 1, indicates L2 Code and Data Prioritization Technology is supported. Bit 03: If 1, indicates non-contiguous capacity bitmask is supported. The bits that are set in the various IA32_L2_MASK_n registers do not have to be contiguous. Bits 31-04: Reserved.

**Table 1-3. Information Returned by CPUID Instruction (Continued)**

Initial EAX Value	Information Provided about the Processor	
	EDX	Bits 15-00: Highest COS number supported for this ResID. Bits 31-16: Reserved.
Memory Bandwidth Allocation Asymmetric Enumeration Sub-leaf (Initial EAX Value = 10H, ECX = ResID = 3)		
28H		<b>NOTE:</b> Leaf 28H output depends on the initial value in ECX. Leaf 28H can return different information on each logical processor and software must account for this.
	EAX	Bits 11-00: Reports the maximum MBA throttling value supported for the corresponding ResID. Add one to the return value to get the result. Bits 31-12: Reserved.
	EBX	Bits 31-00: Reserved.
	ECX	Bit 00: Per-thread MBA controls are supported. Bit 01: Reserved. Bit 02: Reports whether the response of the delay values is linear. Bits 31-03: Reserved.
	EDX	Bits 15-00: Highest COS number supported for this ResID. Bits 31-16: Reserved.
Cache Bandwidth Allocation Asymmetric Enumeration Sub-leaf (Initial EAX Value = 10H, ECX = ResID = 5)		
28H		<b>NOTE:</b> Leaf 28H output depends on the initial value in ECX. Leaf 28H can return different information on each logical processor and software must account for this.
	EAX	Bits 07-00: Reports the maximum core throttling level supported for the corresponding ResID. Add one to the return value to get the number of throttling levels supported. Bits 11-08: If 1, indicates the logical processor scope of the IA32_QoS_Core_BW_Thrtl_n MSRs. Other values are reserved. Bits 31-12: Reserved.
	EBX	Bits 31-00: Reserved.
	ECX	Bits 02-00: Reserved. Bit 03: If 1, the response of the bandwidth control is approximately linear. If 0, the response of the bandwidth control is non-linear. Bits 31-04: Reserved.
	EDX	Bits 15-00: Highest Class of Service (COS) number supported for this ResID. Bits 31-16: Reserved.
Unimplemented CPUID Leaf Functions		
21H		Invalid. No existing or future CPU will return processor identification or feature information if the initial EAX value is 21H. If the value returned by CPUID.0:EAX (the maximum input value for basic CPUID information) is at least 21H, 0 is returned in the registers EAX, EBX, ECX, and EDX. Otherwise, the data for the highest basic information leaf is returned.
40000000H – 4FFFFFFFH		Invalid. No existing or future CPU will return processor identification or feature information if the initial EAX value is in the range 40000000H to 4FFFFFFFH.
Extended Function CPUID Information		
80000000H	EAX	Maximum Input Value for Extended Function CPUID Information.
	EBX	Reserved.
	ECX	Reserved.



**Table 1-3. Information Returned by CPUID Instruction (Continued)**

Initial EAX Value	Information Provided about the Processor	
	EDX	Reserved.
80000001H	EAX	Extended Processor Signature and Feature Bits.
	EBX	Reserved.
	ECX	Bit 00: LAHF/SAHF available in 64-bit mode. Bits 04-01: Reserved. Bit 05: LZCNT available. Bits 07-06: Reserved. Bit 08: PREFETCHW. Bits 31-09: Reserved.
	EDX	Bits 10-00: Reserved. Bit 11: SYSCALL/SYSRET available (when in 64-bit mode). Bits 19-12: Reserved = 0. Bit 20: Execute Disable Bit available. Bits 25-21: Reserved = 0. Bit 26: 1-GByte pages are available if 1. Bit 27: RDTSCP and IA32_TSC_AUX are available if 1. Bits 28: Reserved = 0. Bit 29: Intel® 64 Architecture available if 1. Bits 31-30: Reserved = 0.
80000002H	EAX	Processor Brand String.
	EBX	Processor Brand String Continued.
	ECX	Processor Brand String Continued.
	EDX	Processor Brand String Continued.
80000003H	EAX	Processor Brand String Continued.
	EBX	Processor Brand String Continued.
	ECX	Processor Brand String Continued.
	EDX	Processor Brand String Continued.
80000004H	EAX	Processor Brand String Continued.
	EBX	Processor Brand String Continued.
	ECX	Processor Brand String Continued.
	EDX	Processor Brand String Continued.
80000005H	EAX	Reserved = 0.
	EBX	Reserved = 0.
	ECX	Reserved = 0.
	EDX	Reserved = 0.
80000006H	EAX	Reserved = 0.
	EBX	Reserved = 0.
	ECX	Bits 07-00: Cache Line size in bytes. Bits 11-08: Reserved. Bits 15-12: L2 Associativity field.* Bits 31-16: Cache size in 1K units.
	EDX	Reserved = 0.

**Table 1-3. Information Returned by CPUID Instruction (Continued)**

Initial EAX Value	Information Provided about the Processor	
	<p><b>NOTES:</b></p> <p>* L2 associativity field encodings:                      00H - Disabled 08H - 16 ways                      01H - 1 way (direct mapped) 09H - Reserved                      02H - 2 ways 0AH - 32 ways                      03H - Reserved 0BH - 48 ways                      04H - 4 ways 0CH - 64 ways                      05H - Reserved 0DH - 96 ways                      06H - 8 ways 0EH - 128 ways                      07H - See CPUID leaf 04H, sub-leaf 2**0FH - Fully associative</p> <p>** CPUID leaf 04H provides details of deterministic cache parameters, including the L2 cache in sub-leaf 2.</p>	
80000007H	EAX EBX ECX EDX	Reserved = 0. Reserved = 0. Reserved = 0. Bits 07-00: Reserved = 0. Bit 08: Invariant TSC available if 1. Bits 31-09: Reserved = 0.
80000008H	EAX	Virtual/Physical Address Size Bits 07-00: #Physical Address Bits.* Bits 15-08: #Virtual Address Bits. Bits 23-16: #Guest Physical Address Bits. This value applies only to software operating in a virtual machine (Intel processors enumerate this value as zero). When this field is zero, refer to #Physical Address Bits for the number of guest physical address bits. Bits 31-24: Reserved = 0.
	EBX ECX EDX	Bits 08-00: Reserved = 0. Bit 09: WBNOINVD is available if 1. Bits 31-10: Reserved = 0. Reserved = 0. Reserved = 0. <p><b>NOTES:</b></p> <p>* If CPUID.80000008H:EAX[7:0] is supported, the maximum physical address number supported should come from this field. If TME-MK is enabled, the number of bits that can be used to address physical memory is CPUID.80000008H:EAX[7:0] - IA32_TME_ACTIVATE[35:32].</p>

**NOTES:**

1. The logical processor might not be available to report information due to user settings in the operating system or processor based licensing by software.
2. The valid range of fixed-function counters is 0 through 15.
3. Earlier versions of this specification documented these bits as enumerating support for different vector lengths. All processors supporting Intel® AVX10 will include support for all vector lengths.

**INPUT EAX = 0H: Returns CPUID’s Highest Value for Basic Processor Information and the Vendor Identification String**

When CPUID executes with EAX set to 0H, the processor returns the highest value the CPUID recognizes for returning basic processor information. The value is returned in the EAX register and is processor specific.

A vendor identification string is also returned in EBX, EDX, and ECX. For Intel processors, the string is “GenuineIntel” and is expressed:

```
EBX := 756e6547h (* "Genu", with G in the low 4 bits of BL *)
EDX := 49656e69h (* "inel", with i in the low 4 bits of DL *)
ECX := 6c65746eh (* "ntel", with n in the low 4 bits of CL *)
```

**INPUT EAX = 8000000H: Returns CPUID’s Highest Value for Extended Processor Information**

When CPUID executes with EAX set to 0H, the processor returns the highest value the processor recognizes for returning extended processor information. The value is returned in the EAX register and is processor specific.

**IA32\_BIOS\_SIGN\_ID Returns Microcode Update Signature**

For processors that support the microcode update facility, the IA32\_BIOS\_SIGN\_ID MSR is loaded with the update signature whenever CPUID executes. The signature is returned in the upper DWORD. For details, see Chapter 11 in the Intel® 64 and IA-32 Architectures Software Developer’s Manual, Volume 3A.

**INPUT EAX = 01H: Returns Model, Family, Stepping Information**

When CPUID executes with EAX set to 01H, version information is returned in EAX (see Figure 1-1). For example: model, family, and processor type for the Intel Xeon processor 5100 series is as follows:

- Model — 1111B
- Family — 0101B
- Processor Type — 00B

See Table 1-4 for available processor type values. Stepping IDs are provided as needed.

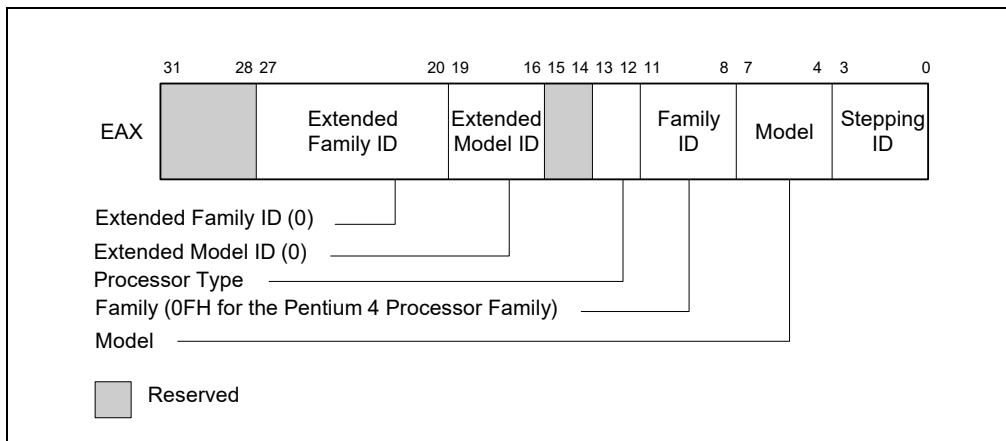

**Figure 1-1. Version Information Returned by CPUID in EAX**

**Table 1-4. Processor Type Field**

Type	Encoding
Original OEM Processor	00B
Intel OverDrive® Processor	01B
Dual processor (not applicable to Intel486 processors)	10B
Intel reserved	11B

**NOTE**

See "Caching Translation Information" in Chapter 5, "Paging," in the Intel® 64 and IA-32 Architectures Software Developer’s Manual, Volume 3A, and Chapter 20 in the Intel® 64 and IA-32 Archi-

processors Software Developer's Manual, Volume 1, for information on identifying earlier IA-32 processors.

The Extended Family ID needs to be examined only when the Family ID is 0FH. Integrate the fields into a display using the following rule:

```
IF Family_ID ≠ 0FH
  THEN Displayed_Family = Family_ID;
  ELSE Displayed_Family = Extended_Family_ID + Family_ID;
FI;
(* Show Display_Family as HEX field. *)
```

The Extended Model ID needs to be examined only when the Family ID is 06H or 0FH. Integrate the field into a display using the following rule:

```
IF (Family_ID = 06H or Family_ID = 0FH)
  THEN Displayed_Model = (Extended_Model_ID << 4) + Model_ID;
  (* Right justify and zero-extend 4-bit field; display Model_ID as HEX field.*)
  ELSE Displayed_Model = Model_ID;
FI;
(* Show Display_Model as HEX field. *)
```

### INPUT EAX = 01H: Returns Additional Information in EBX

When CPUID executes with EAX set to 01H, additional information is returned to the EBX register:

- Brand index (low byte of EBX) — this number provides an entry into a brand string table that contains brand strings for IA-32 processors. More information about this field is provided later in this section.
- CLFLUSH instruction cache line size (second byte of EBX) — this number indicates the size of the cache line flushed with CLFLUSH instruction in 8-byte increments. This field was introduced in the Pentium 4 processor.
- Local APIC ID (high byte of EBX) — this number is the 8-bit ID that is assigned to the local APIC on the processor during power up. This field was introduced in the Pentium 4 processor.

### INPUT EAX = 01H: Returns Feature Information in ECX and EDX

When CPUID executes with EAX set to 01H, feature information is returned in ECX and EDX.

- Figure 1-2 and Table 1-5 show encodings for ECX.
- Figure 1-3 and Table 1-6 show encodings for EDX.

For all feature flags, a 1 indicates that the feature is supported. Use Intel to properly interpret feature flags.

### NOTE

Software must confirm that a processor feature is present using feature flags returned by CPUID prior to using the feature. Software should not depend on future offerings retaining all features.

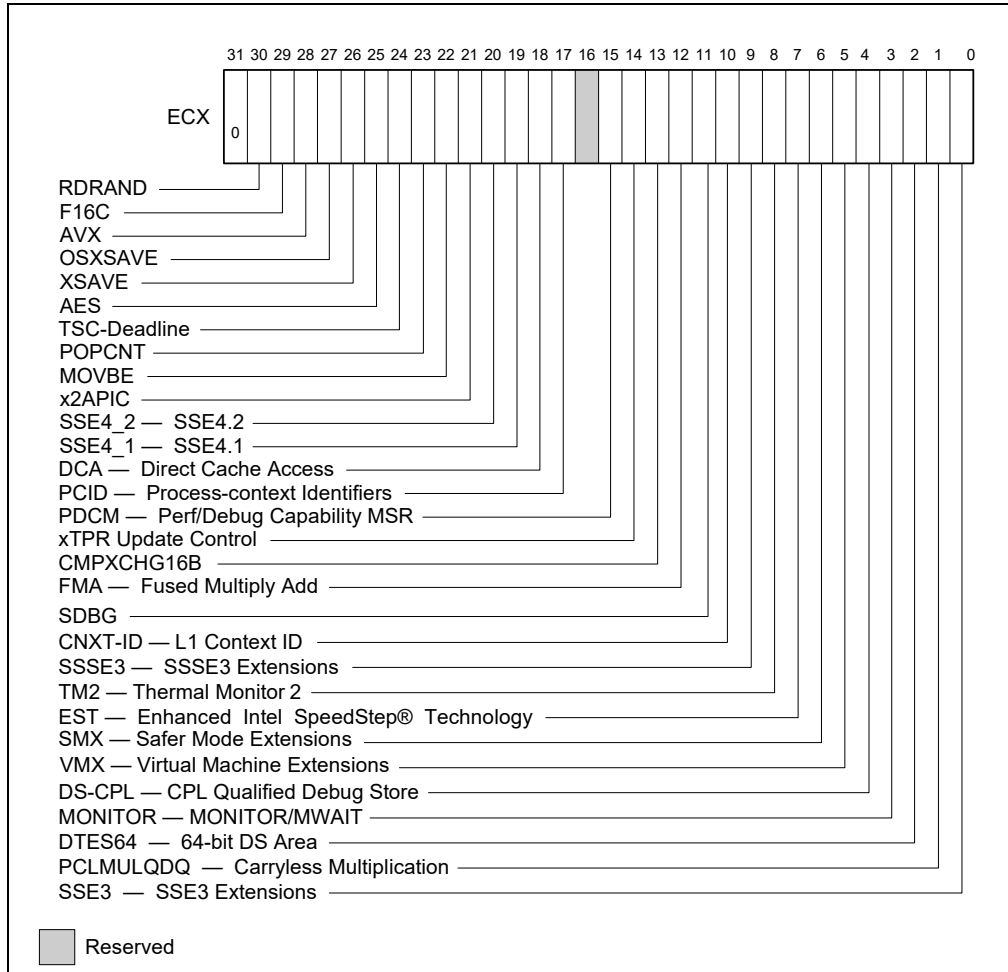

Figure 1-2. Feature Information Returned in the ECX Register

Table 1-5. Feature Information Returned in the ECX Register

Bit #	Mnemonic	Description
0	SSE3	<b>Intel® Streaming SIMD Extensions 3 (Intel® SSE3).</b> A value of 1 indicates the processor supports this technology.
1	PCLMULQDQ	A value of 1 indicates the processor supports the PCLMULQDQ instruction.
2	DTE64	<b>64-bit DS Area.</b> A value of 1 indicates the processor supports DS area using 64-bit layout.
3	MONITOR	<b>MONITOR/MWAIT.</b> A value of 1 indicates the processor supports this feature.
4	DS-CPL	<b>CPL Qualified Debug Store.</b> A value of 1 indicates the processor supports the extensions to the Debug Store feature to allow for branch message storage qualified by CPL.
5	VMX	<b>Virtual Machine Extensions.</b> A value of 1 indicates that the processor supports this technology.
6	SMX	<b>Safer Mode Extensions.</b> A value of 1 indicates that the processor supports this technology. See Chapter 7, “Safer Mode Extensions Reference.”
7	EST	<b>Enhanced Intel SpeedStep® Technology.</b> A value of 1 indicates that the processor supports this technology.
8	TM2	<b>Thermal Monitor 2.</b> A value of 1 indicates whether the processor supports this technology.
9	SSSE3	A value of 1 indicates the presence of the Supplemental Streaming SIMD Extensions 3 (SSSE3). A value of 0 indicates the instruction extensions are not present in the processor.

Table 1-5. Feature Information Returned in the ECX Register (Continued)

Bit #	Mnemonic	Description
10	CNXT-ID	<b>L1 Context ID.</b> A value of 1 indicates the L1 data cache mode can be set to either adaptive mode or shared mode. A value of 0 indicates this feature is not supported. See definition of the IA32_MISC_ENABLE MSR Bit 24 (L1 Data Cache Context Mode) for details.
11	SDBG	A value of 1 indicates the processor supports IA32_DEBUG_INTERFACE MSR for silicon debug.
12	FMA	A value of 1 indicates the processor supports FMA extensions using YMM state.
13	CMPXCHG16B	<b>CMPXCHG16B Available.</b> A value of 1 indicates that the feature is available.
14	xTPR Update Control	<b>xTPR Update Control.</b> A value of 1 indicates that the processor supports changing IA32_MISC_ENABLE[bit 23].
15	PDCM	<b>PerfMon and Debug Capability.</b> A value of 1 indicates the processor supports the performance and debug feature indication MSR IA32_PERF_CAPABILITIES.
16	Reserved	Reserved.
17	PCID	<b>Process-context identifiers.</b> A value of 1 indicates that the processor supports PCIDs and that software may set CR4.PCIDE to 1.
18	DCA	A value of 1 indicates the processor supports the ability to prefetch data from a memory mapped device.
19	SSE4.1	A value of 1 indicates that the processor supports SSE4.1.
20	SSE4.2	A value of 1 indicates that the processor supports SSE4.2.
21	x2APIC	A value of 1 indicates that the processor supports x2APIC feature.
22	MOVBE	A value of 1 indicates that the processor supports MOVBE instruction.
23	POPCNT	A value of 1 indicates that the processor supports the POPCNT instruction.
24	TSC-Deadline	A value of 1 indicates that the processor's local APIC timer supports one-shot operation using a TSC deadline value.
25	AES	A value of 1 indicates that the processor supports the AESNI instruction extensions.
26	XSAVE	A value of 1 indicates that the processor supports the XSAVE/XRSTOR processor extended states feature, the XSETBV/XGETBV instructions, and XCRO.
27	OSXSAVE	A value of 1 indicates that the OS has set CR4.OSXSAVE[bit 18] to enable XSETBV/XGETBV instructions to access XCRO and to support processor extended state management using XSAVE/XRSTOR.
28	AVX	A value of 1 indicates that processor supports AVX instructions operating on 256-bit YMM state, and three-operand encoding of 256-bit and 128-bit SIMD instructions.
29	F16C	A value of 1 indicates that processor supports 16-bit floating-point conversion instructions.
30	RDRAND	A value of 1 indicates that processor supports RDRAND instruction.
31	Not Used	Always return 0.

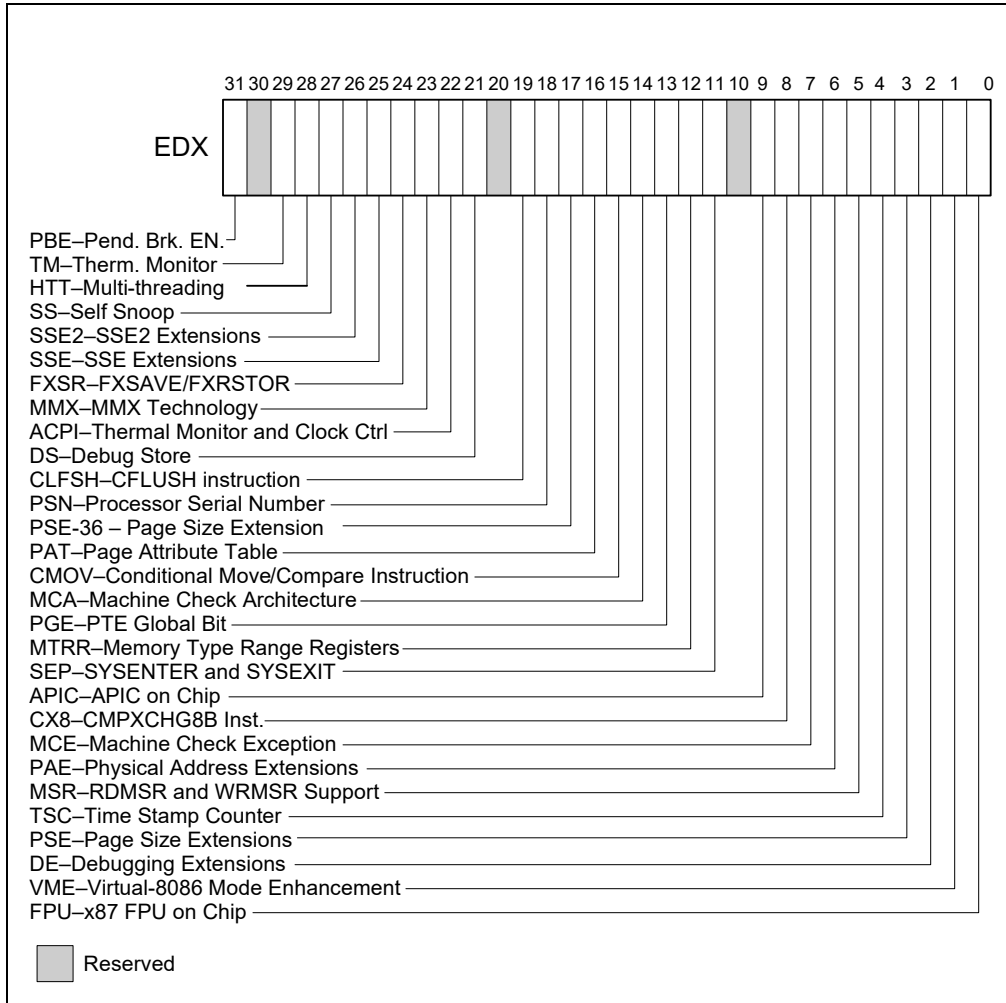

Figure 1-3. Feature Information Returned in the EDX Register

Table 1-6. More on Feature Information Returned in the EDX Register

Bit #	Mnemonic	Description
0	FPU	<b>Floating-point Unit On-Chip.</b> The processor contains an x87 FPU.
1	VME	<b>Virtual 8086 Mode Enhancements.</b> Virtual 8086 mode enhancements, including CR4.VME for controlling the feature, CR4.PVI for protected mode virtual interrupts, software interrupt indirection, expansion of the TSS with the software indirection bitmap, and EFLAGS.VIF and EFLAGS.VIP flags.
2	DE	<b>Debugging Extensions.</b> Support for I/O breakpoints, including CR4.DE for controlling the feature, and optional trapping of accesses to DR4 and DR5.
3	PSE	<b>Page Size Extension.</b> Large pages of size 4 MByte are supported, including CR4.PSE for controlling the feature, the defined dirty bit in PDE (Page Directory Entries), optional reserved bit trapping in CR3, PDEs, and PTEs.
4	TSC	<b>Time Stamp Counter.</b> The RDTSC instruction is supported, including CR4.TSD for controlling privilege.
5	MSR	<b>Model Specific Registers RDMSR and WRMSR Instructions.</b> The RDMSR and WRMSR instructions are supported. Some of the MSRs are implementation dependent.

Table 1-6. More on Feature Information Returned in the EDX Register (Continued)

Bit #	Mnemonic	Description
6	PAE	<b>Physical Address Extension.</b> Physical addresses greater than 32 bits are supported: extended page table entry formats, an extra level in the page translation tables is defined, 2-MByte pages are supported instead of 4 Mbyte pages if PAE bit is 1. The actual number of address bits beyond 32 is not defined, and is implementation specific.
7	MCE	<b>Machine Check Exception.</b> Exception 18 is defined for Machine Checks, including CR4.MCE for controlling the feature. This feature does not define the model-specific implementations of machine-check error logging, reporting, and processor shutdowns. Machine Check exception handlers may have to depend on processor version to do model specific processing of the exception, or test for the presence of the Machine Check feature.
8	CX8	<b>CMPXCHG8B Instruction.</b> The compare-and-exchange 8 bytes (64 bits) instruction is supported (implicitly locked and atomic).
9	APIC	<b>APIC On-Chip.</b> The processor contains an Advanced Programmable Interrupt Controller (APIC), responding to memory mapped commands in the physical address range FFFE0000H to FFFE0FFFH (by default - some processors permit the APIC to be relocated).
10	Reserved	Reserved.
11	SEP	<b>SYSENTER and SYSEXIT Instructions.</b> The SYSENTER and SYSEXIT and associated MSRs are supported.
12	MTRR	<b>Memory Type Range Registers.</b> MTRRs are supported. The MTRRcap MSR contains feature bits that describe what memory types are supported, how many variable MTRRs are supported, and whether fixed MTRRs are supported.
13	PGE	<b>Page Global Bit.</b> The global bit is supported in paging-structure entries that map a page, indicating TLB entries that are common to different processes and need not be flushed. The CR4.PGE bit controls this feature.
14	MCA	<b>Machine Check Architecture.</b> The Machine Check Architecture, which provides a compatible mechanism for error reporting in P6 family, Pentium 4, Intel Xeon processors, and future processors, is supported. The MCG_CAP MSR contains feature bits describing how many banks of error reporting MSRs are supported.
15	CMOV	<b>Conditional Move Instructions.</b> The conditional move instruction CMOV is supported. In addition, if x87 FPU is present as indicated by the CPUID.FPU feature bit, then the FCOMI and FCMOV instructions are supported
16	PAT	<b>Page Attribute Table.</b> Page Attribute Table is supported. This feature augments the Memory Type Range Registers (MTRRs), allowing an operating system to specify attributes of memory accessed through a linear address on a 4KB granularity.
17	PSE-36	<b>36-Bit Page Size Extension.</b> 4-MByte pages addressing physical memory beyond 4 GBytes are supported with 32-bit paging. This feature indicates that upper bits of the physical address of a 4-MByte page are encoded in bits 20:13 of the page-directory entry. Such physical addresses are limited by MAXPHYADDR and may be up to 40 bits in size.
18	PSN	<b>Processor Serial Number.</b> The processor supports the 96-bit processor identification number feature and the feature is enabled.
19	CLFSH	<b>CLFLUSH Instruction.</b> CLFLUSH Instruction is supported.
20	Reserved	Reserved.
21	DS	<b>Debug Store.</b> The processor supports the ability to write debug information into a memory resident buffer. This feature is used by the branch trace store (BTS) and precise event-based sampling (PEBS) facilities (see Chapter 25, "Introduction to Virtual-Machine Extensions," in the Intel® 64 and IA-32 Architectures Software Developer's Manual, Volume 3C).
22	ACPI	<b>Thermal Monitor and Software Controlled Clock Facilities.</b> The processor implements internal MSRs that allow processor temperature to be monitored and processor performance to be modulated in predefined duty cycles under software control.
23	MMX	<b>Intel MMX Technology.</b> The processor supports the Intel MMX technology.



**Table 1-6. More on Feature Information Returned in the EDX Register (Continued)**

Bit #	Mnemonic	Description
24	FXSR	<b>FXSAVE and FXRSTOR Instructions.</b> The FXSAVE and FXRSTOR instructions are supported for fast save and restore of the floating-point context. Presence of this bit also indicates that CR4.OSFXSR is available for an operating system to indicate that it supports the FXSAVE and FXRSTOR instructions.
25	SSE	<b>SSE.</b> The processor supports the SSE extensions.
26	SSE2	<b>SSE2.</b> The processor supports the SSE2 extensions.
27	SS	<b>Self Snoop.</b> The processor supports the management of conflicting memory types by performing a snoop of its own cache structure for transactions issued to the bus.
28	HTT	<b>Max APIC IDs reserved field is Valid.</b> A value of 0 for HTT indicates there is only a single logical processor in the package and software should assume only a single APIC ID is reserved. A value of 1 for HTT indicates the value in CPUID.1.EBX[23:16] (the Maximum number of addressable IDs for logical processors in this package) is valid for the package.
29	TM	<b>Thermal Monitor.</b> The processor implements the thermal monitor automatic thermal control circuitry (TCC).
30	Reserved	Reserved.
31	PBE	<b>Pending Break Enable.</b> The processor supports the use of the FERR#/PBE# pin when the processor is in the stop-clock state (STPCLK# is asserted) to signal the processor that an interrupt is pending and that the processor should return to normal operation to handle the interrupt. Bit 10 (PBE enable) in the IA32_MISC_ENABLE MSR enables this capability.

**INPUT EAX = 02H: Cache and TLB Information Returned in EAX, EBX, ECX, EDX**

When CPUID executes with EAX set to 02H, the processor returns information about the processor's internal caches and TLBs in the EAX, EBX, ECX, and EDX registers.

The encoding is as follows:

- The least-significant byte in register EAX (register AL) indicates the number of times the CPUID instruction must be executed with an input value of 02H to get a complete description of the processor's caches and TLBs. The first member of the family of Pentium 4 processors will return a 01H.
- The most significant bit (bit 31) of each register indicates whether the register contains valid information (set to 0) or is reserved (set to 1).
- If a register contains valid information, the information is contained in 1 byte descriptors. Table 1-7 shows the encoding of these descriptors. Note that the order of descriptors in the EAX, EBX, ECX, and EDX registers is not defined; that is, specific bytes are not designated to contain descriptors for specific cache or TLB types. The descriptors may appear in any order.

**Table 1-7. Encoding of CPUID Leaf 2 Descriptors**

Descriptor Value	Type	Cache or TLB Description
00H	General	Null descriptor, this byte contains no information.
01H	TLB	Instruction TLB: 4 KByte pages, 4-way set associative, 32 entries.
02H	TLB	Instruction TLB: 4 MByte pages, fully associative, 2 entries.
03H	TLB	Data TLB: 4 KByte pages, 4-way set associative, 64 entries.
04H	TLB	Data TLB: 4 MByte pages, 4-way set associative, 8 entries.
05H	TLB	Data TLB1: 4 MByte pages, 4-way set associative, 32 entries.
06H	Cache	1st-level instruction cache: 8 KBytes, 4-way set associative, 32 byte line size.
08H	Cache	1st-level instruction cache: 16 KBytes, 4-way set associative, 32 byte line size.
09H	Cache	1st-level instruction cache: 32KBytes, 4-way set associative, 64 byte line size.
0AH	Cache	1st-level data cache: 8 KBytes, 2-way set associative, 32 byte line size.

Table 1-7. Encoding of CPUID Leaf 2 Descriptors (Continued)

Descriptor Value	Type	Cache or TLB Description
0BH	TLB	Instruction TLB: 4 MByte pages, 4-way set associative, 4 entries.
0CH	Cache	1st-level data cache: 16 KBytes, 4-way set associative, 32 byte line size.
0DH	Cache	1st-level data cache: 16 KBytes, 4-way set associative, 64 byte line size.
0EH	Cache	1st-level data cache: 24 KBytes, 6-way set associative, 64 byte line size.
1DH	Cache	2nd-level cache: 128 KBytes, 2-way set associative, 64 byte line size.
21H	Cache	2nd-level cache: 256 KBytes, 8-way set associative, 64 byte line size.
22H	Cache	3rd-level cache: 512 KBytes, 4-way set associative, 64 byte line size, 2 lines per sector.
23H	Cache	3rd-level cache: 1 MBytes, 8-way set associative, 64 byte line size, 2 lines per sector.
24H	Cache	2nd-level cache: 1 MBytes, 16-way set associative, 64 byte line size.
25H	Cache	3rd-level cache: 2 MBytes, 8-way set associative, 64 byte line size, 2 lines per sector.
29H	Cache	3rd-level cache: 4 MBytes, 8-way set associative, 64 byte line size, 2 lines per sector.
2CH	Cache	1st-level data cache: 32 KBytes, 8-way set associative, 64 byte line size.
30H	Cache	1st-level instruction cache: 32 KBytes, 8-way set associative, 64 byte line size.
40H	Cache	No 2nd-level cache or, if processor contains a valid 2nd-level cache, no 3rd-level cache.
41H	Cache	2nd-level cache: 128 KBytes, 4-way set associative, 32 byte line size.
42H	Cache	2nd-level cache: 256 KBytes, 4-way set associative, 32 byte line size.
43H	Cache	2nd-level cache: 512 KBytes, 4-way set associative, 32 byte line size.
44H	Cache	2nd-level cache: 1 MByte, 4-way set associative, 32 byte line size.
45H	Cache	2nd-level cache: 2 MByte, 4-way set associative, 32 byte line size.
46H	Cache	3rd-level cache: 4 MByte, 4-way set associative, 64 byte line size.
47H	Cache	3rd-level cache: 8 MByte, 8-way set associative, 64 byte line size.
48H	Cache	2nd-level cache: 3MByte, 12-way set associative, 64 byte line size.
49H	Cache	3rd-level cache: 4MB, 16-way set associative, 64-byte line size (Intel Xeon processor MP, Family 0FH, Model 06H); 2nd-level cache: 4 MByte, 16-way set associative, 64 byte line size.
4AH	Cache	3rd-level cache: 6MByte, 12-way set associative, 64 byte line size.
4BH	Cache	3rd-level cache: 8MByte, 16-way set associative, 64 byte line size.
4CH	Cache	3rd-level cache: 12MByte, 12-way set associative, 64 byte line size.
4DH	Cache	3rd-level cache: 16MByte, 16-way set associative, 64 byte line size.
4EH	Cache	2nd-level cache: 6MByte, 24-way set associative, 64 byte line size.
4FH	TLB	Instruction TLB: 4 KByte pages, 32 entries.
50H	TLB	Instruction TLB: 4 KByte and 2-MByte or 4-MByte pages, 64 entries.
51H	TLB	Instruction TLB: 4 KByte and 2-MByte or 4-MByte pages, 128 entries.
52H	TLB	Instruction TLB: 4 KByte and 2-MByte or 4-MByte pages, 256 entries.
55H	TLB	Instruction TLB: 2-MByte or 4-MByte pages, fully associative, 7 entries.
56H	TLB	Data TLB0: 4 MByte pages, 4-way set associative, 16 entries.
57H	TLB	Data TLB0: 4 KByte pages, 4-way associative, 16 entries.
59H	TLB	Data TLB0: 4 KByte pages, fully associative, 16 entries.
5AH	TLB	Data TLB0: 2 MByte or 4 MByte pages, 4-way set associative, 32 entries.
5BH	TLB	Data TLB: 4 KByte and 4 MByte pages, 64 entries.
5CH	TLB	Data TLB: 4 KByte and 4 MByte pages, 128 entries.

**Table 1-7. Encoding of CPUID Leaf 2 Descriptors (Continued)**

Descriptor Value	Type	Cache or TLB Description
5DH	TLB	Data TLB: 4 KByte and 4 MByte pages, 256 entries.
60H	Cache	1st-level data cache: 16 KByte, 8-way set associative, 64 byte line size.
61H	TLB	Instruction TLB: 4 KByte pages, fully associative, 48 entries.
63H	TLB	Data TLB: 2 MByte or 4 MByte pages, 4-way set associative, 32 entries and a separate array with 1 GByte pages, 4-way set associative, 4 entries.
64H	TLB	Data TLB: 4 KByte pages, 4-way set associative, 512 entries.
66H	Cache	1st-level data cache: 8 KByte, 4-way set associative, 64 byte line size.
67H	Cache	1st-level data cache: 16 KByte, 4-way set associative, 64 byte line size.
68H	Cache	1st-level data cache: 32 KByte, 4-way set associative, 64 byte line size.
6AH	Cache	uTLB: 4 KByte pages, 8-way set associative, 64 entries.
6BH	Cache	DTLB: 4 KByte pages, 8-way set associative, 256 entries.
6CH	Cache	DTLB: 2M/4M pages, 8-way set associative, 128 entries.
6DH	Cache	DTLB: 1 GByte pages, fully associative, 16 entries.
70H	Cache	Trace cache: 12 K-μop, 8-way set associative.
71H	Cache	Trace cache: 16 K-μop, 8-way set associative.
72H	Cache	Trace cache: 32 K-μop, 8-way set associative.
76H	TLB	Instruction TLB: 2M/4M pages, fully associative, 8 entries.
78H	Cache	2nd-level cache: 1 MByte, 4-way set associative, 64byte line size.
79H	Cache	2nd-level cache: 128 KByte, 8-way set associative, 64 byte line size, 2 lines per sector.
7AH	Cache	2nd-level cache: 256 KByte, 8-way set associative, 64 byte line size, 2 lines per sector.
7BH	Cache	2nd-level cache: 512 KByte, 8-way set associative, 64 byte line size, 2 lines per sector.
7CH	Cache	2nd-level cache: 1 MByte, 8-way set associative, 64 byte line size, 2 lines per sector.
7DH	Cache	2nd-level cache: 2 MByte, 8-way set associative, 64byte line size.
7FH	Cache	2nd-level cache: 512 KByte, 2-way set associative, 64-byte line size.
80H	Cache	2nd-level cache: 512 KByte, 8-way set associative, 64-byte line size.
82H	Cache	2nd-level cache: 256 KByte, 8-way set associative, 32 byte line size.
83H	Cache	2nd-level cache: 512 KByte, 8-way set associative, 32 byte line size.
84H	Cache	2nd-level cache: 1 MByte, 8-way set associative, 32 byte line size.
85H	Cache	2nd-level cache: 2 MByte, 8-way set associative, 32 byte line size.
86H	Cache	2nd-level cache: 512 KByte, 4-way set associative, 64 byte line size.
87H	Cache	2nd-level cache: 1 MByte, 8-way set associative, 64 byte line size.
A0H	DTLB	DTLB: 4k pages, fully associative, 32 entries.
B0H	TLB	Instruction TLB: 4 KByte pages, 4-way set associative, 128 entries.
B1H	TLB	Instruction TLB: 2M pages, 4-way, 8 entries or 4M pages, 4-way, 4 entries.
B2H	TLB	Instruction TLB: 4KByte pages, 4-way set associative, 64 entries.
B3H	TLB	Data TLB: 4 KByte pages, 4-way set associative, 128 entries.
B4H	TLB	Data TLB1: 4 KByte pages, 4-way associative, 256 entries.
B5H	TLB	Instruction TLB: 4KByte pages, 8-way set associative, 64 entries.
B6H	TLB	Instruction TLB: 4KByte pages, 8-way set associative, 128 entries.
BAH	TLB	Data TLB1: 4 KByte pages, 4-way associative, 64 entries.
COH	TLB	Data TLB: 4 KByte and 4 MByte pages, 4-way associative, 8 entries.

**Table 1-7. Encoding of CPUID Leaf 2 Descriptors (Continued)**

Descriptor Value	Type	Cache or TLB Description
C1H	STLB	Shared 2nd-Level TLB: 4 KByte/2MByte pages, 8-way associative, 1024 entries.
C2H	DTLB	DTLB: 4 KByte/2 MByte pages, 4-way associative, 16 entries.
C3H	STLB	Shared 2nd-Level TLB: 4 KByte /2 MByte pages, 6-way associative, 1536 entries. Also 1GByte pages, 4-way, 16 entries.
C4H	DTLB	DTLB: 2M/4M Byte pages, 4-way associative, 32 entries.
CAH	STLB	Shared 2nd-Level TLB: 4 KByte pages, 4-way associative, 512 entries.
D0H	Cache	3rd-level cache: 512 KByte, 4-way set associative, 64 byte line size.
D1H	Cache	3rd-level cache: 1 MByte, 4-way set associative, 64 byte line size.
D2H	Cache	3rd-level cache: 2 MByte, 4-way set associative, 64 byte line size.
D6H	Cache	3rd-level cache: 1 MByte, 8-way set associative, 64 byte line size.
D7H	Cache	3rd-level cache: 2 MByte, 8-way set associative, 64 byte line size.
D8H	Cache	3rd-level cache: 4 MByte, 8-way set associative, 64 byte line size.
DCH	Cache	3rd-level cache: 1.5 MByte, 12-way set associative, 64 byte line size.
DDH	Cache	3rd-level cache: 3 MByte, 12-way set associative, 64 byte line size.
DEH	Cache	3rd-level cache: 6 MByte, 12-way set associative, 64 byte line size.
E2H	Cache	3rd-level cache: 2 MByte, 16-way set associative, 64 byte line size.
E3H	Cache	3rd-level cache: 4 MByte, 16-way set associative, 64 byte line size.
E4H	Cache	3rd-level cache: 8 MByte, 16-way set associative, 64 byte line size.
EAH	Cache	3rd-level cache: 12MByte, 24-way set associative, 64 byte line size.
EBH	Cache	3rd-level cache: 18MByte, 24-way set associative, 64 byte line size.
ECH	Cache	3rd-level cache: 24MByte, 24-way set associative, 64 byte line size.
FOH	Prefetch	64-Byte prefetching.
F1H	Prefetch	128-Byte prefetching.
FEH	General	CPUID leaf 2 does not report TLB descriptor information; use CPUID leaf 18H to query TLB and other address translation parameters.
FFH	General	CPUID leaf 2 does not report cache descriptor information, use CPUID leaf 4 to query cache parameters.

**Example 1-1. Example of Cache and TLB Interpretation**

The first member of the family of Pentium 4 processors returns the following information about caches and TLBs when the CPUID executes with an input value of 2:

```
EAX    66 5B 50 01H
EBX    0H
ECX    0H
EDX    00 7A 70 00H
```

Which means:

- The least-significant byte (byte 0) of register EAX is set to 01H. This indicates that CPUID needs to be executed once with an input value of 2 to retrieve complete information about caches and TLBs.
- The most-significant bit of all four registers (EAX, EBX, ECX, and EDX) is set to 0, indicating that each register contains valid 1-byte descriptors.
- Bytes 1, 2, and 3 of register EAX indicate that the processor has:
  - 50H - a 64-entry instruction TLB, for mapping 4-KByte and 2-MByte or 4-MByte pages.
  - 5BH - a 64-entry data TLB, for mapping 4-KByte and 4-MByte pages.

- 66H - an 8-KByte 1st level data cache, 4-way set associative, with a 64-Byte cache line size.
- The descriptors in registers EBX and ECX are valid, but contain NULL descriptors.
- Bytes 0, 1, 2, and 3 of register EDX indicate that the processor has:
  - 00H - NULL descriptor.
  - 70H - Trace cache: 12 K- $\mu$ op, 8-way set associative.
  - 7AH - a 256-KByte 2nd level cache, 8-way set associative, with a sectored, 64-byte cache line size.
  - 00H - NULL descriptor.

### INPUT EAX = 04H: Returns Deterministic Cache Parameters for Each Level

When CPUID executes with EAX set to 04H and ECX contains an index value, the processor returns encoded data that describe a set of deterministic cache parameters (for the cache level associated with the input in ECX). Valid index values start from 0.

Software can enumerate the deterministic cache parameters for each level of the cache hierarchy starting with an index value of 0, until the parameters report the value associated with the cache type field is 0. The architecturally defined fields reported by deterministic cache parameters are documented in Table 1-3.

The CPUID leaf 4 also reports data that can be used to derive the topology of processor cores in a physical package. This information is constant for all valid index values. Software can query the raw data reported by executing CPUID with EAX=04H and ECX=0H and use it as part of the topology enumeration algorithm described in Chapter 10, "Multiple-Processor Management," in the Intel® 64 and IA-32 Architectures Software Developer's Manual, Volume 3A.

### INPUT EAX = 05H: Returns MONITOR and MWAIT Features

When CPUID executes with EAX set to 05H, the processor returns information about features available to MONITOR/MWAIT instructions. The MONITOR instruction is used for address-range monitoring in conjunction with MWAIT instruction. The MWAIT instruction optionally provides additional extensions for advanced power management. See Table 1-3.

### INPUT EAX = 06H: Returns Thermal and Power Management Features

When CPUID executes with EAX set to 06H, the processor returns information about thermal and power management features. See Table 1-3.

### INPUT EAX = 07H: Returns Structured Extended Feature Enumeration Information

When CPUID executes with EAX set to 07H and ECX = 0H, the processor returns information about the maximum number of sub-leaves that contain extended feature flags. See Table 1-3.

When CPUID executes with EAX set to 07H and ECX =  $n$  ( $n \geq 1$  and less than the number of non-zero bits in CPUID.(EAX=07H, ECX= 0H).EAX), the processor returns information about extended feature flags. See Table 1-3. In sub-leaf 0, only EAX has the number of sub-leaves. In sub-leaf 0, EBX, ECX & EDX all contain extended feature flags.

### INPUT EAX = 09H: Returns Direct Cache Access Information

When CPUID executes with EAX set to 09H, the processor returns information about Direct Cache Access capabilities. See Table 1-3.

### INPUT EAX = 0AH: Returns Architectural Performance Monitoring Features

When CPUID executes with EAX set to 0AH, the processor returns information about support for architectural performance monitoring capabilities. Architectural performance monitoring is supported if the version ID (see Table 1-3) is greater than Pn 0. See Table 1-3.

For each version of architectural performance monitoring capability, software must enumerate this leaf to discover the programming facilities and the architectural performance events available in the processor. The details are

described in Chapter 19, “Debug, Branch Profile, TSC, and Intel® Resource Director Technology (Intel® RDT) Features,” in the Intel® 64 and IA-32 Architectures Software Developer’s Manual, Volume 3A.

### INPUT EAX = 0BH: Returns Extended Topology Information

*CPUID leaf 1FH is a preferred superset to leaf 0BH. Intel recommends first checking for the existence of Leaf 1FH before using leaf 0BH.*

When CPUID executes with EAX set to 0BH, the processor returns information about extended topology enumeration data. Software must detect the presence of CPUID leaf 0BH by verifying (a) the highest leaf index supported by CPUID is  $\geq 0BH$ , and (b) CPUID.0BH:EBX[15:0] reports a non-zero value. See Table 1-3.

### INPUT EAX = 0DH: Returns Processor Extended States Enumeration Information

When CPUID executes with EAX set to 0DH and ECX = 0H, the processor returns information about the bit-vector representation of all processor state extensions that are supported in the processor and storage size requirements of the XSAVE/XRSTOR area. See Table 1-3.

When CPUID executes with EAX set to 0DH and ECX = n (n > 1, and is a valid sub-leaf index), the processor returns information about the size and offset of each processor extended state save area within the XSAVE/XRSTOR area. See Table 1-3. Software can use the forward-extendable technique depicted below to query the valid sub-leaves and obtain size and offset information for each processor extended state save area:

```
For i = 2 to 62 // sub-leaf 1 is reserved
  IF (CPUID.(EAX=0DH, ECX=0):VECTOR[i] = 1) // VECTOR is the 64-bit value of EDX:EAX
    Execute CPUID.(EAX=0DH, ECX = i) to examine size and offset for sub-leaf i;
  FI;
```

### INPUT EAX = 0FH: Returns Intel Resource Director Technology (Intel RDT) Monitoring Enumeration Information

When CPUID executes with EAX set to 0FH and ECX = 0, the processor returns information about the bit-vector representation of QoS monitoring resource types that are supported in the processor and maximum range of RMID values the processor can use to monitor of any supported resource types. Each bit, starting from bit 1, corresponds to a specific resource type if the bit is set. The bit position corresponds to the sub-leaf index (or ResID) that software must use to query QoS monitoring capability available for that type. See Table 1-3.

When CPUID executes with EAX set to 0FH and ECX = n (n  $\geq$  1, and is a valid ResID), the processor returns information software can use to program IA32\_PQR\_ASSOC, IA32\_QM\_EVTSEL MSRs before reading QoS data from the IA32\_QM\_CTR MSR.

### INPUT EAX = 10H: Returns Intel Resource Director Technology (Intel RDT) Allocation Enumeration Information

When CPUID executes with EAX set to 10H and ECX = 0, the processor returns information about the bit-vector representation of QoS Enforcement resource types that are supported in the processor. Each bit, starting from bit 1, corresponds to a specific resource type if the bit is set. The bit position corresponds to the sub-leaf index (or ResID) that software must use to query QoS enforcement capability available for that type. See Table 1-3.

When CPUID executes with EAX set to 10H and ECX = n (n  $\geq$  1, and is a valid ResID), the processor returns information about available classes of service and range of QoS mask MSRs that software can use to configure each class of services using capability bit masks in the QoS Mask registers, IA32\_resourceType\_Mask\_n.

### INPUT EAX = 12H: Returns Intel SGX Enumeration Information

When CPUID executes with EAX set to 12H and ECX = 0H, the processor returns information about Intel SGX capabilities. See Table 1-3.

When CPUID executes with EAX set to 12H and ECX = 1H, the processor returns information about Intel SGX attributes. See Table 1-3.

When CPUID executes with EAX set to 12H and ECX = n (n > 1), the processor returns information about Intel SGX Enclave Page Cache. See Table 1-3.

**INPUT EAX = 14H: Returns Intel Processor Trace Enumeration Information**

When CPUID executes with EAX set to 14H and ECX = 0H, the processor returns information about Intel Processor Trace extensions. See Table 1-3.

When CPUID executes with EAX set to 14H and ECX = n (n > 0 and less than the number of non-zero bits in CPUID.(EAX=14H, ECX= 0H).EAX), the processor returns information about packet generation in Intel Processor Trace. See Table 1-3.

**INPUT EAX = 15H: Returns Time Stamp Counter and Nominal Core Crystal Clock Information**

When CPUID executes with EAX set to 15H and ECX = 0H, the processor returns information about Time Stamp Counter and Core Crystal Clock. See Table 1-3.

**INPUT EAX = 16H: Returns Processor Frequency Information**

When CPUID executes with EAX set to 16H, the processor returns information about Processor Frequency Information. See Table 1-3.

**INPUT EAX = 17H: Returns System-On-Chip Information**

When CPUID executes with EAX set to 17H, the processor returns information about the System-On-Chip Vendor Attribute Enumeration. See Table 1-3.

**INPUT EAX = 18H: Returns Deterministic Address Translation Parameters Information**

When CPUID executes with EAX set to 18H, the processor returns information about the Deterministic Address Translation Parameters. See Table 1-3.

**INPUT EAX = 19H: Returns Key Locker Information**

When CPUID executes with EAX set to 19H, the processor returns information about Key Locker. See Table 1-3.

**INPUT EAX = 1AH: Returns Hybrid Information**

When CPUID executes with EAX set to 1AH, the processor returns information about hybrid capabilities. See Table 1-3.

**INPUT EAX = 1BH: Returns PCONFIG Information**

When CPUID executes with EAX set to 1BH, the processor returns information about PCONFIG capabilities. This information is enumerated in sub-leaves selected by the value of ECX (starting with 0).

Each sub-leaf of CPUID function 1BH enumerates its sub-leaf type in EAX. If a sub-leaf type is 0, the sub-leaf is invalid and zero is returned in EBX, ECX, and EDX. In this case, all subsequent sub-leaves (selected by larger input values of ECX) are also invalid.

The only valid sub-leaf type currently defined is 1, indicating that the sub-leaf enumerates target identifiers for the PCONFIG instruction. Any non-zero value returned in EBX, ECX, or EDX indicates a valid target identifier of the PCONFIG instruction (any value of zero should be ignored). Currently, TME-MK and TSE are the only defined targets. TME-MK is indicated by identifier 1, and TSE is indicated by identifier 2. An identifier of 0 indicates an invalid target. If TME-MK is a supported target, the MKTME\_KEY\_PROGRAM leaf of PCONFIG is available. If TSE is a supported target, the TSE\_KEY\_PROGRAM and the TSE\_KEY\_PROGRAM\_WRAPPED leaves of PCONFIG are available. See the "PCONFIG-Platform Configuration" instruction in Chapter 4 of the Intel® 64 and IA 32 Architectures Software Developer's Manual, Volume 2B, for more information.

**INPUT EAX = 1CH: Returns Last Branch Record Information**

When CPUID executes with EAX set to 1CH, the processor returns information about LBRs (the architectural feature). See Table 1-3.

### **INPUT EAX = 1DH: Returns Tile Information**

When CPUID executes with EAX set to 1DH and ECX = 0H, the processor returns information about tile architecture. See Table 1-3.

When CPUID executes with EAX set to 1DH and ECX = 1H, the processor returns information about tile palette 1. See Table 1-3.

### **INPUT EAX = 1EH: Returns TMUL Information**

When CPUID executes with EAX set to 1EH, the processor returns information about TMUL capabilities. See Table 1-3.

### **INPUT EAX = 1FH: Returns V2 Extended Topology Information**

When CPUID executes with EAX set to 1FH, the processor returns information about extended topology enumeration data. Software must detect the presence of CPUID leaf 1FH by verifying (a) the highest leaf index supported by CPUID is  $\geq 1FH$ , and (b) CPUID.1FH:EBX[15:0] reports a non-zero value. See Table 1-3.

### **INPUT EAX = 20H: Returns Processor History Reset Information**

When CPUID executes with EAX set to 20H, the processor returns information about processor history reset. See Table 1-3.

### **INPUT EAX = 23H: Returns Architectural Performance Monitoring Extended Information**

When CPUID executes with EAX set to 23H, the processor returns architectural performance monitoring extended information. See Table 1-3.

### **INPUT EAX = 24H: Returns Intel AVX10 Converged Vector ISA Information**

When CPUID executes with EAX set to 24H, the processor returns Intel AVX10 converged vector ISA information. See Table 1-3.

## **METHODS FOR RETURNING BRANDING INFORMATION**

Use the following techniques to access branding information:

1. Processor brand string method; this method also returns the processor's maximum operating frequency
2. Processor brand index; this method uses a software supplied brand string table.

These two methods are discussed in the following sections. For methods that are available in early processors, see Section: "Identification of Earlier IA-32 Processors" in Chapter 21 of the Intel® 64 and IA-32 Architectures Software Developer's Manual, Volume 1.

### **The Processor Brand String Method**

Figure 1-4 describes the algorithm used for detection of the brand string. Processor brand identification software should execute this algorithm on all Intel 64 and IA-32 processors.

This method (introduced with Pentium 4 processors) returns an ASCII brand identification string and the maximum operating frequency of the processor to the EAX, EBX, ECX, and EDX registers.



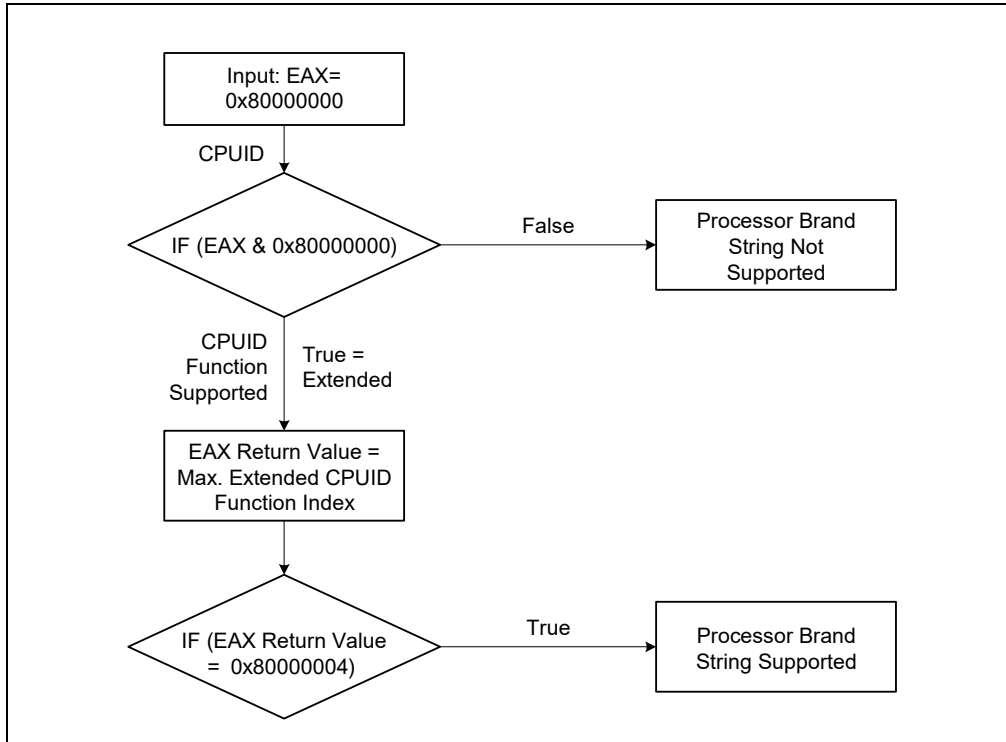

**Figure 1-4. Determination of Support for the Processor Brand String**

**How Brand Strings Work**

To use the brand string method, execute CPUID with EAX input of 8000002H through 80000004H. For each input value, CPUID returns 16 ASCII characters using EAX, EBX, ECX, and EDX. The returned string will be NULL-terminated.

Table 1-8 shows the brand string that is returned by the first processor in the Pentium 4 processor family.

**Table 1-8. Processor Brand String Returned with Pentium 4 Processor**

EAX Input Value	Return Values	ASCII Equivalent
80000002H	EAX = 20202020H EBX = 20202020H ECX = 20202020H EDX = 6E492020H	" " " " " " "nI "
80000003H	EAX = 286C6574H EBX = 50202952H ECX = 69746E65H EDX = 52286D75H	"(let" "P )R" "itne" "R(mu"
80000004H	EAX = 20342029H EBX = 20555043H ECX = 30303531H EDX = 007A484DH	" 4 )" " UPC" "0051" "\0zHM"

### Extracting the Maximum Processor Frequency from Brand Strings

Figure 1-5 provides an algorithm which software can use to extract the maximum processor operating frequency from the processor brand string.

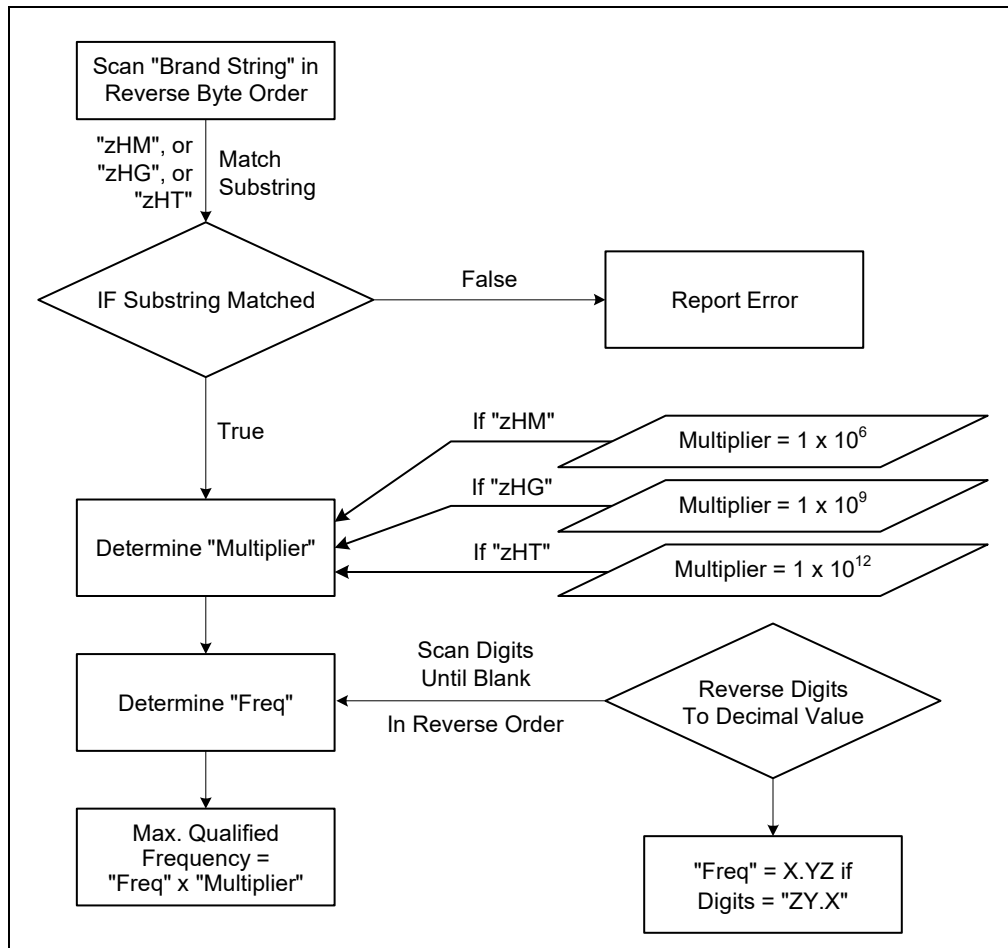

Figure 1-5. Algorithm for Extracting Maximum Processor Frequency

#### NOTE

When a frequency is given in a brand string, it is the maximum qualified frequency of the processor, not the frequency at which the processor is currently running.

#### The Processor Brand Index Method

The brand index method (introduced with Pentium® III Xeon® processors) provides an entry point into a brand identification table that is maintained in memory by system software and is accessible from system- and user-level code. In this table, each brand index is associated with an ASCII brand identification string that identifies the official Intel family and model number of a processor.

When CPUID executes with EAX set to 01H, the processor returns a brand index to the low byte in EBX. Software can then use this index to locate the brand identification string for the processor in the brand identification table. The first entry (brand index 0) in this table is reserved, allowing for backward compatibility with processors that do not support the brand identification feature. Starting with processor signature family ID = 0FH, model = 03H, brand index method is no longer supported. Use brand string method instead.

Table 1-9 shows brand indices that have identification strings associated with them.

**Table 1-9. Mapping of Brand Indices; and Intel 64 and IA-32 Processor Brand Strings**

Brand Index	Brand String
00H	This processor does not support the brand identification feature
01H	Intel(R) Celeron(R) processor <sup>1</sup>
02H	Intel(R) Pentium(R) III processor <sup>1</sup>
03H	Intel(R) Pentium(R) III Xeon(R) processor; If processor signature = 000006B1h, then Intel(R) Celeron(R) processor
04H	Intel(R) Pentium(R) III processor
06H	Mobile Intel(R) Pentium(R) III processor-M
07H	Mobile Intel(R) Celeron(R) processor <sup>1</sup>
08H	Intel(R) Pentium(R) 4 processor
09H	Intel(R) Pentium(R) 4 processor
0AH	Intel(R) Celeron(R) processor <sup>1</sup>
0BH	Intel(R) Xeon(R) processor; If processor signature = 00000F13h, then Intel(R) Xeon(R) processor MP
0CH	Intel(R) Xeon(R) processor MP
0EH	Mobile Intel(R) Pentium(R) 4 processor-M; If processor signature = 00000F13h, then Intel(R) Xeon(R) processor
0FH	Mobile Intel(R) Celeron(R) processor <sup>1</sup>
11H	Mobile Genuine Intel(R) processor
12H	Intel(R) Celeron(R) M processor
13H	Mobile Intel(R) Celeron(R) processor <sup>1</sup>
14H	Intel(R) Celeron(R) processor
15H	Mobile Genuine Intel(R) processor
16H	Intel(R) Pentium(R) M processor
17H	Mobile Intel(R) Celeron(R) processor <sup>1</sup>
18H - 0FFH	RESERVED

**NOTES:**

1.Indicates versions of these processors that were introduced after the Pentium III.

**IA-32 Architecture Compatibility**

CPUID is not supported in early models of the Intel486 processor or in any IA-32 processor earlier than the Intel486 processor.

**Operation**

IA32\_BIOS\_SIGN\_ID MSR := Update with installed microcode revision number;

CASE (EAX) OF

EAX = 0:

EAX := Highest basic function input value understood by CPUID;

EBX := Vendor identification string;

EDX := Vendor identification string;

ECX := Vendor identification string;

BREAK;

EAX = 1H:

EAX[3:0] := Stepping ID;

EAX[7:4] := Model;

EAX[11:8] := Family;  
 EAX[13:12] := Processor type;  
 EAX[15:14] := Reserved;  
 EAX[19:16] := Extended Model;  
 EAX[27:20] := Extended Family;  
 EAX[31:28] := Reserved;  
 EBX[7:0] := Brand Index; (\* Reserved if the value is zero. \*)  
 EBX[15:8] := CLFLUSH Line Size;  
 EBX[16:23] := Reserved; (\* Number of threads enabled = 2 if MT enable fuse set. \*)  
 EBX[24:31] := Initial APIC ID;  
 ECX := Feature flags; (\* See Figure 1-2. \*)  
 EDX := Feature flags; (\* See Figure 1-3. \*)

BREAK;

EAX = 2H:

EAX := Cache and TLB information;  
 EBX := Cache and TLB information;  
 ECX := Cache and TLB information;  
 EDX := Cache and TLB information;

BREAK;

EAX = 3H:

EAX := Reserved;  
 EBX := Reserved;  
 ECX := ProcessorSerialNumber[31:0];  
 (\* Pentium III processors only, otherwise reserved. \*)  
 EDX := ProcessorSerialNumber[63:32];  
 (\* Pentium III processors only, otherwise reserved. \*)

BREAK

EAX = 4H:

EAX := Deterministic Cache Parameters Leaf; (\* See Table 1-3. \*)  
 EBX := Deterministic Cache Parameters Leaf;  
 ECX := Deterministic Cache Parameters Leaf;  
 EDX := Deterministic Cache Parameters Leaf;

BREAK;

EAX = 5H:

EAX := MONITOR/MWAIT Leaf; (\* See Table 1-3. \*)  
 EBX := MONITOR/MWAIT Leaf;  
 ECX := MONITOR/MWAIT Leaf;  
 EDX := MONITOR/MWAIT Leaf;

BREAK;

EAX = 6H:

EAX := Thermal and Power Management Leaf; (\* See Table 1-3. \*)  
 EBX := Thermal and Power Management Leaf;  
 ECX := Thermal and Power Management Leaf;  
 EDX := Thermal and Power Management Leaf;

BREAK;

EAX = 7H:

EAX := Structured Extended Feature Leaf; (\* See Table 1-3. \*)  
 EBX := Structured Extended Feature Leaf;  
 ECX := Structured Extended Feature Leaf;  
 EDX := Structured Extended Feature Leaf;

BREAK;

EAX = 8H:

EAX := Reserved = 0;  
 EBX := Reserved = 0;

ECX := Reserved = 0;  
EDX := Reserved = 0;  
BREAK;  
EAX = 9H:  
EAX := Direct Cache Access Information Leaf; (\* See Table 1-3. \*)  
EBX := Direct Cache Access Information Leaf;  
ECX := Direct Cache Access Information Leaf;  
EDX := Direct Cache Access Information Leaf;  
BREAK;  
EAX = AH:  
EAX := Architectural Performance Monitoring Leaf; (\* See Table 1-3. \*)  
EBX := Architectural Performance Monitoring Leaf;  
ECX := Architectural Performance Monitoring Leaf;  
EDX := Architectural Performance Monitoring Leaf;  
BREAK;  
EAX = BH:  
EAX := Extended Topology Enumeration Leaf; (\* See Table 1-3. \*)  
EBX := Extended Topology Enumeration Leaf;  
ECX := Extended Topology Enumeration Leaf;  
EDX := Extended Topology Enumeration Leaf;  
BREAK;  
EAX = CH:  
EAX := Reserved = 0;  
EBX := Reserved = 0;  
ECX := Reserved = 0;  
EDX := Reserved = 0;  
BREAK;  
EAX = DH:  
EAX := Processor Extended State Enumeration Leaf; (\* See Table 1-3. \*)  
EBX := Processor Extended State Enumeration Leaf;  
ECX := Processor Extended State Enumeration Leaf;  
EDX := Processor Extended State Enumeration Leaf;  
BREAK;  
EAX = EH:  
EAX := Reserved = 0;  
EBX := Reserved = 0;  
ECX := Reserved = 0;  
EDX := Reserved = 0;  
BREAK;  
EAX = FH:  
EAX := Platform Quality of Service Monitoring Enumeration Leaf; (\* See Table 1-3. \*)  
EBX := Platform Quality of Service Monitoring Enumeration Leaf;  
ECX := Platform Quality of Service Monitoring Enumeration Leaf;  
EDX := Platform Quality of Service Monitoring Enumeration Leaf;  
BREAK;  
EAX = 10H:  
EAX := Platform Quality of Service Enforcement Enumeration Leaf; (\* See Table 1-3. \*)  
EBX := Platform Quality of Service Enforcement Enumeration Leaf;  
ECX := Platform Quality of Service Enforcement Enumeration Leaf;  
EDX := Platform Quality of Service Enforcement Enumeration Leaf;  
BREAK;  
EAX = 12H:  
EAX := Intel SGX Enumeration Leaf; (\* See Table 1-3. \*)  
EBX := Intel SGX Enumeration Leaf;

ECX := Intel SGX Enumeration Leaf;  
EDX := Intel SGX Enumeration Leaf;  
BREAK;  
EAX = 14H:  
EAX := Intel Processor Trace Enumeration Leaf; (\* See Table 1-3. \*)  
EBX := Intel Processor Trace Enumeration Leaf;  
ECX := Intel Processor Trace Enumeration Leaf;  
EDX := Intel Processor Trace Enumeration Leaf;  
BREAK;  
EAX = 15H:  
EAX := Time Stamp Counter and Core Crystal Clock Information Leaf; (\* See Table 1-3. \*)  
EBX := Time Stamp Counter and Core Crystal Clock Information Leaf;  
ECX := Time Stamp Counter and Core Crystal Clock Information Leaf;  
EDX := Time Stamp Counter and Core Crystal Clock Information Leaf;  
BREAK;  
EAX = 16H:  
EAX := Processor Frequency Information Enumeration Leaf; (\* See Table 1-3. \*)  
EBX := Processor Frequency Information Enumeration Leaf;  
ECX := Processor Frequency Information Enumeration Leaf;  
EDX := Processor Frequency Information Enumeration Leaf;  
BREAK;  
EAX = 17H:  
EAX := System-On-Chip Vendor Attribute Enumeration Leaf; (\* See Table 1-3. \*)  
EBX := System-On-Chip Vendor Attribute Enumeration Leaf;  
ECX := System-On-Chip Vendor Attribute Enumeration Leaf;  
EDX := System-On-Chip Vendor Attribute Enumeration Leaf;  
BREAK;  
EAX = 18H:  
EAX := Deterministic Address Translation Parameters Enumeration Leaf; (\* See Table 1-3. \*)  
EBX := Deterministic Address Translation Parameters Enumeration Leaf;  
ECX := Deterministic Address Translation Parameters Enumeration Leaf;  
EDX := Deterministic Address Translation Parameters Enumeration Leaf;  
BREAK;  
EAX = 19H:  
EAX := Key Locker Enumeration Leaf; (\* See Table 1-3. \*)  
EBX := Key Locker Enumeration Leaf;  
ECX := Key Locker Enumeration Leaf;  
EDX := Key Locker Enumeration Leaf;  
BREAK;  
EAX = 1AH:  
EAX := Hybrid Information Enumeration Leaf; (\* See Table 1-3. \*)  
EBX := Hybrid Information Enumeration Leaf;  
ECX := Hybrid Information Enumeration Leaf;  
EDX := Hybrid Information Enumeration Leaf;  
BREAK;  
EAX = 1BH:  
EAX := PCONFIG Information Enumeration Leaf; (\* See Table 1-3. \*)  
EBX := PCONFIG Information Enumeration Leaf;  
ECX := PCONFIG Information Enumeration Leaf;  
EDX := PCONFIG Information Enumeration Leaf;  
BREAK;  
EAX = 1CH:  
EAX := Last Branch Record Information Enumeration Leaf; (\* See Table 1-3. \*)  
EBX := Last Branch Record Information Enumeration Leaf;

ECX := Last Branch Record Information Enumeration Leaf;  
 EDX := Last Branch Record Information Enumeration Leaf;

BREAK;

EAX = 1DH:

EAX := Tile Information Enumeration Leaf; (\* See Table 1-3. \*)  
 EBX := Tile Information Enumeration Leaf;  
 ECX := Tile Information Enumeration Leaf;  
 EDX := Tile Information Enumeration Leaf;

BREAK;

EAX = 1EH:

EAX := TMUL Information Enumeration Leaf; (\* See Table 1-3. \*)  
 EBX := TMUL Information Enumeration Leaf;  
 ECX := TMUL Information Enumeration Leaf;  
 EDX := TMUL Information Enumeration Leaf;

BREAK;

EAX = 1FH:

EAX := V2 Extended Topology Enumeration Leaf; (\* See Table 1-3. \*)  
 EBX := V2 Extended Topology Enumeration Leaf;  
 ECX := V2 Extended Topology Enumeration Leaf;  
 EDX := V2 Extended Topology Enumeration Leaf;

BREAK;

EAX = 20H:

EAX := Processor History Reset Enumeration Leaf; (\* See Table 1-3. \*)  
 EBX := Processor History Reset Enumeration Leaf;  
 ECX := Processor History Reset Enumeration Leaf;  
 EDX := Processor History Reset Enumeration Leaf;

BREAK;

EAX = 23H:

EAX := Architectural Performance Monitoring Extended Leaf; (\* See Table 1-3. \*)  
 EBX := Architectural Performance Monitoring Extended Leaf;  
 ECX := Architectural Performance Monitoring Extended Leaf;  
 EDX := Architectural Performance Monitoring Extended Leaf;

BREAK;

EAX = 24H:

EAX := Intel AVX10 Converged Vector ISA Leaf; (\* See Table 1-3. \*)  
 EBX := Intel AVX10 Converged Vector ISA Leaf;  
 ECX := Intel AVX10 Converged Vector ISA Leaf;  
 EDX := Intel AVX10 Converged Vector ISA Leaf;

BREAK;

EAX = 27H:

EAX := Asymmetric Platform Quality of Service Monitoring Enumeration Leaf; (\* See Table 1-3. \*)  
 EBX := Asymmetric Platform Quality of Service Monitoring Enumeration Leaf;  
 ECX := Asymmetric Platform Quality of Service Monitoring Enumeration Leaf;  
 EDX := Asymmetric Platform Quality of Service Monitoring Enumeration Leaf;

BREAK;

EAX = 28H:

EAX := Asymmetric Platform Quality of Service Enforcement Enumeration Leaf; (\* See Table 1-3. \*)  
 EBX := Asymmetric Platform Quality of Service Enforcement Enumeration Leaf;  
 ECX := Asymmetric Platform Quality of Service Enforcement Enumeration Leaf;  
 EDX := Asymmetric Platform Quality of Service Enforcement Enumeration Leaf;

BREAK;

EAX = 80000000H:

EAX := Highest extended function input value understood by CPUID;  
 EBX := Reserved;

```

    ECX := Reserved;
    EDX := Reserved;
BREAK;
EAX = 80000001H:
    EAX := Reserved;
    EBX := Reserved;
    ECX := Extended Feature Bits (* See Table 1-3.*);
    EDX := Extended Feature Bits (* See Table 1-3.*);
BREAK;
EAX = 80000002H:
    EAX := Processor Brand String;
    EBX := Processor Brand String, continued;
    ECX := Processor Brand String, continued;
    EDX := Processor Brand String, continued;
BREAK;
EAX = 80000003H:
    EAX := Processor Brand String, continued;
    EBX := Processor Brand String, continued;
    ECX := Processor Brand String, continued;
    EDX := Processor Brand String, continued;
BREAK;
EAX = 80000004H:
    EAX := Processor Brand String, continued;
    EBX := Processor Brand String, continued;
    ECX := Processor Brand String, continued;
    EDX := Processor Brand String, continued;
BREAK;
EAX = 80000005H:
    EAX := Reserved = 0;
    EBX := Reserved = 0;
    ECX := Reserved = 0;
    EDX := Reserved = 0;
BREAK;
EAX = 80000006H:
    EAX := Reserved = 0;
    EBX := Reserved = 0;
    ECX := Cache information;
    EDX := Reserved = 0;
BREAK;
EAX = 80000007H:
    EAX := Reserved = 0;
    EBX := Reserved = 0;
    ECX := Reserved = 0;
    EDX := Reserved = Miscellaneous feature flags;
BREAK;
EAX = 80000008H:
    EAX := Address size information;
    EBX := Miscellaneous feature flags;
    ECX := Reserved = 0;
    EDX := Reserved = 0;
BREAK;
DEFAULT: (* EAX = Value outside of recognized range for CPUID. *)
    (* If the highest basic information leaf data depend on ECX input value, ECX is honored. *)
    EAX := Reserved; (* Information returned for highest basic information leaf. *)

```



EBX := Reserved; (\* Information returned for highest basic information leaf. \*)  
 ECX := Reserved; (\* Information returned for highest basic information leaf. \*)  
 EDX := Reserved; (\* Information returned for highest basic information leaf. \*)

BREAK;  
 ESAC;

**Flags Affected**

None.

**Exceptions (All Operating Modes)**

#UD If the LOCK prefix is used.

In earlier IA-32 processors that do not support the CPUID instruction, execution of the instruction results in an invalid opcode (#UD) exception being generated.§

**1.5 COMPRESSED DISPLACEMENT (DISP8\*N) SUPPORT IN EVEX**

For memory addressing using disp8 form, EVEX-encoded instructions always use a compressed displacement scheme by multiplying disp8 in conjunction with a scaling factor N that is determined based on the vector length, the value of EVEX.b bit (embedded broadcast) and the input element size of the instruction. In general, the factor N corresponds to the number of bytes characterizing the internal memory operation of the input operand (e.g., 64 when the accessing a full 512-bit memory vector). The scale factor N is listed in Table 1-10 and Table 1-11 below, where EVEX encoded instructions are classified using the **tupletype** attribute. The scale factor N of each tupletype is listed based on the vector length (VL) and other factors affecting it.

Table 1-10 covers EVEX-encoded instructions which has a load semantic in conjunction with additional computational or data element movement operation, operating either on the full vector or half vector (due to conversion of numerical precision from a wider format to narrower format). EVEX.b is supported for such instructions for data element sizes which are either dword or qword.

EVEX-encoded instruction that are pure load/store, and "Load+op" instruction semantic that operate on data element size less than dword do not support broadcasting using EVEX.b. These are listed in Table 1-11. Table 1-11 also includes many broadcast instructions which perform broadcast using a subset of data elements without using EVEX.b. These instructions and a few data element size conversion instruction are covered in Table 1-11. Instruction classified in Table 1-11 do not use EVEX.b and EVEX.b must be 0, otherwise #UD will occur.

The tupletype will be referenced in the instruction operand encoding table in the reference page of each instruction, providing the cross reference for the scaling factor N to encoding memory addressing operand.

Note that the disp8\*N rules still apply when using 16b addressing.

**Table 1-10. Compressed Displacement (DISP8\*N) Affected by Embedded Broadcast**

TupleType	EVEX.b	InputSize	EVEX.W	Broadcast	N (VL=128)	N (VL=256)	N (VL= 512)	Comment
Full	0	32bit	0	none	16	32	64	Load+Op (Full Vector Dword/Qword)
	1	32bit	0	{1tox}	4	4	4	
	0	64bit	1	none	16	32	64	
	1	64bit	1	{1tox}	8	8	8	
Half	0	32bit	0	none	8	16	32	Load+Op (Half Vector)
	1	32bit	0	{1tox}	4	4	4	

**Table 1-11. EVEX DISP8\*N for Instructions Not Affected by Embedded Broadcast**

Tuple Type	InputSize	EVEX.W	N (VL= 128)	N (VL= 256)	N (VL= 512)	Comment
Full Mem	N/A	N/A	16	32	64	Load/store or subDword full vector

**Table 1-11. EVEX DISP8\*N for Instructions Not Affected by Embedded Broadcast (Continued)**

Tuple Type	InputSize	EVEX.W	N (VL= 128)	N (VL= 256)	N (VL= 512)	Comment
Tuple1 Scalar	8bit	N/A	1	1	1	1 Tuple
	16bit	N/A	2	2	2	
	32bit	0	4	4	4	
	64bit	1	8	8	8	
Tuple1 Fixed	32bit	N/A	4	4	4	1 Tuple, memsize not affected by EVEX.W
	64bit	N/A	8	8	8	
Tuple1_4X	32bit	0	16 <sup>1</sup>	N/A	16	4FMA(PS)
Tuple2	32bit	0	8	8	8	Broadcast (2 elements)
	64bit	1	NA	16	16	
Tuple4	32bit	0	NA	16	16	Broadcast (4 elements)
	64bit	1	NA	NA	32	
Tuple8	32bit	0	NA	NA	32	Broadcast (8 elements)
Half Mem	N/A	N/A	8	16	32	SubQword Conversion
Quarter Mem	N/A	N/A	4	8	16	SubDword Conversion
Eighth Mem	N/A	N/A	2	4	8	SubWord Conversion
Mem128	N/A	N/A	16	16	16	Shift count from memory
MOVDDUP	N/A	N/A	8	32	64	VMOVDDUP

**NOTES:**

1. Scalar.

## 1.6 BFLOAT16 FLOATING-POINT FORMAT

Intel® Deep Learning Boost (Intel® DL Boost) uses bfloat16 format (BF16). Figure 1-6 illustrates BF16 versus FP16 and FP32.

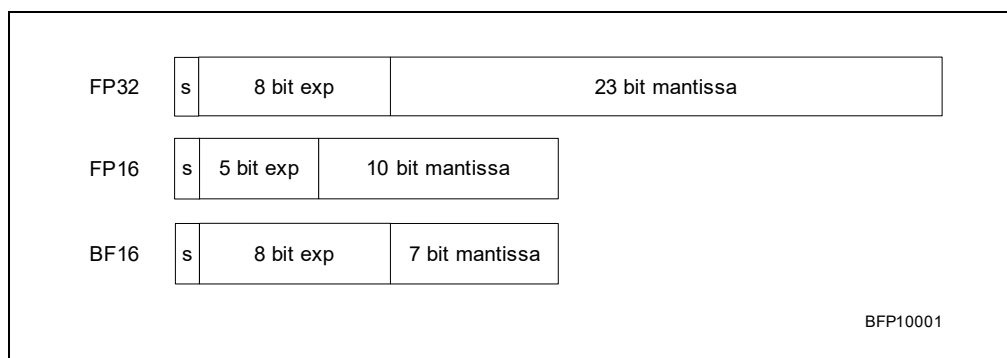

**Figure 1-6. Comparison of BF16 to FP16 and FP32**

BF16 has several advantages over FP16:

- It can be seen as a short version of FP32, skipping the least significant 16 bits of mantissa.
- There is no need to support denormals; FP32, and therefore also BF16, offer more than enough range for deep learning training tasks.

- FP32 accumulation after the multiply is essential to achieve sufficient numerical behavior on an application level.
- Hardware exception handling is not needed as this is a performance optimization; industry is designing algorithms around checking inf/NaN.

## 1.7 FP8 FORMAT

FP8 are new data types of floating-point numbers consisting of 8 bits. They are aimed to speedup both Training and Inference AI workloads.

### 1.7.1 Numeric Definition

Intel architecture supports two different FP8 formats. The first supported format is BF8, Brain Float8 (E5M2), which has one sign bit, five exponent bits, and two mantissa bits. The second supported format is HF8, Hybrid Float8 (E4M3), which has one sign bit, four exponent bits, and three mantissa bits. Due to this new data type's very small range and precision, both formats are needed to converge and reach the required accuracy across a wide range of AI topologies. Table 1-12 below describes the numerics of each format. While BF8 follows standard floating point representations, the HF8 format has a non-standard definition to increase its range, including the same representation for Infinity and NaN.

**Table 1-12. FP8 Formats Numeric Definitions**

Number	BF8 (E5M2)	HF8 (E4M3)
Exponent Bias	15	7
Maximum Normal	S.11110.11 = 57344.0 ( $1.75 * 2^{15}$ )	S.1111.110 = 448.0 ( $1.75 * 2^8$ )
Minimum Normal	S.00001.00 = 6.10e-05 ( $2^{-14}$ )	S.0001.000 = 1.56e-02 ( $2^{-6}$ )
Maximum Denormal	S.00000.11 = 4.57e-05 ( $0.75 * 2^{-14}$ )	S.0000.111 = 1.36e-02 ( $0.875 * 2^{-6}$ )
Minimum Denormal	S.00000.01 = 1.52e-05 ( $0.25 * 2^{-14}$ )	S.0000.001 = 1.95e-03 ( $0.125 * 2^{-6}$ )
NaNs	S.11111.[01, 10, 11]	S.1111.111
Infinity	S.11111.00	N/A

### 1.7.2 Floating-Point Rounding, Denormal Handling, NaN/Inf/Overflow Handling, and FP Exceptions

Intel architecture supports AMX compute instructions, AVX dot product instructions, and AVX convert instructions. The convert instructions have two versions, \*NE\* and \*BIAS\*, indicating the rounding modes.

- Floating-point rounding: Excluding the \*BIAS\* convert instructions, all instructions use RNE ("round to nearest even") rounding mode. The \*BIAS\* convert instructions use RNE in case the input is denormal and truncate (i.e., chop or round towards zero) for normal input.
- Denormal Handling: All instructions function as if floating-point exceptions are masked. For any type of input, instructions behave as if MXCSR.DAZ is not set. For FP8 output type, instructions behave as if MXCSR.FTZ is not set. For any other type of output, instructions behave as if MXCSR.FTZ is set.
- Special numbers: Nan/inf/overflow handling: Excluding convert instructions, all instructions behave in their regular way. Infinity is bypassed, NaN is bypassed as QNaN, and overflow returns infinity. The convert instructions have saturation and non-saturation versions. Table 1-13 describes the convert instruction behavior in these cases.
- Floating-point exceptions:
  - Instructions do not consult MXCSR.
  - Instructions do not raise exceptions.



- Excluding convert instructions, instructions do not update MXCSR.
- All convert instructions update MXCSR.

**Table 1-13. FP Numerical Handling of Converts**

Version	Scenario	BF8 (E5M2)	HF8 (E4M3)
Regular	NaN at input	S.11111.[10, 11]	S.1111.111
	+/- infinity at input	S.11111.00	S.1111.111
	Overflow due to conversion /rounding	S.11111.00	S.1111.111
Saturated	NaN at input	S.11111.[10, 11]	S.1111.111
	+/- infinity at input	S.11111.00	S.1111.111
	Overflow due to conversion /rounding	S.11110.11	S.1111.110

Instructions described in this document follow the general documentation convention established in the Intel® 64 and IA-32 Architectures Software Developer's Manual Volume 2A. Additionally, some instructions use notation conventions as described below.

In the instruction encoding, the MODRM byte is represented several ways depending on the role it plays. The MODRM byte has 3 fields: 2-bit MODRM.MOD field, a 3-bit MODRM.REG field and a 3-bit MODRM.RM field. When all bits of the MODRM byte have fixed values for an instruction, the 2-hex nibble value of that byte is presented after the opcode in the encoding boxes on the instruction description pages. When only some fields of the MODRM byte must contain fixed values, those values are specified as follows:

- If only the MODRM.MOD must be 0b11, and MODRM.REG and MODRM.RM fields are unrestricted, this is denoted as **11:rrr:bbb**. The **rrr** correspond to the 3-bits of the MODRM.REG field and the **bbb** correspond to the 3-bits of the MODRM.RM field.
- If the MODRM.MOD field is constrained to be a value other than 0b11, i.e., it must be one of 0b00, 0b01, or 0b10, then we use the notation !(11).
- If for example only the MODRM.REG field had a specific required value, e.g., 0b101, that would be denoted as mm:101:bbb.

#### NOTE

Historically the Intel® 64 and IA-32 Architectures Software Developer's Manual only specified the MODRM.REG field restrictions with the notation /0 ... /7 and did not specify restrictions on the MODRM.MOD and MODRM.RM fields in the encoding boxes.

## 2.1 INSTRUCTION SET REFERENCE

## AADD—Atomically Add

Opcode/ Instruction	Op/ En	64/32 bit Mode Support	CPUID Feature Flag	Description
NP 0F38 FC !{(11):rrr:bbb AADD <i>my, ry</i>	A	V/V	RAO-INT	Atomically add <i>my</i> with <i>ry</i> and store the result in <i>my</i> .

### Instruction Operand Encoding

Op/En	Operand 1	Operand 2	Operand 3	Operand 4
A	ModRM:r/m ( <i>r, w</i> )	ModRM:reg ( <i>r</i> )	N/A	N/A

### Description

This instruction is a remote atomic integer operation. This instruction atomically adds the destination operand (first operand) and the source operand (second operand), and then stores the result in the destination operand.

The destination operand is a memory location and the source operand is a register. In 64-bit mode, the instruction's default operation size is 32 bits. Using a REX prefix in the form of REX.R permits access to additional registers (R8-R15). Using a REX prefix in the form of REX.W promotes operation to 64 bits. The destination operand must be naturally aligned with respect to the data size, at a 4-byte boundary, or an 8-byte boundary if used with a REX.W prefix in 64-bit mode.

This instruction requires that the destination operand has a write-back (WB) memory type and it is implemented using the weakly-ordered memory consistency model of write combining (WC) memory type. Before the operation, the cache line is written-back (if modified) and invalidated from the processor cache. When the operation completes, the processor may optimize the cacheability of the destination address by writing the result only to specific levels of the cache hierarchy. Because this instructions uses a weakly-ordered memory consistency model, a fencing operation implemented with LFENCE, SFENCE, or MFENCE instruction should be used in conjunction with AADD if a stronger ordering is required. However, note that AADD is not ordered with respect to a younger LFENCE. Any attempt to execute the AADD instruction inside an Intel TSX transaction will result in a transaction abort.

### Operation

**AADD *dest, src***

*dest* := *dest* + *src*;

### Flags Affected

None.

### Protected Mode Exceptions

- #GP(0) For an illegal memory operand effective address in the CS, DS, ES, FS or GS segments.  
If the memory address is not naturally aligned to the operand size.
- #SS(0) If the memory address memory type is not write-back (WB).
- #SS(0) For an illegal address in the SS segment.
- #PF(fault-code) If a page fault occurs.
- #UD If the LOCK prefix is used.  
If CPUID.(EAX=07H, ECX=01H):EAX.RAO-INT[bit 3] = 0.

### Real-Address Mode Exceptions

#GP	If any part of the operand lies outside the effective address space from 0 to FFFFH. If the memory address is not naturally aligned to the operand size. If the memory address memory type is not write-back (WB).
#SS	For an illegal address in the SS segment.
#UD	If the LOCK prefix is used. If CPUID.(EAX=07H, ECX=01H):EAX.RAO-INT[bit 3] = 0.

### Virtual-8086 Mode Exceptions

Same exceptions as in protected mode.

### Compatibility Mode Exceptions

Same exceptions as in protected mode.

### 64-Bit Mode Exceptions

#GP(0)	If the memory address is in a non-canonical form. If the memory address is not naturally aligned to the operand size. If the memory address memory type is not write-back (WB).
#SS(0)	If a memory address referencing the SS segment is in a non-canonical form.
#PF(fault-code)	If a page fault occurs.
#UD	If the LOCK prefix is used. If CPUID.(EAX=07H, ECX=01H):EAX.RAO-INT[bit 3] = 0.

## AAND—Atomically AND

Opcode/ Instruction	Op/ En	64/32 bit Mode Support	CPUID Feature Flag	Description
66 0F38 FC !{11};rrr:bbb AAND <i>my, ry</i>	A	V/V	RAO-INT	Atomically AND <i>my</i> with <i>ry</i> and store the result in <i>my</i> .

### Instruction Operand Encoding

Op/En	Operand 1	Operand 2	Operand 3	Operand 4
A	ModRM:r/m ( <i>r, w</i> )	ModRM:reg ( <i>r</i> )	N/A	N/A

### Description

This instruction is a remote atomic integer operation. This instruction atomically performs a bitwise AND operation of the destination operand (first operand) and the source operand (second operand), and then stores the result in the destination operand.

The destination operand is a memory location and the source operand is a register. In 64-bit mode, the instruction's default operation size is 32 bits. Using a REX prefix in the form of REX.R permits access to additional registers (R8-R15). Using a REX prefix in the form of REX.W promotes operation to 64 bits. The destination operand must be naturally aligned with respect to the data size, at a 4-byte boundary, or an 8-byte boundary if used with a REX.W prefix in 64-bit mode.

This instruction requires that the destination operand has a write-back (WB) memory type and it is implemented using the weakly-ordered memory consistency model of write combining (WC) memory type. Before the operation, the cache line is written-back (if modified) and invalidated from the processor cache. When the operation completes, the processor may optimize the cacheability of the destination address by writing the result only to specific levels of the cache hierarchy. Because this instructions uses a weakly-ordered memory consistency model, a fencing operation implemented with LFENCE, SFENCE, or MFENCE instruction should be used in conjunction with AAND if a stronger ordering is required. However, note that AAND is not ordered with respect to a younger LFENCE. Any attempt to execute the AAND instruction inside an Intel TSX transaction will result in a transaction abort.

### Operation

**AAND dest, src**

dest := dest AND src;

### Flags Affected

None.

### Protected Mode Exceptions

#GP(0)	For an illegal memory operand effective address in the CS, DS, ES, FS or GS segments. If the memory address is not naturally aligned to the operand size.
#SS(0)	If the memory address memory type is not write-back (WB).
#PF(fault-code)	For an illegal address in the SS segment.
#UD	If a page fault occurs.
	If the LOCK prefix is used.
	If CPUID.(EAX=07H, ECX=01H):EAX.RAO-INT[bit 3] = 0.



### Real-Address Mode Exceptions

#GP	If any part of the operand lies outside the effective address space from 0 to FFFFH. If the memory address is not naturally aligned to the operand size. If the memory address memory type is not write-back (WB).
#SS	For an illegal address in the SS segment.
#UD	If the LOCK prefix is used. If CPUID.(EAX=07H, ECX=01H):EAX.RAO-INT[bit 3] = 0.

### Virtual-8086 Mode Exceptions

Same exceptions as in protected mode.

### Compatibility Mode Exceptions

Same exceptions as in protected mode.

### 64-Bit Mode Exceptions

#GP(0)	If the memory address is in a non-canonical form. If the memory address is not naturally aligned to the operand size. If the memory address memory type is not write-back (WB).
#SS(0)	If a memory address referencing the SS segment is in a non-canonical form.
#PF(fault-code)	If a page fault occurs.
#UD	If the LOCK prefix is used. If CPUID.(EAX=07H, ECX=01H):EAX.RAO-INT[bit 3] = 0.

## AOR—Atomically OR

Opcode/ Instruction	Op/ En	64/32 bit Mode Support	CPUID Feature Flag	Description
F2 0F38 FC !{(11);rrr:bbb AOR <i>my, ry</i>	A	V/V	RAO-INT	Atomically OR <i>my</i> with <i>ry</i> and store the result in <i>my</i> .

### Instruction Operand Encoding

Op/En	Operand 1	Operand 2	Operand 3	Operand 4
A	ModRM:r/m ( <i>r, w</i> )	ModRM:reg ( <i>r</i> )	N/A	N/A

### Description

This instruction is a remote atomic integer operation. This instruction atomically performs a bitwise OR operation of the destination operand (first operand) and the source operand (second operand), and then stores the result in the destination operand.

The destination operand is a memory location and the source operand is a register. In 64-bit mode, the instruction's default operation size is 32 bits. Using a REX prefix in the form of REX.R permits access to additional registers (R8-R15). Using a REX prefix in the form of REX.W promotes operation to 64 bits. The destination operand must be naturally aligned with respect to the data size, at a 4-byte boundary, or an 8-byte boundary if used with a REX.W prefix in 64-bit mode.

This instruction requires that the destination operand has a write-back (WB) memory type and it is implemented using the weakly-ordered memory consistency model of write combining (WC) memory type. Before the operation, the cache line is written-back (if modified) and invalidated from the processor cache. When the operation completes, the processor may optimize the cacheability of the destination address by writing the result only to specific levels of the cache hierarchy. Because this instructions uses a weakly-ordered memory consistency model, a fencing operation implemented with LFENCE, SFENCE, or MFENCE instruction should be used in conjunction with AOR if a stronger ordering is required. However, note that AOR is not ordered with respect to a younger LFENCE.

Any attempt to execute the AOR instruction inside an Intel TSX transaction will result in a transaction abort.

### Operation

#### AOR *dest, src*

*dest* := *dest* OR *src*;

### Flags Affected

None.

### Protected Mode Exceptions

#GP(0)	For an illegal memory operand effective address in the CS, DS, ES, FS or GS segments. If the memory address is not naturally aligned to the operand size.
#SS(0)	If the memory address memory type is not write-back (WB).
#SS(0)	For an illegal address in the SS segment.
#PF(fault-code)	If a page fault occurs.
#UD	If the LOCK prefix is used. If CPUID.(EAX=07H, ECX=01H):EAX.RAO-INT[bit 3] = 0.

### Real-Address Mode Exceptions

#GP	If any part of the operand lies outside the effective address space from 0 to FFFFH. If the memory address is not naturally aligned to the operand size. If the memory address memory type is not write-back (WB).
#SS	For an illegal address in the SS segment.
#UD	If the LOCK prefix is used. If CPUID.(EAX=07H, ECX=01H):EAX.RAO-INT[bit 3] = 0.

### Virtual-8086 Mode Exceptions

Same exceptions as in protected mode.

### Compatibility Mode Exceptions

Same exceptions as in protected mode.

### 64-Bit Mode Exceptions

#GP(0)	If the memory address is in a non-canonical form. If the memory address is not naturally aligned to the operand size. If the memory address memory type is not write-back (WB).
#SS(0)	If a memory address referencing the SS segment is in a non-canonical form.
#PF(fault-code)	If a page fault occurs.
#UD	If the LOCK prefix is used. If CPUID.(EAX=07H, ECX=01H):EAX.RAO-INT[bit 3] = 0.

## AXOR—Atomically XOR

Opcode/ Instruction	Op/ En	64/32 bit Mode Support	CPUID Feature Flag	Description
F3 0F38 FC !{(11);rrr:bbb AXOR <i>my, ry</i>	A	V/V	RAO-INT	Atomically XOR <i>my</i> with <i>ry</i> and store the result in <i>my</i> .

### Instruction Operand Encoding

Op/En	Operand 1	Operand 2	Operand 3	Operand 4
A	ModRM:r/m ( <i>r, w</i> )	ModRM:reg ( <i>r</i> )	N/A	N/A

### Description

This instruction is a remote atomic integer operation. This instruction atomically performs a bitwise XOR operation of the destination operand (first operand) and the source operand (second operand), and then stores the result in the destination operand.

The destination operand is a memory location and the source operand is a register. In 64-bit mode, the instruction's default operation size is 32 bits. Using a REX prefix in the form of REX.R permits access to additional registers (R8-R15). Using a REX prefix in the form of REX.W promotes operation to 64 bits. The destination operand must be naturally aligned with respect to the data size, at a 4-byte boundary, or an 8-byte boundary if used with a REX.W prefix in 64-bit mode.

This instruction requires that the destination operand has a write-back (WB) memory type and it is implemented using the weakly-ordered memory consistency model of write combining (WC) memory type. Before the operation, the cache line is written-back (if modified) and invalidated from the processor cache. When the operation completes, the processor may optimize the cacheability of the destination address by writing the result only to specific levels of the cache hierarchy. Because this instructions uses a weakly-ordered memory consistency model, a fencing operation implemented with LFENCE, SFENCE, or MFENCE instruction should be used in conjunction with AXOR if a stronger ordering is required. However, note that AXOR is not ordered with respect to a younger LFENCE. Any attempt to execute the AXOR instruction inside an Intel TSX transaction will result in a transaction abort.

### Operation

**AXOR *dest, src***

*dest* := *dest* XOR *src*;

### Flags Affected

None.

### Protected Mode Exceptions

#GP(0)	For an illegal memory operand effective address in the CS, DS, ES, FS or GS segments. If the memory address is not naturally aligned to the operand size.
#SS(0)	If the memory address memory type is not write-back (WB).
#PF(fault-code)	For an illegal address in the SS segment.
#UD	If a page fault occurs.
	If the LOCK prefix is used.
	If CPUID.(EAX=07H, ECX=01H):EAX.RAO-INT[bit 3] = 0.

### Real-Address Mode Exceptions

#GP	If any part of the operand lies outside the effective address space from 0 to FFFFH. If the memory address is not naturally aligned to the operand size. If the memory address memory type is not write-back (WB).
#SS	For an illegal address in the SS segment.
#UD	If the LOCK prefix is used. If CPUID.(EAX=07H, ECX=01H):EAX.RAO-INT[bit 3] = 0.

### Virtual-8086 Mode Exceptions

Same exceptions as in protected mode.

### Compatibility Mode Exceptions

Same exceptions as in protected mode.

### 64-Bit Mode Exceptions

#GP(0)	If the memory address is in a non-canonical form. If the memory address is not naturally aligned to the operand size. If the memory address memory type is not write-back (WB).
#SS(0)	If a memory address referencing the SS segment is in a non-canonical form.
#PF(fault-code)	If a page fault occurs.
#UD	If the LOCK prefix is used. If CPUID.(EAX=07H, ECX=01H):EAX.RAO-INT[bit 3] = 0.

## MOVRS—Move Read-Shared Value

Opcode / Instruction	Op/En	64/32 bit Mode Support	CPUID Feature Flag	Description
NOREP 0F38 8B !{11};rrr:bbb MOVRS rv, mv	A	V/N.E.	MOVRS	Move a read-shared word, doubleword, or quadword from mv to rv.
NOREP 0F38 8A !{11};rrr:bbb MOVRS r8, m8	A	V/N.E.	MOVRS	Move a read-shared byte from m8 to r8.
EVEX.128.F2.MAP5.W0 6F !{11};rrr:bbb VMOVRSB xmm1{k1}{z}, m128	B	V/N.E.	MOVRS AND AVX10.2	Move read-shared bytes from m128 to xmm1 subject to writemask k1.
EVEX.256.F2.MAP5.W0 6F !{11};rrr:bbb VMOVRSB ymm1{k1}{z}, m256	B	V/N.E.	MOVRS AND AVX10.2	Move read-shared bytes from m256 to ymm1 subject to writemask k1.
EVEX.512.F2.MAP5.W0 6F !{11};rrr:bbb VMOVRSB zmm1{k1}{z}, m512	B	V/N.E.	MOVRS AND AVX10.2	Move read-shared bytes from m512 to zmm1 subject to writemask k1.
EVEX.128.F3.MAP5.W0 6F !{11};rrr:bbb VMOVRSB xmm1{k1}{z}, m128	B	V/N.E.	MOVRS AND AVX10.2	Move read-shared doublewords from m128 to xmm1 subject to writemask k1.
EVEX.256.F3.MAP5.W0 6F !{11};rrr:bbb VMOVRSB ymm1{k1}{z}, m256	B	V/N.E.	MOVRS AND AVX10.2	Move read-shared doublewords from m256 to ymm1 subject to writemask k1.
EVEX.512.F3.MAP5.W0 6F !{11};rrr:bbb VMOVRSB zmm1{k1}{z}, m512	B	V/N.E.	MOVRS AND AVX10.2	Move read-shared doublewords from m512 to zmm1 subject to writemask k1.
EVEX.128.F3.MAP5.W1 6F !{11};rrr:bbb VMOVRSQ xmm1{k1}{z}, m128	B	V/N.E.	MOVRS AND AVX10.2	Move read-shared quadwords from m128 to xmm1 subject to writemask k1.
EVEX.256.F3.MAP5.W1 6F !{11};rrr:bbb VMOVRSQ ymm1{k1}{z}, m256	B	V/N.E.	MOVRS AND AVX10.2	Move read-shared quadwords from m256 to ymm1 subject to writemask k1.
EVEX.512.F3.MAP5.W1 6F !{11};rrr:bbb VMOVRSQ zmm1{k1}{z}, m512	B	V/N.E.	MOVRS AND AVX10.2	Move read-shared quadwords from m512 to zmm1 subject to writemask k1.
EVEX.128.F2.MAP5.W1 6F !{11};rrr:bbb VMOVRSW xmm1{k1}{z}, m128	B	V/N.E.	MOVRS AND AVX10.2	Move read-shared words from m128 to xmm1 subject to writemask k1.
EVEX.256.F2.MAP5.W1 6F !{11};rrr:bbb VMOVRSW ymm1{k1}{z}, m256	B	V/N.E.	MOVRS AND AVX10.2	Move read-shared words from m256 to ymm1 subject to writemask k1.
EVEX.512.F2.MAP5.W1 6F !{11};rrr:bbb VMOVRSW zmm1{k1}{z}, m512	B	V/N.E.	MOVRS AND AVX10.2	Move read-shared words from m512 to zmm1 subject to writemask k1.

## Instruction Operand Encoding

Op/En	Tuple Type	Operand 1	Operand 2	Operand 3	Operand 4
A	N/A	ModRM:reg (w)	ModRM:r/m (r)	N/A	N/A
B	FULLMEM	ModRM:reg (w)	ModRM:r/m (r)	N/A	N/A

## Description

Moves data from the source operand (second operand), a memory operand, to the destination operand (first operand), a register. If the destination is a general-purpose register, then both operands are the same size, which can be a byte, a word, a doubleword, or a quadword. If the destination is an XMM, YMM, or ZMM register, then the instruction reads data from a 128-bit, 256-bit, or 512-bit memory location; the data may be 16, 32, or 64 bytes; 8, 16, or 32 words; 4, 8, or 16 doublewords; or 2, 4, or 8 quadwords. Additionally, this instruction indicates the source memory location is likely to become read-shared by multiple processors, i.e., read in the future by at least one other processor before it is written, assuming it is ever written in the future. Implementations may optimize

the behavior of the caches, especially shared caches, for this data for future reads by multiple processors. A future write to this data before it becomes read-shared will behave as usual, but its performance may be less optimal than if the current read were done via a load without a read-shared hint.

## Operation

### MOVRS DEST, SRC

DEST := SRC

### VMOVRSB DEST, SRC (EVEX Encoded Version)

(KL, VL) = (16, 128), (32, 256), (64, 512)

```

FOR j := 0 TO KL-1
  i := j * 8
  IF k1[j] OR *no writemask*
    THEN DEST[i+7:i] := SRC[i+7:i]
    ELSE
      IF *merging-masking* ; merging-masking
        THEN *DEST[i+7:i] remains unchanged*
        ELSE DEST[i+7:i] := 0 ; zeroing-masking
      FI;
    FI;
ENDFOR
DEST[MAXVL-1:VL] := 0

```

### VMOVRSW DEST, SRC (EVEX Encoded Version)

(KL, VL) = (8, 128), (16, 256), (32, 512)

```

FOR j := 0 TO KL-1
  i := j * 16
  IF k1[j] OR *no writemask*
    THEN DEST[i+15:i] := SRC[i+15:i]
    ELSE
      IF *merging-masking* ; merging-masking
        THEN *DEST[i+15:i] remains unchanged*
        ELSE DEST[i+15:i] := 0 ; zeroing-masking
      FI
    FI;
ENDFOR
DEST[MAXVL-1:VL] := 0

```

**VMOVRSD DEST, SRC (EVEX Encoded Version)**

(KL, VL) = (4, 128), (8, 256), (16, 512)

```

FOR j := 0 TO KL-1
  i := j * 32
  IF k1[j] OR *no writemask*
    THEN DEST[i+31:i] := SRC[i+31:i]
  ELSE
    IF *merging-masking* ; merging-masking
      THEN *DEST[i+31:i] remains unchanged*
    ELSE DEST[i+31:i] := 0 ; zeroing-masking
    FI
  FI;
ENDFOR
DEST[MAXVL-1:VL] := 0

```

**VMOVRSQ DEST, SRC (EVEX Encoded Version)**

(KL, VL) = (2, 128), (4, 256), (8, 512)

```

FOR j := 0 TO KL-1
  i := j * 64
  IF k1[j] OR *no writemask*
    THEN DEST[i+63:i] := SRC[i+63:i]
  ELSE
    IF *merging-masking* ; merging-masking
      THEN *DEST[i+63:i] remains unchanged*
    ELSE DEST[i+63:i] := 0 ; zeroing-masking
    FI
  FI;
ENDFOR
DEST[MAXVL-1:VL] := 0

```

**Flags Affected**

None.

**SIMD Floating-Point Exceptions**

None.

**Exceptions**

Exceptions Type Legacy-MOVRSD; see Table 2-1.

EVEX-encoded instruction, see Table 2-49, "Type E4 Class Exception Conditions," in the Intel® 64 and IA-32 Architectures Software Developer's Manual, Volume 2A.



Table 2-1. Type Legacy-MOVRS Class Exception Conditions

Exception	Real	Virtual-8086	Protected and Compatibility	64-bit	Cause of Exception
Invalid Opcode, #UD	X	X	X		Only supported in 64-bit mode.
				X	If preceded by a LOCK prefix (F0H) or REP prefix (F2H, F3H).
				X	If any corresponding CPUID feature flag is '0'.
Stack, #SS(0)				X	If a memory address referencing the SS segment is in a non-canonical form.
Alignment Check #AC(0)				X	If alignment checking is enabled and an unaligned memory access is made while CPL=3.
General Protection, #GP(0)				X	If the memory address is in a non-canonical form.
Page Fault, #PF(fault-code)				X	For a page fault.

## PBNDKB—Platform Bind Key to Binary Large Object

Opcode/ Instruction	Op/ En	64/32 bit Mode Support	CPUID Feature Flag	Description
NP 0F 01 C7 PBNDKB	Z0	V/I	PBNDKB	This instruction is used to bind information to a platform by encrypting it with a platform-specific wrapping key.

### Instruction Operand Encoding

Op/En	Operand 1	Operand 2	Operand 3	Operand 4
Z0	N/A	N/A	N/A	N/A

### Description

The PBNDKB instruction allows software to bind information to a platform by encrypting it with a platform-specific wrapping key. The encrypted data may later be used by the PCONFIG instruction to configure the total storage encryption (TSE) engine.<sup>1</sup>

The instruction can be executed only in 64-bit mode. The registers RBX and RCX provide input information to the instruction. Executions of PBNDKB may fail for platform-specific reasons. An execution reports failure by setting the ZF flag and loading EAX with a non-zero failure reason; a successful execution clears ZF and EAX.

The instruction operates on 256-byte data structures called **bind structures**. It reads a bind structure at the linear address in RBX and writes a modified bind structure to the linear address in RCX. The addresses in RBX and RCX must be different from each other and must be 256-byte aligned.

The instruction encrypts a portion of the input bind structure and generates a MAC of parts of that structure. The encrypted data and MAC are written out as part of the output bind structure.

The format of a bind structure is given in Table 2-1.

**Table 2-1. Bind Structure Format**

Field	Offset (bytes)	Size (bytes)	Comments
MAC	0	16	Output by PBNDKB as a MAC based on the input bind structure
Reserved	16	8	Reserved; must be zero on input, output as zero
IV	24	12	Initialization vector generated and output by PBNDKB
Reserved	36	28	Reserved; must be zero on input, output as zero
BTENCDATA	64	64	Encryption data (plaintext on input; ciphertext on output)
BTDATA	128	128	Additional control and data (modified but not encrypted)

A description of each of the fields in a bind structure is provided below:

- **MAC:** A MAC produced by PBNDKB of parts of its input bind structure. This field in the input bind structure is not used.
- **IV:** PBNDKB randomly generates a 96-bit initialization vector and uses it as input to an authenticated encryption function. The generated IV is written to the output bind structure. If there is insufficient entropy for the random-number generator, PBNDKB will fail and report the failure by loading EAX with value 1 (ENTROPY\_ERROR). This field in the input bind structure is not used.
- **BTENCDATA:** In the input bind structure, the field contains the data to be encrypted. The data consist of two 256-bit keys, a data key and a tweak key. If the value of the KEY\_GENERATION\_CTRL field of the BTDATA (see below) is 1, PBNDKB randomizes the values of these keys before encrypting them. (If there is insufficient entropy for the random-number generator, PBNDKB will fail and report the failure by loading EAX with value 1 (ENTROPY\_ERROR).) PBNDKB writes the encrypted data to this field in the output bind structure.

1. For details on Total Storage Encryption (TSE), see Chapter 6 of this document.

- **BTDATA:** This field contains additional control and data that are not encrypted. It has the following format:
  - **USER\_SUPP\_CHALLENGE** (bytes 31:0): PBNDKB uses this value in the input bind structure to determine the wrapping key (see below). It writes zero to this field in the output bind structure.
  - **KEY\_GENERATION\_CTRL** (byte 32): PBNDKB uses this value in the input bind structure to determine whether to randomize the keys being encrypted. The value must be 0 or 1 (otherwise, a #GP occurs).
  - The remaining 95 bytes are reserved and must be zero.

PBNDKB determines a 256-bit **wrapping key** by computing an HMAC based on SHA-256 using 256-bit platform-specific key and the USER\_SUPP\_CHALLENGE in the BTDATA field in the input bind structure.

PBNDKB then uses the wrapping key and an AES GCM authenticated encryption function to encrypt BTENCDATA and produce a MAC. The encryption function uses the following inputs:

- The 64-byte BTENCDATA to be encrypted (which may have been randomized; see above).
- The 256-bit wrapping key.
- The 96-bit IV randomly generated by PBNDKB.
- 176 bytes of additional authenticated data that are the concatenation of 8 bytes of zeroes, the IV, 28 bytes of zeroes, and the BTDATA in the input bind structure.
- The length of the additional authenticated data (176).

The encryption function produces a structure with 64 bytes of encrypted data and a 16-byte MAC. PBNDKB saves these values to the corresponding fields in its output bind structure. Other fields are copied from the input bind structure or written as zero, except the IV (which receives the randomly generated value) and the USER\_SUPP\_CHALLENGE in the BTDATA, which is written as zero.

## Operation

(\* #UD if PBNDKB is not enumerated, CPL > 0, or not in 64-bit mode\*)

```
IF CPUID.(EAX=07H, ECX=01H);EBX.PBNDKB[bit 1] = 0 OR CPL > 0 OR not in 64-bit mode
  THEN #UD; FI;
```

(\* #GP if pointers are not aligned or overlapping \*)

```
IF RBX = RCX OR RBX is not 256-byte aligned OR RCX is not 256-byte aligned
  THEN #GP(0); FI;
```

Load TMP\_BIND\_STRUCT from 256 bytes at linear address in RBX;

(\* MAC and IV fields might not be read. \*)

(\* Check TMP\_BIND\_STRUCT for illegal values \*)

```
IF bytes 23:16 and bytes 63:36 of TMP_BIND_STRUCT are not all zero
  THEN #GP(0); FI;
```

```
IF TMP_BIND_STRUCT.BTDATA.KEY_GENERATION_CTRL > 1
  THEN #GP(0); FI;
```

```
IF bytes 127:33 of TMP_BIND_STRUCT.BTDATA are not all zero
  THEN #GP(0); FI;
```

(\* Randomize input keys if requested \*)

```
IF TMP_BIND_STRUCT.BTDATA.KEY_GENERATION_CONTROL = 1
  THEN
```

```
  Load RNG_DATA_KEY with a random 256-bit value using hardware RNG;
```

```
  Load RNG_TWEAK_KEY with a random 256-bit value using hardware RNG;
```

```
  IF there was insufficient entropy
```

```
    THEN (* PBNDKB failure *)
```

```
      RFLAGS.ZF := 1;
```

```
      RAX := ENTROPY_ERROR; (* failure reason 1 *)
```

```
      GOTO EXIT;
```

```
FI;
```

```
(* XOR the input keys with the random keys; this does not modify input bind structure in memory *)
TMP_BIND_STRUCT.BTENCADATA.DATA_KEY := RNG_DATA_KEY XOR TMP_BIND_STRUCT.BTENCADATA.DATA_KEY;
TMP_BIND_STRUCT.BTENCADATA.TWEAK_KEY := RNG_TWEAK_KEY XOR TMP_BIND_STRUCT.BTENCADATA.TWEAK_KEY;
```

```
FI;
```

```
(* Compute wrapping key from platform key and user challenge *)
PLATFORM_KEY := 256-bit platform-specific key;
WRAPPING_KEY := HMAC_SHA256(PLATFORM_KEY, TMP_BIND_STRUCT.BTENCADATA.USER_SUPP_CHALLENGE);
```

```
(* Generate random data for initialization vector *)
Load TMP_IV with a random 96-bit value using hardware RNG;
IF there was insufficient entropy
  THEN (* PBNDKB failure *)
    RFLAGS.ZF := 1;
    RAX := ENTROPY_ERROR; (* failure reason 1 *)
    GOTO EXIT;
```

```
FI;
```

```
(* Compose 176 bytes of additional authenticated data for use by authenticated decryption *)
AAD := Concatenation of 8 bytes of zeroes, TMP_IV, 28 bytes of zeroes, and TMP_BIND_STRUCT.BTENCADATA;
```

```
ENCRYPT_STRUCT := AES256_GCM_ENC(TMP_BIND_STRUCT.BTENCADATA, WRAPPING_KEY, TMP_IV, AAD, 176);
```

```
OUT_BIND_STRUCT.MAC := ENCRYPT_STRUCT.MAC;
OUT_BIND_STRUCT[bytes 23:16] := 0;
OUT_BIND_STRUCT.IV := TMP_IV;
OUT_BIND_STRUCT[bytes 63:36] := 0;
OUT_BIND_STRUCT.BTENCADATA := ENCRYPT_STRUCT.ENC_DATA;
OUT_BIND_STRUCT.BTENCADATA.USER_SUPP_CHALLENGE := 0;
OUT_BIND_STRUCT.BTENCADATA.KEY_GENERATION_CTRL := IN_BIND_STRUCT.BTENCADATA.KEY_GENERATION_CTRL;
OUT_BIND_STRUCT.BTENCADATA[bytes 127:33] := 0;
```

```
(* Save OUT_BIND_STRUCT to memory *)
Store OUT_BIND_STRUCT to 256 bytes at linear address in RCX;
```

```
(* Indicate successful completion *)
RAX := 0;
RFLAGS.ZF := 0;
```

```
EXIT:
RFLAGS.CF := 0;
RFLAGS.PF := 0;
RFLAGS.AF := 0;
RFLAGS.OF := 0;
RFLAGS.SF := 0;
```

### Protected Mode Exceptions

#UD PBNDKB is not supported in protected mode.

### Real-Address Mode Exceptions

#UD PBNDKB is not supported in real-address mode.

### Virtual-8086 Mode Exceptions

#UD PBNDKB is not supported in virtual-8086 mode.

### Compatibility Mode Exceptions

Same exceptions as in protected mode.

### 64-Bit Mode Exceptions

#GP(0) If the values of RBX and RCX are not both canonical.  
If RBX or RCX is not 256B aligned.  
If RBX = RCX.  
If any of the reserved bytes in the input bind structure are set (including bytes in BTDATA).  
If the value of the key-generation control in the BTDATA field of the input bind structure is not 0 or 1.

#PF(fault-code) If a page fault occurs in accessing memory operands.

#UD If any of the LOCK/REP/Operand Size/VEX prefixes are used.  
If the current privilege level is not 0.  
If CPUID.(EAX=07H, ECX=01H):EBX.PBNDKB[bit 1] = 0.

## PCONFIG—Platform Configuration

Opcode/ Instruction	Op/ En	64/32 bit Mode Support	CPUID Feature Flag	Description
NP OF 01 C5 PCONFIG	A	V/V	PCONFIG	This instruction is used to execute functions for configuring platform features.

### Instruction Operand Encoding

Op/En	Tuple Type	Operand 1	Operand 2	Operand 3	Operand 4
A	N/A	N/A	N/A	N/A	N/A

### Description

The PCONFIG instruction allows software to configure certain platform features. It supports these features with multiple leaf functions, selecting a leaf function using the value in EAX.

Depending on the leaf function, the registers RBX, RCX, and RDX may be used to provide input information or for the instruction to report output information. Addresses and operands are 32 bits outside 64-bit mode and are 64 bits in 64-bit mode. The value of CS.D does not affect operand size or address size.

Executions of PCONFIG may fail for platform-specific reasons. An execution reports failure by setting the ZF flag and loading EAX with a non-zero failure reason; a successful execution clears ZF and EAX.

Each PCONFIG leaf function applies to a specific hardware block called a PCONFIG target. The leaf function is supported only if the processor supports that target. Each target is associated with a numerical target identifier, and CPUID leaf 1BH (PCONFIG information) enumerates the identifiers of the supported targets. An attempt to execute an undefined leaf function, or a leaf function that applies to an unsupported target identifier, results in a general-protection exception (#GP).

### Leaf Function MKTME\_KEY\_PROGRAM

PCONFIG leaf function 0 (selected by loading EAX with value 0) is used for key programming for total memory encryption-multi-key (TME-MK).<sup>1</sup> This leaf function is called MKTME\_KEY\_PROGRAM and it pertains to the TME-MK target, which has target identifier 1. The leaf function uses the EBX (or RBX) register for additional input information.

Software uses this leaf function to manage the encryption key associated with a particular key identifier (KeyID). The leaf function uses a data structure called the **TME-MK key programming structure** (MKTME\_KEY\_PROGRAM\_STRUCT). Software provides the address of the structure (as an offset in the DS segment) in EBX (or RBX). The format of the structure is given in Table 2-2.

**Table 2-2. MKTME\_KEY\_PROGRAM\_STRUCT Format**

Field	Offset (bytes)	Size (bytes)	Comments
KEYID	0	2	Key Identifier.
KEYID_CTRL	2	4	KeyID control: <ul style="list-style-type: none"> <li>▪ Bits 7:0: key-programming command (COMMAND)</li> <li>▪ Bits 23:8: encryption algorithm (ENC_ALG)</li> <li>▪ Bits 31:24: Reserved, must be zero (RSVD)</li> </ul>
Ignored	6	58	Not used.
KEY_FIELD_1	64	64	Software supplied data key or entropy for data key.
KEY_FIELD_2	128	64	Software supplied tweak key or entropy for tweak key.

1. Further details on TME-MK can be found here:

<https://software.intel.com/sites/default/files/managed/a5/16/Multi-Key-Total-Memory-Encryption-Spec.pdf>

A description of each of the fields in MKTME\_KEY\_PROGRAM\_STRUCT is provided below:

- **KEYID:** The key identifier (KeyID) being programmed to the MKTME engine. The leaf function causes a general-protection exception (#GP) if the KeyID is zero. KeyID zero always uses the current behavior configured for TME (total memory encryption), either to encrypt with platform TME key or to bypass TME encryption. The leaf function also causes a #GP if the KeyID exceeds the maximum enumerated in IA32\_TME\_CAPABILITY.MK\_TME\_MAX\_KEYS[bits 50:36] or configured by the setting of IA32\_TME\_ACTIVATE.MK\_TME\_KEYID\_BITS[bits 35:32].
- **KEYID\_CTRL:** The KEYID\_CTRL field comprises two sub-fields used by software to control the encryption performed for the selected KeyID:
  - Key-programming command (COMMAND; bits 7:0). This 8-bit field should contain one of the following values:
    - KEYID\_SET\_KEY\_DIRECT (value 0). With this command, software programs directly the encryption key to be used for the selected KeyID.
    - KEYID\_SET\_KEY\_RANDOM (value 1). With this command, software has the CPU generate and assign an encryption key to be used for the selected KeyID using a hardware random-number generator.
 

If this command is used and there is insufficient entropy for the random-number generator, the leaf function will fail and report the failure by loading EAX with value 2 (ENTROPY\_ERROR).

Because the keys programed by this leaf function are discarded on reset and software cannot read the programmed keys, the keys programmed with this command are ephemeral.
    - KEYID\_CLEAR\_KEY (value 2). With this command, software indicates that the selected KeyID should use the current behavior configured for TME (see above).
    - KEYID\_NO\_ENCRYPT (value 3). With this command, software indicates that no encryption should be used for the selected KeyID.

If any other value is used, the leaf function causes a #GP.

- Encryption algorithm (ENC\_ALG, bits 23:8). Bits 63:48 of the IA32\_TME\_ACTIVATE MSR (MSR index 982H) indicate which encryption algorithms are supported by the platform. The 16-bit ENC\_ALG field should specify one of the algorithms indicated in IA32\_TME\_ACTIVATE. The leaf function causes a #GP if ENC\_ALG does not set exactly one bit or if it sets a bit whose corresponding bit is not set in IA32\_TME\_ACTIVATE[63:48].
- **KEY\_FIELD\_1:** Use of this field depends upon selected key-programming command:
  - If the direct key-programming command is used (KEYID\_SET\_KEY\_DIRECT), this field carries the software-supplied data key to be used for the KeyID.
  - If the random key-programming command is used (KEYID\_SET\_KEY\_RANDOM), this field carries the software-supplied entropy to be mixed in the CPU generated random data key.
  - This field is ignored when one of the other key-programming commands is used.

It is software's responsibility to ensure that the key supplied for the direct key-programming option or the entropy supplied for the random key-programming option does not result in weak keys. There are no explicit checks in the instruction to detect or prevent weak keys.
- **KEY\_FIELD\_2:** Use of this field depends upon selected key-programming command:
  - If the direct key-programming command is used (KEYID\_SET\_KEY\_DIRECT), this field carries the software-supplied tweak key to be used for the KeyID.
  - If the random key-programming command is used (KEYID\_SET\_KEY\_RANDOM), this field carries the software-supplied entropy to be mixed in the CPU generated random tweak key.
  - This field is ignored when one of the other key-programming commands is used.

It is software's responsibility to ensure that the key supplied for the direct key-programming option or the entropy supplied for the random key-programming option does not result in weak keys. There are no explicit checks in the instruction to detect or prevent weak keys.

All KeyIDs default to TME behavior (encrypt with TME key or bypass encryption) on activation of TME-MK. Software can at any point decide to change the key for a KeyID using this leaf function. Changing the key for a KeyID does

**not** change the state of the TLB caches or memory pipeline. Software is responsible for taking appropriate actions to ensure correct behavior.

The key table used by TME-MK is shared by all logical processors in a platform. For this reason, execution of this leaf function must gain exclusive access to the key table before updating it. The leaf function does this by acquiring a lock (implemented in the platform) and retaining that lock until the execution completes. An execution of the leaf function may fail to acquire the lock if it is already in use. In this situation, the leaf function will load EAX with failure reason 5 (DEVICE\_BUSY). When this happens, the key table is not updated, and software should retry execution of PCONFIG.

### Leaf Function TSE\_KEY\_PROGRAM

PCONFIG leaf function 1 (selected by loading EAX with value 1) is used for direct key programming for total storage encryption (TSE). This leaf function is called TSE\_KEY\_PROGRAM and it pertains to the TSE target, which has target identifier 2. The leaf function can be used only in 64-bit mode. It uses the RBX register for additional input information.

Software uses this leaf function to manage the encryption key associated with a particular key identifier (KeyID). The leaf function uses a data structure called the **TSE key programming structure** (TSE\_KEY\_PROGRAM\_STRUCTURE). Software provides the linear address of the structure in RBX. The format of the structure is given in Table 2-3.

**Table 2-3. TSE\_KEY\_PROGRAM\_STRUCTURE Format**

Field	Offset (bytes)	Size (bytes)	Comments
KEYID	0	2	Key Identifier.
KEYID_CTRL	2	4	KeyID control: <ul style="list-style-type: none"> <li>▪ Bits 7:0: key-programming command (COMMAND)</li> <li>▪ Bits 23:8: encryption algorithm (ENC_ALG)</li> <li>▪ Bits 31:24: Reserved, must be zero (RSVD)</li> </ul>
Ignored	6	58	Not used.
KEY_FIELD_1	64	64	Software supplied data key.
KEY_FIELD_2	128	64	Software supplied tweak key.

A description of each of the fields in MKTME\_KEY\_PROGRAM\_STRUCTURE is provided below:

- **KEYID:** The key identifier (KeyID) being programmed to the TSE engine. The leaf function causes a general-protection exception (#GP) if the KeyID exceeds the maximum enumerated in the TSE\_MAX\_KEYS field (bits 50:36) of the IA32\_TSE\_CAPABILITY MSR (MSR index 9F1H).
- **KEYID\_CTRL:** The KEYID\_CTRL field comprises two sub-fields used by software to control the encryption performed for the selected KeyID:
  - Key-programming command (COMMAND; bits 7:0). This 8-bit field should contain one of the following values:
    - TSE\_SET\_KEY\_DIRECT (value 0). With this command, software programs directly the encryption key to be used for the selected KeyID.
    - TSE\_NO\_ENCRYPT (value 1). With this command, software indicates that no encryption should be used for the selected KeyID.

If any other value is used, the leaf function causes a #GP.

- Encryption algorithm (ENC\_ALG, bits 23:8). IA32\_TSE\_CAPABILITY[15:0] indicates which encryption algorithms are supported by the platform. The 16-bit ENC\_ALG field should specify one of the algorithms indicated in IA32\_TSE\_CAPABILITY. The leaf function causes a #GP if ENC\_ALG does not set exactly one bit or if it sets a bit whose corresponding bit is not set in IA32\_TSE\_CAPABILITY.
- **KEY\_FIELD\_1:** If the direct key-programming command is used (TSE\_SET\_KEY\_DIRECT), this field carries the software supplied data key to be used for the KeyID. Otherwise, the field is ignored.



- **KEY\_FIELD\_2:** If the direct key-programming command is used (TSE\_SET\_KEY\_DIRECT), this field carries the software supplied tweak key to be used for the KeyID. Otherwise, the field is ignored.

The TSE key table is shared by all logical processors in a platform. For this reason, execution of this leaf function must gain exclusive access to the key table before updating it. The leaf function does this by acquiring a lock (implemented in the platform) and retaining that lock until the execution completes. An execution of the leaf function may fail to acquire the lock if it is already in use. In this situation, the leaf function will load EAX with failure reason 5 (DEVICE\_BUSY). When this happens, the key table is not updated, and software should retry execution of PCONFIG.

### Leaf Function TSE\_KEY\_PROGRAM\_WRAPPED

PCONFIG leaf function 2 (selected by loading EAX with value 2) is used for wrapped key programming for total storage encryption (TSE). This leaf function is called TSE\_KEY\_PROGRAM\_WRAPPED and it pertains to the TSE target, which has target identifier 2. The leaf function can be used only in 64-bit mode. It uses the RBX and RCX registers for additional input information.

Software uses this leaf function to manage the encryption key associated with a particular key identifier (KeyID). The leaf function uses control input provided in RBX. The format of that input is given in Table 2-4.

**Table 2-4. TSE\_KEY\_PROGRAM\_WRAPPED Control Input**

Field	Bit Positions	Comments
KEYID	15:0	Key identifier.
Reserved	23:16	Reserved, must be zero.
ENC_ALG	39:24	Encryption algorithm.
Ignored	63:40	Not used.

A description of each of the fields in the control input is provided below:

- **KEYID:** The key identifier (KeyID) being programmed to the TSE engine. The leaf function causes a general-protection exception (#GP) if the KeyID exceeds the maximum enumerated in the TSE\_MAX\_KEYS field (bits 50:36) of the IA32\_TSE\_CAPABILITY MSR (MSR index 9F1H).
- **ENC\_ALG:** The encryption algorithm selected for the KeyID. IA32\_TSE\_CAPABILITY[15:0] indicates which encryption algorithms are supported by the platform. The 16-bit ENC\_ALG field should specify one of the algorithms indicated in IA32\_TSE\_CAPABILITY. The leaf function causes a #GP if ENC\_ALG does not set exactly one bit or if it sets a bit whose corresponding bit is not set in IA32\_TSE\_CAPABILITY.

The leaf function also uses a 256-byte data structure called the **bind structure**. This structure should be the output of the PBNDKB instruction, subsequently modified by software (see below). Software provides the linear address of the structure in RCX. The format of the structure is given in Table 2-5.

**Table 2-5. Bind Structure Format**

Field	Offset (bytes)	Size (bytes)	Comments
MAC	0	16	MAC produced by PBNDKB of its input bind structure
Reserved	16	8	Reserved, must be zero.
IV	24	12	Initialization vector.
Reserved	36	28	Reserved, must be zero.
BTENCDATA	64	64	Encrypted data (data key and tweak key)
BTDATA	128	128	Additional control and data (not encrypted)

A description of each of the fields in TSE\_BIND\_STRUCT is provided below:

- **MAC:** A MAC produced by PBNDKB of its input bind structure. The PCONFIG leaf function will recompute the MAC and confirm that it matches this value.

- **IV:** The initialization vector that PBNDKB used for encryption. The PCONFIG leaf function will use this in its decryption of encrypted data and computation of the MAC.
- **BTENCDATA:** Data which had been encrypted by PBNDKB, containing the data and tweak keys to be used by TSE.
- **BTDATA:** Data that was input to PBNDKB that was output without encryption. It has the following format:
  - **USER\_SUPP\_CHALLENGE** (bytes 31:0): PBNDKB uses a value provided by software in its input bind structure but writes zero to this field in the output bind structure to be used by PCONFIG. Software should configure this field with the proper value before executing this PCONFIG leaf function.
  - **KEY\_GENERATION\_CTRL** (byte 32): PBNDKB uses this value to determine whether to generate random keys. The PCONFIG leaf function does not use this field.
  - The remaining 95 bytes are reserved and must be zero.

The leaf function uses the entire BTDATA field when it computes the MAC.

The leaf function determines a 256-bit **wrapping key** by computing an HMAC based on SHA-256 using 256-bit platform-specific key and the USER\_SUPP\_CHALLENGE in the BTDATA field of the TSE\_BIND\_STRUCT.

Using the wrapping key, the leaf function uses an AES GCM authenticated decryption function to decrypt BTENCDATA and compute a MAC. The decryption function uses the following inputs:

- The 64-byte BTENCDATA from TSE\_BIND\_STRUCT to be decrypted.
- The 256-bit wrapping key.
- The 96-bit IV from TSE\_BIND\_STRUCT.
- Additional authenticated data that is the concatenation of bytes 63:16 and bytes 255:128 of the TSE\_BIND\_STRUCT. These 176 bytes will comprise 8 bytes of zeroes, the 12-byte IV, 28 bytes of zeroes, and 128 bytes of BTDATA of which the upper 95 bytes are zero).
- The length of the additional authenticated data (176).

The decryption function produces a structure with a 64 bytes of decrypted data and a 16-byte MAC. The decrypted data comprises a 256-bit data key and a 256-bit tweak key.

If the MAC produced by the decryption function differs from that provided in the TSE\_BIND\_STRUCT, the leaf function will load EAX with failure reason 7 (UNWRAP\_FAILURE). Otherwise, the leaf function will attempt to program the TSE key table for the selected KeyID with the keys contained in the decrypted data.

The TSE key table is shared by all logical processors in a platform. For this reason, execution of this leaf function must gain exclusive access to the key table before updating it. The leaf function does this by acquiring a lock (implemented in the platform) and retaining that lock until the execution completes. An execution of the leaf function may fail to acquire the lock if it is already in use. In this situation, the leaf function will load EAX with failure reason 5 (DEVICE\_BUSY). When this happens, the key table is not updated, and software should retry execution of PCONFIG.

## Operation

(\* #UD if PCONFIG is not enumerated or CPL > 0 \*)

```
IF CPUID.(EAX=07H, ECX=0H):EDX.PCONFIG[bit 18] = 0 OR CPL > 0
  THEN #UD; FI;
```

(\* #GP(0) for an unsupported leaf function \*)

```
IF EAX > 2
  THEN #GP(0); FI;
```

CASE (EAX) (\* operation based on selected leaf function \*)

```
0 (MKTME_KEY_PROGRAM):
```

```
IF CPUID function 1BH does not enumerate support for the TME-MK target (value 1)
  THEN #GP(0); FI;
```

(\* Confirm that TME-MK is properly enabled by the IA32\_TME\_ACTIVATE MSR \*)

(\* The MSR must be locked, encryption enabled, and a non-zero number of KeyID bits specified \*)

```
IF IA32_TME_ACTIVATE[0] = 0 OR IA32_TME_ACTIVATE[1] = 0 OR IA32_TME_ACTIVATE[35:32] = 0
```

```

        THEN #GP(0); FI;

IF DS:RBX is not 256-byte aligned
    THEN #GP(0); FI;

Load TMP_KEY_PROGRAM_STRUCT from 192 bytes at linear address DS:RBX;

IF TMP_KEY_PROGRAM_STRUCT.KEYID_CTRL sets any reserved bits
    THEN #GP(0); FI;

(* Check for a valid command *)
IF TMP_KEY_PROGRAM_STRUCT.KEYID_CTRL.COMMAND > 3
    THEN #GP(0); FI;

(* Check that the KEYID being operated upon is a valid KEYID *)
IF TMP_KEY_PROGRAM_STRUCT.KEYID = 0 OR
    TMP_KEY_PROGRAM_STRUCT.KEYID > 2^IA32_TME_ACTIVATE.MK_TME_KEYID_BITS - 1 OR
    TMP_KEY_PROGRAM_STRUCT.KEYID > IA32_TME_CAPABILITY.MK_TME_MAX_KEYS
    THEN #GP(0); FI;

(* Check that only one encryption algorithm is requested for the KeyID and it is one of the activated algorithms *)
IF TMP_KEY_PROGRAM_STRUCT.KEYID_CTRL.ENC_ALG does not set exactly one bit OR
    (TMP_KEY_PROGRAM_STRUCT.KEYID_CTRL.ENC_ALG & IA32_TME_ACTIVATE[63:48]) = 0
    THEN #GP(0); FI;

Attempt to acquire lock to gain exclusive access to platform key table for TME-MK;
IF attempt is unsuccessful
    THEN (* PCONFIG failure *)
        RFLAGS.ZF := 1;
        RAX := DEVICE_BUSY; (* failure reason 5 *)
        GOTO EXIT;
FI;

CASE (TMP_KEY_PROGRAM_STRUCT.KEYID_CTRL.COMMAND) OF
    0 (KEYID_SET_KEY_DIRECT):
        Update TME-MK table for TMP_KEY_PROGRAM_STRUCT.KEYID as follows:
            Encrypt with the selected key
            Use the encryption algorithm selected by TMP_KEY_PROGRAM_STRUCT.KEYID_CTRL.ENC_ALG
            (* The number of bytes used by the next two lines depends on selected encryption algorithm *)
            DATA_KEY is TMP_KEY_PROGRAM_STRUCT.KEY_FIELD_1
            TWEAK_KEY is TMP_KEY_PROGRAM_STRUCT.KEY_FIELD_2
        BREAK;

    1 (KEYID_SET_KEY_RANDOM):
        Load TMP_RND_DATA_KEY with a random key using hardware RNG; (* key size depends on selected encryption algorithm *)
        IF there was insufficient entropy
            THEN (* PCONFIG failure *)
                RFLAGS.ZF := 1;
                RAX := ENTROPY_ERROR; (* failure reason 2 *)
                Release lock on platform key table;
                GOTO EXIT;
        FI;
        Load TMP_RND_TWEAK_KEY with a random key using hardware RNG; (* key size depends on selected encryption algorithm *)
        IF there was insufficient entropy

```

```

    THEN (* PCONFIG failure *)
        RFLAGS.ZF := 1;
        RAX := ENTROPY_ERROR; (* failure reason 2 *)
        Release lock on platform key table;
        GOTO EXIT;
FI;
(* Combine software-supplied entropy to the data key and tweak key *)
(* The number of bytes used by the next two lines depends on selected encryption algorithm *)
TMP_RND_DATA_KEY := TMP_RND_KEY XOR TMP_KEY_PROGRAM_STRUCT.KEY_FIELD_1;
TMP_RND_TWEAK_KEY := TMP_RND_TWEAK_KEY XOR TMP_KEY_PROGRAM_STRUCT.KEY_FIELD_2;

Update TME-MK table for TMP_KEY_PROGRAM_STRUCT.KEYID as follows:
    Encrypt with the selected key
    Use the encryption algorithm selected by TMP_KEY_PROGRAM_STRUCT.KEYID_CTRL.ENC_ALG
    (* The number of bytes used by the next two lines depends on selected encryption algorithm *)
    DATA_KEY is TMP_RND_DATA_KEY
    TWEAK_KEY is TMP_RND_TWEAK_KEY
BREAK;

2 (KEYID_CLEAR_KEY):
Update TME-MK table for TMP_KEY_PROGRAM_STRUCT.KEYID as follows:
    Encrypt (or not) using the current configuration for TME
    The specified encryption algorithm and key values are not used.
BREAK;

3 (KEYID_NO_ENCRYPT):
Update TME-MK table for TMP_KEY_PROGRAM_STRUCT.KEYID as follows:
    Do not encrypt
    The specified encryption algorithm and key values are not used.
BREAK;
ESAC;
Release lock on platform key table for TME-MK;

1 (TSE_KEY_PROGRAM):
IF CPUID function 1BH does not enumerate support for the TSE target (value 2)
    THEN #GP(0); FI;

IF not in 64-bit mode
    THEN #GP(0); FI;

IF RBX is not 256-byte aligned
    THEN #GP(0); FI;

Load TMP_KEY_STRUCT from 192 bytes at linear address in RBX;

IF TMP_KEY_STRUCT.KEYID_CTRL sets any reserved bits
    THEN #GP(0); FI;

(* Check for a valid command *)
IF TMP_KEY_STRUCT.KEYID_CTRL.COMMAND > 1
    THEN #GP(0); FI;

(* Check that the KEYID being operated upon is a valid KEYID *)
IF TMP_KEY_STRUCT.KEYID > IA32_TSE_CAPABILITY.TSE_MAX_KEYS

```

```
THEN #GP(0); FI;
```

```
(* Check that only one encryption algorithm is requested for the KeyID and it is one of the activated algorithms *)
```

```
IF TMP_KEY_STRUCT.KEYID_CTRL.ENC_ALG does not set exactly one bit OR
  (TMP_KEY_STRUCT.KEYID_CTRL.ENC_ALG & IA32_TSE_CAPABILITY[15:0]) = 0
  THEN #GP(0); FI;
```

```
Attempt to acquire lock to gain exclusive access to platform key table for TSE;
```

```
IF attempt is unsuccessful
```

```
  THEN (* PCONFIG failure *)
    RFLAGS.ZF := 1;
    RAX := DEVICE_BUSY; (* failure reason 5 *)
    GOTO EXIT;
```

```
FI;
```

```
CASE (TMP_KEY_STRUCT.KEYID_CTRL.COMMAND) OF
```

```
  0 (TSE_SET_KEY_DIRECT):
```

```
    Update TSE table for TMP_KEY_STRUCT.KEYID as follows:
```

```
      Encrypt with the selected key
```

```
      Use the encryption algorithm selected by TMP_KEY_STRUCT.KEYID_CTRL.ENC_ALG
```

```
      (* The number of bytes used by the next two lines depends on selected encryption algorithm *)
```

```
      DATA_KEY is TMP_KEY_STRUCT.KEY_FIELD_1
```

```
      TWEAK_KEY is TMP_KEY_STRUCT.KEY_FIELD_2
```

```
    BREAK;
```

```
  1 (TSE_NO_ENCRYPT):
```

```
    Update TSE table for TMP_KEY_STRUCT.KEYID as follows:
```

```
      Do not encrypt
```

```
      The specified encryption algorithm and key values are not used.
```

```
    BREAK;
```

```
ESAC;
```

```
Release lock on platform key table for TSE;
```

```
  2 (TSE_KEY_PROGRAM_WRAPPED):
```

```
    IF CPUID function 1BH does not enumerate support for the TSE target (value 2)
```

```
      THEN #GP(0); FI;
```

```
    IF not in 64-bit mode OR RBX[23:16] != 0 OR RCX is not 256-byte aligned
```

```
      THEN #GP(0); FI;
```

```
(* Check that the KEYID being operated upon is a valid KEYID *)
```

```
IF RBX[15:0] > IA32_TSE_CAPABILITY.TSE_MAX_KEYS
```

```
  THEN #GP(0); FI;
```

```
(* Check that only one encryption algorithm is requested for the KeyID and it is one of the activated algorithms *)
```

```
IF RBX[39:24] does not set exactly one bit OR (RBX[39:24] & IA32_TSE_CAPABILITY[15:0]) = 0
```

```
  THEN #GP(0); FI;
```

```
Load TMP_BIND_STRUCT from 256 bytes at linear address in RCX;
```

```
(* Check TMP_BIND_STRUCT for illegal values *)
```

```
IF bytes 23:16 and bytes 63:36 of TMP_BIND_STRUCT are not all zero
```

```
  THEN #GP(0); FI;
```

```
IF TMP_BIND_STRUCT.BTDATA.KEY_GENERATION_CTRL > 1
```

```

    THEN #GP(0); FI;
IF bytes 128:33 of TMP_BIND_STRUCT.BTDATA are not all zero
    THEN #GP(0); FI;

(* Compute wrapping key *)
PLATFORM_KEY := 256-bit platform-specific key;
WRAPPING_KEY := HMAC_SHA256(PLATFORM_KEY, TMP_BIND_STRUCT.BTDATA.USER_SUPP_CHALLENGE);

(* Compose 176 bytes of additional authenticated data for use by authenticated decryption *)
AAD := Concatenation of bytes 63:16 and bytes 255:128 of TMP_BIND_STRUCT;

DECRYPT_STRUCT := AES256_GCM_DEC(TMP_BIND_STRUCT.BTENCDATA, WRAPPING_KEY, TMP_BIND_STRUCT.IV, AAD, 176);

(* Fail if MAC mismatch *)
IF TMP_BIND_STRUCT.MAC != DECRYPT_STRUCT.MAC
    THEN
        RFLAGS.ZF := 1;
        RAX := UNWRAP_FAILURE; (* failure reason 7 *)
        GOTO EXIT;
FI;

Attempt to acquire lock to gain exclusive access to platform key table for TSE;
IF attempt is unsuccessful
    THEN (* PCONFIG failure *)
        RFLAGS.ZF := 1;
        RAX := DEVICE_BUSY; (* failure reason 5 *)
        GOTO EXIT;
FI;

Update TSE table for RBX[15:0] as follows:
    Encrypt with the selected key
    Use the encryption algorithm selected by RBX[39:24]
    (* The number of bytes used by the next two lines depends on selected encryption algorithm *)
    DATA_KEY is DECRYPT_STRUCT.DEC_DATA.KEY_FIELD_1
    TWEAK_KEY is DECRYPT_STRUCT.DEC_DATA.KEY_FIELD_2

Release lock on platform key table for TSE;

ESAC;

RAX := 0;
RFLAGS.ZF := 0;

EXIT:
RFLAGS.CF := 0;
RFLAGS.PF := 0;
RFLAGS.AF := 0;
RFLAGS.OF := 0;
RFLAGS.SF := 0;

```

## Protected Mode Exceptions

#GP(0)	<p>If input value in EAX encodes an unsupported leaf function.</p> <p>If a memory operand effective address is outside the relevant segment limit.</p> <p><b>MKTME_KEY_PROGRAM leaf function:</b></p> <p>If CPUID function 1BH does not enumerate support for the TME-MK target (value 1).</p> <p>If IA32_TME_ACTIVATE MSR is not locked.</p> <p>If hardware encryption and TME-MK capability are not enabled in IA32_TME_ACTIVATE MSR.</p> <p>If the memory operand is not 256B aligned.</p> <p>If any of the reserved bits in the KEYID_CTRL field of the MKTME_KEY_PROGRAM_STRUCT are set or that field indicates an unsupported KeyID, key-programming command, or encryption algorithm.</p> <p><b>TSE_KEY_PROGRAM leaf function:</b></p> <p>The TSE_KEY_PROGRAM leaf function is not supported in protected mode.</p> <p><b>TSE_KEY_PROGRAM_WRAPPED leaf function:</b></p> <p>The TSE_KEY_PROGRAM_WRAPPED leaf function is not supported in protected mode.</p>
#PF(fault-code)	If a page fault occurs in accessing memory operands.
#UD	<p>If any of the LOCK/REP/Operand Size/VEX prefixes are used.</p> <p>If current privilege level is not 0.</p> <p>If CPUID.(EAX=07H, ECX=0H):EDX.PCONFIG[bit 18] = 0</p>

## Real-Address Mode Exceptions

#GP	<p>If input value in EAX encodes an unsupported leaf function.</p> <p><b>MKTME_KEY_PROGRAM leaf function:</b></p> <p>If CPUID function 1BH does not enumerate support for the TME-MK target (value 1).</p> <p>If IA32_TME_ACTIVATE MSR is not locked.</p> <p>If hardware encryption and TME-MK capability are not enabled in IA32_TME_ACTIVATE MSR.</p> <p>If a memory operand is not 256B aligned.</p> <p>If any of the reserved bits in the KEYID_CTRL field of the MKTME_KEY_PROGRAM_STRUCT are set or that field indicates an unsupported KeyID, key-programming command, or encryption algorithm.</p> <p><b>TSE_KEY_PROGRAM leaf function:</b></p> <p>The TSE_KEY_PROGRAM leaf function is not supported in real-address mode.</p> <p><b>TSE_KEY_PROGRAM_WRAPPED leaf function:</b></p> <p>The TSE_KEY_PROGRAM_WRAPPED leaf function is not supported in real-address mode.</p>
#UD	<p>If any of the LOCK/REP/Operand Size/VEX prefixes are used.</p> <p>If current privilege level is not 0.</p> <p>If CPUID.(EAX=07H, ECX=0H):EDX.PCONFIG[bit 18] = 0</p>

## Virtual-8086 Mode Exceptions

#UD	PCONFIG instruction is not recognized in virtual-8086 mode.
-----	---

## Compatibility Mode Exceptions

Same exceptions as in protected mode.

## 64-Bit Mode Exceptions

#GP(0)	<p>If input value in EAX encodes an unsupported leaf function.</p> <p>If a memory operand is non-canonical form.</p> <p><b>MKTME_KEY_PROGRAM leaf function:</b></p> <p>IF CPUID function 1BH does not enumerate support for the TME-MK target (value 1).</p> <p>If IA32_TME_ACTIVATE MSR is not locked.</p> <p>If hardware encryption and TME-MK capability are not enabled in IA32_TME_ACTIVATE MSR.</p> <p>If a memory operand is not 256B aligned.</p> <p>If any of the reserved bits in the KEYID_CTRL field of the MKTME_KEY_PROGRAM_STRUCT are set or that field indicates an unsupported KeyID, key-programming command, or encryption algorithm.</p> <p><b>TSE_KEY_PROGRAM leaf function:</b></p> <p>IF CPUID function 1BH does not enumerate support for the TSE target (value 2).</p> <p>If RBX is not 256-byte aligned.</p> <p>If any of the reserved bits in the KEYID_CTRL field of the TMP_KEY_STRUCT are set or that field indicates an unsupported KeyID, key-programming command, or encryption algorithm.</p> <p><b>TSE_KEY_PROGRAM_WRAPPED leaf function:</b></p> <p>IF CPUID function 1BH does not enumerate support for the TSE target (value 2).</p> <p>If RCX is not 256-byte aligned.</p> <p>If any of the reserved bits in RBX are set or that register indicates an unsupported KeyID or encryption algorithm.</p> <p>If any of the reserved bytes in the TSE_BIND_STRUCT are set (including bytes in BTDATA).</p>
#PF(fault-code)	<p>If a page fault occurs in accessing memory operands.</p>
#UD	<p>If any of the LOCK/REP/Operand Size/VEX prefixes are used.</p> <p>If the current privilege level is not 0.</p> <p>If CPUID.(EAX=07H, ECX=0H):EDX.PCONFIG[bit 18] = 0.</p>



## PREFETCHRST2—Prefetch Data into Caches Using a Read-Shared Hint

Opcode / Instruction	Op/En	64/32 bit Mode Support	CPUID Feature Flag	Description
OF 18 !{(11):100:bbb PREFETCHRST2 m8	A	V/V	MOVRS	Move data from m8 closer to the processor using a read-shared hint.

### Instruction Operand Encoding

Op/En	Tuple Type	Operand 1	Operand 2	Operand 3	Operand 4
A	N/A	ModRM:r/m (r)	N/A	N/A	N/A

### Description

Fetches the line of data from memory that contains the byte specified with the source operand to a location in the cache hierarchy, in anticipation of this processor and at least one other reading the line before it is written, assuming it is ever written in the future. Brings data into an implementation-specific choice of cache, optimized for read sharing through shared cache levels. A future write to this data before it becomes read-shared will behave as usual, but its performance may be less optimal than if a prefetch or load without a read-shared hint were used for this access.

The source operand is a byte memory location.

Prefetches from uncacheable or WC memory are ignored.

The PREFETCHRST2 instruction is merely a hint and does not affect program behavior. If executed, this instruction moves data closer to the processor in anticipation of future use. The effect on the caches is implementation-dependent, and can be overloaded or ignored by a processor implementation. The amount of data prefetched is also processor implementation-dependent. It will, however, be a minimum of 32 bytes.

It should be noted that processors are free to speculatively fetch and cache data from system memory regions that are assigned a memory-type that permits speculative reads (that is, the WB, WC, and WT memory types). A PREFETCHRST2 instruction is considered a hint to this speculative behavior. Because this speculative fetching can occur at any time and is not tied to instruction execution, a PREFETCHRST2 instruction is not ordered with respect to the fence instructions (MFENCE, SFENCE, and LFENCE) or locked memory references. A PREFETCHRST2 instruction is also unordered with respect to CLFLUSH and CLFLUSHOPT instructions, other PREFETCHRST2 instructions, or any other general instruction. It is ordered with respect to serializing instructions such as CPUID, WRMSR, OUT, and MOV CR.

This instruction's operation is the same in non-64-bit modes and 64-bit mode.

### Operation

**PREFETCHRST2 m8**  
FETCH (m8)

### Flags Affected

None.

### SIMD Floating-Point Exceptions

None.

### Exceptions (All Operating Modes)

#UD If the LOCK prefix is used.

## RDMSR—Read From Model Specific Register

Opcode / <sup>1</sup> Instruction	Op/En	64/32 Bit Mode Support	CPUID Feature Flag	Description
OF 32 RDMSR	ZO	V/V		Read MSR specified by ECX into EDX:EAX.
VEX.128.F2.MAP7:W0.F6 11:000:bbb RDMSR r64, imm32	MI	V/N.E.	MSR_IMM	Load into register bbb the value of the MSR with address in the 32-bit immediate.
EVEX.128.F2.MAP7:W0.F6 11:000:bbb RDMSR r64, imm32	MI	V/N.E.	APX_F <sup>2</sup> AND MSR_IMM	Load into register bbb the value of the MSR with address in the 32-bit immediate.

### NOTES:

1. See the IA-32 Architecture Compatibility section below.
2. For more information on the Intel® APX instruction format, see the Intel® Advanced Performance Extensions Architecture Specification.

### Instruction Operand Encoding

Op/En	Operand 1	Operand 2	Operand 3	Operand 4
ZO	N/A	N/A	N/A	N/A
MI	ModRM:r/m (r)	imm32	N/A	N/A

### Description

Reads the contents of a 64-bit model specific register (MSR). RDMSR has an **implicit** form and an **immediate** form.

The implicit form reads the contents of the MSR specified in the ECX register into registers EDX:EAX. (On processors that support the Intel 64 architecture, the high-order 32 bits of RCX are ignored.) The EDX register is loaded with the high-order 32 bits of the MSR and the EAX register is loaded with the low-order 32 bits. (On processors that support the Intel 64 architecture, the high-order 32 bits of each of RAX and RDX are cleared.) If fewer than 64 bits are implemented in the MSR being read, the values returned to EDX:EAX in unimplemented bit locations are undefined.

The immediate form reads the contents of the MSR specified by operand 2 into operand 1. Operand 2 is an immediate, while operand 1 is a general-purpose register. The immediate form can be used only in 64-bit mode; otherwise, a invalid-opcode exception (#UD) will be generated. The immediate form may provide better performance than the implicit form.

This instruction must be executed at privilege level 0 or in real-address mode; otherwise, a general protection exception #GP(0) will be generated. Specifying a reserved or unimplemented MSR address in ECX will also cause a general protection exception.

The MSRs control functions for testability, execution tracing, performance-monitoring, and machine check errors. Chapter 2, “Model-Specific Registers (MSRs)” of the Intel® 64 and IA-32 Architectures Software Developer’s Manual, Volume 4, lists all the MSRs that can be read with this instruction and their addresses. Note that each processor family has its own set of MSRs.

The CPUID instruction should be used to determine whether MSRs are supported (CPUID.01H:EDX[5] = 1) before using this instruction. The immediate form is supported only if CPUID.(EAX=07H,ECX=01H):ECX.MSR\_IMM[bit 5] = 1.

### IA-32 Architecture Compatibility

The MSRs and the ability to read them with the RDMSR instruction were introduced into the IA-32 Architecture with the Pentium processor. Execution of this instruction by an IA-32 processor earlier than the Pentium processor results in an invalid opcode exception #UD.

See “Changes to Instruction Behavior in VMX Non-Root Operation” in Chapter 27 of the Intel® 64 and IA-32 Architectures Software Developer’s Manual, Volume 3C, for more information about the behavior of this instruction in VMX non-root operation.

### Operation

```
IF implicit form
  THEN
    EDX:EAX := MSR[ECX];
  ELSE (* immediate form *)
    DEST := MSR[SRC];
```

### Flags Affected

None.

### Protected Mode Exceptions

#GP(0) If the current privilege level is not 0.  
If the specified MSR address is reserved or unimplemented MSR.

#UD If the LOCK prefix is used.  
If the immediate form is used.

### Real-Address Mode Exceptions

#GP If the specified MSR address is reserved or unimplemented MSR.

#UD If the LOCK prefix is used.  
If the immediate form is used.

### Virtual-8086 Mode Exceptions

#GP(0) For the implicit form: the RDMSR instruction is not recognized in virtual-8086 mode.

#UD For the immediate form: the RDMSR instruction is not recognized in virtual-8086 mode.

### Compatibility Mode Exceptions

Same exceptions as in protected mode.

### 64-Bit Mode Exceptions

#GP(0) If the current privilege level is not 0.  
If the specified MSR address is reserved or unimplemented MSR.

#UD If the LOCK prefix is used.  
If the immediate form is used and CPUID.(EAX=07H, ECX=01H):ECX.MSR\_IMM[bit 5] = 0.

## URDMSR—User Read from Model-Specific Register

Opcode / Instruction	Op/En	64/32 bit Mode Support	CPUID Feature Flag	Description
F2 0F 38 F8 11:rrr:bbb URDMSR r64, r64	MR	V/N.E.	USER_MSR	Load into register bbb the value of the MSR with address in rrr.
VEX.128.F2.MAP7:W0.F8 11:000:bbb URDMSR r64, imm32	MI	V/N.E.	USER_MSR	Load into register bbb the value of the MSR with address in the 32-bit immediate.

### Instruction Operand Encoding

Op/En	Operand 1	Operand 2	Operand 3	Operand 4
MR	ModRM:r/m (r)	ModRM:reg (r)	N/A	N/A
MI	ModRM:r/m (r)	imm32	N/A	N/A

### Description

URDMSR reads the contents of a 64-bit MSR specified in operand 2 into operand 1. Operand 1 is a general-purpose register, while operand 2 may be either a general-purpose register or an immediate. URDMSR reads the indicated MSR in the same manner as RDMSR.

MSRs readable by RDMSR with CPL = 0 can be read by URDMSR at any privilege level but under OS control. The OS controls what MSRs can be read by the URDMSR and UWRMSR instructions with a 4-KByte bitmap located at an aligned linear address in the IA32\_USER\_MSR\_CTL (MSR address 1CH). The URDMSR instruction is enabled only if bit 0 of this MSR is 1.

The low 2 KBytes of the bitmap control URDMSR (they compose the URDMSR bitmap); the 2 KBytes includes one bit for each MSR address in the range 0H–3FFFH. URDMSR may read an MSR only if the bit corresponding to the MSR has value 1; otherwise (or if the MSR address is outside that range) URDMSR causes a general-protection exception (#GP).

The URDMSR accesses to these bitmaps are implicit supervisor-mode accesses, which means they use supervisor privilege regardless of CPL. The OS can create an alias to the bitmap in the user address space if it wants the application to know which MSRs are permitted. Still, the alias should be mapped read-only to prevent the application from overwriting the bitmap.

### Virtualization Behavior

Like RDMSR, execution of URDMSR in VMX non-root operation causes a VM exit if any of the following are true:

- The “use MSR bitmaps” VM-execution control is 0.
- The value of the MSR address is not in the range 00000000H–00001FFFH.
- The value of the MSR address is in the range 00000000H–00001FFFH, and bit n in the read bitmap for low MSRs is 1, where n is the value of the MSR address.

Such VM exits have priority below a #GP due to an MSR address outside the bitmap range or whose bit is clear in the bitmap. In enclave mode, URDMSR will cause a #GP(0) exception instead of a VM exit if any of the above conditions are true.

A VM exit for the above reasons for the URDMSR instruction will specify exit reason 80 (decimal). The exit qualification is set to the MSR address causing the VM exit. The VM-exit instruction length and VM-exit instruction information fields will be populated for these VM exits; see Table 2-6 for details.

**Table 2-6. Format of the VM-Exit Instruction Information Field Used for URDMSR and UWRMSR**

Bit Position	Content
2:0	Undefined.
6:3	Reg1: (ModR/M field, source / dest data operand) 0 = RAX / 1 = RCX / 2 = RDX / 3 = RBX / 4 = RSP / 5 = RBP / 6 = RSI / 7 = RDI. 8-15 represent R8-R15, respectively.
31:7	Undefined.

No new VMX execution controls are added for URDMSR; legacy MSR controls suffice. Legacy VMMs should not allow guests to set IA32\_USER\_MSR\_CTL.ENABLE and thus should not receive these VM exits.

### Operation

DEST := MSR[SRC]

### Flags Affected

None.

### Protected Mode Exceptions

#UD The URDMSR instruction is not recognized outside 64-bit mode.

### Real-Address Mode Exceptions

#UD The URDMSR instruction is not recognized outside 64-bit mode.

### Virtual-8086 Mode Exceptions

#UD The URDMSR instruction is not recognized outside 64-bit mode.

### Compatibility Mode Exceptions

#UD The URDMSR instruction is not recognized outside 64-bit mode.

### 64-Bit Mode Exceptions

#GP(0) If MSR\_address[63:14] is not all zero.  
If the MSR address is in the range 0–3FFH and bit n in the URDMSR bitmap is 0, where n is the MSR address.  
If a standalone RDMSR to the specified MSR would result in a #GP(0) exception due to the MSR not being accessible.  
If executed inside an enclave and URDMSR would cause a VM exit as defined in the section titled “Virtualization Behavior.”

#UD If the LOCK prefix is used.  
If CPUID.(EAX=07H, ECX=1):EDX.USER\_MSR[bit 15] = 0.  
If IA32\_USER\_MSR\_CTL.ENABLE = 0.

## UWRMSR—User Write to Model-Specific Register

Opcode / Instruction	Op/En	64/32 bit Mode Support	CPUID Feature Flag	Description
F30F 38 F8 11:rrr:bbb UWRMSR r64, r64	RM	V/N.E.	USER_MSR	Load into the MSR with address in rrr the value of register bbb.
VEX.128.F3.MAP7:W0.F8 11:000:bbb UWRMSR imm32, r64	IM	V/N.E.	USER_MSR	Load into the MSR with address in the 32-bit immediate the value of register bbb.

### Instruction Operand Encoding

Op/En	Operand 1	Operand 2	Operand 3	Operand 4
RM	ModRM:reg (r, w)	ModRM:r/m (r)	N/A	N/A
IM	imm32	ModRM:r/m (r)	N/A	N/A

### Description

UWRMSR writes the contents of operand 2 into the 64-bit MSR specified in operand 1. Operand 2 is a general-purpose register, while operand 1 may be either a general-purpose register or an immediate. UWRMSR writes the indicated MSR in the same manner as WRMSR, but it is limited to a specific set of MSRs. Table 2-7 gives the list of MSRs currently writeable by UWRMSR.

**Table 2-7. MSRs Writeable by UWRMSR**

MSR Name	MSR Address	Enumeration
IA32_UINTR_TIMER	1B00H	CPUID.07H.1.EDX[bit 13] (Processor supports User Timer feature)
IA32_UARCH_MISC_CTL	1B01H	IA32_ARCH_CAPABILITIES[bit 12] (Processor supports DOITM)

The MSRs enumerated in Table 2-7 can be written by UWRMSR at any privilege level but under OS control. The OS controls what MSRs can be read by the URDMSR and UWRMSR instructions with a 4-KByte bitmap located at an aligned linear address in the IA32\_USER\_MSR\_CTL (MSR address 1CH). The UWRMSR instruction is enabled only if bit 0 of this MSR is 1.

The high 2 KBytes of the bitmap control UWRMSR (they compose the UWRMSR bitmap); the 2 KBytes includes one bit for each MSR address in the range 0H–3FFFH. UWRMSR may write to an MSR only if the bit corresponding to the MSR has value 1; otherwise (or if the MSR address is outside that range) UWRMSR causes a general-protection exception (#GP).

UWRMSR accesses to these bitmaps are implicit supervisor-mode accesses, which means they use supervisor privilege regardless of CPL. The OS can create an alias to the bitmap in the user address space if it wants the application to know which MSRs are permitted. Still, the alias should be mapped read-only to prevent the application from overwriting the bitmap. UWRMSR behaves like WRMSRNS and is not defined as a serializing instruction (see “Serializing Instructions” in Chapter 9 of the Intel® 64 and IA-32 Architectures Software Developer’s Manual, Volume 3A). Refer to the WRMSRNS instruction for a thorough explanation of what this implies.

### Virtualization Behavior

Like WRMSR, execution of UWRMSR in VMX non-root operation causes a VM exit if any of the following are true:

- The “use MSR bitmaps” VM-execution control is 0.
- The value of the MSR address is not in the range 00000000H–00001FFFH.
- The value of the MSR address is in the range 00000000H–00001FFFH, and bit n in the write bitmap for low MSRs is 1, where n is the value of the MSR address.

Such VM exits have priority below a #GP due to an MSR address outside the bitmap range or whose bit is clear in the bitmap. In enclave mode, UWRMSR will cause a #GP(0) exception instead of a VM exit if any of the above conditions are true.

A VM exit for the above reasons for the UWRMSR instruction will specify exit reason 81 (decimal). The exit qualification is set to the MSR address causing the VM exit. The VM-exit instruction length and VM-exit instruction information fields will be populated for these VM exits. See Table 2-6, found under the URDMSR instruction, for details. No new VMX execution controls are added for UWRMSR; legacy MSR controls suffice. Legacy VMMs should not allow guests to set IA32\_USER\_MSR\_CTL.ENABLE and thus should not receive these VM exits.

### Operation

MSR[DEST] := SRC

### Flags Affected

None.

### Protected Mode Exceptions

#UD The UWRMSR instruction is not recognized outside 64-bit mode.

### Real-Address Mode Exceptions

#UD The UWRMSR instruction is not recognized outside 64-bit mode.

### Virtual-8086 Mode Exceptions

#UD The UWRMSR instruction is not recognized outside 64-bit mode.

### Compatibility Mode Exceptions

#UD The UWRMSR instruction is not recognized outside 64-bit mode.

### 64-Bit Mode Exceptions

#GP(0) If MSR\_address[63:14] is not all zero.  
 If the MSR address is in the range 0–3FFH and bit n in UWRMSR bitmap is 0, where n is the MSR address.  
 If the specified MSR is not listed in Table 2-7, “MSRs Writeable by UWRMSR.”  
 If WRMSR to the specified MSR would result in a #GP(0) exception due to the MSR not being accessible or attempting to set bits that are reserved.  
 If executed inside an enclave and UWRMSR would cause a VM exit as defined in the section titled “Virtualization Behavior.”

#UD If the LOCK prefix is used.  
 If CPUID.(EAX=07H, ECX=1):EDX.USER\_MSR[bit 15] = 0.  
 If IA32\_USER\_MSR\_CTL.ENABLE = 0.

## VSM4KEY4—Perform Four Rounds of SM4 Key Expansion

Opcode/ Instruction	Op/ En	64/32 bit Mode Support	CPUID Feature Flag	Description
VEX.128.F3.0F38.W0 DA /r VSM4KEY4 xmm1, xmm2, xmm3/m128	A	V/V	AVX AND SM4	Performs four rounds of SM4 key expansion.
VEX.256.F3.0F38.W0 DA /r VSM4KEY4 ymm1, ymm2, ymm3/m256	A	V/V	AVX AND SM4	Performs four rounds of SM4 key expansion.
EVEX.128.F3.0F38.W0 DA /r VSM4KEY4 xmm1, xmm2, xmm3/m128	B	V/V	AVX10.2 AND SM4	Performs four rounds of SM4 key expansion.
EVEX.256.F3.0F38.W0 DA /r VSM4KEY4 ymm1, ymm2, ymm3/m256	B	V/V	AVX10.2 AND SM4	Performs four rounds of SM4 key expansion.
EVEX.512.F3.0F38.W0 DA /r VSM4KEY4 zmm1, zmm2, zmm3/m512	B	V/V	AVX10.2 AND SM4	Performs four rounds of SM4 key expansion.

### Instruction Operand Encoding

Op/En	Tuple Type	Operand 1	Operand 2	Operand 3	Operand 4
A	N/A	ModRM:reg (w)	VEX.vvvv (r)	ModRM:r/m (r)	N/A
B	FULLMEM	ModRM:reg (w)	EVEX.vvvv (r)	ModRM:r/m (r)	N/A

### Description

The VSM4KEY4 instruction performs four rounds of SM4 key expansion. The instruction operates on independent 128-bit lanes.

Additional details can be found at: <https://tools.ietf.org/html/draft-ribose-cfrg-sm4-10>.

Both SM4 instructions use a common sbox table:

```

BYTE sbox[256] = {
0xD6, 0x90, 0xE9, 0xFE, 0xCC, 0xE1, 0x3D, 0xB7, 0x16, 0xB6, 0x14, 0xC2, 0x28, 0xFB, 0x2C, 0x05,
0x2B, 0x67, 0x9A, 0x76, 0x2A, 0xBE, 0x04, 0xC3, 0xAA, 0x44, 0x13, 0x26, 0x49, 0x86, 0x06, 0x99,
0x9C, 0x42, 0x50, 0xF4, 0x91, 0xEF, 0x98, 0x7A, 0x33, 0x54, 0x0B, 0x43, 0xED, 0xCF, 0xAC, 0x62,
0xE4, 0xB3, 0x1C, 0xA9, 0xC9, 0x08, 0xE8, 0x95, 0x80, 0xDF, 0x94, 0xFA, 0x75, 0x8F, 0x3F, 0xA6,
0x47, 0x07, 0xA7, 0xFC, 0xF3, 0x73, 0x17, 0xBA, 0x83, 0x59, 0x3C, 0x19, 0xE6, 0x85, 0x4F, 0xA8,
0x68, 0x6B, 0x81, 0xB2, 0x71, 0x64, 0xDA, 0x8B, 0xF8, 0xEB, 0x0F, 0x4B, 0x70, 0x56, 0x9D, 0x35,
0x1E, 0x24, 0x0E, 0x5E, 0x63, 0x58, 0xD1, 0xA2, 0x25, 0x22, 0x7C, 0x3B, 0x01, 0x21, 0x78, 0x87,
0xD4, 0x00, 0x46, 0x57, 0x9F, 0xD3, 0x27, 0x52, 0x4C, 0x36, 0x02, 0xE7, 0xA0, 0xC4, 0xC8, 0x9E,
0xEA, 0xBF, 0x8A, 0xD2, 0x40, 0xC7, 0x38, 0xB5, 0xA3, 0xF7, 0xF2, 0xCE, 0xF9, 0x61, 0x15, 0xA1,
0xE0, 0xAE, 0x5D, 0xA4, 0x9B, 0x34, 0x1A, 0x55, 0xAD, 0x93, 0x32, 0x30, 0xF5, 0x8C, 0xB1, 0xE3,
0x1D, 0xF6, 0xE2, 0x2E, 0x82, 0x66, 0xCA, 0x60, 0xC0, 0x29, 0x23, 0xAB, 0x0D, 0x53, 0x4E, 0x6F,
0xD5, 0xDB, 0x37, 0x45, 0xDE, 0xFD, 0x8E, 0x2F, 0x03, 0xFF, 0x6A, 0x72, 0x6D, 0x6C, 0x5B, 0x51,
0x8D, 0x1B, 0xAF, 0x92, 0xBB, 0xDD, 0xBC, 0x7F, 0x11, 0xD9, 0x5C, 0x41, 0x1F, 0x10, 0x5A, 0xD8,
0x0A, 0xC1, 0x31, 0x88, 0xA5, 0xCD, 0x7B, 0xBD, 0x2D, 0x74, 0xD0, 0x12, 0xB8, 0xE5, 0xB4, 0xB0,
0x89, 0x69, 0x97, 0x4A, 0x0C, 0x96, 0x77, 0x7E, 0x65, 0xB9, 0xF1, 0x09, 0xC5, 0x6E, 0xC6, 0x84,
0x18, 0xF0, 0x7D, 0xEC, 0x3A, 0xDC, 0x4D, 0x20, 0x79, 0xEE, 0x5F, 0x3E, 0xD7, 0xCB, 0x39, 0x48
}

```



## Operation

```

define ROL32(dword, n):
    count := n % 32
    dest := (dword << count) | (dword >> (32-count))
    return dest

define SBOX_BYTE(dword, i):
    // sbox[] array defined in introduction
    return sbox[dword.byte[i]]

define lower_t(dword):
    tmp.byte[0] := SBOX_BYTE(dword, 0)
    tmp.byte[1] := SBOX_BYTE(dword, 1)
    tmp.byte[2] := SBOX_BYTE(dword, 2)
    tmp.byte[3] := SBOX_BYTE(dword, 3)
    return tmp

define L_KEY(dword):
    return dword ^ ROL32(dword, 13) ^ ROL32(dword, 23)

define T_KEY(dword):
    return L_KEY(lower_t(dword))

define F_KEY(X0, X1, X2, X3, round_key):
    return X0 ^ T_KEY(X1 ^ X2 ^ X3 ^ round_key)

```

## VSM4KEY4 DEST, SRC1, SRC2

```

VL = (128, 256) // VEX versions
// or
VL = (128, 256, 512) // EVEX versions
KL := VL/128

```

```

for i in 0..KL-1:
    P[0] := SRC1.xmm[i].dword[0]
    P[1] := SRC1.xmm[i].dword[1]
    P[2] := SRC1.xmm[i].dword[2]
    P[3] := SRC1.xmm[i].dword[3]

    C[0] := F_KEY(P[0], P[1], P[2], P[3], SRC2.xmm[i].dword[0])
    C[1] := F_KEY(P[1], P[2], P[3], C[0], SRC2.xmm[i].dword[1])
    C[2] := F_KEY(P[2], P[3], C[0], C[1], SRC2.xmm[i].dword[2])
    C[3] := F_KEY(P[3], C[0], C[1], C[2], SRC2.xmm[i].dword[3])

    DEST.xmm[i].dword[0] := C[0]
    DEST.xmm[i].dword[1] := C[1]
    DEST.xmm[i].dword[2] := C[2]
    DEST.xmm[i].dword[3] := C[3]

```

```
DEST[MAXVL-1:VL] := 0
```

## Flags Affected

None.

### **SIMD Floating-Point Exceptions**

None.

### **Other Exceptions**

VEX-encoded instructions, see Exceptions Type 6 in the Intel® 64 and IA-32 Architectures Software Developer's Manual, Volume 2A.

EVEX-encoded instructions, see Exceptions Type E6 in the Intel® 64 and IA-32 Architectures Software Developer's Manual, Volume 2A.

**VSM4RND\$4—Performs Four Rounds of SM4 Encryption**

Opcode/ Instruction	Op/ En	64/32 bit Mode Support	CPUID Feature Flag	Description
VEX.128.F2.0F38.W0 DA /r VSM4RND\$4 xmm1, xmm2, xmm3/m128	A	V/V	AVX AND SM4	Performs four rounds of SM4 encryption.
VEX.256.F2.0F38.W0 DA /r VSM4RND\$4 ymm1, ymm2, ymm3/m256	A	V/V	AVX AND SM4	Performs four rounds of SM4 encryption.
EVEX.128.F2.0F38.W0 DA /r VSM4RND\$4 xmm1, xmm2, xmm3/m128	B	V/V	AVX10.2 AND SM4	Performs four rounds of SM4 encryption.
EVEX.256.F2.0F38.W0 DA /r VSM4RND\$4 ymm1, ymm2, ymm3/m256	B	V/V	AVX10.2 AND SM4	Performs four rounds of SM4 encryption.
EVEX.512.F2.0F38.W0 DA /r VSM4RND\$4 zmm1, zmm2, zmm3/m512	B	V/V	AVX10.2 AND SM4	Performs four rounds of SM4 encryption.

**Instruction Operand Encoding**

Op/En	Tuple Type	Operand 1	Operand 2	Operand 3	Operand 4
A	N/A	ModRM:reg (w)	VEX.vvvv (r)	ModRM:r/m (r)	N/A
B	FULLMEM	ModRM:reg (w)	EVEX.vvvv (r)	ModRM:r/m (r)	N/A

**Description**

The SM4RND\$4 instruction performs four rounds of SM4 encryption. The instruction operates on independent 128-bit lanes.

Additional details can be found at: <https://tools.ietf.org/html/draft-ribose-cfrg-sm4-10>.

See “VSM4KEY4—Perform Four Rounds of SM4 Key Expansion” for the sbox table.

**Operation**

// see the VSM4KEY4 instruction for the definition of ROL32, lower\_t

```
define L_RND(dword):
    tmp := dword
    tmp := tmp ^ ROL32(dword, 2)
    tmp := tmp ^ ROL32(dword, 10)
    tmp := tmp ^ ROL32(dword, 18)
    tmp := tmp ^ ROL32(dword, 24)
    return tmp

define T_RND(dword):
    return L_RND(lower_t(dword))

define F_RND(X0, X1, X2, X3, round_key):
    return X0 ^ T_RND(X1 ^ X2 ^ X3 ^ round_key)
```

**VSM4RND\$4 DEST, SRC1, SRC2**

```

VL = (128, 256) // VEX versions
//or
VL = (128, 256, 512) // EVEX versions
KL := VL/128

```

```

for i in 0..KL-1:
  P[0] := SRC1.xmm[i].dword[0]
  P[1] := SRC1.xmm[i].dword[1]
  P[2] := SRC1.xmm[i].dword[2]
  P[3] := SRC1.xmm[i].dword[3]

  C[0] := F_RND(P[0], P[1], P[2], P[3], SRC2.xmm[i].dword[0])
  C[1] := F_RND(P[1], P[2], P[3], C[0], SRC2.xmm[i].dword[1])
  C[2] := F_RND(P[2], P[3], C[0], C[1], SRC2.xmm[i].dword[2])
  C[3] := F_RND(P[3], C[0], C[1], C[2], SRC2.xmm[i].dword[3])

  DEST.xmm[i].dword[0] := C[0]
  DEST.xmm[i].dword[1] := C[1]
  DEST.xmm[i].dword[2] := C[2]
  DEST.xmm[i].dword[3] := C[3]

```

```
DEST[MAXVL-1:VL] := 0
```

### Flags Affected

None.

### SIMD Floating-Point Exceptions

None.

### Other Exceptions

VEX-encoded instructions, see Exceptions Type 6 in the Intel® 64 and IA-32 Architectures Software Developer's Manual, Volume 2A.

EVEX-encoded instructions, see Exceptions Type E6 in the Intel® 64 and IA-32 Architectures Software Developer's Manual, Volume 2A.

## WRMSRNS—Non-Serializing Write to Model Specific Register

Opcode/ Instruction	Op/ En	64/32 Bit Mode Support	CPUID Feature Flag	Description
NP OF 01 C6 WRMSRNS	Z0	V/V	WRMSRNS	Write the value in EDX:EAX to MSR specified by ECX.
VEX.128.F3.MAP7:W0.F6 11:000:bbb WRMSRNS imm32, r64	IM	V/N.E.	MSR_IMM	Write the value of register bbb to the MSR specified in the 32-bit immediate.
EVEX.128.F3.MAP7:W0.F6 11:000:bbb WRMSRNS imm32, r64	IM	V/N.E.	APX_F <sup>1</sup> AND MSR_IMM	Write the value of register bbb to the MSR specified in the 32-bit immediate.

### NOTES:

- For more information on the Intel® APX instruction format, see the Intel® Advanced Performance Extensions Architecture Specification.

### Instruction Operand Encoding

Op/En	Operand 1	Operand 2	Operand 3	Operand 4
Z0	N/A	N/A	N/A	N/A
IM	imm32	ModRM:r/m (r)	N/A	N/A

### Description

WRMSRNS is an instruction that behaves like WRMSR, except that it is not a serializing instruction by default. It can be executed only at privilege level 0 or in real-address mode; otherwise, a general protection exception #GP(0) is generated. WRMSRNS has an **implicit** form and an **immediate** form.

The implicit form writes the contents of registers EDX:EAX into the 64-bit model specific register (MSR) specified in the ECX register. The contents of the EDX register are copied to the high-order 32 bits of the selected MSR and the contents of the EAX register are copied to the low-order 32 bits of the MSR. The high-order 32 bits of RAX, RCX, and RDX are ignored.

The immediate form writes the contents of operand 2 into the 64-bit MSR specified by operand 1. Operand 2 is a general-purpose register, while operand 1 is an immediate. The immediate form can be used only in 64-bit mode; otherwise, a invalid-opcode exception (#UD) will be generated.

Unlike WRMSR, WRMSRNS is not defined as a serializing instruction (see “Serializing Instructions” in Chapter 9 of the Intel® 64 and IA-32 Architectures Software Developer’s Manual, Volume 3A). This means that software should not rely on it to drain all buffered writes to memory before the next instruction is fetched and executed. For implementation reasons, some processors may serialize when writing certain MSRs, even though that is not guaranteed.

Like WRMSR, WRMSRNS will ensure that all operations before it do not use the new MSR value and that all operations after the WRMSRNS do use the new value. An exception to this rule is certain store related performance monitor events that only count when those stores are drained to memory. Since WRMSRNS is not a serializing instruction, if software is using WRMSRNS to change the controls for such performance monitor events, then stores before the WRMSRNS may be counted with new MSR values written by WRMSRNS. Software can insert the SERIALIZE instruction before the WRMSRNS if so desired.

MSRs that cause a TLB invalidation when written via WRMSR (e.g., MTRRs) will also cause the same TLB invalidation when written by WRMSRNS.

In order to improve performance, software may replace WRMSR with WRMSRNS. In places where WRMSR is being used as a proxy for a serializing instruction, a different serializing instruction can be used (e.g., SERIALIZE).

### Operation

IF implicit form

THEN

MSR[ECX] := EDX:EAX;

ELSE (\* immediate form \*)  
MSR[DEST] := SRC;

### Flags Affected

None.

### Protected Mode Exceptions

- #GP(0) If the current privilege level is not 0.  
If the specified MSR address is reserved or unimplemented MSR.  
If the source data sets bits that are reserved in the specified MSR.  
If the source data contains a non-canonical address and the specified MSR is one of the following: IA32\_BNDCFGS, IA32\_DS\_AREA, IA32\_FS\_BASE, IA32\_GS\_BASE, IA32\_INTERRUPT\_SSP\_TABLE\_ADDR, IA32\_KERNEL\_GS\_BASE, IA32\_LSTAR, IA32\_PL0\_SSP, IA32\_PL1\_SSP, IA32\_PL2\_SSP, IA32\_PL3\_SSP, IA32\_RTIT\_ADDR0\_A, IA32\_RTIT\_ADDR0\_B, IA32\_RTIT\_ADDR1\_A, IA32\_RTIT\_ADDR1\_B, IA32\_RTIT\_ADDR2\_A, IA32\_RTIT\_ADDR2\_B, IA32\_RTIT\_ADDR3\_A, IA32\_RTIT\_ADDR3\_B, IA32\_S\_CET, IA32\_SYSENTER\_EIP, IA32\_SYSENTER\_ESP, IA32\_UINTR\_HANDLER, IA32\_UINTR\_PD, IA32\_UINTR\_STACKADJUST, IA32\_U\_CET, and IA32\_UINTR\_TT.
- #UD If the LOCK prefix is used.  
If the immediate form is used.

### Real-Address Mode Exceptions

- #GP(0) If the specified MSR address is reserved or unimplemented MSR.  
If the source data sets bits that are reserved in the specified MSR.  
If the source data contains a non-canonical address and the specified MSR is one of the following: IA32\_BNDCFGS, IA32\_DS\_AREA, IA32\_FS\_BASE, IA32\_GS\_BASE, IA32\_INTERRUPT\_SSP\_TABLE\_ADDR, IA32\_KERNEL\_GS\_BASE, IA32\_LSTAR, IA32\_PL0\_SSP, IA32\_PL1\_SSP, IA32\_PL2\_SSP, IA32\_PL3\_SSP, IA32\_RTIT\_ADDR0\_A, IA32\_RTIT\_ADDR0\_B, IA32\_RTIT\_ADDR1\_A, IA32\_RTIT\_ADDR1\_B, IA32\_RTIT\_ADDR2\_A, IA32\_RTIT\_ADDR2\_B, IA32\_RTIT\_ADDR3\_A, IA32\_RTIT\_ADDR3\_B, IA32\_S\_CET, IA32\_SYSENTER\_EIP, IA32\_SYSENTER\_ESP, IA32\_UINTR\_HANDLER, IA32\_UINTR\_PD, IA32\_UINTR\_STACKADJUST, IA32\_U\_CET, and IA32\_UINTR\_TT.
- #UD If the LOCK prefix is used.  
If the immediate form is used.

### Virtual-8086 Mode Exceptions

- #GP(0) For the implicit form: the WRMSRNS instruction is not recognized in virtual-8086 mode.  
#UD For the immediate form: the WRMSRNS instruction is not recognized in virtual-8086 mode.

### Compatibility Mode Exceptions

Same exceptions as in protected mode.

### 64-Bit Mode Exceptions

- #GP(0) If the current privilege level is not 0.  
If the specified MSR address is reserved or unimplemented MSR.  
If the source data sets bits that are reserved in the specified MSR.  
If the source data contains a non-canonical address and the specified MSR is one of the following: IA32\_BNDCFGS, IA32\_DS\_AREA, IA32\_FS\_BASE, IA32\_GS\_BASE, IA32\_INTERRUPT\_SSP\_TABLE\_ADDR, IA32\_KERNEL\_GS\_BASE, IA32\_LSTAR, IA32\_PL0\_SSP, IA32\_PL1\_SSP, IA32\_PL2\_SSP, IA32\_PL3\_SSP, IA32\_RTIT\_ADDR0\_A, IA32\_RTIT\_ADDR0\_B, IA32\_RTIT\_ADDR1\_A, IA32\_RTIT\_ADDR1\_B, IA32\_RTIT\_ADDR2\_A,



IA32\_RTIT\_ADDR2\_B, IA32\_RTIT\_ADDR3\_A, IA32\_RTIT\_ADDR3\_B, IA32\_S\_CET,  
IA32\_SYSENTER\_EIP, IA32\_SYSENTER\_ESP, IA32\_UINTR\_HANDLER, IA32\_UINTR\_PD,  
IA32\_UINTR\_STACKADJUST, IA32\_U\_CET, and IA32\_UINTR\_TT.

#UD

If the LOCK prefix is used.

If the immediate form is used and CPUID.(EAX=07H, ECX=01H):ECX.MSR\_IMM[bit 5] = 0.

## NOTES

The following Intel® AMX instructions have moved to the Intel® 64 and IA-32 Architectures Software Developer's Manual: LDTILECFG, STTILECFG, TDPBF16PS, TDPBSSD/TDPBSUD/TDPBUSD/TDPBUUD, TDPFP16PS, TILELOADD/TILELOADDT1, TILERELASE, TILESTORED, and TILEZERO.

The Intel Advanced Matrix Extensions introductory material and helper functions will be maintained here, as well as in the Intel® 64 and IA-32 Architectures Software Developer's Manual, for the reader's convenience. For information on Intel AMX and the XSAVE feature set, and recommendations for system software, see the latest version of the Intel® 64 and IA-32 Architectures Software Developer's Manual.

### 3.1 INTRODUCTION

Intel® Advanced Matrix Extensions (Intel® AMX) is a new 64-bit programming paradigm consisting of two components: a set of 2-dimensional registers (tiles) representing sub-arrays from a larger 2-dimensional memory image, and an accelerator able to operate on tiles, the first implementation is called TMUL (tile matrix multiply unit).

An Intel AMX implementation enumerates to the programmer how the tiles can be programmed by providing a palette of options. Two palettes are supported; palette 0 represents the initialized state, and palette 1 consists of 8 KB of storage spread across 8 tile registers named TMM0..TMM7. Each tile has a maximum size of 16 rows x 64 bytes, (1 KB), however the programmer can configure each tile to smaller dimensions appropriate to their algorithm. The tile dimensions supplied by the programmer (rows and bytes\_per\_row, i.e., **colsb**) are metadata that drives the execution of tile and accelerator instructions. In this way, a single instruction can launch autonomous multi-cycle execution in the tile and accelerator hardware. The palette value (**palette\_id**) and metadata are held internally in a tile related control register (TILECFG). The TILECFG contents will be commensurate with that reported in the palette\_table (see "CPUID—CPU Identification" in Chapter 1 for a description of the available parameters).

Intel AMX is an extensible architecture. New accelerators can be added, or the TMUL accelerator may be enhanced to provide higher performance. In these cases, the state (TILEDATA) provided by tiles may need to be made larger, either in one of the metadata dimensions (more rows or colsb) and/or by supporting more tile registers (names). The extensibility is carried out by adding new palette entries describing the additional state. Since execution is driven through metadata, an existing Intel AMX binary could take advantage of larger storage sizes and higher performance TMUL units by selecting the most powerful palette indicated by CPUID and adjusting loop and pointer updates accordingly.

Figure 3-1 shows a conceptual diagram of the Intel AMX architecture. An Intel architecture host drives the algorithm, the memory blocking, loop indices and pointer arithmetic. Tile loads and stores and accelerator commands are sent to multi-cycle execution units. Status, if required, is reported back. Intel AMX instructions are synchronous in the Intel architecture instruction stream and the memory loaded and stored by the tile instructions is coherent with respect to the host's memory accesses. There are no restrictions on interleaving of Intel architecture and Intel AMX code or restrictions on the resources the host can use in parallel with Intel AMX (e.g., Intel AVX-512). There is also no architectural requirement on the Intel architecture compute capability of the Intel architecture host other than it supports 64-bit mode.



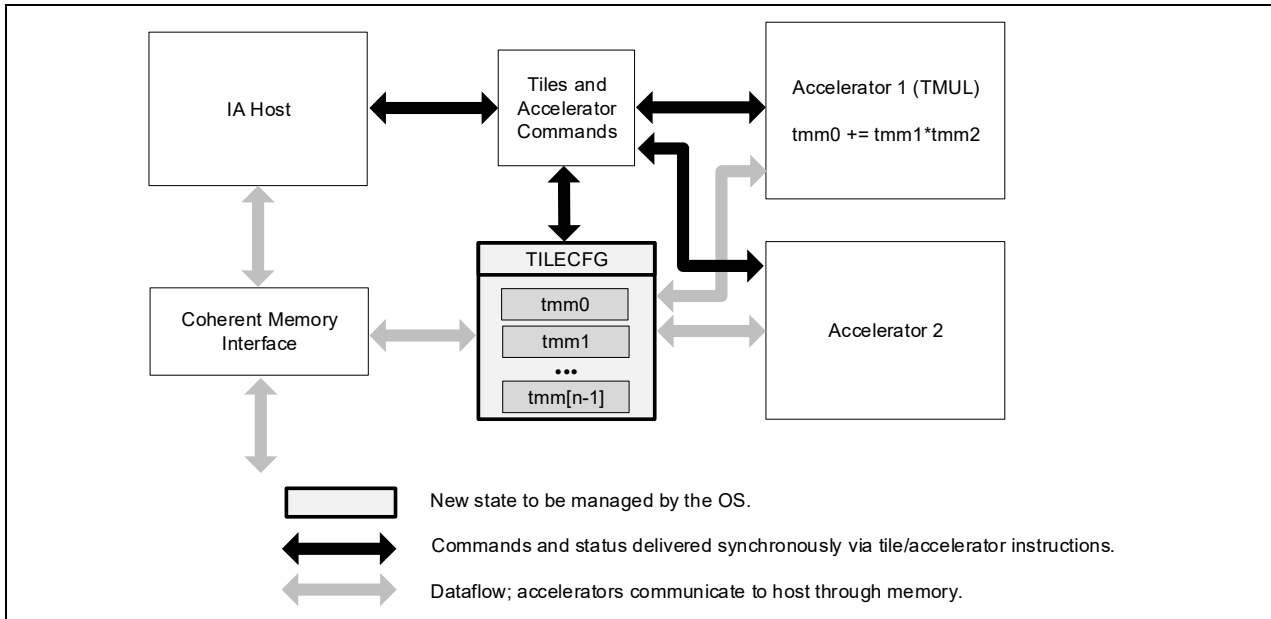

Figure 3-1. Intel® AMX Architecture

Intel AMX instructions use new registers and inherit basic behavior from Intel architecture in the same manner that Intel SSE and Intel AVX did. Tile instructions include loads and stores using the traditional Intel architecture register set as pointers. The TMUL instruction set (defined to be CPUID bits AMX-BF16 and AMX-INT8) only supports reg-reg operations.

TILECFG is programmed using the LDTILECFG instruction. The selected palette defines the available storage and general configuration while the rest of the memory data specifies the number of rows and column bytes for each tile. Consistency checks are performed to ensure the TILECFG matches the restrictions of the palette. A General Protection fault (#GP) is reported if the LDTILECFG fails consistency checks. A successful load of TILECFG with a palette\_id other than 0 is represented in this document with TILES\_CONFIGURED = 1. When the TILECFG is initialized (palette\_id = 0), it is represented in the document as TILES\_CONFIGURED = 0. Nearly all Intel AMX instructions will generate a #UD exception if TILES\_CONFIGURED is not equal to 1; the exceptions are those that do TILECFG maintenance: LDTILECFG, STTILECFG and TILERELASE.

If a tile is configured to contain M rows by N column bytes, LDTILECFG will ensure that the metadata values are appropriate to the palette (e.g., that  $M \leq 16$  and  $N \leq 64$  for palette 1). The four M and N values can all be different as long as they adhere to the restrictions of the palette. Further dynamic checks are done in the tile and the TMUL instruction set to deal with cases where a legally configured tile may be inappropriate for the instruction operation. Tile registers can be set to 'invalid' by configuring the rows and colsb to '0'.

Tile loads and stores are strided accesses from the application memory to packed rows of data. Algorithms are expressed assuming row major data layout. Column major users should translate the terms according to their orientation.

TILELOAD\* and TILESTORE\* instructions are restartable and can handle (up to)  $2 \times$  rows page faults per instruction. Restartability is provided by a **start\_row** parameter in the TILECFG register.

The TMUL unit is conceptually a grid of fused multiply-add units able to read and write tiles. The dimensions of the TMUL unit (tmul\_maxk and tmul\_maxn) are enumerated similar to the maximum dimensions of the tiles (see "CPUID—CPU Identification" in Chapter 1 for details).

The matrix multiplications in the TMUL instruction set compute  $C[M][N] += A[M][K] * B[K][N]$ . The M, N, and K values will cause the TMUL instruction set to generate a #UD exception if the dimensions do not match for matrix multiply or do not match the palette.

In Figure 3-2, the number of rows in tile B matches the K dimension in the matrix multiplication pseudocode. K dimensions smaller than that enumerated in the TMUL grid are also possible and any additional computation the TMUL unit can support will not affect the result.

The number of elements specified by colsb of the B matrix is also less than or equal to tmul\_maxn. Any remaining values beyond that specified by the metadata will be set to zero.

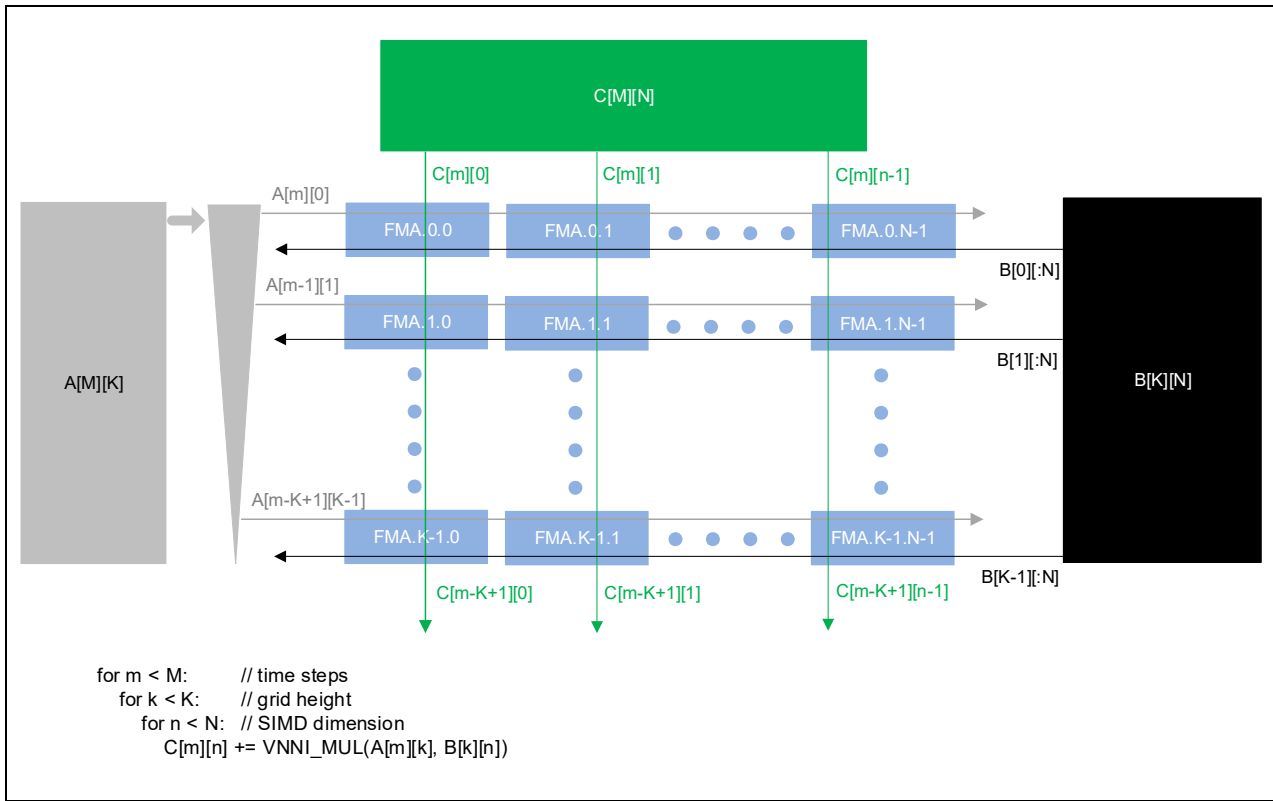

Figure 3-2. The TMUL Unit

The XSAVE feature sets supports context management of the new state defined for Intel AMX. This support is described in Section 3.2.

### 3.1.1 Tile Architecture Details

The supported parameters for the tile architecture are reported via CPUID; this includes information about how the number of tile registers (max\_names) can be configured (the palette). Configuring the tile architecture is intended to be done once when entering a region of tile code using the LDTILECFG instruction specifying the selected palette and describing in detail the configuration for each tile. Incorrect assignments will result in a General Protection fault (#GP). Successful LDTILECFG initializes (zeroes) TILEDATA.

Exiting a tile region is done with the TILERELLEASE instruction. It takes no parameters and invalidates all tiles (indicating that the data no longer needs any saving or restoring). Essentially, it is an optimization of LDTILECFG with an implicit palette of 0.

For applications that execute consecutive Intel AMX regions with differing configurations, TILERELLEASE is not required between them since the second LDTILECFG will clear all the data while loading the new configuration. There is no instruction set support for automatic nesting of tile regions, though with sufficient effort software can accomplish this by saving and restoring TILEDATA and TILECFG either through the XSAVE architecture or the Intel AMX instructions.

The tile architecture boots in its INIT state, with TILECFG and TILEDATA set to zero. A successfully executing LDTILECFG instruction to a non-zero palette sets the TILES\_CONFIGURED=1, indicating the TILECFG is not in the INIT state. The TILERELLEASE instruction sets TILES\_CONFIGURED = 0 and initializes (zeroes) TILEDATA.

To facilitate handling of tile configuration data, there is a STTILECFG instruction. If the tile configuration is in the INIT state (`TILES_CONFIGURED == 0`), then STTILECFG will write 64 bytes of zeros. Otherwise STTILECFG will store the TILECFG to memory in the format used by LDTILECFG.

### 3.1.2 TMUL Architecture Details

The supported parameters for the TMUL architecture are reported via CPUID; see “CPUID—CPU Identification” in Chapter 1, page 1-26, for details. These parameters include a maximum height (**`tmul_maxk`**) and a maximum SIMD dimension (**`tmul_maxn`**). The metadata that accompanies the `srcdst`, `src1` and `src2` tiles to the TMUL unit will be dynamically checked to see that they match the TMUL unit support for the data type and match the requirements of a meaningful matrix multiplication.

Figure 3-3 shows an example of the inner loop of an algorithm of using the TMUL architecture to compute a matrix multiplication. In this example, we use two result tiles, `tmm0` and `tmm1`, from matrix C to accumulate the intermediate results. One tile from the A matrix (`tmm2`) is re-used twice as we multiply it by two tiles from the B matrix. The algorithm then advances pointers to load a new A tile and two new B tiles from the directions indicated by the arrows. An outer loop, not shown, adjusts the pointers for the C tiles.

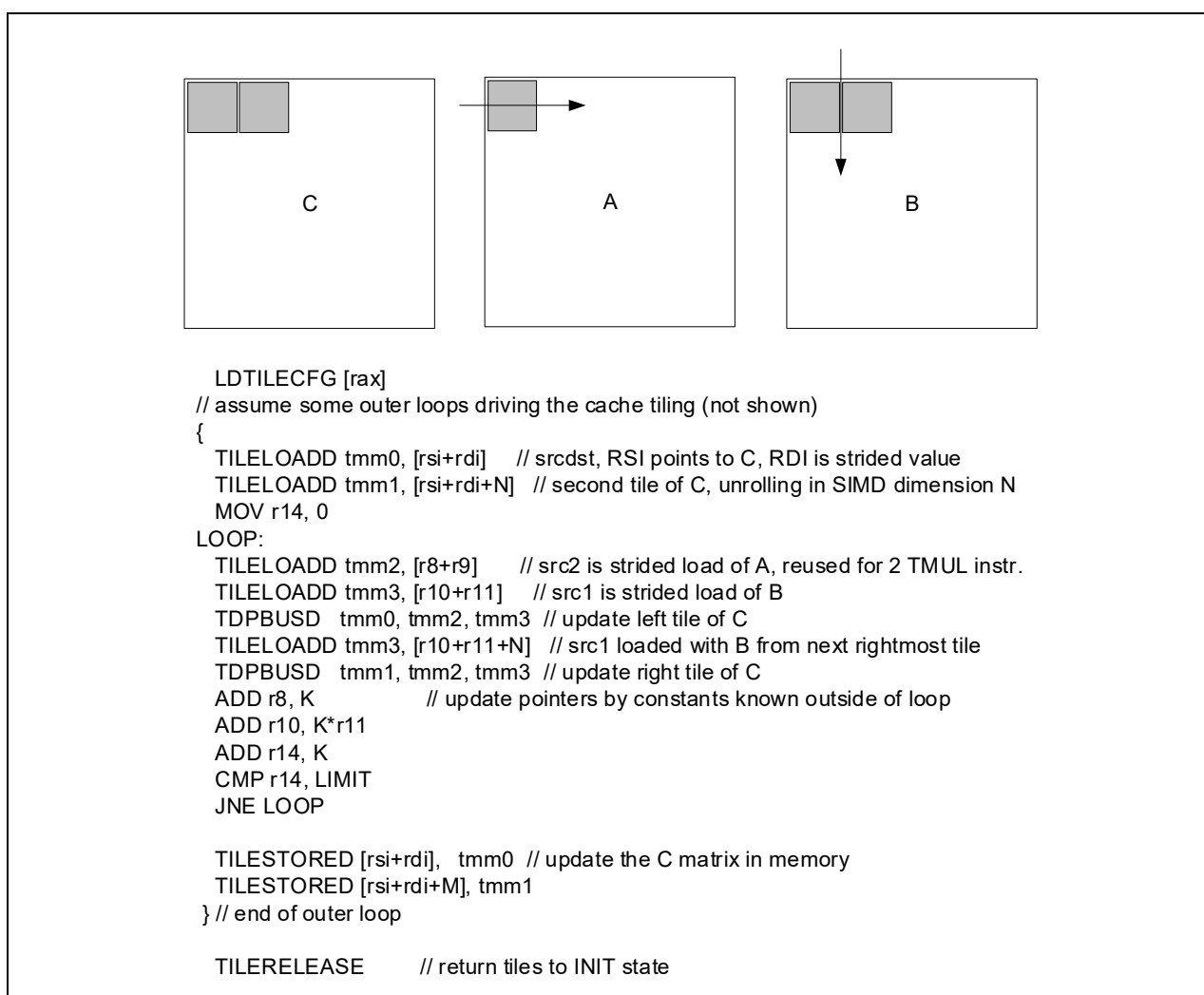

Figure 3-3. Matrix Multiply  $C += A * B$

### 3.1.3 Handling of Tile Row and Column Limits

Intel AMX operations will zero any rows and any columns beyond the dimensions specified by TILECFG. Tile operations will zero the data beyond the configured number of column bytes as each row is written. For example, with 64-byte rows and a tile configured with 10 rows and 48 columns, an operation writing dword elements would write each of the first 10 rows with 48 bytes of output/result data and zero the remaining 16 bytes in each row. Tile operations also fully zero any rows after the first 10 configured rows. When using a 1 KByte tile with 64-byte rows, there would be 16 rows, so in this example, the last 6 rows would also be zeroed.

Intel AMX instructions will always obey the metadata on reads and the zeroing rules on writes, and so a subsequent XSAVE would see zeros in the appropriate locations. Tiles that are not written by Intel AMX instructions between XRSTOR and XSAVE will write back with the same image they were loaded with regardless of the value of TILECFG.

### 3.1.4 Exceptions and Interrupts

Tile instructions are restartable so that operations that access strided memory can restart after page faults. To support restarting instructions after these events, the instructions store information in the **TILECFG.start\_row** register. TILECFG.start\_row indicates the row that should be used for restart; i.e., it indicates **next row after** the rows that have already been successfully loaded (on a TILELOAD) or written to memory (on a TILESTORE) and prevents repeating work that was successfully done.

The TMUL instruction set is not sensitive to the TILECFG.start\_row value; this is due to there not being TMUL instructions with memory operands or any restartable faults.

## 3.2 OPERAND RESTRICTIONS

Floating-point exceptions, denormal handling, and floating-point rounding: some of the Intel AMX instructions operate on floating-point values. These instructions all function as if floating-point exceptions are masked, and use the round-to-nearest-even (RNE) rounding mode. They also do not set any of the floating-point exception flags in MXCSR. Table 3-1 describes the treatment of denormal inputs and outputs for Intel AMX operations.

**Table 3-1. Intel® AMX Treatment of Denormal Inputs and Outputs**

Data Type	Denormal Input	Denormal Output
FP16	Allowed	N/A
FP32	Treated as zero	Flushed to zero
BF16	Treated as zero	N/A

## 3.3 IMPLEMENTATION PARAMETERS

The parameters are reported via CPUID leaf 1DH. Index 0 reports all zeros for all fields.

```
define palette_table[id]:
    uint16_t total_tile_bytes
    uint16_t bytes_per_tile
    uint16_t bytes_per_row
    uint16_t max_names
    uint16_t max_rows
```

The tile parameters are set by LDTILECFG or XRSTOR\* of TILECFG:

```
define tile[tid]:
    byte rows
    word colsb // bytes_per_row
    bool valid
```

## 3.4 HELPER FUNCTIONS

The helper functions used in Intel AMX instructions are defined below.

```
define write_row_and_zero(treg, r, data, nbytes):
    for j in 0 ...nbytes-1:
        treg.row[r].byte[j] := data.byte[j]

    // zero the rest of the row
    for j in nbytes ... palette_table[tilecfg.palette_id].bytes_per_row-1:
        treg.row[r].byte[j] := 0

define zero_upper_rows(treg, r):
    for i in r ... palette_table[tilecfg.palette_id].max_rows-1:
        for j in 0 ... palette_table[tilecfg.palette_id].bytes_per_row-1:
            treg.row[i].byte[j] := 0

define zero_out_of_range_columns(treg):
    for i in 0 ... palette_table[tilecfg.palette_id].max_rows-1:
        for j in treg.colsb ... palette_table[tilecfg.palette_id].bytes_per_row-1:
            treg.row[i].byte[j] := 0

define zero_tileconfig_start():
    tilecfg.start_row :=0

define zero_all_tile_data():
    if XCR0[TILEDATA]:
        b := CPUID(0xD,TILEDATA).EAX // size of feature
        for j in 0 ...b:
            TILEDATA.byte[j] := 0
```

```
define xcr0_supports_palette(palette_id):
    if palette_id == 0:
        return 1
    elif palette_id == 1:
        if XCR0[TILECFG] and XCR0[TILEDATA]:
            return 1
    return 0

define fma32(acc, x, y, daz, ftz, sae, rc):
    // sae = suppress all exceptions. if 1= no exceptions
    // are raised or denoted in mxcsr
    if daz and denormal(x):
        x = 0
    if daz and denormal(y):
        y = 0
    if daz and denormal(acc):
        acc = 0
    // traditional infinite precision fma
    // using sae and rounding control from rc
    v = (x*y) + acc
    if ftz and denormal(v):
        v = 0
    return v
```

```

define convert_int128_to_fp32( in, type1, type2 ):
    // int128 is an integer value
    // type1 and type2 can be HF8, BF8

    if (in == 0):
        return 0

    sign = in[127]
    magnitude[127:0] = sign ? -in : in          // get absolute value
    Jbit_position = 126
    while (magnitude[126]==0):
        Jbit_position-- // get Jbit index
        magnitude << 1 // normalize in to the left

    // Jbit index is 126
    // Lbit index is 126-23=103
    // Gbit index is then 102
    sticky = OR(magnitude[101:0]) // get sticky value
    Gbit = magnitude[102] // get Gbit
    Lbit = magnitude[103] // get Lbit
    RndAdd1 = Gbit & (Lbit | sticky) // RNE parameter

    Mantissa[24:0] = magnitude >> 103 // get mantissa[24:0] (Jbit in Mantissa[23])

    RndMantissa = Mantissa + RndAdd1

    Ovf = RndMantissa >> 24 // check if rounded mantissa overflow

    match (type1, type2): // get exponent factor
        case [BF8 BF8] : factor=32 // 2*16
        case [HF8 HF8] : factor=18 // 2*9
        case _ : factor=25 // 16+9

    // Destination exponent = BIAS+(Jbit_position+Ovf)-factor
    exp = 127 + Jbit_position - factor + Ovf // set destination exponent
    frac = RndMantissa & 0x7FFFFFFF // set destination fraction

    res = sign<<31 // set sign in bit[32]
    res |= exp << 23 // set exp in bits[30:23]
    res |= frac // get frac in bits[22:0]

    return res // get fp32 format, RNE

```

```

define convert_fp8_to_int64(x, type):
    // The x parameter is the data,
    //the type parameter is the data format indicating bfloat8 or hfloat8.
    if *type is bf8*:
        return convert_bf8_to_int64(x)
    else:
        return convert_hf8_to_int64(x)

define convert_fp32_to_bfloat16(x):
    IF x is zero or denormal:
        dest[15] := x[31] // sign preserving zero (denormal go to zero)
        dest[14:0] := 0
    ELSE IF x is infinity:
        dest[15:0] := x[31:16]
    ELSE IF x is nan:
        dest[15:0] := x[31:16] // truncate and set msb of the mantisa force qnan
        dest[6] := 1
    ELSE // normal number
        lsb := x[16]
        rounding_bias := 0x00007FFF + lsb
        temp[31:0] := x[31:0] + rounding_bias // integer add
        dest[15:0] := temp[31:16]
return dest

define convert_bf8_to_int64( in ):
    // BF8 = E5M2
    sign = ( in & 0x80 ) >> 7
    exp = ( in & 0x7C ) >> 2
    frac = ( in & 0x03 )
    mant = (exp==0) ? frac : (frac | 0x4) // set Jbit
    e_count = (exp==0) ? 0 : exp - 1 // set integer alignment shift count

    /* convert hf8 number into an integer 64bits number */
    magnitude.int64= mant << e_count
    res = sign ? -magnitude.int64: magnitude.int64

    return res // value is 2^16*in

```



```

define convert_hf8_to_int64( in ):
    sign = ( in & 0x80 ) >> 7
    exp = ( in & 0x78 ) >> 3
    frac = ( in & 0x07 )
    mant = (exp==0) ? frac : (frac | 0x8) // set Jbit
    e_count = (exp=0) ? 0 : exp - 1 // set integer alignment shift count

    /* convert hf8 number into an integer 64bits number */
    magnitude.int64 = mant << e_count
    res = sign ? -magnitude.int64 : magnitude.int64

    return res // value is 2^9*in

```

### 3.5 NOTATION

Instructions described in this chapter follow the general documentation convention established in *Intel® 64 and IA-32 Architectures Software Developer’s Manual Volume 2A*. Additionally, Intel® Advanced Matrix Extensions use notation conventions as described below.

In the instruction encoding boxes, **sibmem** is used to denote an encoding where a MODRM byte and SIB byte are used to indicate a memory operation where the base and displacement are used to point to memory, and the index register (if present) is used to denote a stride between memory rows. The index register is scaled by the sib.scale field as usual. The base register is added to the displacement, if present.

In the instruction encoding, the MODRM byte is represented several ways depending on the role it plays. The MODRM byte has 3 fields: 2-bit MODRM.MOD field, a 3-bit MODRM.REG field and a 3-bit MODRM.RM field. When all bits of the MODRM byte have fixed values for an instruction, the 2-hex nibble value of that byte is presented after the opcode in the encoding boxes on the instruction description pages. When only some fields of the MODRM byte must contain fixed values, those values are specified as follows:

- If only the MODRM.MOD must be 0b11, and MODRM.REG and MODRM.RM fields are unrestricted, this is denoted as **11:rrr:bbb**. The **rrr** correspond to the 3-bits of the MODRM.REG field and the **bbb** correspond to the 3-bits of the MODRM.RM field.
- If the MODRM.MOD field is constrained to be a value other than 0b11, i.e., it must be one of 0b00, 0b01, or 0b10, then we use the notation **!(11)**.
- If the MODRM.REG field had a specific required value, e.g., 0b101, that would be denoted as **mm:101:bbb**.

#### NOTE

Historically the Intel® 64 and IA-32 Architectures Software Developer’s Manual only specified the MODRM.REG field restrictions with the notation /0 ... /7 and did not specify restrictions on the MODRM.MOD and MODRM.RM fields in the encoding boxes.

### 3.6 EXCEPTION CLASSES

Alignment exceptions: The Intel AMX instructions that access memory will never generate #AC exceptions.

Table 3-2. Intel® AMX Exception Classes

Class	Description
AMX-E1	<ul style="list-style-type: none"> <li>• #UD if preceded by LOCK, 66H, F2H, F3H or REX prefixes.</li> <li>• #UD if CR4.OSXSAVE ≠ 1.</li> <li>• #UD if XCR0[18:17] ≠ 0b11.</li> <li>• #UD if IA32_EFER.LMA ≠ 1 OR CS.L ≠ 1.</li> <li>• #UD if VVVV ≠ 0b1111.</li> </ul>
	<ul style="list-style-type: none"> <li>• #GP based on palette and configuration checks (see pseudocode).</li> <li>• #GP if the memory address is in a non-canonical form.</li> </ul>
	<ul style="list-style-type: none"> <li>• #SS(0) if the memory address referencing the SS segment is in a non-canonical form.</li> </ul>
	<ul style="list-style-type: none"> <li>• #PF if a page fault occurs.</li> </ul>
AMX-E1-EVEX	All of AMX-E1 exceptions. Additionally: <ul style="list-style-type: none"> <li>• #UD if EVEX.z ≠ 0b0 // P2[7].</li> <li>• #UD if EVEX.LL' ≠ 0b00 // P2[6:5].</li> <li>• #UD if EVEX.b ≠ 0b0 // P2[4].</li> <li>• #UD if EVEX.aaa ≠ 0b000 // P2[2:0].</li> <li>• #UD if EVEX.VVVV ≠ 0b1111 // P1[6:3].</li> <li>• #UD if EVEX.V' ≠ 0b1 // P2[3].</li> </ul>
AMX-E2	<ul style="list-style-type: none"> <li>• #UD if preceded by LOCK, 66H, F2H, F3H or REX prefixes.</li> <li>• #UD if CR4.OSXSAVE ≠ 1.</li> <li>• #UD if XCR0[18:17] ≠ 0b11.</li> <li>• #UD if IA32_EFER.LMA ≠ 1 OR CS.L ≠ 1.</li> <li>• #UD if VVVV ≠ 0b1111.</li> </ul>
	<ul style="list-style-type: none"> <li>• #GP if the memory address is in a non-canonical form.</li> </ul>
	<ul style="list-style-type: none"> <li>• #SS(0) if the memory address referencing the SS segment is in a non-canonical form.</li> </ul>
	<ul style="list-style-type: none"> <li>• #PF if a page fault occurs.</li> </ul>
AMX-E2-EVEX	All of AMX-E2 exceptions. Additionally: <ul style="list-style-type: none"> <li>• #UD if EVEX.z ≠ 0b0 // P2[7].</li> <li>• #UD if EVEX.LL' ≠ 0b00 // P2[6:5].</li> <li>• #UD if EVEX.b ≠ 0b0 // P2[4].</li> <li>• #UD if EVEX.aaa ≠ 0b000 // P2[2:0].</li> <li>• #UD if EVEX.VVVV ≠ 0b1111 // P1[6:3].</li> <li>• #UD if EVEX.V' ≠ 0b1 // P2[3].</li> </ul>
AMX-E3	<ul style="list-style-type: none"> <li>• #UD if preceded by LOCK, 66H, F2H, F3H or REX prefixes.</li> <li>• #UD if CR4.OSXSAVE ≠ 1.</li> <li>• #UD if XCR0[18:17] ≠ 0b11.</li> <li>• #UD if IA32_EFER.LMA ≠ 1 OR CS.L ≠ 1.</li> <li>• #UD if VVVV ≠ 0b1111.</li> <li>• #UD if not using SIB addressing.</li> <li>• #UD if TILES_CONFIGURED == 0.</li> <li>• #UD if tsrc or tdest are not valid tiles.</li> <li>• #UD if tsrc/tdest are ≥ palette_table[tilecfg.palette_id].max_names.</li> <li>• #UD if tsrc.colbytes mod 4 ≠ 0 OR tdest.colbytes mod 4 ≠ 0.</li> <li>• #UD if tilecfg.start_row ≥ tsrc.rows OR tilecfg.start_row ≥ tdest.rows.</li> </ul>
	<ul style="list-style-type: none"> <li>• #GP if the memory address is in a non-canonical form.</li> </ul>
	<ul style="list-style-type: none"> <li>• #SS(0) if the memory address referencing the SS segment is in a non-canonical form.</li> </ul>
	<ul style="list-style-type: none"> <li>• #PF if any memory operand causes a page fault.</li> </ul>
	<ul style="list-style-type: none"> <li>• #NM if XFD[18] == 1.</li> </ul>

Table 3-2. Intel® AMX Exception Classes (Continued)

Class	Description
AMX-E3-EVEX	<p>All of AMX-E3 exceptions. Additionally:</p> <ul style="list-style-type: none"> <li>• #UD if EVEX.z <math>\neq</math> 0b0 // P2[7].</li> <li>• #UD if EVEX.LL' <math>\neq</math> 0b00 // P2[6:5].</li> <li>• #UD if EVEX.b <math>\neq</math> 0b0 // P2[4].</li> <li>• #UD if EVEX.aaa <math>\neq</math> 0b000 // P2[2:0].</li> <li>• #UD if EVEX.VVVV <math>\neq</math> 0b1111 // P1[6:3].</li> <li>• #UD if EVEX.V' <math>\neq</math> 0b1 // P2[3].</li> </ul>
AMX-E4	<ul style="list-style-type: none"> <li>• #UD if preceded by LOCK, 66H, F2H, F3H or REX prefixes.</li> <li>• #UD if CR4.OSXSAVE <math>\neq</math> 1.</li> <li>• #UD if XCR0[18:17] <math>\neq</math> 0b11.</li> <li>• #UD if IA32_EFER.LMA <math>\neq</math> 1 OR CS.L <math>\neq</math> 1.</li> <li>• #UD if srcdest == src1 OR src1 == src2 OR srcdest == src2.</li> <li>• #UD if TILES_CONFIGURED == 0.</li> <li>• #UD if srcdest.colbytes mod 4 <math>\neq</math> 0.</li> <li>• #UD if src1.colbytes mod 4 <math>\neq</math> 0.</li> <li>• #UD if src2.colbytes mod 4 <math>\neq</math> 0.</li> <li>• #UD if srcdest/src1/src2 are not valid tiles.</li> <li>• #UD if srcdest/src1/src2 are <math>\geq</math> palette_table[tilecfg.palette_id].max_names.</li> <li>• #UD if srcdest.colbytes <math>\neq</math> src2.colbytes.</li> <li>• #UD if srcdest.rows <math>\neq</math> src1.rows.</li> <li>• #UD if src1.colbytes / 4 <math>\neq</math> src2.rows.</li> <li>• #UD if srcdest.colbytes &gt; tmul_maxn.</li> <li>• #UD if src2.colbytes &gt; tmul_maxn.</li> <li>• #UD if src1.colbytes/4 &gt; tmul_maxk.</li> <li>• #UD if src2.rows &gt; tmul_maxk.</li> </ul>
AMX-E5	<ul style="list-style-type: none"> <li>• #UD if preceded by LOCK, 66H, F2H, F3H or REX prefixes.</li> <li>• #UD if CR4.OSXSAVE <math>\neq</math> 1.</li> <li>• #UD if XCR0[18:17] <math>\neq</math> 0b11.</li> <li>• #UD if IA32_EFER.LMA <math>\neq</math> 1 OR CS.L <math>\neq</math> 1.</li> <li>• #UD if VVVV <math>\neq</math> 0b1111.</li> <li>• #UD if TILES_CONFIGURED == 0.</li> <li>• #UD if tdest is not a valid tile.</li> <li>• #UD if tdest is <math>\geq</math> palette_table[tilecfg.palette_id].max_names.</li> </ul>
AMX-E6	<ul style="list-style-type: none"> <li>• #UD if preceded by LOCK, 66H, F2H, F3H or REX prefixes.</li> <li>• #UD if CR4.OSXSAVE <math>\neq</math> 1.</li> <li>• #UD if XCR0[18:17] <math>\neq</math> 0b11.</li> <li>• #UD if IA32_EFER.LMA <math>\neq</math> 1 OR CS.L <math>\neq</math> 1.</li> <li>• #UD if VVVV <math>\neq</math> 0b1111.</li> </ul>

Table 3-2. Intel® AMX Exception Classes (Continued)

Class	Description
AMX-E7-EVEX	<ul style="list-style-type: none"> <li>• #UD if preceded by LOCK, 66h, F2h, F3h or REX prefixes.</li> <li>• #UD if CR4.OSXSAVE ≠ 1.</li> <li>• #UD if XCR0[18:17] ≠ 0b11.</li> <li>• #UD if XCR0[7:5] ≠ 0b111.</li> <li>• #UD if XCR0[2:1] ≠ 0b11.</li> <li>• #UD if IA32_EFER.LMA ≠ 1 OR CS.L ≠ 1.</li> <li>• #UD if TILES_CONFIGURED == 0.</li> <li>• #UD if tsrc is not a valid tile (i.e., not configured).</li> <li>• #UD if tsrc is not a valid tile name for configured palette.</li> <li>• #UD if tsrc.colsb % 4 != 0.</li> <li>• #UD if EVEX.z ≠ 0b0 // P2[7].</li> <li>• #UD if EVEX.LL' ≠ 0b10 // P2[6:5].</li> <li>• #UD if EVEX.b ≠ 0b0 // P2[4].</li> <li>• #UD if EVEX.aaa ≠ 0b000 // P2[2:0].</li> <li>• #UD if EVEX.u ≠ 0b1 // P1[2].</li> <li>• #UD if EVEX.V' ≠ 0b1 // P2[3].</li> <li>• #UD if EVEX.VVVV ≠ 0b1111 // P1[6:3].</li> </ul>
	<ul style="list-style-type: none"> <li>• #NM if CR0[3] == 1 // TS.</li> <li>• #NM if XFD[18] == 1.</li> </ul>
	<ul style="list-style-type: none"> <li>• #GP if imm8&amp;0x3f ≥ tsrc.rows.</li> <li>• #GP if (imm8»6) * VL.bytes ≥ tsrc.colsb.</li> </ul>
AMX-E8-EVEX	<ul style="list-style-type: none"> <li>• #UD if preceded by LOCK, 66h, F2h, F3h or REX prefixes.</li> <li>• #UD if CR4.OSXSAVE ≠ 1.</li> <li>• #UD if XCR0[18:17] ≠ 0b11.</li> <li>• #UD if XCR0[7:5] ≠ 0b111.</li> <li>• #UD if XCR0[2:1] ≠ 0b11.</li> <li>• #UD if IA32_EFER.LMA ≠ 1 OR CS.L ≠ 1.</li> <li>• #UD if TILES_CONFIGURED == 0.</li> <li>• #UD if tsrc is not a valid tile (i.e., not configured).</li> <li>• #UD if tsrc is not a valid tile name for configured palette.</li> <li>• #UD if tsrc.colsb % 4 ≠ 0.</li> <li>• #UD if EVEX.z ≠ 0b0 // P2[7].</li> <li>• #UD if EVEX.LL' ≠ 0b10 // P2[6:5].</li> <li>• #UD if EVEX.b ≠ 0b0 // P2[4].</li> <li>• #UD if EVEX.aaa ≠ 0b000 // P2[2:0].</li> <li>• #UD if EVEX.u ≠ 0b1 // P1[2].</li> <li>• #UD if EVEX.V' ≠ 0b1 // P2[3].</li> </ul>
	<ul style="list-style-type: none"> <li>• #NM if CR0[3] == 1. // TS</li> <li>• #NM if XFD[18] == 1.</li> </ul>
	<ul style="list-style-type: none"> <li>• #GP if r32&amp;0xffff ≥ tsrc.rows</li> <li>• #GP if (((r32»16) &amp; 0xffff) * VL.bytes) ≥ tsrc.colsb.</li> </ul>
AMX-E9	<ul style="list-style-type: none"> <li>• #UD if preceded by LOCK, 66H, F2H, F3H or REX prefixes.</li> <li>• #UD if CR4.OSXSAVE ≠ 1.</li> <li>• #UD if XCR0[18:17] ≠ 0b11.</li> <li>• #UD if IA32_EFER.LMA ≠ 1 OR CS.L ≠ 1.</li> <li>• #UD if palette expresses state not supported by XCR0.</li> <li>• #UD if TILES_CONFIGURED == 0.</li> <li>• #UD if VEX.VVVV ≠ 0b1111.</li> <li>• #UD if src1/tdest is not a valid tile.</li> <li>• #UD if src1/tdest.colbytes % 4 ≠ 0.</li> <li>• #UD if tsrc.rows ≠ tdst.colsb/4.</li> <li>• #UD if tsrc.colsb/4 ≠ tdst.rows.</li> </ul>
	<ul style="list-style-type: none"> <li>• #NM if XFD[18] == 1.</li> </ul>

Table 3-2. Intel® AMX Exception Classes (Continued)

Class	Description
AMX-E10	<ul style="list-style-type: none"> <li>• #UD if XCR0[18:17] ≠ 0b11.</li> <li>• #UD if IA32_EFER.LMA ≠ 1 OR CS.L ≠ 1.</li> <li>• #UD if palette expresses state not supported by XCR0 (future expansion).</li> <li>• #UD if TILES_CONFIGURED == 0.</li> <li>• #UD if tsrctest == tsrc1 OR tsrc1 == tsrc2 OR tsrctest == tsrc2.</li> <li>• #UD if tsrc2.colbytes % 4 ≠ 0.</li> <li>• #UD if tsrc1.colbytes % 4 ≠ 0.</li> <li>• #UD if any of tsrctest, tsrc1, or tsrc2 are not valid tiles (i.e., not configured).</li> <li>• #UD if any of tsrctest, tsrc1, or tsrc2 are not valid tile names for configured palette.</li> <li>• #UD if tsrctest.colbytes ≠ tsrc2.colbytes.</li> <li>• #UD if tsrctest.rows ≠ tsrc1.colbytes/4.</li> <li>• #UD if tsrc1.rows ≠ tsrc2.rows.</li> <li>• #UD if tsrctest.colbytes &gt; tmul_maxn.</li> <li>• #UD if tsrc2.colbytes &gt; tmul_maxn.</li> <li>• #UD if tsrc1.rows &gt; tmul_maxk.</li> <li>• #UD if tsrc2.rows &gt; tmul_maxk.</li> </ul>
	<ul style="list-style-type: none"> <li>• #NM if XFD[18] == 1.</li> </ul>

## 3.7 INSTRUCTION SET REFERENCE

## T2RPNTLVW[Z0,Z1][,T1]—Tile Load to VNNI 16-Bit Format

Opcode/ Instruction	Op/ En	64/32 bit Mode Support	CPUID Feature Flag	Description
VEX.128.NP.OF38.WO 6E !(11):rrr:100 T2RPNTLVWZ0 tmm1+1, sibmem	A	V/N.E.	AMX-TRANPOSE	Load two tiles of data into a pair of word-interleaved tiles tmm1 and tmm2 as specified by information in sibmem.
VEX.128.NP.OF38.WO 6F !(11):rrr:100 T2RPNTLVWZOT1 tmm1+1, sibmem	A	V/N.E.	AMX-TRANPOSE	Load two tiles of data into a pair of word-interleaved tiles tmm1 and tmm2 as specified by information in sibmem with hint to optimize data caching.
VEX.128.66.OF38.WO 6E !(11):rrr:100 T2RPNTLVWZ1 tmm1+1, sibmem	A	V/N.E.	AMX-TRANPOSE	Load two tiles of data into a pair of word-interleaved tiles tmm1 and tmm2 as specified by information in sibmem.
VEX.128.66.OF38.WO 6F !(11):rrr:100 T2RPNTLVWZ1T1 tmm1+1, sibmem	A	V/N.E.	AMX-TRANPOSE	Load two tiles of data into a pair of word-interleaved tiles tmm1 and tmm2 as specified by information in sibmem with hint to optimize data caching.

### Instruction Operand Encoding

Op/En	Tuple	Operand 1	Operand 2	Operand 3	Operand 4
A	N/A	ModRM:reg (w)	ModRM:r/m (r)	N/A	N/A

### Description

This instruction loads two tiles from memory, specified via a tsib, merges each pair of adjacent rows in a word-interleaved manner, and places the results in a pair of destinations specified by tmm1.

The tile configuration for the destination tiles indicates the amount of data to read from memory. The instruction merges and interleaves pairs of rows, each output row is twice as wide as a row from memory. The instruction writes to one or two destination tiles based on the tile configuration. In the case of single destination tile the second tile register must be configured to have zero rows and columns. In the case of two tile register destinations the instruction places the maximum amount of data per (merged) row it can into the first destination register and places the remainder into the second destination register. In this case, the number of rows in both destination registers must be the same.

Since the instruction merges pairs of rows, it requires an even number of rows. The Z0 version of this instruction will read a number of rows from memory that is twice the number of rows in tmm1. The Z1 version of the instruction reads one row less than that from memory, and instead uses a virtual row of all zeros for the last row; this enables reading an odd number of rows from memory, automatically padding the data with a row of zeros.

The size of each row in memory is half the sum of the column bytes of the two destination tiles. For both destination tiles, the column bytes must be a multiple of eight.

The “T1” version provides a hint to the implementation that the data would be reused but does not need to be resident in the nearest cache levels.

Table 3-4 describes allowed configurations of the destination tiles, where MAX\_BPR is palette\_table[palette\_id].bytes\_per\_row and MAX\_ROWS is palette\_table[palette\_id].max\_rows

Any attempt to execute these instructions inside an Intel TSX transaction will result in a transaction abort.

**Table 3-3. Valid Destination Tile Configurations**

Row Size in Memory	tiles[tbase+0].rows	tiles[tbase+0].colsb	tiles[tbase+1].rows	tiles[tbase+1].colsb
≤ MAX_BPR/2	1 to MAX_ROWS	8, 16, 24, ..., MAX_BPR	0	0
> MAX_BPR/2	1 to MAX_ROWS	MAX_BPR	tiles[tbase+0].rows	8, 16, 24, ..., MAX_BPR

## Operation

### T2RPNTLVW[Z0,Z1][,T1] tdest1+1, tsib

//tiles[] is the tile register file

tbase := tdest1 & ~1 // pair base. For example, if tdest1==5 then tbase is 4

zero\_out\_of\_range\_columns (tbase)

zero\_out\_of\_range\_columns (tbase+1)

If tiles[tbase+1].rows == 0

    zero\_upper\_rows(tiles[tbase+1],0)

start := tileconfig.startRow

for n in 0 .. 1:

    zero\_upper\_rows(tiles[tbase+n],(start+1)/2)

    if start&1: // odd start values

        r := start/2

        tmp\_row := tiles[tbase+n].row[r]

        for d in 0..tiles[tbase+n].colsb/4:

            tmp\_row.dword[d].word[1] := 0

        write\_row\_and\_zero(tiles[tbase+n], r, tmp\_row, tiles[tbase+n].colsb)

for n in 0 .. 1:

    elements\_per\_row[n] := tiles[tbase+n].colsb/4

membegin := tsib.base + displacement

stride := tsib.index << tsib.scale

if T2RPNTLVWZ0[,T1]:

    pad := 0

else if T2RPNTLVWZ1[,T1]:

    pad := 1

while start < 2 \* tiles[tbase+0].rows:

    r := start / 2

    w := start % 2

    if start < 2 \* tiles[tbase+0].rows - pad:

        memptr := membegin + start \* stride

        tmp := read\_memory(memptr, (tiles[tbase].colsb + tiles[tbase+1].colsb)/2)

    else:

        tmp := 0

    for t in 0..1:

        if tiles[tbase+t].colsb > 0:

            tmp\_row := tiles[tbase + t].row[r]

            for d in 0..elements\_per\_row[t]-1:

                n := t \* elements\_per\_row[0] + d

                tmp\_row.dword[d].word[w] := tmp.word[n]

            write\_row\_and\_zero(tiles[tbase+t], r, tmp\_row,tiles[tbase+t].colsb)

    start := start + 1

zero\_tileconfig\_start()

## Flags Affected

None.



### Exceptions

VEX-encoded instructions, AMX-E11. See Section 3.6, "Exception Classes" for details.



## T2RPNTLVW[Z0,Z1]RS[,T1]—Tile Load to VNNI 16-Bit Format Optimized for Read Only Shared Data

Opcode/ Instruction	Op/ En	64/32 bit Mode Support	CPUID Feature Flag	Description
VEX.128.NP.MAP5.W0 F8 ! (11);rrr:100 T2RPNTLVWZORS tmm1+1, sibmem	A	V/N.E.	AMX-TRANPOSE AND AMX-MOVRS	Load two tiles data into a pair of word-interleaved tiles tmm1 and tmm2 as specified by information in sibmem with read-shared indication.
VEX.128.NP.MAP5.W0 F9 ! (11);rrr:100 T2RPNTLVWZORST1 tmm1+1, sibmem	A	V/N.E.	AMX-TRANPOSE AND AMX-MOVRS	Load two tiles data into a pair of word-interleaved tiles tmm1 and tmm2 as specified by information in sibmem with read-shared indication and hint to optimize data caching.
VEX.128.66.MAP5.W0 F8 ! (11);rrr:100 T2RPNTLVWZ1RS tmm1+1, sibmem	A	V/N.E.	AMX-TRANPOSE AND AMX-MOVRS	Load two tiles data into a pair of word-interleaved tiles tmm1 and tmm2 as specified by information in sibmem with read-shared indication.
VEX.128.66.MAP5.W0 F9 ! (11);rrr:100 T2RPNTLVWZ1RST1 tmm1+1, sibmem	A	V/N.E.	AMX-TRANPOSE AND AMX-MOVRS	Load two tiles data into a pair of word-interleaved tiles tmm1 and tmm2 as specified by information in sibmem with read-shared indication and hint to optimize data caching.

### Instruction Operand Encoding

Op/En	Tuple	Operand 1	Operand 2	Operand 3	Operand 4
A	N/A	ModRM:reg (w)	ModRM:r/m (r)	N/A	N/A

### Description

This instruction loads two tiles from memory, specified via a tsib, merges each pair of adjacent rows in a word-interleaved manner, and places the results in a pair of destinations specified by tmm1.

The tile configuration for the destination tiles indicates the amount of data to read from memory. The instruction merges and interleaves pairs of rows, each output row is twice as wide as a row from memory. The instruction writes to one or two destination tiles based on the tile configuration. In the case of single destination tile the second tile register must be configured to have zero rows and columns. In the case of two tile register destinations the instruction places the maximum amount of data per (merged) row it can into the first destination register and places the remainder into the second destination register. In this case, the number of rows in both destination registers must be the same.

Since the instruction merges pairs of rows, it requires an even number of rows. The Z0 version of this instruction will read a number of rows from memory that is twice the number of rows in tmm1. The Z1 version of the instruction reads one row less than that from memory, and instead uses a virtual row of all zeros for the last row; this enables reading an odd number of rows from memory, automatically padding the data with a row of zeros.

The size of each row in memory is half the sum of the column bytes of the two destination tiles. For both destination tiles, the column bytes must be a multiple of eight.

The “T1” version provides a hint to the implementation that the data would be reused but does not need to be resident in the nearest cache levels.

Table 3-4 describes allowed configurations of the destination tiles, where MAX\_BPR is palette\_table[palette\_id].bytes\_per\_row and MAX\_ROWS is palette\_table[palette\_id].max\_rows.

Any attempt to execute these instructions inside an Intel TSX transaction will result in a transaction abort.

**Table 3-4. Destination Tile Configurations**

Row Size in Memory	tiles[tbase+0].rows	tiles[tbase+0].colsb	tiles[tbase+1].rows	tiles[tbase+1].colsb
≤ MAX_BPR/2	1 to MAX_ROWS	8, 16, 24, ..., MAX_BPR	0	0
> MAX_BPR/2	1 to MAX_ROWS	MAX_BPR	tiles[tbase+0].rows	8, 16, 24, ..., MAX_BPR

Additionally, this instruction indicates the source memory location is likely to become read-shared by multiple processors, i.e., read in the future by at least one other processor before it is written, assuming it is ever written in the future. Implementations may optimize the behavior of the caches, especially shared caches, for this data for future reads by multiple processors. A future write to this data before it becomes read-shared will behave as usual, but its performance may be less optimal than if the current read were done via a load without a read-shared hint.

### Operation

See the “T2RPNTLVW[Z0,Z1],[T1]—Tile Load to VNNI 16-Bit Format” for the operation details.

### Flags Affected

None.

### Exceptions

VEX-encoded instructions, AMX-E11. See Section 3.6, “Exception Classes” for details.

## TCMMIMFP16PS/TCMMLFP16PS—Matrix Multiplication of Complex Tiles Accumulated into Packed Single Precision Tile

Opcode/ Instruction	Op/ En	64/32 bit Mode Support	CPUID Feature Flag	Description
VEX.128.66.0F38.W0 6C 11:rrr:bbb TCMMIMFP16PS tmm1, tmm2, tmm3	A	V/N.E.	AMX-COMPLEX	Matrix multiply complex elements from tmm2 and tmm3, and accumulate the imaginary part into single precision elements in tmm1.
VEX.128.NP.0F38.W0 6C 11:rrr:bbb TCMMLFP16PS tmm1, tmm2, tmm3	A	V/N.E.	AMX-COMPLEX	Matrix multiply complex elements from tmm2 and tmm3, and accumulate the real part into single precision elements in tmm1.

### Instruction Operand Encoding

Op/En	Tuple	Operand 1	Operand 2	Operand 3	Operand 4
A	N/A	ModRM:reg (r, w)	ModRM:r/m (r)	VEX.vvvv (r)	N/A

### Description

These instructions perform matrix multiplication of two tiles containing complex elements and accumulate the results into a packed single precision tile. Each dword element in input tiles tmm2 and tmm3 is interpreted as a complex number with FP16 real part and FP16 imaginary part.

TCMMLFP16PS calculates the real part of the result. For each possible combination of (row of tmm2, column of tmm3), the instruction performs a set of multiplication and accumulations on all corresponding complex numbers (one from tmm2 and one from tmm3). The real part of the tmm2 element is multiplied with the real part of the corresponding tmm3 element, and the negated imaginary part of the tmm2 element is multiplied with the imaginary part of the corresponding tmm3 elements. The two accumulated results are added, and then accumulated into the corresponding row and column of tmm1.

TCMMIMFP16PS calculates the imaginary part of the result. For each possible combination of (row of tmm2, column of tmm3), the instruction performs a set of multiplication and accumulations on all corresponding complex numbers (one from tmm2 and one from tmm3). The imaginary part of the tmm2 element is multiplied with the real part of the corresponding tmm3 element, and the real part of the tmm2 element is multiplied with the imaginary part of the corresponding tmm3 elements. The two accumulated results are added, and then accumulated into the corresponding row and column of tmm1.

“Round to nearest even” rounding mode is used when doing each accumulation of the FMA. Output denormals are always flushed to zero but FP16 input denormals are not treated as zero.

MXCSR is not consulted nor updated.

Any attempt to execute these instructions inside an Intel TSX transaction will result in a transaction abort.

### Operation

**TCMMIMFP16PS tsrcdest, tsrc1, tsrc2**

// C = m x n (tsrcdest), A = m x k (tsrc1), B = k x n (tsrc2)

# src1 and src2 elements are pairs of fp16

elements\_src1 := tsrc1.colsb / 4

elements\_dest := tsrcdest.colsb / 4

elements\_temp := tsrcdest.colsb / 2 // Count is in fp16 prior to horizontal

for m in 0 ... tsrcdest.rows-1:

temp1[0 ... elements\_temp-1] := 0

for k in 0 ... elements\_src1-1:

for n in 0 ... elements\_dest-1:

```

s1e = cvt_fp16_to_fp32(tsrc1.row[m].fp16[2*k+0]) // real
s2e = cvt_fp16_to_fp32(tsrc2.row[k].fp16[2*n+0]) // real
s1o = cvt_fp16_to_fp32(tsrc1.row[m].fp16[2*k+1]) // imaginary
s2o = cvt_fp16_to_fp32(tsrc2.row[k].fp16[2*n+1]) // imaginary

// FP32 FMA with DAZ=FTZ=1, RNE rounding.
// MXCSR is neither consulted nor updated.
// No exceptions raised or denoted.

temp1.fp32[2*n+0] = fma32(temp1.fp32[2*n+0], s1o, s2e, daz=1, ftz=1, sae=1, rc=RNE)
temp1.fp32[2*n+1] = fma32(temp1.fp32[2*n+1], s1e, s2o, daz=1, ftz=1, sae=1, rc=RNE)

```

```

for n in 0 ... elements_dest-1:
  // DAZ=FTZ=1, RNE rounding.
  // MXCSR is neither consulted nor updated.
  // No exceptions raised or denoted.
  tmpf32 := temp1.fp32[2*n] + temp1.fp32[2*n+1]
  srcdest.row[m].fp32[n] := srcdest.row[m].fp32[n] + tmpf32
write_row_and_zero(srcdest, m, tmp, srcdest.colsb)

```

```

zero_upper_rows(srcdest, srcdest.rows)
zero_tileconfig_start()

```

#### **TCMMLFP16PS srcdest, tsrc1, tsrc2**

// C = m x n (srcdest), A = m x k (tsrc1), B = k x n (tsrc2)

```

# src1 and src2 elements are pairs of fp16
elements_src1 := tsrc1.colsb / 4
elements_dest := srcdest.colsb / 4
elements_temp := srcdest.colsb / 2 // Count is in fp16 prior to horizontal

```

```

for m in 0 ... srcdest.rows-1:
  temp1[ 0 ... elements_temp-1 ] := 0
  for k in 0 ... elements_src1-1:
    for n in 0 ... elements_dest-1:

```

```

s1e = cvt_fp16_to_fp32(tsrc1.row[m].fp16[2*k+0]) // real
s2e = cvt_fp16_to_fp32(tsrc2.row[k].fp16[2*n+0]) // real
s1o = cvt_fp16_to_fp32(-tsrc1.row[m].fp16[2*k+1]) // imaginary: "-" is for imaginary*imaginary
s2o = cvt_fp16_to_fp32(tsrc2.row[k].fp16[2*n+1]) // imaginary

```

```

// FP32 FMA with DAZ=FTZ=1, RNE rounding.
// MXCSR is neither consulted nor updated.
// No exceptions raised or denoted.

```

```

temp1.fp32[2*n+0] = fma32(temp1.fp32[2*n+0], s1e, s2e, daz=1, ftz=1, sae=1, rc=RNE) // real
temp1.fp32[2*n+1] = fma32(temp1.fp32[2*n+1], s1o, s2o, daz=1, ftz=1, sae=1, rc=RNE) // imaginary

```

```

for n in 0 ... elements_dest-1:
  // DAZ=FTZ=1, RNE rounding.
  // MXCSR is neither consulted nor updated.
  // No exceptions raised or denoted.
  tmpf32 := temp1.fp32[2*n] + temp1.fp32[2*n+1]

```

```
srcdest.row[m].fp32[n] := srcdest.row[m].fp32[n] + tmpf32  
write_row_and_zero(tsrcdest, m, tmp, tsrcdest.colsb)
```

```
zero_upper_rows(tsrcdest, tsrcdest.rows)
```

```
zero_tileconfig_start()
```

#### Flags Affected

None.

#### Exceptions

AMX-E4; see Section 3.6, “Exception Classes” for details.

## TCONJTCMMIMFP16PS—Matrix Conjugate Transpose and Multiplication of Complex Tiles Accumulated into Packed Single Precision Tile

Opcode/ Instruction	Op/ En	64/32 bit Mode Support	CPUID Feature Flag	Description
VEX.128.NP.OF38.W0 6B 11:rrr:bbb TCONJTCMMIMFP16PS tmm1, tmm2, tmm3	A	V/N.E.	AMX-TRANPOSE AND AMX-COMPLEX	Matrix conjugate transpose and multiply FP16 complex numbers from tmm2 and tmm3 and accumulate with packed single precision elements in tmm1.

### Instruction Operand Encoding

Op/En	Tuple	Operand 1	Operand 2	Operand 3	Operand 4
A	N/A	ModRM:reg (r, w)	ModRM:r/m (r)	VEX.vvvv (r)	N/A

### Description

This instruction performs a matrix conjugate transpose and multiplication of two tiles containing complex elements and accumulates the results into a packed single precision tile. Each dword element in input tiles tmm2 and tmm3 is interpreted as a complex number with FP16 real part and FP16 imaginary part.

TCONJTCMMIMFP16PS calculates the imaginary part of the result. For each possible combination of (transposed column of tmm2, column of tmm3), the instruction performs a set of multiplication and accumulations on all corresponding complex numbers (one from tmm2 and one from tmm3). The negated imaginary part of the tmm2 element is multiplied with the real part of the corresponding tmm3 element, and the real part of the tmm2 element is multiplied with the imaginary part of the corresponding tmm3 elements. The two accumulated results are added, and then accumulated into the corresponding row and column of tmm1.

“Round to nearest even” rounding mode is used when doing each accumulation of the FMA. Output denormals are always flushed to zero but FP16 input denormals are not treated as zero. MXCSR is not consulted nor updated.

Any attempt to execute the TCONJTCMMIMFP16PS instruction inside an Intel TSX transaction will result in a transaction abort.

### Operation

#### TCONJTCMMIMFP16PS tsrctest, tsrc1, tsrc2

//  $C = M \times N$  (tsrctest),  $A = K \times M$  (tsrc1),  $B = K \times N$  (tsrc2)

# tsrc1 and tsrc2 elements are pairs of fp16

elements\_dest:= tsrctest.colsb/4

elements\_temp:= tsrctest.colsb/2 //count is in fp16 prior to horizontal

for m in 0 ... tsrctest.rows-1:

temp1[0 ... elements\_temp-1] := 0

for k in 0 ... tsrc1.rows-1:

for n in 0 ... elements\_dest-1:

s1e = cvt\_fp16\_to\_fp32(tsrc1.row[k].fp16[2\*m+0])

s2o = cvt\_fp16\_to\_fp32(tsrc2.row[k].fp16[2\*n+1])

s1o = cvt\_fp16\_to\_fp32(-tsrc1.row[k].fp16[2\*m+1]) // conjugate

s2e = cvt\_fp16\_to\_fp32(tsrc2.row[k].fp16[2\*n+0])

// FP32 FMA with DAZ=FTZ=1, RNE rounding. MXCSR is neither

// consulted nor updated. No exceptions raised or denoted.

temp1.fp32[2\*n+0] = fma32(temp1.fp32[2\*n+0], s1o, s2e, daz=1, ftz=1, sae=1, rc=RNE)

temp1.fp32[2\*n+1] = fma32(temp1.fp32[2\*n+1], s1e, s2o, daz=1, ftz=1, sae=1, rc=RNE)

for n in 0 ... elements\_dest-1:

// FP32 add with DAZ=FTZ=1, RNE rounding. MXCSR is neither

// consulted nor updated. No exceptions raised or denoted.

```
    tmpf32 := temp1.fp32[2*n+0] + temp1.fp32[2*n+1]
    tsrctest.row[m].fp32[n] := tsrctest.row[m].fp32[n] + tmpf32
    write_row_and_zero(tsrctest, m, tsrctest.row[m], tsrctest.colsb)
zero_upper_rows(tsrctest, tsrctest.rows)
zero_tileconfig_start()
```

#### Flags Affected

None.

#### Exceptions

AMX-E10; see Section 3.6, “Exception Classes” for details.

## TCONJTFP16—Tile Conjugate Transpose FP16-Pair Complex Elements

Opcode/ Instruction	Op/ En	64/32 bit Mode Support	CPUID Feature Flag	Description
VEX.128.66.0F38.W0 6B 11:rrr:bbb TCONJTFP16 tmm1, tmm2	A	V/N.E.	AMX-TRANPOSE AND AMX-COMPLEX	Conjugate transpose FP16-pair complex elements from tmm2 and write the result to tmm1.

### Instruction Operand Encoding

Op/En	Tuple	Operand 1	Operand 2	Operand 3	Operand 4
A	N/A	ModRM:reg (w)	ModRM:r/m (r)	N/A	N/A

### Description

This instruction performs a conjugate transpose of an FP16-pair of complex elements from tmm2 and writes the result to tmm1.

Any attempt to execute the TCONJTFP16 instruction inside an Intel TSX transaction will result in a transaction abort.

### Operation

#### TCONJTFP16 tdest, tsrc

for i in 0 ... tdest.rows-1:

  for j in 0 ... tdest.colsb/4-1:

    tmp.dword[j].fp16[0] := tsrc.row[j].dword[i].fp16[0]

    tmp.dword[j].fp16[1] := -tsrc.row[j].dword[i].fp16[1]

  write\_row\_and\_zero(tdest,i,tmp,tdest.colsb)

zero\_upper\_rows(tdest,tdest.rows)

zero\_tileconfig\_start()

### Flags Affected

None.

### Exceptions

AMX-E9; see Section 3.6, “Exception Classes” for details.



## TCVTROWD2PS—Tile Move Row and Convert INT32 to Single Precision

Opcode/ Instruction	Op/ En	64/32 bit Mode Support	CPUID Feature Flag	Description
EVEX.512.F3.0F38.W0 4A 11:rrr:bbb TCVTROWD2PS zmm1, tmm2, r32	A	V/N.E.	AMX-AVX512 AND AVX10.2	Move a row selected by r32 from tmm2 to zmm1, converting the int32 source elements to fp32.
EVEX.512.F3.0F3A.W0 07 11:rrr:bbb /ib TCVTROWD2PS zmm1, tmm2, imm8	B	V/N.E.	AMX-AVX512 AND AVX10.2	Move a row selected by imm8 from tmm2 to zmm1, converting the int32 source elements to fp32.

### Instruction Operand Encoding

Op/En	Tuple	Operand 1	Operand 2	Operand 3	Operand 4
A	N/A	ModRM:reg (w)	ModRM:r/m (r)	EVEX.vvvv (r)	N/A
B	N/A	ModRM:reg (w)	ModRM:r/m (r)	imm8 (r)	N/A

### Description

This instruction moves a row from a tile register to a zmm destination register, converting the int32 source elements to FP32. The row of the tile is selected by an imm8, or a 32-bit general-purpose register. If the row indicated is out of range, a general protection exception #GP(0) is generated.

No SIMD exceptions are generated. Rounding is done as if MXCSR.RC=RNE. Embedded rounding is not supported. MXCSR is neither consulted nor updated.

Any attempt to execute the TCVTROWD2PS instruction inside an Intel TSX transaction will result in a transaction abort.

### Operation

**TCVTROWD2PS** zdest, tsrc, r32

VL = (512)

VL\_bytes := VL >> 3 // bits to bytes

row\_index := r32&0xffff

row\_chunk := ((r32 >> 16) & 0xffff) \* VL\_bytes

for i in 0 ... (VL\_bytes/4)-1:

  if i + row\_chunk/4 >= tsrc.colsb/4:

    zdest.dword[i] := 0

  else:

    SET\_ROUNDING\_MODE\_FOR\_THIS\_INSTRUCTION(RNE);

    zdest.f32[i] := Convert\_Integer\_To\_Single\_Precision\_Floating\_Point(tsrc.row[row\_index].dword[row\_chunk/4+i]);

zdest[MAX\_VL-1:VL] := 0

zero\_tileconfig\_start()

**TCVTROWD2PS zdest, tsrc, imm8**

VL = (512)

VL\_bytes = VL >> 3 //bits to bytes

row\_index := imm8&0x3f

row\_chunk := (imm8>>6) \* VL\_bytes

for i in 0 ... (VL\_bytes/4)-1:

  if i+row\_chunk/4 >= tsrc.colsb/4:

    zdest.dword[i] := 0

  else:

    SET\_ROUNDING\_MODE\_FOR\_THIS\_INSTRUCTION(RNE);

    zdest.f32[i] := Convert\_Integer\_To\_Single\_Precision\_Floating\_Point(tsrc.row[row\_index].dword[row\_chunk/4+i]);

zdest[MAX\_VL-1:VL] := 0

zero\_tileconfig\_start()

**Flags Affected**

None.

**Exceptions**

Instruction	Exception Type
TCVTROWD2PS zdest, tsrc, r32	AMX-E8-EVEX. See Section 3.6, "Exception Classes" for details.
TCVTROWD2PS zdest, tsrc, imm8	AMX-E7-EVEX. See Section 3.6, "Exception Classes" for details.

## TCVTROWPS2BF16[H,L]—Tile Move Row and Convert FP32 Elements to BF16 Elements

Opcode/ Instruction	Op/ En	64/32 bit Mode Support	CPUID Feature Flag	Description
EVEX.512.F2.0F38.W0 6D 11:rrr:bbb TCVTROWPS2BF16H zmm1, tmm2, r32	A	V/N.E.	AMX-AVX512 AND AVX10.2	Move a row selected by r32 from tmm2 to zmm1, converting the fp32 source elements to bf16 and place the resulting bf16 elements in the high 16 bits within each dword.
EVEX.512.F2.0F3A.W0 07 11:rrr:bbb /ib TCVTROWPS2BF16H zmm1, tmm2, imm8	B	V/N.E.	AMX-AVX512 AND AVX10.2	Move a row selected by imm8 from tmm2 to zmm1, converting the fp32 source elements to bf16 and place the resulting bf16 elements in the high 16 bits within each dword.
EVEX.512.F3.0F38.W0 6D 11:rrr:bbb TCVTROWPS2BF16L zmm1, tmm2, r32	A	V/N.E.	AMX-AVX512 AND AVX10.2	Move a row selected by r32 from tmm2 to zmm1, converting the fp32 source elements to bf16 and place the resulting bf16 elements in the low 16 bits within each dword.
EVEX.512.F3.0F3A.W0 77 11:rrr:bbb /ib TCVTROWPS2BF16L zmm1, tmm2, imm8	B	V/N.E.	AMX-AVX512 AND AVX10.2	Move a row selected by imm8 from tmm2 to zmm1, converting the fp32 source elements to bf16 and place the resulting bf16 elements in the low 16 bits within each dword.

### Instruction Operand Encoding

Op/En	Tuple	Operand 1	Operand 2	Operand 3	Operand 4
A	N/A	ModRM:reg (w)	ModRM:r/m (r)	EVEX.vvvv (r)	N/A
B	N/A	ModRM:reg (w)	ModRM:r/m (r)	imm8 (r)	N/A

### Description

This instruction moves a row from a tile register to a zmm destination register, converting the FP32 source elements to BF16. The row of the tile is selected by an imm8, or a 32-bit general-purpose register. If the row indicated is out of range, a general protection exception #GP(0) is generated.

TCVTROWPS2BF16H places the resulting BF16 elements in the high 16 bits within each dword, while TCVTROWPS2BF16L places them in the low 16 bits.

No SIMD exceptions are generated. Rounding is done as if MXCSR.RC=RNE. Embedded rounding is not supported. MXCSR is neither consulted nor updated.

Any attempt to execute the TCVTROWPS2BF16[H,L] instructions inside an Intel TSX transaction will result in a transaction abort.

### Operation

#### TCVTR0WPS2BF16[H,L] zdest, tsrc, imm8

VL = (512)

VL\_bytes := VL >> 3 // bits to bytes

row\_index := imm8 & 0x3f

row\_chunk := (imm8 >> 6) \* VL\_bytes

if instruction is TCVTR0WPS2BF16H:

pos := 1

zeropos := 0

else:

pos := 0

zeropos := 1

for i in 0 ... (VL\_bytes/4)-1:

if i+row\_chunk/4 >= tsrc.colsb/4:

zdest.dword[i] := 0

else:

zdest.word[2\*i+zeropos] := 0

SET\_ROUNDING\_MODE\_FOR\_THIS\_INSTRUCTION(RNE);

zdest.bf16[2\*i+pos] := convert\_fp32\_to\_bfloat16(tsrc.row[row\_index].fp32[row\_chunk/4+i]);

zdest[MAX\_VL-1:VL] := 0

zero\_tileconfig\_start()

#### TCVTR0WPS2BF16[H,L] zdest, tsrc, r32

VL = (512)

VL\_bytes := VL >> 3 // bits to bytes

row\_index := r32 & 0xffff

row\_chunk := ((r32 >> 16) & 0xffff) \* VL\_bytes

if instruction is TCVTR0WPS2BF16H:

pos := 1

zeropos := 0

else:

pos := 0

zeropos := 1

for i in 0 ... (VL\_bytes/4)-1:

if i+row\_chunk/4 >= tsrc.colsb/4:

zdest.dword[i] := 0

else:

zdest.word[2\*i+zeropos] := 0

SET\_ROUNDING\_MODE\_FOR\_THIS\_INSTRUCTION(RNE);

zdest.bf16[2\*i+pos] := convert\_fp32\_to\_bfloat16(tsrc.row[row\_index].fp32[row\_chunk/4+i]);

zdest[MAX\_VL-1:VL] := 0

zero\_tileconfig\_start()

### Flags Affected

None.

**Exceptions**

<b>Instruction</b>	<b>Exception Type</b>
TCVTROWPS2BF16H zmm1, tmm2, r32	AMX-E8-EVEX. See Section 3.6, "Exception Classes" for details.
TCVTROWPS2BF16H zmm1, tmm2, imm8	AMX-E7-EVEX. See Section 3.6, "Exception Classes" for details.
TCVTROWPS2BF16L zmm1, tmm2, r32	AMX-E8-EVEX. See Section 3.6, "Exception Classes" for details.
TCVTROWPS2BF16L zmm1, tmm2, imm8	AMX-E7-EVEX. See Section 3.6, "Exception Classes" for details.

## TCVTROWPS2PH[H,L]—Tile Move Row and Convert Single Precision to FP16

Opcode/ Instruction	Op/ En	64/32 bit Mode Support	CPUID Feature Flag	Description
EVEX.512.NP.0F38.W0 6D 11:rrr:bbb TCVTROWPS2PHH zmm1, tmm2, r32	A	V/N.E.	AMX-AVX512 AND AVX10.2	Move a row selected by r32 from tmm2 to zmm1, converting the fp32 source elements to fp16 and place the resulting fp16 elements in the high 16 bits within each dword.
EVEX.512.NP.0F3A.W0 07 11:rrr:bbb /ib TCVTROWPS2PHH zmm1, tmm2, imm8	B	V/N.E.	AMX-AVX512 AND AVX10.2	Move a row selected by imm8 from tmm2 to zmm1, converting the fp32 source elements to fp16 and place the resulting fp16 elements in the high 16 bits within each dword.
EVEX.512.66.0F38.W0 6D 11:rrr:bbb TCVTROWPS2PHL zmm1, tmm2, r32	A	V/N.E.	AMX-AVX512 AND AVX10.2	Move a row selected by r32 from tmm2 to zmm1, converting the fp32 source elements to fp16 and place the resulting fp16 elements in the low 16 bits within each dword.
EVEX.512.F2.0F3A.W0 77 11:rrr:bbb /ib TCVTROWPS2PHL zmm1, tmm2, imm8	B	V/N.E.	AMX-AVX512 AND AVX10.2	Move a row selected by imm8 from tmm2 to zmm1, converting the fp32 source elements to fp16 and place the resulting fp16 elements in the low 16 bits within each dword.

## Instruction Operand Encoding

Op/En	Tuple	Operand 1	Operand 2	Operand 3	Operand 4
A	N/A	ModRM:reg (w)	ModRM:r/m (r)	EVEX.vvvv (r)	N/A
B	N/A	ModRM:reg (w)	ModRM:r/m (r)	imm8 (r)	N/A

## Description

This instruction moves a row from a tile register to a zmm destination register, converting the FP32 source elements to FP16. The row of the tile is selected by an imm8, or a 32-bit general-purpose register. If the row indicated is out of range, a general protection exception #GP(0) is generated.

TCVTROWPS2PHH places the resulting FP16 elements in the high 16 bits within each dword, while TCVTROWPS2PHL places them in the low 16 bits.

No SIMD exceptions are generated. Rounding is done as if MXCSR.RC=RNE. Embedded rounding is not supported. MXCSR is neither consulted nor updated.

Input FP32 denormals become FP16 zeros on outputs. This instruction can produce FP16 denormal outputs. (MXCSR.FTZ only controls FP32 and FP64 denormal outputs).

Any attempt to execute the TCVTROWPS2PH[H,L] instructions inside an Intel TSX transaction will result in a transaction abort.

### Operation

#### TCVTROWPS2PH[H,L] zdest, tsrc, imm8

VL = (512)

VL\_bytes := VL >> 3 // bits to bytes

row\_index := imm8 & 0x3f

row\_chunk := (imm8 >> 6) \* VL\_bytes

if instruction is TCVTROWPS2PHH:

pos := 1

zeropos := 0

else:

pos := 0

zeropos := 1

for i in 0 ... (VL\_bytes/4)-1:

if i+row\_chunk/4 >= tsrc.colsb/4:

zdest.dword[i] := 0

else:

zdest.word[2\*i+zeropos] := 0

SET\_ROUNDING\_MODE\_FOR\_THIS\_INSTRUCTION(RNE);

zdest.f16[2\*i+pos] := vCvt\_s2h(tsrc.row[row\_index].fp32[2\*row\_chunk/4+i]);

zdest[MAX\_VL-1:VL] := 0

zero\_tileconfig\_start()

#### TCVTROWPS2PH[H,L] zdest, tsrc, r32

VL = (512)

VL\_bytes := VL >> 3 // bits to bytes

row\_index := r32 & 0xffff

row\_chunk := ((r32 >> 16) & 0xffff) \* VL\_bytes

if instruction is TCVTROWPS2PHH:

pos := 1

zeropos := 0

else:

pos := 0

zeropos := 1

for i in 0 ... (VL\_bytes/4)-1:

if i + row\_chunk/4 >= tsrc.colsb/4:

zdest.dword[i] := 0

else:

zdest.word[2\*i+zeropos] := 0

SET\_ROUNDING\_MODE\_FOR\_THIS\_INSTRUCTION(RNE);

zdest.f16[2\*i+pos] := vCvt\_s2h(tsrc.row[row\_index].fp32[2\*row\_chunk/4+i]);

zdest[MAX\_VL-1:VL] := 0

zero\_tileconfig\_start()

### Flags Affected

None.

**Exceptions**

<b>Instruction</b>	<b>Exception Type</b>
TCVTROWPS2PHH zmm1, tmm2, r32	AMX-E8-EVEX. See Section 3.6, "Exception Classes" for details.
TCVTROWPS2PHH zmm1, tmm2, imm8	AMX-E7-EVEX. See Section 3.6, "Exception Classes" for details.
TCVTROWPS2PHL zmm1, tmm2, r32	AMX-E8-EVEX. See Section 3.6, "Exception Classes" for details.
TCVTROWPS2PHL zmm1, tmm2, imm8	AMX-E7-EVEX. See Section 3.6, "Exception Classes" for details.



## TDP[B,H,BH,HB]F8PS—Dot Product of FP8 Tiles Accumulated into Packed Single Precision Tile

Opcode/ Instruction	Op/ En	64/32 bit Mode Support	CPUID Feature Flag	Description
VEX.128.NP.MAP5.W0 FD 11:rrr:bbb TDPBF8PS tmm1, tmm2, tmm3	A	V/N.E.	AMX-FP8	Matrix multiply BF8 elements from tmm2 and tmm3 and accumulate the packed single precision elements in tmm1.
VEX.128.F2.MAP5.W0 FD 11:rrr:bbb TDPBHF8PS tmm1, tmm2, tmm3	A	V/N.E.	AMX-FP8	Matrix multiply HF8 elements from tmm2 and tmm3 and accumulate the packed single precision elements in tmm1.
VEX.128.F3.MAP5.W0 FD 11:rrr:bbb TDPHBF8PS tmm1, tmm2, tmm3	A	V/N.E.	AMX-FP8	Matrix multiply BF8 elements from tmm2 and HF8 elements from tmm3 and accumulate the packed single precision elements in tmm1.
VEX.128.66.MAP5.W0 FD 11:rrr:bbb TDPHF8PS tmm1, tmm2, tmm3	A	V/N.E.	AMX-FP8	Matrix multiply HF8 elements from tmm2 and BF8 elements from tmm3 and accumulate the packed single precision elements in tmm1.

### Instruction Operand Encoding

Op/En	Tuple	Operand 1	Operand 2	Operand 3	Operand 4
A	N/A	ModRM:reg (r, w)	ModRM:r/m (r)	VEX.vvvv (r)	N/A

### Description

These instructions compute dot product of brain-float8 (BF8) or hybrid-float8 (HF8) accumulating into a single precision (FP32). The input elements can be BF8 or HF8. These instructions have three tile operands, one source/dest accumulator operand, and two source operands, src1 and src2. The src1 and src2 operands can be BF8 or HF8 independently, and the source/dest operand is always FP32.

TDPBF8PS is the dot product of a BF8 value (src1) by a BF8 value (src2) accumulating into a Single Precision (FP32) source/dest.

TDPHF8PS is the dot product of an HF8 value (src1) by an HF8 value (src2) accumulating into a Single Precision (FP32) source/dest.

TDPBHF8PS is the dot product of a BF8 value (src1) by an HF8 value (src2) accumulating into a Single Precision (FP32) source/dest.

TDPHBF8PS is the dot product of an HF8 value (src1) by a BF8 value (src2) accumulating into a Single Precision (FP32) source/dest.

All operations treat the presence of an input NaN value (in src and srcdest) as resulting in an FP32 QNaN\_Indefinite response in the destination of that operation, where a FP32 QNaN indefinite value is 0xFFC0.0000:

- Sign='1
- Exp[7:0]= 0xFF
- Fraction[22:0]=0x40.0000

The tile registers specified must be distinct from one another, no repeats.

Rounding is always RNE. For the inputs, DAZ==0 is assumed, for the output FTZ==1 is assumed.

MXCSR is neither consulted nor updated, no exceptions are raised or denoted.

Any attempt to execute the TDP[B,H,BH,HB]F8PS instructions inside an Intel TSX transaction will result in a transaction abort.

## Operation

### TDP[B,H,BH,HB]F8PS tsrcdest, tsrc1, tsrc2

//  $C = m \times n$  (tsrcdest),  $A = m \times k$  (tsrc1),  $B = k \times n$  (tsrc2)

# src1 and src2 elements are 4-tuples of bfloat8 or hfloat8

elements\_src1 = tsrc1.colsb / 4

elements\_dest = tsrcdest.colsb / 4

elements\_temp1 = tsrcdest.colsb / 4

if \*tsrc1 is bfloat8\*:

    type1 = bf8

else:

    type1 = hf8

if \*tsrc2 is bfloat8\*:

    type2 = bf8

else:

    type2 = hf8

for m in 0 ... tsrcdest.rows-1:

    temp1[ 0 ... elements\_temp1-1 ] = 0

    for k in 0 ... elements\_src1-1:

        for n in 0 ... elements\_dest-1:

            // FP32 MUL with DAZ=1, FTZ=1, RNE rounding.

            // MXCSR is neither consulted nor updated.

            // No exceptions raised or denoted.

            s1e0.int64 = convert\_fp8\_to\_fixpoint64(tsrc1.row[m].float8[4\*k+0], type1)

            s2e0.int64 = convert\_fp8\_to\_fixpoint64(tsrc2.row[k].float8[4\*n+0], type2)

            s1e1.int64 = convert\_fp8\_to\_fixpoint64(tsrc1.row[m].float8[4\*k+1], type1)

            s2e1.int64 = convert\_fp8\_to\_fixpoint64(tsrc2.row[k].float8[4\*n+1], type2)

            s1e2.int64 = convert\_fp8\_to\_fixpoint64(tsrc1.row[m].float8[4\*k+2], type1)

            s2e2.int64 = convert\_fp8\_to\_fixpoint64(tsrc2.row[k].float8[4\*n+2], type2)

            s1e3.int64 = convert\_fp8\_to\_fixpoint64(tsrc1.row[m].float8[4\*k+3], type1)

            s2e3.int64 = convert\_fp8\_to\_fixpoint64(tsrc2.row[k].float8[4\*n+3], type2)

            temp.int128 = s1e0.int64 \* s2e0.int64 + s1e1.int64 \* s2e1.int64 + s1e2.int64 \* s2e2.int64 + s1e3.int64 \* s2e3.int64

            temp1.int128[n] += temp.int128

            // INF Computation treatment:

            // -----

            // mult(INF, normal) = INF (dest.sign == negative if INF.sign != normal.sign)

            // add(INF, normal) = INF (dest.sign == INF.sign)

            // mult(INF, ZERO) = QNaN\_indefinite (i.e. invalid operation)

            // add(+INF, -INF) = QNaN\_indefinite (i.e. invalid operation)

            // NaN treatment:

            // -----

            // if any element:

            // \* tsrc1.row[m].float8[4k, 4k+1, 4k+2, 4k+3],

            // \* tsrc2.row[k].float8[4n, 4n+1, 4n+2, 4n+3], or

            // \* tsrcdest.row[m].float32[n]

            // has any NaN value, then the corresponding result

            // tsrcdest.row[m].float32[n] is 0xFFC0.000 (QNaN Indefinite)

```
for n in 0 ... elements_dest-1:  
    // FTZ=1, RNE rounding.  
    // MXCSR is neither consulted nor updated.  
    // No exceptions raised or denoted.  
    tmpf32 = convert_fixpoint128_to_fp32(temp1.int128[n], type1, type2)  
    tmp.row[m].fp32[n] = srcdest.row[m].fp32[n] + tmpf32
```

```
write_row_and_zero(srcdest, m, tmp, srcdest.colsb)  
zero_upper_rows(srcdest, srcdest.rows)  
zero_tileconfig_start()
```

### Flags Affected

None.

### Exceptions

AMX-E4; see Section 3.6, “Exception Classes” for details.

## TILELOADRS[T1]—Load Tile Format Optimized for Read Only Shared Data

Opcode/ Instruction	Op/ En	64/32 bit Mode Support	CPUID Feature Flag	Description
VEX.128.F2.0F38.W0 4A !{11};rrr:100 TILELOADRS tmm1, sibmem	A	V/N.E.	AMX-MOVR	Load data into tmm1 as specified by information in sibmem with read-shared indication.
VEX.128.66.0F38.W0 4A !{11};rrr:100 TILELOADRST1 tmm1, sibmem	A	V/N.E.	AMX-MOVR	Load data into tmm1 as specified by information in sibmem with read-shared indication.

### Instruction Operand Encoding

Op/En	Tuple	Operand 1	Operand 2	Operand 3	Operand 4
A	N/A	ModRM:reg (w)	ModRM:r/m (r)	N/A	N/A

### Description

This instruction moves data from the source operand (second operand), a memory operand, to the destination operand (first operand), a register. This instruction may be used to load a TMM register from memory. The amount of data moved is specified by the tile register operand's tile configuration. Additionally, this instruction indicates the source memory location is likely to become read-shared by multiple processors, i.e., read in the future by at least one other processor before it is written, assuming it is ever written in the future.

Implementations may optimize the behavior of the caches, especially shared caches, for this data for future reads by multiple processors. A future write to this data before it becomes read-shared will behave as usual, but its performance may be less optimal than if the current read were done via a load without a read-shared hint.

The TILECFG.start\_row in the XTILECFG data should be initialized to '0' in order to load or store the entire tile and is set to zero on successful completion of the instruction. This is a restartable instruction and the TILECFG.start\_row will be non-zero when restartable events occur during the instruction execution.

Any attempt to execute these instructions inside an Intel TSX transaction will result in a transaction abort.

### Operation

#### TILELOADRS[T1] tdest, tsib

```

start := tilecfg.start_row
zero_out_of_range_columns (tdest)
zero_upper_rows(tdest,start)
membegin := tsib.base + displacement
// if no index register in the SIB encoding, the value zero is used.
stride := tsib.index << tsib.scale
nbytes := tdest.colsb
while start < tdest.rows:
    memptr := membbegin + start * stride
    write_row_and_zero(tdest, start, read_memory(memptr, nbytes), nbytes)
    start := start + 1
zero_tilecfg_start()
// In the case of a memory fault in the middle of an instruction, the tilecfg.start_row := start

```

### Flags Affected

None.

### Exceptions

VEX-encoded instructions, AMX-E3. See Section 3.6, "Exception Classes" for details.

EVEX-encoded instructions, AMX-E3-EVEX. See Section 3.6, "Exception Classes" for details.

## TILEMOVROW—Tile Move Row

Opcode/ Instruction	Op/ En	64/32 bit Mode Support	CPUID Feature Flag	Description
EVEX.512.66.0F3A.W0 07 11:rrr:bbb /ib TILEMOVROW zmm1, tmm2, imm8	A	V/N.E.	AMX-AVX512 AND AVX10.2	Move a row specified by imm8 from tmm2 to zmm1.
EVEX.512.66.0F38.W0 4A 11:rrr:bbb TILEMOVROW zmm1, tmm2, r32	B	V/N.E.	AMX-AVX512 AND AVX10.2	Move a row specified by r32 from tmm2 to zmm1.

### Instruction Operand Encoding

Op/En	Tuple	Operand 1	Operand 2	Operand 3	Operand 4
A	N/A	ModRM:reg (w)	ModRM:r/m (r)	imm8 (r)	N/A
B	N/A	ModRM:reg (w)	ModRM:r/m (r)	EVEX.vvvv (r)	N/A

### Description

These instructions move one row of a tile register to a zmm register. The row of the tile is selected by an imm8, or a 32-bit general-purpose register. If the row indicated is out of range, a general protection exception #GP(0) is generated.

Any attempt to execute the TILEMOVROW instruction inside an Intel TSX transaction will result in a transaction abort.

### Operation

**TILEMOVROW** zdest, tsrc, imm8

VL = (512)

VL\_bytes := VL >> 3 // bits to bytes

row\_index := imm8 & 0x3f

row\_chunk := (imm8 >> 6) \* VL\_bytes

for i in 0 ... VL\_bytes-1:

  if row\_chunk + i >= tsrc.colsb:

    zdest.byte[i] := 0

  else:

    zdest.byte[i] := tsrc.row[row\_index].byte[row\_chunk+i]

zdest[MAX\_VL-1:VL] := 0

zero\_tileconfig\_start()

**TILEMOVROW zdest, tsrc, r32**

VL = (512)

VL\_bytes := VL &gt;&gt; 3 // bits to bytes

row\_index := r32 &amp; 0xffff

row\_chunk := ((r32 &gt;&gt; 16) &amp; 0xffff) \* VL\_bytes

for i in 0 ... VL\_bytes-1:

if row\_chunk + i &gt;= tsrc.colsb:

zdest.byte[i] := 0

else:

zdest.byte[i] := tsrc.row[row\_index].byte[row\_chunk+i]

zdest[MAX\_VL-1:VL] := 0

zero\_tileconfig\_start()

**Flags Affected**

None.

**Exceptions**

Instruction	Exception Type
TILEMOVROW zmm1, tmm2, r32	AMX-E7-EVEX. See Section 3.6, "Exception Classes" for details.
TILEMOVROW zmm1, tmm2, imm8	AMX-E8-EVEX. See Section 3.6, "Exception Classes" for details.

## TMMULTF32PS—Matrix Multiplication of TF32 Tiles into Packed Single Precision Tile

Opcode/ Instruction	Op/ En	64/32 bit Mode Support	CPUID Feature Flag	Description
VEX.128.66.0F38.W0 48 11:rrr:bbb TMMULTF32PS tmm1, tmm2, tmm3	A	V/N.E.	AMX-TF32	Matrix multiply single precision elements converted to TF32 from tmm2 and tmm3, and accumulate the packed single precision elements in tmm1.

### Instruction Operand Encoding

Op/En	Tuple	Operand 1	Operand 2	Operand 3	Operand 4
A	N/A	ModRM:reg (r, w)	ModRM:r/m (r)	VEX.vvvv (r)	N/A

### Description

This instruction performs matrix multiplication of two tiles containing single precision elements converted to TF32 and accumulates the results into a packed single precision tile. For each possible combination of (row of tmm2, column of tmm3), the instruction performs a convert to TF32, multiply and then accumulates the result into the corresponding row and column of tmm1.

“Round to nearest even” rounding mode is used when doing each accumulation of the FMA. Output FP32 denormals are always flushed to zero. Input single precision denormals are always handled and not treated as zero.

MXCSR is not consulted nor updated.

Any attempt to execute the TMMULTF32PS instruction inside an Intel TSX transaction will result in a transaction abort.

### Operation

```
define zero_lower_mantissa_bits_fp32(x):
    // the input is an fp32 number.
    // the output is a fp32 number with the low 13 bits set to zero
    // This is masked FP32 referred to as TF32.
    dword := 0
    dword[31:13] := x[31:13]
    return dword

define silence_snan_fp32(x):
    // SNAN has exponent 255 and high fraction bit set to 0 and
    // nonzero other fraction bits.
    if x.exponent == 255 and x.fraction != 0 and x.fraction[22] == 0:
        x.fraction[22] := 1
    return x
```

### TMMULTF32PS tsrcdest, tsrc1, tsrc2

```
// C = m x n (tsrcdest), A = m x k (tsrc1), B = k x n (tsrc2)
# src1 and src2 elements are fp32
elements_src1 := tsrc1.colsb / 4
elements_src2 := tsrc2.colsb / 4
elements_dest := tsrcdest.colsb / 4
elements_temp := tsrcdest.colsb / 4

for m in 0 ... tsrcdest.rows-1:
    temp1[0 ... elements_temp-1] := 0
    for k in 0 ... elements_src1-1:
```

```

for n in 0 ... elements_dest-1:
// FP32 FMA with DAZ=FTZ=1, RNE rounding.
// MXCSR is neither consulted nor updated.
// No exceptions raised or denoted.
a := silence_snan_fp32(tsrc1.row[m].fp32[k])
b := silence_snan_fp32(tsrc2.row[k].fp32[n])
temp1.fp32[n] += zero_lower_mantissa_bits_fp32(a) * zero_lower_mantissa_bits_fp32(b)

```

```

for n in 0 ... elements_dest-1:
// DAZ=FTZ=1, RNE rounding.
// MXCSR is neither consulted nor updated.
// No exceptions raised or denoted.
srcdest.row[m].fp32[n] := srcdest.row[m].fp32[n] + temp1.fp32[n]
write_row_and_zero(tsrcdest, m, tmp, tsrcdest.colsb)

```

```

zero_upper_rows(tsrcdest, tsrcdest.rows)
zero_tileconfig_start()

```

### Flags Affected

None.

### Exceptions

AMX-E4; see Section 3.6, “Exception Classes” for details.



## TTCMM[IM,RL]FP16PS—Matrix Transpose and Multiplication of Complex Tiles Accumulated into Packed Single Precision Tile

Opcode/ Instruction	Op/ En	64/32 bit Mode Support	CPUID Feature Flag	Description
VEX.128.F2.0F38.W0 6B 11:rrr:bbb TTCMMIMFP16PS tmm1, tmm2, tmm3	A	V/N.E.	AMX-TRANPOSE AND AMX-COMPLEX	Matrix multiply complex elements from dword transposed tmm2 and tmm3, and accumulate the imaginary part into single precision elements in tmm1.
VEX.128.F3.0F38.W0 6B 11:rrr:bbb TTCMMRLFP16PS tmm1, tmm2, tmm3	A	V/N.E.	AMX-TRANPOSE AND AMX-COMPLEX	Matrix multiply complex elements from dword transposed tmm2 and tmm3, and accumulate the real part into single precision elements in tmm1.

### Instruction Operand Encoding

Op/En	Tuple	Operand 1	Operand 2	Operand 3	Operand 4
A	N/A	ModRM:reg (r, w)	ModRM:r/m (r)	VEX.vvvv (r)	N/A

### Description

These instructions perform matrix transpose and multiplication of two tiles containing complex elements and accumulate the results into a packed single precision tile. Each dword element in input tiles tmm2 and tmm3 is interpreted as a complex number with FP16 real part and FP16 imaginary part.

The TTCMMRLFP16PS instruction calculates the real part of the result. For each possible combination of (transposed column of tmm2, column of tmm3), the instruction performs a set of multiplication and accumulations on all corresponding complex numbers (one from tmm2 and one from tmm3). The real part of the tmm2 element is multiplied with the real part of the corresponding tmm3 element, and the negated imaginary part of the tmm2 element is multiplied with the imaginary part of the corresponding tmm3 elements. The two accumulated results are added, and then accumulated into the corresponding row and column of tmm1.

The TTCMMIMFP16PS instruction calculates the imaginary part of the result. For each possible combination of (transposed column of tmm2, column of tmm3), the instruction performs a set of multiplication and accumulations on all corresponding complex numbers (one from tmm2 and one from tmm3). The imaginary part of the tmm2 element is multiplied with the real part of the corresponding tmm3 element, and the real part of the tmm2 element is multiplied with the imaginary part of the corresponding tmm3 elements. The two accumulated results are added, and then accumulated into the corresponding row and column of tmm1.

“Round to nearest even” rounding mode is used when doing each accumulation of the FMA. Output denormals are always flushed to zero but FP16 input denormals are not treated as zero. MXCSR is not consulted nor updated.

Any attempt to execute the TTCMM[IM,RL]FP16PS instructions inside an Intel TSX transaction will result in a transaction abort.

### Operation

#### TTCMMRLFP16PS tsrcdest, tsrc1, tsrc2

//  $C = m \times n$  (tsrcdest),  $A = k \times m$  (tsrc1),  $B = k \times n$  (tsrc2)

# src1 and src2 elements are pairs of fp16

elements\_dest := tsrcdest.colsb / 4

elements\_temp := tsrcdest.colsb / 2 // Count is in fp16 prior to horizontal

for m in 0 ... tsrcdest.rows-1:

temp1[ 0 ... elements\_temp-1 ] := 0

for k in 0 ... tsrc1-1:

for n in 0 ... elements\_dest-1:

s1e = cvt\_fp16\_to\_fp32(tsrc1.row[k].fp16[2\*m+0])

s2e = cvt\_fp16\_to\_fp32(tsrc2.row[k].fp16[2\*n+0])

```

s1o = cvt_fp16_to_fp32(-tsrc1.row[k].fp16[2*m+1]) // imaginary*imaginary
s2o = cvt_fp16_to_fp32(tsrc2.row[k].fp16[2*n+1])
// FP32 FMA with DAZ=FTZ=1, RNE rounding.
// MXCSR is neither consulted nor updated.
// No exceptions raised or denoted.
temp1.fp32[2*n+0] = fma32(temp1.fp32[2*n+0], s1e, s2e, daz=1, ftz=1, sae=1, rc=RNE)
temp1.fp32[2*n+1] = fma32(temp1.fp32[2*n+1], s1o, s2o, daz=1, ftz=1, sae=1, rc=RNE)

```

```

for n in 0 ... elements_dest-1:
// DAZ=FTZ=1, RNE rounding.
// MXCSR is neither consulted nor updated.
// No exceptions raised or denoted.
tmpf32 := temp1.fp32[2*n] + temp1.fp32[2*n+1]
srcdest.row[m].fp32[n] := srcdest.row[m].fp32[n] + tmpf32
write_row_and_zero(srcdest, m, tmp, srcdest.colsb)

```

```

zero_upper_rows(srcdest, srcdest.rows)
zero_tileconfig_start()

```

#### **TTCMMIMFP16PS srcdest, tsrc1, tsrc2**

```

// C = m x n (srcdest), A = k x m (tsrc1), B = k x n (tsrc2)
# src1 and src2 elements are pairs of fp16
elements_dest := srcdest.colsb / 4
elements_temp := srcdest.colsb / 2 // Count is in fp16 prior to horizontal

```

```

for m in 0 ... srcdest.rows-1:
temp1[ 0 ... elements_temp-1 ] := 0
for k in 0 ... tsrc1.rows-1:
for n in 0 ... elements_dest-1:
s1e = cvt_fp16_to_fp32(tsrc1.row[k].fp16[2*m+0])
s2o = cvt_fp16_to_fp32(tsrc2.row[k].fp16[2*n+1])
s1o = cvt_fp16_to_fp32(tsrc1.row[k].fp16[2*m+1])
s2e = cvt_fp16_to_fp32(tsrc2.row[k].fp16[2*n+0])

// FP32 FMA with DAZ=FTZ=1, RNE rounding.
// MXCSR is neither consulted nor updated.
// No exceptions raised or denoted.

temp1.fp32[2*n+0] = fma32(temp1.fp32[2*n+0], s1o, s2e, daz=1, ftz=1, sae=1, rc=RNE)
temp1.fp32[2*n+1] = fma32(temp1.fp32[2*n+1], s1e, s2o, daz=1, ftz=1, sae=1, rc=RNE)

```

```

for n in 0 ... elements_dest-1:
// DAZ=FTZ=1, RNE rounding.
// MXCSR is neither consulted nor updated.
// No exceptions raised or denoted.
tmpf32 := temp1.fp32[2*n] + temp1.fp32[2*n+1]
srcdest.row[m].fp32[n] := srcdest.row[m].fp32[n] + tmpf32
write_row_and_zero(srcdest, m, tmp, srcdest.colsb)

```

```

zero_upper_rows(srcdest, srcdest.rows)
zero_tileconfig_start()

```

#### **Flags Affected**

None.

**Exceptions**

AMX-E10; see Section 3.6, “Exception Classes” for details.

## TTDPBF16PS—Dot Product and Transpose of BF16 Tiles Accumulated into Packed Single Precision Tile

Opcode/ Instruction	Op/ En	64/32 bit Mode Support	CPUID Feature Flag	Description
VEX.128.F3.0F38.W0 6C 11:rrr:bbb TTDPBF16PS tmm1, tmm2, tmm3	A	V/N.E.	AMX-TRANPOSE AND AMX-BF16	Matrix multiply BF16 elements from dword transposed tmm2 and tmm3, and accumulate the packed single precision elements in tmm1.

### Instruction Operand Encoding

Op/En	Tuple	Operand 1	Operand 2	Operand 3	Operand 4
A	N/A	ModRM:reg (r, w)	ModRM:r/m (r)	VEX.vvvv (r)	N/A

### Description

This instruction computes the transpose and dot product of BF16 pairs, accumulating to single precision. This instruction has three tile operands, one source/dest accumulator operand, and two source operands, src1 and src2. Src1 is transposed and matrix multiplied with src2. The transpose operation is done in BF16 pair granularity, transforming columns of BF16 pairs into rows. The tile registers specified must be distinct from one another, no repeats. Any attempt to execute the TTDPBF16PS instruction inside an Intel TSX transaction will result in a transaction abort.

### Operation

```
// C = M x N (tsrcdest), A = K x M (tsrc1), B = K x N (tsrc2)
// src1 and src2 elements are pairs of bfloat16
elements_dest:= tsrcdest.colsb/4
elements_temp:= tsrcdest.colsb/2 //count is in bfloat16 prior to horizontal

for m in 0 ... tsrcdest.rows-1
  temp1[0 ... elements_temp-1] := 0
  for k in 0 ... tsrc1.rows-1:
    for n in 0 ... elements_dest-1:
      s1e = make_fp32(tsrc1.row[k],bfloat16[2*m+0])
      s2e = make_fp32(tsrc2.row[k],bfloat16[2*n+0])
      s1o = make_fp32(tsrc1.row[k],bfloat16[2*m+1])
      s2o = make_fp32(tsrc2.row[k],bfloat16[2*n+1])

      // FP32 FMA with DAZ=FTZ=1, RNE rounding. MXCSR is neither
      // consulted nor updated. No exceptions raised or denoted.

      temp1.fp32[2*n+0] = fma32(temp1.fp32[2*n+0], s1e, s2e, daz=1, ftz=1, sae=1, rc=RNE)
      temp1.fp32[2*n+1] = fma32(temp1.fp32[2*n+1], s1o, s2o, daz=1, ftz=1, sae=1, rc=RNE)

    for n in 0 ... Elements_dest-1:
      // FP32 add with DAZ=FTZ=1, RNE rounding. MXCSR is neither
      // consulted nor updated. No exceptions raised or denoted.

      tmpf32 := temp1.fp32[2*n+0] + temp1.fp32[2*n+1]
      tsrcdest.row[m].fp32[n] := srcdest.row[m].fp32[n] + tmpf32

write_row_and_zero(tsrcdest, m, tmp, tsrcdest.colsb)
```

zero\_upper\_rows(tsrcdest, tsrcdest.rows)  
zero\_tileconfig\_start()

**Flags Affected**

None.

**Exceptions**

AMX-E10; see Section 3.6, “Exception Classes” for details.

## TTDFP16PS—Dot Product and Transpose of FP16 Tiles Accumulated into Packed Single Precision Tile

Opcode/ Instruction	Op/ En	64/32 bit Mode Support	CPUID Feature Flag	Description
VEX.128.F2.0F38.W0 6C 11:rrr:bbb TTDFP16PS tmm1, tmm2, tmm3	A	V/N.E.	AMX-TRANPOSE AND AMX-FP16	Matrix multiply FP16 elements from dword transposed tmm2 and tmm3, and accumulate the packed single precision elements in tmm1.

### Instruction Operand Encoding

Op/En	Tuple	Operand 1	Operand 2	Operand 3	Operand 4
A	N/A	ModRM:reg (r, w)	ModRM:r/m (r)	VEX.vvvv (r)	N/A

### Description

This instruction computes the transpose and dot product of FP16 pairs, accumulating to single precision. This instruction has three tile operands, one source/dest accumulator operand, and two source operands, src1 and src2. Src1 is transposed and matrix multiplied with src2. The transpose operation is done in FP16 pair granularity, transforming columns of FP16 pairs into rows. The tile registers specified must be distinct from one another, no repeats. Any attempt to execute the TTDFP16PS instruction inside an Intel TSX transaction will result in a transaction abort.

### Operation

```
// C = M x N (tsrcdest), A = K x M (tsrc1), B = K x N (tsrc2)
```

```
# tsrc1 and tsrc2 elements are pairs of fp16
```

```
elements_dest:= tsrcdest.colsb/4
```

```
elements_temp:= tsrcdest.colsb/2 //count is in fp16 prior to horizontal
```

```
for m in 0 ... tsrcdest.rows-1:
```

```
  temp1[0 ... elements_temp-1] := 0
```

```
  for k in 0 ... tsrc1.rows-1:
```

```
    for n in 0 ... elements_dest-1:
```

```
      s1e = cvt_fp16_to_fp32(tsrc1.row[k].fp16[2*m+0])
```

```
      s2e = cvt_fp16_to_fp32(tsrc2.row[k].fp16[2*n+0])
```

```
      s1o = cvt_fp16_to_fp32(tsrc1.row[k].fp16[2*m+1])
```

```
      s2o = cvt_fp16_to_fp32(tsrc2.row[k].fp16[2*n+1])
```

```
      // FP32 FMA with DAZ=FTZ=1, RNE rounding. MXCSR is neither
```

```
      // consulted nor updated. No exceptions raised or denoted.
```

```
      temp1.fp32[2*n+0] = fma32(temp1.fp32[2*n+0], s1e, s2e, daz=1, ftz=1, sae=1, rc=RNE)
```

```
      temp1.fp32[2*n+1] = fma32(temp1.fp32[2*n+1], s1o, s2o, daz=1, ftz=1, sae=1, rc=RNE)
```

```
    for n in 0 ... Elements_dest-1:
```

```
      // FP32 add with DAZ=FTZ=1, RNE rounding. MXCSR is neither
```

```
      // consulted nor updated. No exceptions raised or denoted.
```

```
      tmpf32 := temp1.fp32[2*n+0] + temp1.fp32[2*n+1]
```

```
      tsrcdest.row[m].fp32[n] := srcdest.row[m].fp32[n] + tmpf32
```

```
      write_row_and_zero(tsrcdest, m, tmp, tsrcdest.colsb)
```

```
zero_upper_rows(tsrcdest, tsrcdest.rows)
```

```
zero_tileconfig_start()
```

**Flags Affected**

None.

**Exceptions**

AMX-E10; see Section 3.6, “Exception Classes” for details.

## TTMMULTF32PS—Matrix Transpose and Multiplication of TF32 Tiles into Packed Single Precision Tile

Opcode/ Instruction	Op/ En	64/32 bit Mode Support	CPUID Feature Flag	Description
VEX.128.NP.OF38.WO 48 11:rrr:bbb TTMMULTF32PS tmm1, tmm2, tmm3	A	V/N.E.	AMX-TRANPOSE AND AMX-TF32	Matrix multiply single precision elements converted to TF32 from transposed tmm2 and tmm3, and accumulate the packed single precision elements in tmm1.

### Instruction Operand Encoding

Op/En	Tuple	Operand 1	Operand 2	Operand 3	Operand 4
A	N/A	ModRM:reg (r, w)	ModRM:r/m (r)	VEX.vvvv (r)	N/A

### Description

This instruction performs matrix multiplication of a transposed tile with another tile containing single precision elements converted to TF32 and accumulates the results into a packed single precision tile. For each possible combination of (transposed column of tmm2, column of tmm3), the instruction performs a convert to TF32, multiply and then accumulates the result into the corresponding row and column of tmm1.

Any attempt to execute the TTMMULTF32PS instruction inside an Intel TSX transaction will result in a transaction abort.

### Operation

#### TTMMULTF32PS tsrcdest, tsrc1, tsrc2

// C = M x N (tsrcdest), A = K x M (tsrc1), B = K x N (tsrc2)

// tsrc1 and tsrc2 elements are fp32

elements\_dest:= tsrcdest.colsb/4

elements\_temp:= tsrcdest.colsb/4

for m in 0 ... tsrcdest.rows-1

temp1[0 ... elements\_temp-1] := 0

for k in 0 ... tsrc1.rows-1:

for n in 0 ... elements\_dest-1:

a1e := silence\_snan\_fp32(tsrc1.row[k].fp32[m])

a2e := silence\_snan\_fp32(tsrc2.row[k].fp32[n])

s1e := zero\_lower\_mantissa\_bits\_fp32(a1e)

s2e := zero\_lower\_mantissa\_bits\_fp32(a2e)

// FP32 FMA with DAZ=FTZ=1, RNE rounding. MXCSR is neither

// consulted nor updated. No exceptions raised or denoted.

temp1.fp32[n] := fma32(temp1.fp32[n], s1e, s2e, daz=1, ftz=1, sae=1, rc=RNE)

for n in 0 ... elements\_dest-1:

// FP32 add with DAZ=FTZ=1, RNE rounding. MXCSR is neither

// consulted nor updated. No exceptions raised or denoted.

tsrcdest.row[m].fp32[n] := tsrcdest.row[m].fp32[n] + temp1.fp32[n]

write\_row\_and\_zero(tsrcdest, m, tmp, tsrcdest.colsb)

zero\_upper\_rows(tsrcdest, tsrcdest.rows)

zero\_tileconfig\_start()



**Flags Affected**

None.

**Exceptions**

AMX-E10; see Section 3.6, “Exception Classes” for details.

## TTRANPOSED—Matrix Transpose of 32-Bit Elements

Opcode/ Instruction	Op/ En	64/32 bit Mode Support	CPUID Feature Flag	Description
VEX.128.F3.0F38.W0 5F 11:rrr:bbb TTRANPOSED tmm1, tmm2	A	V/N.E.	AMX-TRANPOSE	Transpose dword from tmm2 and write the result into tmm1.

### Instruction Operand Encoding

Op/En	Tuple	Operand 1	Operand 2	Operand 3	Operand 4
A	N/A	ModRM:reg (w)	ModRM:r/m (r)	N/A	N/A

### Description

This instruction transposes 32-bit elements from tmm2 and writes the result to tmm1. This instruction has two tile operands, one source operand, and one destination operand.

Any attempt to execute the TTRANPOSED instruction inside an Intel TSX transaction will result in a transaction abort.

### Operation

```

for i in 0 ... tdest.rows-1:
  for j in 0 ... tdest.colsb/4-1:
    tmp.dword[j] := tsrc.row[j].dword[i]
    write_row_and_zero(tdest,i,tmp,tdest.colsb)
zero_upper_rows(tdest,tdest.rows)
zero_tileconfig_start()

```

### Flags Affected

None.

### Exceptions

AMX-E9; see Section 3.6, “Exception Classes” for details.

Intel® Resource Director Technology (Intel® RDT) provides several monitoring and control capabilities for shared resources in multiprocessor systems. This chapter covers updates to the Cache Bandwidth Allocation feature of Intel RDT.

Previous versions of this document contained additional information on Intel RDT. This information, along with more details on RDT-specific terminology and usage guidelines, can now be found in the Intel® 64 and IA-32 Architectures Software Developer's Manual, Volume 3B, as well as in a new document titled "Intel® Resource Director Technology Architecture Specification," available here: <https://cdrdv2.intel.com/v1/dl/getContent/789566>.

## 4.1 CACHE BANDWIDTH ALLOCATION (CBA)

### 4.1.1 Introduction to Cache Bandwidth Allocation

The Cache Bandwidth Allocation (CBA) feature provides control over bandwidth available between Level 1 (L1) caches, Level 2 (L2) Caches, and Level 3 (L3) Caches (as applicable) for each of the logical processors. Since reducing upstream bandwidth can also reduce bandwidth to external memory, this also provides an indirect control of memory bandwidth. The CBA feature, along with the MBA, provides a mechanism to control the bandwidth of different applications.

A given CLOS used for L3 CAT, for instance, means the same thing as a CLOS used for CBA. Infrastructure such as the MSR used to associate a logical processor with a CLOS (the IA32\_PQR\_ASSOC\_MSR) and some elements of the CPUID enumeration (such as CPUID leaf 10H (Cache Allocation Technology Enumeration Leaf)) are shared. For more information, refer to the "Intel® Resource Director Technology Architecture Specification."

The following sections describe the CPUID enumeration and configuration interfaces (Model-Specific Registers) applicable to the Cache Bandwidth Allocation feature.

### 4.1.2 Cache Bandwidth Allocation Enumeration

As with certain other Intel RDT features, enumeration of the presence and details of the CBA feature is provided via a sub-leaf of the CPUID instruction.

Key components of the enumeration include support for the CBA feature on the processor, and if CBA is supported, the following details:

- Number of supported Classes of Service for the processor.
- Scope of the CBA feature MSRs.
- The maximum CBA throttle Level supported.
- An indication of whether the throttle values that can be programmed are linearly spaced or not.

The presence of any of the Intel RDT features that enable control over shared platform resources is enumerated by executing CPUID instruction with EAX = 07H and ECX = 0H as input. If CPUID.(EAX=07H, ECX=0H):EBX.PQE[bit 15] reports 1, the processor supports software control over shared processor resources. Software may then use CPUID leaf 10H to enumerate additional details on the specific controls provided.

Using CPUID leaf 10H, software may determine whether CBA is supported on the platform. Specifically, as shown in Figure 17-31, bit 5 of the EBX register indicates whether CBA is supported on the processor, and the bit position (5) constitutes a Resource ID (ResID), which allows the enumeration of CBA details. For instance, if bit 5 is supported, this implies the presence of CPUID.10H.[ResID=5] as shown in CPUID.(EAX=10H, ECX=5H), CBA Feature Details Identification, which provides the following details (this information can also be found in Table 1-3, "Information Returned by CPUID Instruction"):

- CPUID.(EAX=10H, ECX=ResID=5):EAX
  - EAX[7:0] reports the maximum CBA throttling value supported.
  - EAX[11:8] reports the scope of CBA IA32\_QoS\_Core\_BW\_Thrtl\_n MSRs. If EAX[11:8]=1, this indicates the logical processor scope of the MSRs.
  - EAX[31:12] is reserved.
- CPUID.(EAX=10H, ECX=ResID=5):EBX
  - EBX[31:0] is reserved.
- CPUID.(EAX=10H, ECX=ResID=5):ECX
  - ECX[3] reports whether the response of the bandwidth control is approximately linear. If ECX[3] is 1, the response of the bandwidth control is approximately linear. If ECX[3] is 0, the response of the bandwidth control is non-linear.
  - ECX[2:0] and ECX[31:4] are reserved.
- CPUID.(EAX=10H, ECX=ResID=5):EDX
  - EDX[15:0] reports the number of Classes of Service supported for the feature. Add one to the return value to get the result. For instance, a reported value of 15 implies a maximum of 16 supported CBA CLOS.
  - EDX[31:16] is reserved.

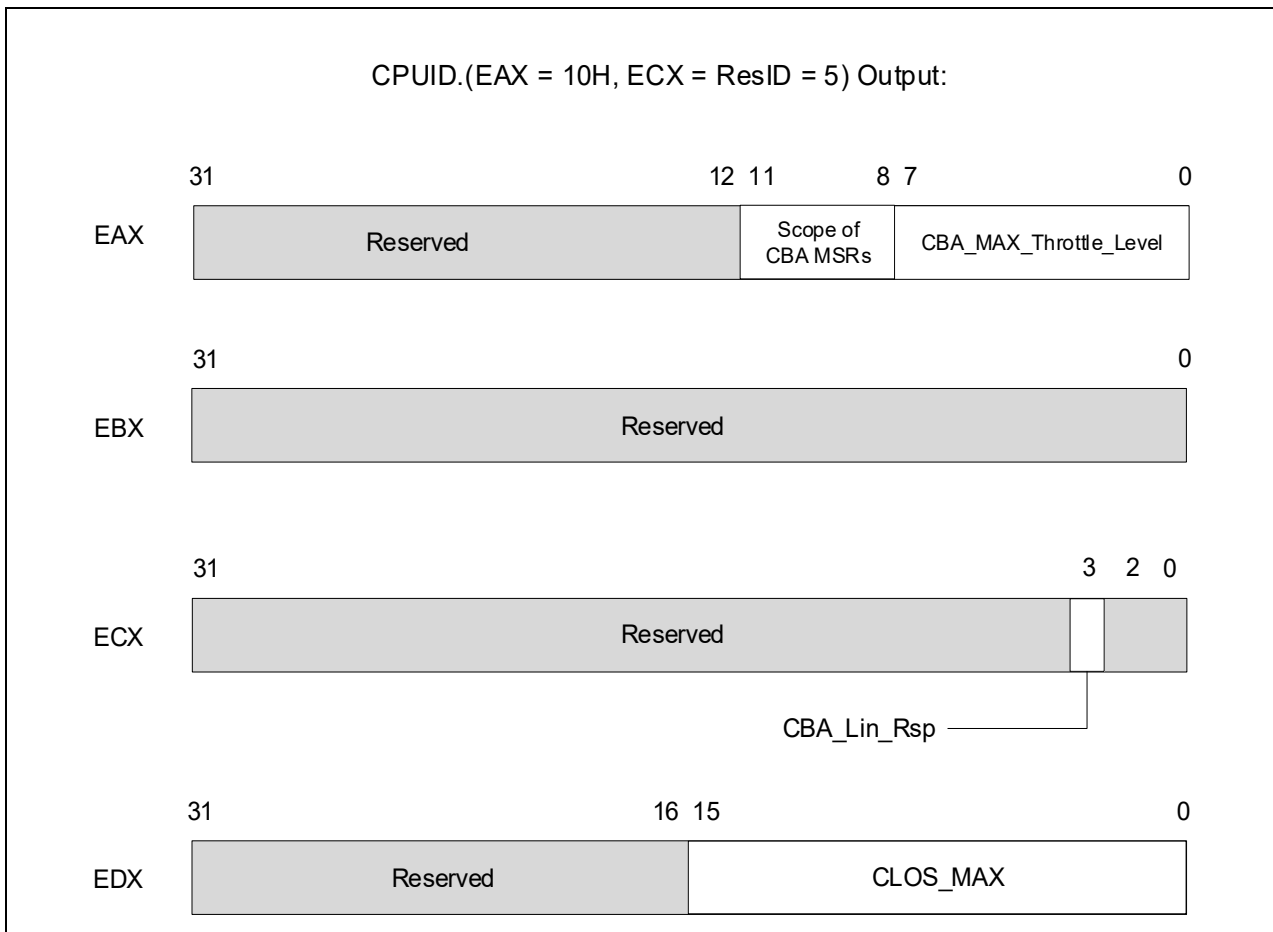

**Figure 4-1. CPUID.(EAS=10H, ECX=5H), CBA Feature Details Identification**

### 4.1.3 Cache Bandwidth Allocation Configuration

The configuration of CBA consists of two processes once enumeration is complete:

- The association of logical processors to Classes of Service (CLOS) is accomplished commonly across Intel RDT features through the IA32\_PQR\_ASSOC MSR. Software may update the CLOS field of the PQR MSR dynamically, including at context swap time, to maintain the proper association of logical processors to Classes of Service on the hardware.
- A new set of architectural MSRs is added to enable software to communicate the memory bandwidth QoS requirements of the application running on the logical processor. The scope of these MSRs, IA32\_QoS\_Core\_BW\_Thrtl\_n, is per logical processor. Each MSR encodes packed 8-bit fields indexed by Class of Service, which specify the Throttle Level for each CLOS.

The CLOS field value of the IA32\_PQR\_ASSOC MSR is used to index into the MSRs and select the software-specified Throttle Level. Each logical processor uses this level to control the bandwidth across the cache hierarchy. The hardware ensures coordination with the MBA feature (where present). The reset value of the CLOS[i].Level=0 indicates unthrottled bandwidth. This field may be programmed from 0 to CBA\_MAX\_Throttle\_Level (see Figure 4-1). Any values outside this range will generate a #GP(0). A higher value of CLOS[i].Level implies a higher level of bandwidth throttling, and a lower number indicates lesser throttling. The number of supported CLOS for a given logical processor is enumerated in CPUID.(EAX=10H, ECX=5H):EDX. In an example where a logical processor supports 16 CLOS, two 64-bit MSRs with packed Throttling Levels (TLs) are defined, IA32\_QoS\_Core\_BW\_Thrtl\_0 (defining packed TLs for CLOS[7:0]) and IA32\_QoS\_Core\_BW\_Thrtl\_1 (defining TLs for CLOS[15:8]). For example, within the MSR IA32\_QoS\_Core\_BW\_Thrtl\_0, bits [7:0] define the TL field for CLOS 0 (see Figure 4-2).

Advanced versions of the MBA feature may manage the external memory bandwidth associated with the CLOS by dynamically increasing or decreasing the bandwidth, under software guidance, to maintain throttling priorities while maximizing system performance as described in the Intel Software Developer's Manual and the Intel RDT Architecture Specification. The CBA feature, along with the MBA, provides a mechanism to control the bandwidth of different applications. Software should understand that the effective throttling of an application may be whichever of the CBA or MBA specifies more throttling. Software may use CBA, MBA, or a combination to achieve bandwidth and performance management goals if supported on a processor.

**Table 4-1. Cache Bandwidth Allocation (CBA) MSRs**

Delay Value MSR	Address
IA32_QoS_Core_BW_Thrtl_0	E00H
IA32_QoS_Core_BW_Thrtl_1	E01H
IA32_QoS_Core_BW_Thrtl_2	E02H
...	...
IA32_QoS_Core_BW_Thrtl_'(((COS_MAX+1)/8) - 1)'	E00H + (((COS_MAX from CPUID.10H.5 + 1)/8) - 1)

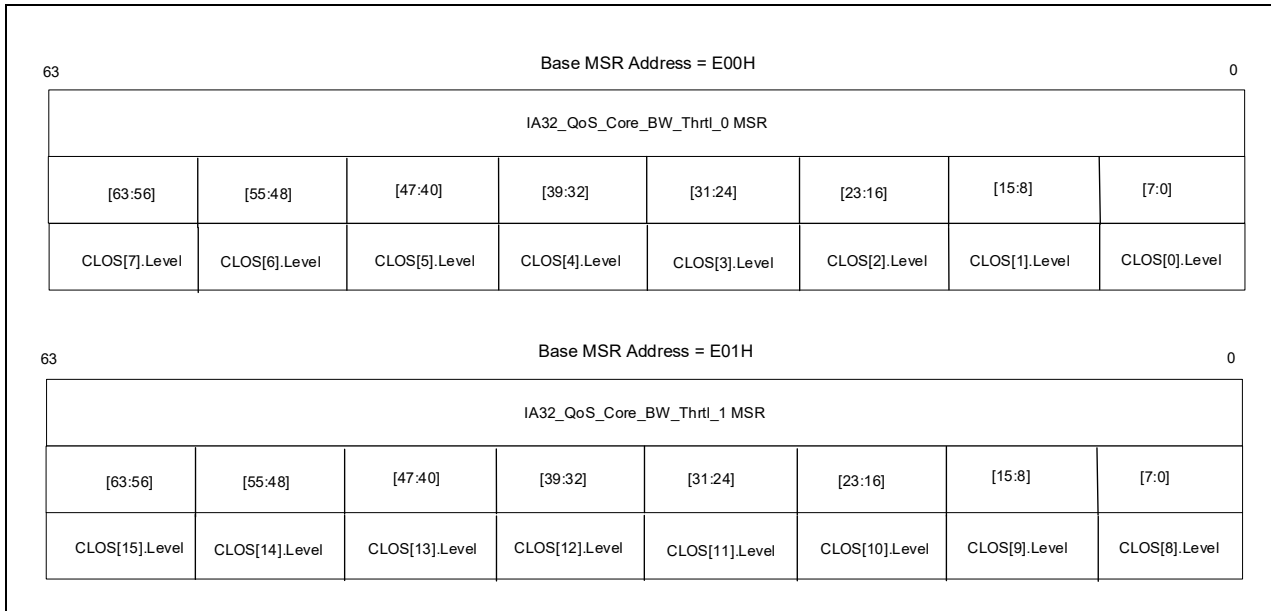

**Figure 4-2. IA32\_QoS\_Core\_BW\_Thrtl\_n MSR Definition**

Note that the throttling values provided to the software are calibrated through specific traffic patterns; however, as workload characteristics may vary, the response precision and linearity of the bandwidth threshold values will vary across products and should be treated as approximate values only.

#### 4.1.4 Cache Bandwidth Allocation Usage Considerations

Cache Bandwidth Allocation has various software usage considerations and improves efficiency over product generations. See the “Intel® Resource Director Technology Architecture Specification” for additional details.

## 4.2 MEMORY REGIONS

A Memory Region is defined as comprising one or more physical-addressed memory ranges. Certain processors support a system-level enumeration of Memory Regions. Multiple Memory Regions may be defined by the platform to independently describe physical addresses backed by a particular type of memory, which may exhibit varying capacity, latency, bandwidth, and locality characteristics. Examples include DRAM or CXL attached memories, whether attached locally or to a different processor over a coherent interconnect link. The Memory Regions populated on a particular processor are described by the system BIOS in the ACPI Memory Range and Region Mapping (MRRM) table. See the “Intel® Resource Director Technology Architecture Specification” for additional details.

For a modern platform, it becomes important for the processor to directly measure and allocate memory bandwidth across these multiple memory regions simultaneously. Such processor capabilities, when enabled, allow software to gather usage telemetry, adjust Memory Bandwidth Allocation (MBA) policies, and build control loops to ensure performance goals are met. As described below, Intel provides these capabilities as Region Aware Memory Bandwidth Monitoring and Allocation

## 4.3 REGION AWARE MEMORY BANDWIDTH MONITORING (MBM)

The Region Aware Memory Bandwidth Monitoring (MBM) feature provides a set of counters simultaneously indexed by Resource Monitoring ID (RMID) and Region to measure the memory bandwidth utilization of an RDT RMID to a Memory Region in the system. The RDT RMID is typically mapped to software threads, applications, containers or virtual machines. Typical hardware feature support for Region Aware MBM includes the ability to independently

track many RMIDs simultaneously accessing several Memory Regions. Software may consult the Enhanced Resource Director Technology (ERDT) ACPI table for enumeration of specific capabilities of this feature on a given processor generation. The ERDT table provides information regarding capabilities, SoC topology mappings to the scope of specific RDT features, Region Aware MBM MMIO interface register locations, and architectural parameters such as the number of RMIDs supported. See the “Intel® Resource Director Technology Architecture Specification” for additional details.

## 4.4 REGION AWARE MEMORY BANDWIDTH ALLOCATION (MBA)

Region Aware Memory Bandwidth Allocation (MBA) for CPU Agents extends the existing third-generation (per-Agent throttling) MBA capabilities to include Region Aware bandwidth controls per RDT Class of Service (CLOS). The Memory Region definitions used for Region Aware MBM and MBA are shared across the features, as specified in the ACPI MRRM table, allowing simultaneous and consistent monitoring and allocation of memory bandwidth. Independent throttling of per-CLOS bandwidth to multiple regions is supported, allowing software to dynamically rebalance bandwidth throttling limits across different Memory Regions, which may have varying bandwidth, latency and capacity characteristics. Example uses include rebalancing bandwidth between VMs of different priority across a shared coherent interprocessor interconnect under the direction of a software control loop or rebalancing bandwidth for threads of varying priorities across DRAM or CXL-backed memories. See Figure 4-3 for a high-level overview of Region Aware MBA. See the “Intel® Resource Director Technology Architecture Specification” for additional details.

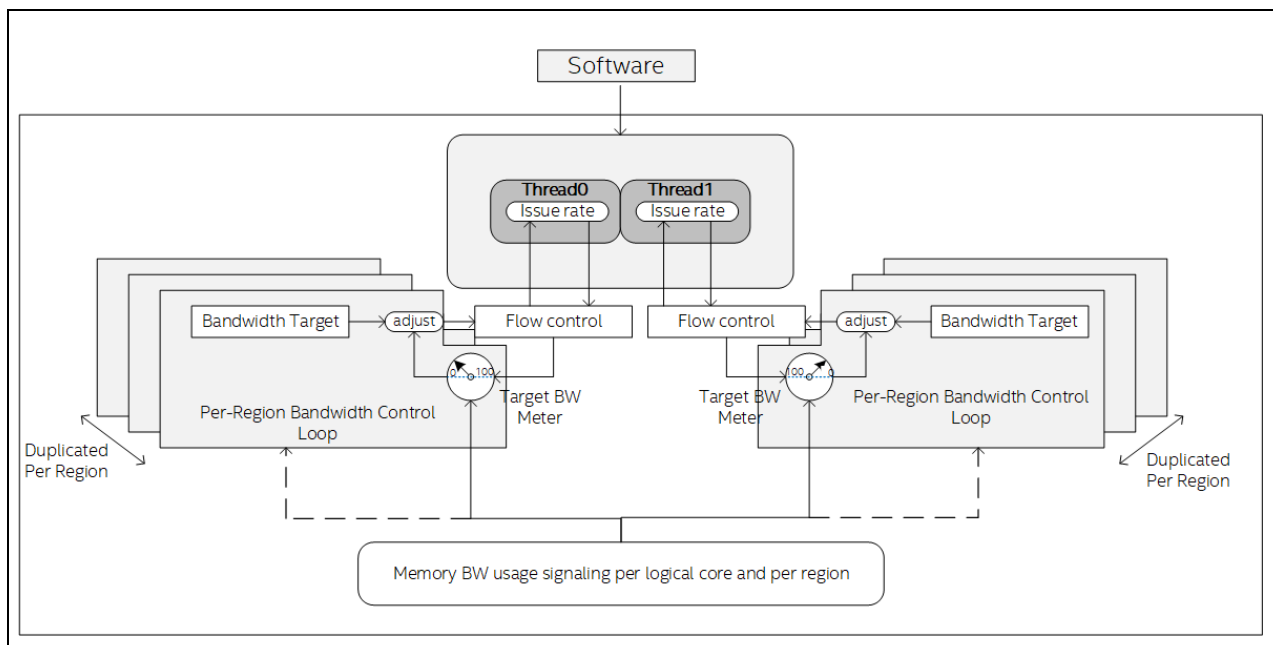

Figure 4-3. Region Aware Memory Bandwidth Allocation (MBA)

## 4.5 USE OF RDT TAGS BY OTHER FEATURES

Other features may utilize RDT tags, such as Resource Monitoring IDs, to track and report other telemetry events in the processor. Examples include per-RMID telemetry available both in-band and out-of-band as specified in the Intel® Platform Monitoring Technology (Intel® PMT) specification and associated platform-specific telemetry events lists.

## 4.6 ASYMMETRICAL ENUMERATION OF INTEL® RDT FEATURES

The enumeration of RDT has been extended to platforms that enumerate asymmetrical resources. For example, hybrid platforms (supporting multiple processor types) may contain multiple last-level caches (LLCs) with different capabilities, or some processors may not include an LLC at the same enumeration level. Software should consider the following changes to RDT enumeration to enable full RDT capabilities across all platforms. Asymmetrical RDT CPUID leaves 27H and 28H may enumerate distinct capabilities between logical processors on the platform, while CPUID RDT leaves 0FH and 10H may enumerate the common set of capabilities to ensure software compatibility. Asymmetrical RDT CPUID leaves should be enumerated per logical processor to identify differences in capabilities.

The enumeration of RDT technologies first consists of the following four CPUID leaf 07H bits in Table 4-2 and the corresponding CPUID leaves in Table 4-3.

**Table 4-2. Asymmetrical Enumeration**

CPUID Enumeration	Field Name	Description
CPUID.(EAX=07H,ECX=00H):EBX.RDT-M[bit 12]	RDT-M	Specifies that the RDT-M symmetrical enumeration is available on all logical processors.
CPUID.(EAX=07H,ECX=00H):EBX.RDT-A[bit 15]	RDT-A	Specifies that the RDT-A symmetrical enumeration is available on all logical processors.
CPUID.(EAX=07H,ECX=00H):ECX.Asymmetric RDT-M[bit 0]	Asymmetric RDT-M	Specifies that logical processors on this platform may support RDT-M; but is not guaranteed.
CPUID.(EAX=07H,ECX=00H):ECX.Asymmetric RDT-A[bit 1]	Asymmetric RDT-A	Specifies that logical processors on this platform may support RDT-A; but is not guaranteed.

**Table 4-3. Asymmetrical CPUID Leaves**

CPUID Enumeration	CPUID Leaf	Description
CPUID.(EAX=07H,ECX=00H):EBX.RDT-M[bit 12]	Leaf 0FH	This leaf provides the same values regardless of the logical processor querying leaf 0FH.
CPUID.(EAX=07H,ECX=00H):EBX.RDT-A[15]	Leaf 10H	This leaf provides the same values regardless of the logical processor querying leaf 10H.
CPUID.(EAX=07H,ECX=00H):ECX.Asymmetric RDT-M[bit 0]	Leaf 27H	This leaf can return different values between logical processors querying leaf 27H.
CPUID.(EAX=07H,ECX=00H):ECX.Asymmetric RDT-A[bit 1]	Leaf 28H	This leaf can return different values between logical processors querying leaf 28H.

The Asymmetrical RDT-M leaf 27H and subleaves have the same definitions as RDT-M leaf 0FH. The Asymmetrical RDT-A leaf 28H and subleaves have the same definitions as RDT-A leaf 10H. Symmetrical platforms may enumerate the existence of asymmetrical leaves, and therefore cannot be used to determine a system is asymmetrical.

The data provided in the asymmetrical leaves 27H and 28H are supersets of leaves 0FH and 10H. The enumeration and capabilities returned through these leaves can be any of the following:

1. Enumerating either leaves 27H or 28H is not indicative that leaves 0FH or 10H would be supported.
2. Leaves 0FH and/or 10H may return a smaller subset than the intersection of features across resources where either leaves 27H or 28H exist on a platform.
3. Leaves 0FH and/or 10H may return the intersection of features across resources where either leaves 27H or 28H exist on a platform.
4. Leaves 0FH and/or 10H may be enumerated but contain no information where either leaves 27H or 28H exist on a platform.

The enumeration provided in leaves 0FH and 10H do not have a requirement to provide resource feature information on a platform where leaves 27H or 28H exist.



Software should use the following algorithm to detect support of Intel® RDT Monitoring:

```
IF CPUID.(EAX=07H,ECX=01H):ECX.Asymmetrical RDT-M[Bit 0] = 1 THEN
    // Perform asymmetrical enumeration using leaf 27H
ELSE IF CPUID.(EAX=07H,ECX=01H):EBX.RDT-M[Bit 12] = 1 THEN
    // Perform symmetrical enumeration using leaf 0FH
ELSE
    // Intel® Resource Directory Technology Monitoring is not supported.
ENDIF
ENDIF
```

Software should use the algorithm below to detect support of Intel® RDT Allocation:

```
IF CPUID.(EAX=07H,ECX=01H):ECX.Asymmetrical RDT-A[Bit 1] = 1 THEN
    // Perform asymmetrical enumeration using leaf 28H
ELSE IF CPUID.(EAX=07H,ECX=01H):EBX.RDT-A[Bit 15] = 1 THEN
    // Perform symmetrical enumeration using leaf 10H
ELSE
    // Intel® Resource Directory Technology Allocation is not supported.
ENDIF
ENDIF
```

The asymmetrical leaves are required to be read on each logical processor. Software may determine the intersection of features across all logical processors, or software may group logical processors with matching feature sets. Logical processors that share a resource will report the same feature support for that resource. An example would be to enumerate each set of logical processors sharing an L3 cache, reading CPUID leaf 28H for L3 CAT on one logical processor sharing each L3 cache and applying those settings to all logical processors sharing the same L3 cache.

# REMOTE ATOMIC OPERATIONS IN INTEL ARCHITECTURE

## 5.1 INTRODUCTION

Remote Atomic Operations (RAO) are a set of instructions to improve synchronization performance. RAO is especially useful in multiprocessor applications that have a set of characteristics commonly found together:

- A need to update, i.e., read and modify, one or more variables atomically, e.g., because multiple processors may attempt to update the same variable simultaneously.
- Updates are not expected to be interleaved with other reads or writes of the variables.
- The order in which the updates happen is unimportant.

One example of this scenario is a multiprocessor histogram computation, where multiple processors cooperate to compute a shared histogram, which is then used in the next phase of computation. This is described in more detail in Section 5.8.1.

RAO instructions aim to provide high performance in this scenario by:

- Atomically updating memory without returning any information to the processor itself.
- Relaxing the ordering of RAO instructions with respect to other updates or writes to the variables.

RAO instructions are defined such that, unlike conventional atomics (e.g., LOCK ADD), their operations may be performed closer to memory, such as at a shared cache or memory controller. Performing operations closer to memory reduces or even eliminates movement of data between memory and the processor executing the instruction. They also have weaker ordering guarantees than conventional atomics. This facilitates execution closer to memory, and can also lead to reduced stalls in the processor pipeline. These properties mean that using RAO instead of conventional atomics may provide a significant performance boost for the scenario outlined above.

## 5.2 INSTRUCTIONS

The current set of RAO instructions can be found in Chapter 2, “Instruction Set Reference, A-Z.” These instructions include integer addition and bitwise AND, OR, and XOR. These operations may be performed on 32-bit (doubleword) or 64-bit (quadword) data elements. The destination, which is also one of the inputs, is always a location in memory. The other input is a general-purpose register, *ry*, in Table 5-1. The instructions do not change any registers or flags.

**Table 5-1. RAO Instructions**

Instruction	Operation	Function	Data Types
AADD	Atomic addition	mem = mem + ry	Doubleword, quadword
AAND	Atomic bitwise AND	mem = mem AND ry	Doubleword, quadword
AOR	Atomic bitwise OR	mem = mem OR ry	Doubleword, quadword
AXOR	Atomic bitwise XOR	mem = mem XOR ry	Doubleword, quadword

## 5.3 ALIGNMENT REQUIREMENTS

The memory location updated by an RAO instruction must be naturally aligned. That is, a doubleword update must be four-byte aligned and a quadword update must be eight-byte aligned. This facilitates implementations closer to memory; otherwise, a single update may straddle a cache line boundary.

## 5.4 MEMORY ORDERING

RAO instructions have weaker memory ordering guarantees than conventional atomic instructions. Thus, other instructions are not ordered with respect to RAO instructions as they are with conventional atomics.

More specifically, the memory operations from RAO instructions follow the Write Combining (WC) memory protocol. From software's point of view, they behave similarly to non-temporal stores. Unlike non-temporal stores, RAO instructions update a memory location, i.e., use the value in that location as an input, rather than overwrite the current contents. Another critical difference is that with RAO, the memory location may be cached upon completion of the instruction.

RAO instructions are not reordered with other memory accesses to the same memory location. That is, reads, writes, and RAO instructions to the same location by the same processor will execute in program order.

However, RAO instructions may be reordered with certain memory accesses to other memory locations. In particular, RAO instructions may be reordered with writes or RAO instructions to other memory locations. This means, for example, that if a processor executes a set of RAO instructions to a set of distinct addresses, those instructions may appear to update memory in any order.

If a stronger ordering is required, software should use a fencing operation such as those implemented by the LFENCE, SFENCE, and MFENCE instructions. However, note that RAO instructions are not ordered with respect to younger LFENCE instructions since they do not load data from memory into the processor.

## 5.5 MEMORY TYPE

RAO instructions are restricted to operating on Write Back (WB) memory. Other memory types place restrictions on the writing of and/or cacheability of data, which conflicts with RAO instructions' ability to cache data. Use of an RAO instruction to access non-WB memory results in a general-protection exception (#GP).

## 5.6 WHEN MULTIPLE RAO MEMORY OPERATIONS ARE COMBINED

Processor implementations may combine multiple RAO memory operations before execution to increase their throughput. Such implementations that combine RAO instructions take advantage of spatial locality, i.e., that a cache line contains multiple data elements, and that separate instructions may update distinct elements in a given cache line.

*Note*, implementations may have restrictions on which RAO operations can be combined. For example, they may only be able to combine operations doing the same type of update (e.g., addition) and/or the same data element size. Lastly, RAO operations to the same cache line that are not combined must be serialized by the processor implementation; this could hurt performance. Therefore, as a general rule for good performance across processor implementations, if multiple RAO operations to the same cache line are of different types, data sizes, or to the same memory location, software should increase the execution distance between such RAO operations when possible.

## 5.7 PERFORMANCE EXPECTATIONS

RAO instructions are expected to provide higher performance than conventional atomics under certain conditions. The actual performance depends on both the implementation and the data access pattern for the memory location (at the cache line granularity) updated with RAO instructions.

### 5.7.1 Interaction Between RAO and Other Accesses

As discussed in Section 5.4, weak ordering allows RAO instructions to be reordered with respect to other memory operations. This is a key difference from conventional atomics, which follow strong memory ordering, and can allow a processor to execute RAO instructions with higher throughput. However, only certain reordering is allowed. If a fence is used to enforce stronger ordering, or if a processor interleaves RAO updates with reads of the same memory location, for example, this may result in serialized accesses, and hurt performance. If software performs

an RAO update to a memory location, and soon after reads that memory location, then the read needs to wait for the update to complete. If the RAO is done close to memory, then the cache closest to the processor may not hold a copy of the cache line after the RAO instruction executes, and the read may need to access a cache farther away from the processor, or even go all the way to memory.

Mixing of RAO updates to a given memory location from one or more processors with non-RAO accesses to the same memory location can also reduce the benefits of RAO. Implementations that perform RAO updates close to memory can reduce data movement between a series of RAO updates to the same location. However, a non-RAO access may cause a processor to cache the data close to itself; a subsequent RAO instruction from another processor may require the line to be moved to a lower level of the cache hierarchy. Therefore, interleaving RAO and non-RAO accesses to a given memory location can reduce or eliminate the data movement and/or performance benefits of RAO.

### 5.7.2 Updates of Contended Data

Contended data is defined as data for which the memory system has memory accesses from multiple processors in-flight simultaneously. That is, for contended data, the memory system is at some point in time handling at least two accesses from different processors. Contended read-only data does not present a fundamental performance problem, but if at least one of the contending processors attempts to write the data, e.g., perform an update on it, the writer needs exclusive access to the data. Gaining exclusive access can be costly, in terms of latency and traffic; in a system with caches, hardware must invalidate all other copies of the data to provide a processor exclusive access.

For software performing a set of contended updates to a memory location with conventional atomic instructions, data may “ping-pong” between processors. As each processor executes its update, it will obtain exclusive access to the data, perform its update, and then have to send its new version of the data to the next processor wanting to update it. The time to pass data from one processor to another, and the time that a processor takes to perform its atomic update, limits the throughput in this scenario.

In contrast, if software uses RAO for such contended updates, and if the implementation performs the updates in a central location such as a shared cache or at the memory controller, then this bottleneck is alleviated. In such a scenario, each update will not have to fetch the current contents of the memory location or invalidate any other copies of the data because the only valid copy is already at the hardware performing the update. The only fundamental limit to the throughput in this case is the time taken for each update. Therefore, we may expect that for updates to contended lines, throughput is much higher with RAO. Further, reducing data movement means reducing traffic between processors and memory. This may improve the performance of other memory accesses.

### 5.7.3 Updates of Uncontended Data

In contrast to contended data, uncontended data is data that is accessed by only a single processor or by multiple processors, but far enough apart in time that at most a single memory access is executed at a time.

For uncontended data accessed by multiple processors, most of the above discussion about contended data still applies. However, the frequency of updates is by definition lower for uncontended data. Therefore, the performance benefits of RAO are expected to be lower in this situation.

For data accessed by only a single processor, data movement between processors is not an issue, and conventional atomics can take advantage of the processor's caches. Performance may still be impacted by the strong ordering of conventional atomics; memory accesses to other memory locations may not be reordered with these instructions. If software uses RAO instructions instead, the weaker ordering may provide some performance benefits. However, if an implementation performs RAO updates closer to memory, it may not take advantage of all of the processor's caches, and may even require removing the data from some of those caches. This could lead to an increase in data movement, and potentially lower performance. Of course, if software is aware that only a single processor will access the data, then it does not need to use atomic updates, but it may not always be so aware.

## 5.8 EXAMPLES

### 5.8.1 Histogram

Histogram is a common computational pattern, including in multiprocessor programming, but achieving an efficient parallel implementation can be tricky. In a conventional histogram computation, software sweeps over a set of input values; it maps each input value to a histogram bin, and increments that bin.

Common multiprocessor histogram implementations partition the inputs across the processors, so each processor works on a subset of the inputs. Straightforward implementations have each processor directly update the shared histogram. To ensure correctness, since multiple processors may attempt updates to the same histogram bin simultaneously, the updates must use atomics. As described above, using conventional atomics can be expensive, especially when we have highly contended cache lines in the histogram. That may occur for small histograms or for histograms where many inputs map to a small number of histogram bins.

A common alternative approach uses a technique called privatization, where each processor gets its own “local” histogram; as each processor works on its subset of the inputs, it updates its local histogram. As a final “extra” step, software must accumulate the local histograms into the globally shared histogram, a step called a reduction. This reduction step is where processors synchronize and communicate; using it allows the computation of local histograms to be embarrassingly parallel and require no atomics or inter-processor communication, and can often lead to good performance. However, privatization has downsides:

- The reduction step can take a lot of time if the histogram has many bins.
- The time for a reduction is relatively constant regardless of the number of processors. As the number of processors grows, therefore, the fraction of time spent on the reduction tends to grow.
- The local histograms require extra memory, and that memory footprint grows with the number of processors.
- The reduction is an “extra” step that complicates the software.

With RAO, software can use the simpler multiprocessor algorithm and achieve reliably good performance. The following pseudo-code lists a RAO-based histogram implementation.

```
int *histogram; // "histogram" is a global histogram array

// in each processor:
double *data; // "data" is a per-processor array, holding a subset of all inputs
data = get_data(); // populate "data" values

for (size_t i = 0; i < data_size; ++i) {
    int bin = map(data[i]); // map data[i] to a histogram bin
    _aadd(&histogram[bin], 1); // RAO AADD instruction
}
```

The above code can provide good performance under various scenarios, i.e., sizes of histograms and biases in which histogram bins are updated. RAO avoids data “ping-ponging” between processors, even under high contention. Further, the weak ordering of RAO allows a series of AADD instructions to overlap with each other in the pipeline, and thus provide for instruction level parallelism.

In addition to the performance benefits, the RAO code is simple and is thus easier to maintain.

While we specifically show and discuss histogram above, this computation pattern is very common, e.g., software packet processing workloads exhibit this in how they track statistics of the packets. Other algorithms exhibiting this pattern should similarly see benefits from RAO.

### 5.8.2 Event Handler

A *user-mode* event handler, running either in a dedicated thread or preemptively in a specific processor, notifies a set of receivers (e.g., all processors or threads in a waiting list) of the occurrence of an event by atomically setting flags in the receivers' specific data fields. The example below shows how this may be done with RAO instructions.

```
// One processor sets event bits to notify other processors:
01: void handle_event(event_t *e) {
02:   uint32_t event_bits = process_event(e);
03:   for (int i = 0; i < num_of_receivers; ++i) {
04:     core_t *core = receivers[i];
05:     _aor(&core->flags, event_bits); // RAO AOR instruction
06:     if (some_condition) {
07:       _aor(&core->extra_flags, event_bits); // combining of RAO could occur
08:     } // if "extra_flags" and "flags" are in the same cache line
09:   }
10:   _mm_sfence(); // ensure event_bits are visible before leaving the handler
11: }

// In other processors:
12: if (my_core->flags & SOME_EVENT) {
13:   ..... // react to the occurrence of SOME_EVENT
14:   clear_bits(&my_core->flags, SOME_EVENT);
15: }
```

With conventional atomics (e.g., LOCK OR), a significant portion of execution time of `handle_event` would be spent accessing `core->flags` (line 5) and `core->extra_flags` (line 7). It is likely that when `handle_event` begins, the two fields are in another processor's cache, e.g., if that processor updated some bits in the fields. Therefore, the data would need to migrate to the cache of the processor executing `handle_event`.

In contrast, for the above code example, for RAO implementations that perform updates close to memory, the RAO AOR instruction should reduce data movement of `core->flags` and `core->extra_flags` and thus result in a lower execution latency. Further, when other processors later access these fields (lines 12-15), they will also benefit from a lower latency due to reduced data movement, since they may get the data from a more central location.

Also note that since the order of notifications does not matter in this case, the function further takes advantage of RAO's weak ordering, allowing multiple RAO AOR instructions to be executed concurrently. It does, however, include a memory fence at the end (line 10), to ensure that all updates are visible to all processors before leaving the handler.

# CHAPTER 6

## TOTAL STORAGE ENCRYPTION IN INTEL ARCHITECTURE

---

### 6.1 INTRODUCTION

Total Storage Encryption (TSE) is an architecture that allows encryption of storage at high speed. TSE provides the following capabilities:

- Protection (confidentiality) of data at rest in storage.
- NIST Standard AES-XTS Encryption.
- A mechanism for software to configure hardware keys (which are not software visible) or software keys.
- A consistent key interface to the crypto engine.

#### 6.1.1 Key Programming Overview

Keys for TSE can either be programmed directly in plain text or through wrapped Binary Large Objects (BLOBs).

- Direct programming: Software programs keys after reset to the TSE engine using a structure in memory. Keys may be exposed in memory.
- Wrapped BLOB programming: Wrapped-key BLOBs are generated once at provisioning time, persist across boots, and are used directly to program the TSE engine without unwrapping/recovering keys in software.

##### 6.1.1.1 Key Wrapping Support: PBNDKB

Platform Bind Key BLOB (PBNDKB) allows software to wrap secret information with a platform-specific wrapping key and bind it to the TSE engine.

#### 6.1.2 Unwrapping and Hardware Key Programming Support: PCONFIG

The PCONFIG instruction allows software to program keys to the TSE engine either directly from memory or using PBNDKB-generated wrapped BLOBs.

The PCONFIG instruction is also used to program the TME-MK engine. For additional details on the PCONFIG instruction, see Chapter 2 of this document.

### 6.2 ENUMERATION

CPUID enumerates the existence of the IA32\_TSE\_CAPABILITY MSR and the PBNDKB instruction.

The IA32\_TSE\_CAPABILITY MSR enumerates supported cryptographic algorithms and keys.

#### 6.2.1 CPUID Detection

If CPUID.(EAX=07H, ECX=1):EBX.PBNDKB[bit 1] = 1, the processor supports the IA32\_TSE\_CAPABILITY MSR and the PBNDKB instruction.

##### 6.2.1.1 PCONFIG CPUID Leaf Extended to Support Total Storage Encryption

TSE is assigned a PCONFIG target identifier. The current PCONFIG target identifiers are as follows:

- 0: Invalid Target ID
- 1: TME-MK

- 2: TSE

If TSE is supported on the platform, CPUID.PCONFIG\_LEAF will enumerate TSE as a supported target in sub-leaf 0, ECX=TSE:

- TSE\_KEY\_PROGRAM leaf is available when TSE is enumerated by PCONFIG as a target.
- TSE\_KEY\_PROGRAM\_WRAPPED is available when TSE is enumerated by PCONFIG as a target.

## 6.2.2 Total Storage Encryption Capability MSR

The TSE\_CAPABILITY MSR (9F1H) enumerates the supported capabilities of TSE. It has the fields shown in Table 6-1.

**Table 6-1. TSE Capability MSR Fields**

Bit	Description
15:0	Supported encryption algorithms (see below).
23:16	TSE Engine Key Sources Supported.
35:24	Reserved.
50:36	TSE_MAX_KEYS (Indicates the maximum number of keys that are available).
63:51	Reserved.

Bits 15:0 enumerate, as a bitmap, the encryption algorithms that are supported. As of this writing, the only supported algorithm is 256-bit AES-XTS, which is enumerated by setting bit 0.

## 6.3 VMX SUPPORT

### 6.3.1 Changes to VMCS Fields

A new execution control called “enable PBNDKB” is added to support TSE in bit 9 of the tertiary processor-based execution controls field of the VMCS. If this control is zero, then any execution of the PBNDKB instruction causes an invalid-opcode exception (#UD).

### 6.3.2 Changes to VMX Capability MSRs

Support for “enabled PBNDKB” is indicated by bit 9 of the IA32\_VMX\_PROCBASED\_CTL3 MSR (index 492H).

### 6.3.3 Changes to VM Entry

If bit 9 is clear in the IA32\_VMX\_PROCBASED\_CTL3 MSR, then VM entry fails if “enable PBNDKB” and the “activate tertiary controls” primary processor-based VM-execution control are both 1.

## 6.4 INSTRUCTION SET

See Chapter 2 for details on the PBNDKB instruction, as well as information on updates to the PCONFIG instruction.



## CHAPTER 7

# USER-TIMER EVENTS AND INTERRUPTS

---

This chapter describes an architectural feature called **user-timer events**.

The feature defines a new 64-bit value called the **user deadline**. Software may read and write the user deadline. When the user deadline is not zero, a user-timer event becomes **pending** when the logical processor's timestamp counter (TSC) is greater than or equal to the user deadline.

A pending user-timer event is processed by the processor when CPL = 3 and certain other conditions apply. When processed, the event results in a user interrupt with the **user-timer vector**. (Software may read and write the user-timer vector). Specifically, the processor sets the bit in the UIRR (user interrupt request register) corresponding to the user timer vector. The processing also clears the user deadline, ensuring that there will be no subsequent user-timer events until software writes the user deadline again.

Section 7.1 discusses the enabling and enumeration of the new feature. Section 7.2 presents details of the user deadline, and Section 7.3 explains how it (together with the user-timer vector) is represented in a new MSR. Section 7.4 explains when and how a logical processor processes a pending user-timer event. Section 7.5 presents VMX support for virtualizing the new feature.

## 7.1 ENABLING AND ENUMERATION

Processor support for user-timer events is enumerated by CPUID.(EAX=07H, ECX=1H):EDX.UTMR[bit 13]. If this feature flag is set, the processor supports user-timer events, and software can access the IA32\_UINTR\_TIMER MSR (see Section 7.3).

## 7.2 USER DEADLINE

A logical processor that supports user-timer events supports a 64-bit value called the **user deadline**. If the user deadline is non-zero, the logical processor pends a user-timer event when the timestamp counter (TSC) reaches or exceeds the user deadline.

Software can write the user deadline using instructions specified later in this chapter (see Section 7.3). The processor enforces the following:

- Writing zero to the user deadline disables user-timer events and cancels any that were pending. As a result, no user-timer event is pending after zero is written to the user deadline.
- If software writes the user deadline with a non-zero value that is less than the TSC, a user-timer event will be pending upon completion of that write.
- If software writes the user deadline with a non-zero value that is greater than that of the TSC, no user-timer event will be pending after the write until the TSC reaches the new user deadline.
- A logical processor processes a pending user-timer event under certain conditions; see Section 7.4. The logical processor clears the user deadline after pending a user-timer event.

Races may occur if software writes a new user deadline when the value of the TSC is close to that of the original user deadline. In such a case, either of the following may occur:

- The TSC may reach the original deadline before the write to the deadline, causing a user-timer event to be pended. Either of the following may occur:
  - If the user-timer event is processed before the write to the deadline, the logical processor will clear the deadline before the write. The write to the deadline may cause a second user-timer event to occur later.
  - If the write to the deadline occurs before the user-timer event is processed, the original user-timer event is canceled, and any subsequent user-timer event will be based on the new value of the deadline.

When writing to the deadline, it may not be possible for software to control with certainty which of these two situations occurs.

- The write to the deadline may occur before TSC reaches the original deadline. In this case, no user-timer event will occur based on the original deadline. Any subsequent user-timer event will be based on the new value of the deadline.

Software writes to the user deadline using a new MSR described in Section 7.3.

## 7.3 USER TIMER: ARCHITECTURAL STATE

The user-timer architecture defines a new MSR, IA32\_UINTR\_TIMER. This MSR can be accessed using MSR index 1B00H.

The IA32\_UINTR\_TIMER MSR has the following format:

- Bits 5:0 are the user-timer vector. Processing of a user-timer event results in the pending of a user interrupt with this vector (see Section 7.4).
- Bits 63:6 are the upper 56 bits of the user deadline (see Section 7.2).

Note that no bits are reserved in the MSR and that writes to the MSR will not fault due to the value of the instruction's source operand. The IA32\_UINTR\_TIMER MSR can be accessed via the following instructions: RDMSR, RDMSRLIST, URDMSR, UWRMSR, WRMSR, WRMSRLIST, and WRMSRNS.

If the IA32\_UINTR\_TIMER MSR is written with value X, the user-timer vector gets value X & 3FH; the user deadline gets value X & ~3FH.

If the user-timer vector is V ( $0 \leq V \leq 63$ ) and the user deadline is D, a read from the IA32\_UINTR\_TIMER MSR return value  $(D \& \sim 3FH) | V$ .

## 7.4 PENDING AND PROCESSING OF USER-TIMER EVENTS

There is a user-timer event pending whenever the user deadline (Section 7.2) is non-zero and is less than or equal to the value of the timestamp counter (TSC).

If CR4.UINTR = 1, a logical processor processes a pending user-timer event at an instruction boundary at which the following conditions all hold<sup>1</sup>: (1) IA32\_EFER.LMA = CS.L = 1 (the logical processor is in 64-bit mode); (2) CPL = 3; (3) UIF = 1; and (4) the logical processor is not in the shutdown state or in the wait-for-SIPI state.<sup>2</sup>

When the conditions just identified hold, the logical processor processes a user-timer event. User-timer events have priority just above that of user-interrupt delivery. If the logical processor was in a state entered using the TPAUSE and UMWAIT instructions, it first wakes up from that state and becomes active. If the logical processor was in enclave mode, it exits the enclave (via AEX) before processing the user-timer event.

The following pseudocode details the processing of a user-timer event:

```
UIRR[UserTimerVector] := 1;
recognize a pending user interrupt; // may be delivered immediately after processing
IA32_UINTR_TIMER := 0; // clears the deadline and the vector
```

Processing of a user-timer event aborts transactional execution and results in a transition to a non-transactional execution. The transactional abort loads EAX as it would have had it been due to an ordinary interrupt.

Processing of a user-timer event cannot cause a fault or a VM exit.

## 7.5 VMX SUPPORT

The VMX architecture supports virtualization of the instruction set and its system architecture. Certain extensions are needed to support virtualization of user-timer events. This section describes these extensions.

1. Execution of MOV SS, POP SS, or STI may block the processing of user-timer events for one instruction.
2. A logical processor processes a user-timer event only if CPL = 3. Since the HLT and MWAIT instructions can be executed only if CPL = 0, a user-timer event is never processed when a logical processor is an activity state that was entered using one of those instructions.

## 7.5.1 VMCS Changes

One new 64-bit VM-execution control field is defined called the **virtual user-timer control**. It can be accessed with the encoding pair 2050H/2051H. See Section 7.5.2 for its use in VMX non-root operation. This field exists only on processors that enumerate CPUID.(EAX=07H, ECX=1H):EDX[13] as 1 (see Section 7.1).

## 7.5.2 Changes to VMX Non-Root Operation

This section describes changes to VMX non-root operation for user-timer events.

### 7.5.2.1 Treatment of Accesses to the IA32\_UINTR\_TIMER MSR

As noted in Section 7.3, software can read and write the IA32\_UINTR\_TIMER MSR using certain instructions. The operation of those instructions is changed when they are executed in VMX non-root operation:

- Any read from the IA32\_UINTR\_TIMER MSR (e.g., by RDMSR) returns the value of the virtual user-timer control.
- Any write to the IA32\_UINTR\_TIMER MSR (e.g., by WRMSR) is treated as follows:
  - The source operand is written to the virtual user-timer control (updating the VMCS).
  - Bits 5:0 of the source operand are written to the user-timer vector.
  - If bits 63:6 of the source operand are zero, the user deadline (the value that actually controls when hardware generates a user time event) is cleared to 0. Section 7.2 identifies the consequences of this clearing.
  - If bits 63:6 of the source operand are not all zero, the user deadline is computed as follows. The source operand (with the low 6 bits cleared) is interpreted as a virtual user deadline. The processor converts that value to the actual user deadline based on the current configuration of TSC offsetting and TSC scaling.<sup>1</sup>
  - Following such a write, the value of the IA32\_UINTR\_TIMER MSR (e.g., as would be observed following a subsequent VM exit) is such that bits 63:6 contain the actual user deadline (not the virtual user deadline), while bits 5:0 contain the user-timer vector.

### 7.5.2.2 Treatment of User-Timer Events

The processor's treatment of user-timer events is described in Section 7.4. These events occur in VMX non-root operation under the same conditions described in that section.

The processing of user-timer events differs in VMX non-root operation only in that, in addition to clearing the IA32\_UINTR\_TIMER MSR, the processing also clears the virtual user-timer control (updating the VMCS).

## 7.5.3 Changes to VM Entries

A VM entry results in a pending user-timer event if and only if the VM entry completes with the user deadline non-zero and less than or equal to the (non-virtualized) TSC. The processor will process such an event only if indicated by the conditions identified in Section 7.4.

---

1. This conversion may not be meaningful if "RDTSC exiting" is 1. Software setting "RDTSC exiting" to 1 should ensure that any write to the IA32\_UINTR\_TIMER MSR causes a VM exit.



This chapter describes a VMX extension called **APIC-timer virtualization**.

The new feature virtualizes the TSC-deadline mode of the APIC timer. When this mode is active, software can program the APIC timer with a deadline written to the IA32\_TSC\_DEADLINE MSR. A timer interrupt becomes pending when the logical processor's timestamp counter (TSC) is greater or equal to the deadline.

APIC-timer virtualization operates in conjunction with the existing virtual-interrupt delivery feature. With that feature, a virtual-machine monitor (VMM) establishes a virtual-APIC page in memory for each virtual logical processor (vCPU). A logical processor uses this page to virtualize certain aspects of APIC operation for the vCPU.

The feature is based on new guest-timer hardware that introduces two new architectural features: **guest-timer events** and a **guest deadline**. With APIC-timer virtualization, guest writes to the IA32\_TSC\_DEADLINE MSR do not interact with the APIC (or its timer) but instead establish a guest deadline to arm the guest-timer hardware. When a logical processor's TSC is greater than or equal to the guest deadline, a guest-timer event becomes pending. Processing of a guest-timer event updates the virtual-APIC page to record the fact that a new virtual interrupt is pending.

Section 8.1 presents the new guest-timer hardware, focusing on the guest deadline and guest-timer events. Section 8.2 identifies new VMCS support (a new control and new fields). Section 8.3, Section 8.4, and Section 8.5 detail the changes to VM entries, VMX non-root operation, and VM exits, respectively.

## 8.1 GUEST-TIMER HARDWARE

A logical processor supports APIC-timer virtualization using new guest-timer hardware. Software controls this hardware using an unsigned 64-bit value called the **guest deadline**. (There is a separate guest deadline for each logical processor.) If the guest deadline is non-zero, a guest-timer event will be pending when the timestamp counter (TSC) reaches or exceeds the guest deadline.

Section 8.1.1 describes how the guest-timer hardware responds to updates to the guest deadline. Section 8.1.2 presents details of the new guest-timer events.

### 8.1.1 Responding to Guest-Deadline Updates

Subsequent sections specify the operations that modify the guest deadline. The processor enforces the following:

- Modifying the guest deadline to have value zero disables guest-timer events. After this, no guest-timer event will be pending before the next modification of the guest deadline.
- Modifying the guest deadline to have a non-zero value less than or equal to the TSC causes a guest-timer event to be pending at the next instruction boundary.
- Modifying the guest deadline to have a non-zero value greater than the TSC arms the guest timer. After this, no guest-timer event will be pending before the TSC reaches the guest deadline (unless the guest deadline is modified again). A guest-timer event will become pending when the TSC reaches the guest deadline.

Races may occur if the guest deadline is modified when the value of the TSC is close to that of the guest deadline. In such a case, either of the following may occur:

- The TSC may reach the original guest deadline before the guest deadline is modified, causing a guest-timer event to be pended. Either of the following may occur:
  - If the guest-timer event is processed before the guest deadline is modified, the logical processor will clear the deadline (as part of event processing) before the deadline is modified. The new deadline may cause a second guest-timer event to occur later.
  - If the guest deadline is modified before a guest-timer event can be processed, no guest-timer event based on the original deadline will occur, and any subsequent guest-timer event will be based on the new guest deadline.

- The guest deadline may be modified before the TSC reaches the original guest deadline. In this case, no guest-timer event will occur based on the original guest deadline, and any subsequent guest-timer event will be based on the new guest deadline.

## 8.1.2 Guest-Timer Events

A guest-timer event becomes pending when the guest deadline is non-zero and is less than or equal to the TSC.

A logical processor in the wait-for-SIPI state or the shutdown state inhibits guest-timer events.

Guest-timer events have priority just below that of external interrupts (and above that of virtual interrupts or interrupt-window exiting).

A pending guest-timer event that is not inhibited or preempted by higher-priority events is processed by the logical processor as described in Section 8.4.2.

The remainder of this chapter should make clear that the guest deadline is always zero outside VMX non-root operation and thus a guest-timer event can become pending only if in VMX non-root operation.

## 8.2 VMCS SUPPORT

Section 8.2.1 identifies a new VM-execution control to enable the APIC-timer virtualization feature. Section 8.2.2 enumerates new fields added to the VMCS to support the feature.

### 8.2.1 New VMX Control

This feature introduces a new VM-execution control called “APIC-timer virtualization.” It is tertiary processor-based VM-execution control 8.

Setting this control enables guest-timer events based on the guest deadline. See Section 8.3.2 and Section 8.4.1.

### 8.2.2 New VMCS Fields

This feature introduces three new VMCS fields:

- **Guest deadline** is a new 64-bit guest-state field. Software can access this field with VMREAD or VMWRITE using the encoding pair 2830H/2831H.
- **Guest deadline shadow** is a new 64-bit VM-execution control field. This is the guest deadline relative to the guest’s virtualized view of the TSC. See Section 8.4.1 for details. Software can access this field with VMREAD or VMWRITE using the encoding pair 204EH/204FH.
- **Virtual timer vector** is a new 16-bit VM-execution control field. The low 8 bits of this field contain the vector used for virtual timer interrupts. Software can access this field with VMREAD or VMWRITE using the encoding 000AH.

## 8.3 CHANGES TO VM ENTRIES

This section describes changes to the operation of VM entries related to this new feature. Changes include new checking of certain VMX controls (Section 8.3.1) and possible loading of the guest deadline (Section 8.3.2).

### 8.3.1 Checking VMX Controls

If the “APIC-timer virtualization” VM-execution control is 1, VM entry ensures that the following all hold:

- The “virtual-interrupt delivery” VM-execution control is 1.
- The “RDTSC exiting” VM-execution control is 0.
- The value of the virtual timer vector is at most 255.

If any of those is not the case, VM entry fails. Control is passed to the next instruction, RFLAGS.ZF is set to 1 to indicate the failure, and the VM-instruction error field is loaded with value 7, indicating “VM entry with invalid control field(s).”

(This check may be performed in any order with respect to other checks on VMX controls and the host-state area. Different processors may thus give different error numbers for the same VMCS.)

### 8.3.2 Loading the Guest Deadline

If the “APIC-timer virtualization” VM-execution control is 1, VM entry loads the guest deadline from the corresponding field in the guest-state area of the VMCS. If the value loaded is non-zero, a guest-timer event may become pending, as described in Section 8.1.1.

If the “APIC-timer virtualization” VM-execution control is 0, the guest deadline is not loaded and its value remains zero. As a result, no guest-timer event will be pending after the VM entry.

## 8.4 CHANGES TO VMX NON-ROOT OPERATION

The 1-setting of the “APIC-timer virtualization” VM-execution control changes how a logical processor responds to accesses to the IA32\_TSC\_DEADLINE MSR. These changes are described in Section 8.4.1. In addition, the 1-setting of that control may result in the processing of guest-timer events, as is detailed in Section 8.4.2.

### 8.4.1 Accesses to the IA32\_TSC\_DEADLINE MSR

If the “APIC-timer virtualization” VM-execution control is 1, the operation of reads and writes to the IA32\_TSC\_DEADLINE MSR (MSR 6E0H) is modified:

- Any read from the IA32\_TSC\_DEADLINE MSR (e.g., by RDMSR) that does not cause a fault or a VM exit returns the value of the guest deadline shadow (from the VMCS).
- Any write to the IA32\_TSC\_DEADLINE MSR (e.g., by WRMSR) that does not cause a fault or a VM exit is treated as follows:
  - The source operand is written to the guest deadline shadow (updating the VMCS).
  - If the source operand is zero, the guest deadline (the value that controls when hardware generates a guest time event) is cleared to 0.
  - If the source operand is not zero, the guest deadline is computed as follows. The source operand is interpreted as a virtual deadline. The processor converts that value to the actual guest deadline based on the current configuration of TSC offsetting and TSC scaling.

(See Section 8.1.1 for how a logical processor responds to such updates to the guest deadline.)

Note that when the “APIC-timer virtualization” VM-execution control is 1, such writes do not change the value of the IA32\_TSC\_DEADLINE MSR nor do they interact with the APIC timer in any way.

When the “APIC-timer virtualization” VM-execution control is 0, reads and writes of the IA32\_TSC\_DEADLINE MSR operate as they would on processors that do not support the new feature. In this case, there is no way to read or write the guest deadline, and it is always zero.

### 8.4.2 Processing of Guest-Timer Events

As explained in Section 8.1.2, a pending guest-timer event that is not inhibited or preempted by higher-priority events is processed by the logical processor. This section provides details of that processing.

Processing of a guest-timer event updates the virtual-APIC page to cause a virtual timer interrupt to become pending. Specifically, the logical processor performs the following steps:

```
V := virtual timer vector;
VIRR[V] := 1; // update virtual IRR field on virtual-APIC page
RVI := max{RVI, V}; // update guest interrupt status field in VMCS
evaluate pending virtual interrupts; // a virtual interrupt may be delivered immediately after this processing
Guest deadline := 0;
Guest deadline shadow := 0;
```

The following items consider certain special cases:

- If a guest-timer event is processed between iterations of a REP-prefixed instruction (after at least one iteration has completed but before all iterations have completed), the following items characterize processor state after the steps indicated above and before guest execution resumes:
  - RIP references the REP-prefixed instruction;
  - RCX, RSI, and RDI are updated to reflect the iterations completed; and
  - RFLAGS.RF = 1.
- If a guest-timer event is processed after partial execution of a gather instruction or a scatter instruction, the destination register and the mask operand are partially updated and RFLAGS.RF = 1.
- If a guest-timer event is processed while the logical processor is in the state entered by HLT, the processor returns to the HLT state after the steps indicated above (if a pending virtual interrupt was recognized, the logical processor may immediately wake from the HLT state).
- If a guest-timer event is processed while the logical processor is in the state entered by MWAIT, TPAUSE, or UMWAIT, the processor will be in the active state after the steps indicated above.
- A guest-timer event that becomes pending during transactional execution may abort the transaction and result in a transition to a non-transactional execution. If it does, the transactional abort loads EAX as it would had it been due to an interrupt.
- A guest-timer event that occurs while the logical processor is in enclave mode causes an asynchronous enclave exit (AEX) to occur before the steps indicated above.

## 8.5 CHANGES TO VM EXITS

This section describes changes to the operation of VM exits related to this new feature.

On a processor that supports the 1-setting of “APIC-timer virtualization” VM-execution control, every VM exit saves the value of the guest deadline into the corresponding field in the guest-state area of the VMCS and then clears the guest deadline to zero. This implies that, if “APIC-timer virtualization” is 0, a VM exit will overwrite the guest-deadline field in the VMCS with zero, and the previous value of that field will be lost.

Since VM exits always result in the guest deadline being zero and the guest deadline must remain zero until the next VM entry, guest-timer events are pending only VMX non-root operation (and only if the “APIC-timer virtualization” VM-execution control is 1).



## CHAPTER 9 PROCESSOR TRACE TRIGGER TRACING

This chapter documents the architecture for Processor Trace Trigger Tracing, an addition to the Intel® Processor Trace (Intel® PT) feature, which captures information about software execution. Details on the Intel PT infrastructure and control flow trace capabilities can be found in Chapter 33, "Intel® Processor Trace," of the Intel® 64 and IA-32 Architectures Software Developer's Manual, Volume 3C.

Processor Trace Trigger Tracing (PTTT) aids software in functional debug more easily by linking other features like performance monitoring counters and debug breakpoints with Processor Trace. It does this by allowing those other features to cause Processor Trace actions like generating packets or resuming/pausing tracing. This can give various benefits, from lower overhead logging of breakpoints or performance events to tracing only the desired blocks based on memory access pattern or performance activity (e.g., trace when the instructions per cycle drop below 1).

PTTT achieves this by allowing inputs like performance monitoring event increments, overflows, or debug breakpoint matches to cause a 'trigger event.' When a trigger event happens, the hardware generates a new PT packet called a TRIG packet, which contains information about the triggered event. A logical processor may implement many trigger input/action (**trigger unit**) hardware units, each of which can be independently programmed. The presence of the PTTT feature, the number of trigger units implemented in a logical processor, and their supported capabilities are enumerated using CPUID Leaf 14H.

### 9.1 PROCESSOR TRACE TRIGGER TRACING OVERVIEW

Processor support for PTTT is enumerated by CPUID.(EAX=14H, ECX=0H):EBX.PTTT[bit 9]. When this bit is set, software can query details of the supported capabilities by enumerating the CPUID.(EAX=14H, ECX=01H) subleaf. PTTT capability enumerated in CPUID Leaf 14H is consistent across all the logical processors in the system.

#### 9.1.1 Trigger Unit

The PTTT feature contains multiple trigger units. Each trigger unit can be independently configured to select the input used for the trigger and the actions to be taken by hardware when the trigger event happens. Trigger units can be configured using the trigger configuration IA32\_RTIT\_TRIGGERx\_CFG MSRs described in Section 9.2.1. Each trigger unit is configured using 16 bits in the IA32\_RTIT\_TRIGGERx\_CFG MSR. Each trigger configuration MSR allows the configuration of four trigger units. The number of IA32\_RTIT\_TRIGGERx\_CFG MSRs present in a logical processor is enumerated using CPUID.(EAX=14H, ECX=01H):EAX[10:8].

#### 9.1.2 Trigger Input

Within the 16 bits of each trigger unit, the first seven bits (e.g., [6:0], [22:16], etc.) are used to select the trigger input. Table 9-1 describes the supported trigger inputs.

**Table 9-1. Supported Trigger Inputs**

Trigger Input Encoding	Description
00H–07H	PMC[0..7] Event Increment. If IA32_PERFEVTSELx_MSR.EN_PT_LOG = 1, whenever the selected performance counter increments, it will be treated as a PT trigger event.
20H–27H	PMC[0..7] Overflow. If IA32_PERFEVTSELx_MSR.EN_PT_LOG = 1, whenever the selected performance counter overflows, it will be treated as a PT trigger event.
40H–43H	DR[0..3] Breakpoint Match. If DR7.DRx_PT_LOG = 1, whenever the selected code or data breakpoints match, it will be treated as a PT trigger event. This is supported only if CPUID.(EAX=14H, ECX=01H):ECX[15] = 1.
08H–1FH, 28H–3FH, 44H–7FH	Reserved for future use.

If the PTTT capability is detected (CPUID.(EAX=014H, ECX=0H):EBX[9] = 1), then both PMC Event Increment and PMC Overflows are supported as valid trigger inputs.

The DRx Breakpoint Match capability is enumerated by CPUID.(EAX=014H, ECX=01H):ECX[15] = 1. Only code and data breakpoint matches are supported, not I/O breakpoints. Operations that can delay a data breakpoint (MOV/POP SS) also delay the breakpoint trigger event. When a corresponding DRx\_PT\_LOG bit is set, that breakpoint will only be recognized as a trigger event (when properly enabled) and will not pend a #DB exception or trap.

Programming a reserved trigger input encoding into a trigger configuration MSR does not generate a general protection exception #GP(0), but when and whether it causes a trigger event is undefined.

### 9.1.3 Trigger Actions

Table 9-2 defines the trigger actions. A trigger input can have multiple trigger actions.

**Table 9-2. Trigger Actions**

Bit Position in Trigger Unit	Description
12	TRACE_RESUME. PT Tracing will be resumed on the trigger event when this bit is 1. This is supported only if CPUID.(ECX=14H, ECX=01H):ECX[1] = 1.
13	TRACE_PAUSE. PT Tracing will be paused on the trigger event when this bit is 1. This is supported only if CPUID.(ECX=14H, ECX=01H):ECX[1] = 1.
14	EN_ICNT. Retired instruction count information will be valid in the TRIG packet when this bit=1. This is supported only if CPUID.(EAX=14H, ECX=01H):ECX[0] = 1.
15	EN. Trigger Unit Enable. Trigger actions will only occur when this bit is 1.

When a trigger unit's configured event happens, hardware takes the requested trigger actions for the enabled trigger input. If a TRACE\_PAUSE trigger action is requested, then tracing is paused, and a newly defined IA32\_RTIT\_STATUS.Paused[8] MSR bit (Section 9.2.4) is set. If a TRACE\_RESUME trigger action is requested, then tracing resumes and the IA32\_RTIT\_STATUS.Paused[8] MSR bit is cleared. If both TRACE\_PAUSE and TRACE\_RESUME actions are requested, then no action will be taken by hardware and IA32\_RTIT\_STATUS.Paused[8] bit remains unchanged. The EN\_ICNT Trigger Action allows the trace decoder to determine the instruction pointer of the instruction that caused the trigger event. It is possible for multiple trigger events from the same trigger unit or from different trigger units to occur simultaneously. In this case, the resume or pause action is determined by the action of the youngest instruction that caused a trigger.

### 9.1.4 Programming Considerations

Software should follow these programming guidelines to enable the PTTT feature:

- Before configuring a trigger unit, software should ensure that the trigger action EN bit remains clear in the IA32\_RTIT\_TRIGGERx\_CFG MSR.
- Software should configure the corresponding performance monitor counter or debug register and set the corresponding IA32\_PERFEVTSELx\_MSR.EN\_PT\_LOG or DR7.DRx\_PT\_LOG bits before writing to the trigger input to set the EN bit.
- Software should only set the EN bit when all fields of the trigger input are populated (both trigger input and trigger action).
- Because unsupported encodings may not generate a fault, software should use extra care to use only supported encodings.

### 9.1.5 Trigger (TRIG) Packet

When a trigger event happens for an enabled trigger unit, a new PT packet called 'TRIG packet' will be generated if (IA32\_RTIT\_STATUS.TriggerEn=1 && IA32\_RTIT\_STATUS.FilterEn=1 && IA32\_RTIT\_STATUS.Paused=0). 'Paused' is the new status bit added in the IA32\_RTIT\_STATUS MSR defined in Section 9.2.4.

The format of the TRIG packet is defined in Table 9-4. The TRIG packet supplies information about which trigger(s) occurred in a cycle.

The ICNTV bit in a TRIG packet indicates whether the packet contains an ICNT field. If an ICNT trigger action is requested for that trigger unit, the TRIG packet will set ICNTV to 1 and include an ICNT field, which may be used to determine which instruction caused the trigger. The ICNT field indicates the number of instructions that have retired since the last IP indication, which was sent earlier (e.g., an earlier FUP, TIP, TIP.PGE, TNT, TRIG+ICNT packet). The ICNT field is a 16-bit unsigned value. It is possible for the ICNT instruction counter to overflow (i.e., when  $2^{16}$  instructions have retired since the last IP indication). In this overflow situation, the next trigger event will generate a TRIG packet with an ICNT of 0 and an IP of 1, and it will be followed by an FUP packet containing the instruction pointer of the instruction linked to the trigger. Like the overflow situation, when BranchEn=0, hardware will indicate a subsequent TRIG packet with an ICNT of 0 and an IP of 1, followed by an FUP packet containing the instruction pointer of the instruction linked to the trigger. When ContextEn=0, the TRIG packet will have ICNTV=0, indicating no valid ICNT information is available. If TNT was used as the last IP indication, the anchor IP is the destination IP of the last TNT bit, which is the branch destination if the branch was taken and the next IP if the branch was not taken. ICNT information will indicate the instruction that caused the trigger when the trigger is a PMC Event Increment for a precise event, a PMC Overflow for a PDIR counter counting a precise event, or a DRx Breakpoint Match. When the trigger is due to a non-precise PMC Event Increment or PMC Overflow, the ICNT information will indicate an instruction that retires soon after the event occurs. When the trigger is due to a PMC Overflow for a non-PDIR counter counting a precise event, the ICNT information will indicate an instruction that increments the event at or soon after the counter overflows (e.g., there may be some skid). This behavior corresponds to how PEBS attributes the instruction pointer for a PMC overflow event.

The TRBV field in a TRIG packet is a bitmap, indicating which trigger(s) fired. Each trigger unit has a corresponding bit in TRBV. For example, if the trigger event for trigger unit 3 triggered and caused a TRIG packet, then bit 3 of TRBV will be set in that TRIG packet. Multiple bits may be set in TRBV if multiple trigger units are fired in the same cycle. The MULT field in a TRIG packet allows the trace decoder to identify the instruction(s) to which the ICNT field applies. Table 9-3 describes the various scenarios and how software should interpret the ICNT field.

**Table 9-3. ICNT on Multiple Trigger Events**

TRBV (Bitmap)	MULT	ICNTV	Event Description
Don't Care	Don't Care	0	The ICNT field is not present in the TRIG packet because it is not enabled for any trigger event(s), or the trace is out of context. If ContextEn=0, the TRIG packet will have ICNTV = 0.
One Bit	0	1	A single trigger fired from a single instruction. The ICNT value refers to the instruction that caused the trigger event.
One Bit	1	1	A single trigger fired more than once from multiple instructions retired in the same cycle. The ICNT value refers to the first instruction that fired the trigger.
Multiple Bits	0	1	Multiple triggers were fired from the same instruction. The ICNT value refers to the instruction that caused the trigger events.
Multiple Bits	1	1	Multiple triggers were fired from multiple instructions retired on the same cycle. The ICNT value refers to the first instruction in the cycle fired from the trigger with the lowest numerical order.

TRIG packets are CYC-eligible. Also, if the TNT buffer is not empty when a TRIG packet is generated, a TNT packet will be generated before the TRIG packet. This allows the trace decoder to identify the instruction that caused the trigger(s) without waiting for a future TNT packet.

**Table 9-4. TRIG Packet Definition**

Name	Trigger (TRIG) Packet																																																								
Packet Format	<table border="1"> <tr> <td></td> <td>7</td> <td>6</td> <td>5</td> <td>4</td> <td>3</td> <td>2</td> <td>1</td> <td>0</td> </tr> <tr> <td>0</td> <td>1</td> <td>1</td> <td>0</td> <td>1</td> <td>1</td> <td>0</td> <td>0</td> <td>1</td> </tr> <tr> <td>1</td> <td>IP</td> <td>ICNTV</td> <td>MULT</td> <td colspan="5">Reserved</td> </tr> <tr> <td>2</td> <td colspan="8">TRBV</td> </tr> <tr> <td>3</td> <td colspan="8">ICNT[7:0]</td> </tr> <tr> <td>4</td> <td colspan="8">ICNT[15:8]</td> </tr> </table>				7	6	5	4	3	2	1	0	0	1	1	0	1	1	0	0	1	1	IP	ICNTV	MULT	Reserved					2	TRBV								3	ICNT[7:0]								4	ICNT[15:8]							
	7	6	5	4	3	2	1	0																																																	
0	1	1	0	1	1	0	0	1																																																	
1	IP	ICNTV	MULT	Reserved																																																					
2	TRBV																																																								
3	ICNT[7:0]																																																								
4	ICNT[15:8]																																																								
Dependencies	TriggerEn && FilterEn && ~Paused && Trigger-Cfg.Action.En && TriggerInputEnabled.  For PerfMon triggers, TriggerInputEnabled = PMC Enabled && PERFVTSEx.EN_PT_LOG For debug breakpoints triggers, TriggerInputEnabled = DRx Enabled && DR7.DRx_PT_LOG.	Generation Scenario	TRIG packet is generated when a trigger event happens.																																																						
Description	This packet indicates that one or more trigger(s) occurred in the same cycle. IP—Set to indicate if this trigger packet consumes the following FUP packet. ICNTV—Set indicates the ICNT field is present and valid. Set only when EN_ICNT trigger action is enabled. ICNT—Present only when ICNTV=1. Indicates the number of instructions retired since the last IP indication reference packets (FUP, TIP*, TNT, TRIG+ICNT). It is a 16-bit unsigned value. MULT—Indicates more than one instruction caused a trigger. When set, the ICNT value refers to the first instruction in the cycle that fired from the lowest-order trigger unit. TRBV—Trigger bit vector. Indicates all the trigger(s) that fired and are represented by this packet.																																																								
Application	TRIG packets indicate when a trigger event occurred. If the IP bit is set, a FUP will follow that is stand-alone, and the TRIG consumes the FUP. The FUP packet provides the precise IP of the trigger event, and ICNT will be zero in this case. If the IP bit is not set, TRIG is stand-alone, and ICNT indicates the number of retired instructions from the last anchor packet, which is a preceding TIP, TIP.PGE, FUP, TNT, or TRIG with ICNTV=1. In the case of TNT, the anchor IP is the destination IP of the last TNT bit, which is the branch destination if the branch was taken and the next IP if the branch was not taken. When ContextEn=0, ICNTV is cleared to 0. When BranchEn=0, ICNTV=1, IP=1, ICNT=0, pointing to the instruction that caused the trigger.																																																								

## 9.2 MSR CHANGES

New and current MSR changes are described in the subsections that follow. For an existing MSR, only changes to existing operation are highlighted in violet with change bars.

### 9.2.1 IA32\_RTIT\_TRIGGERx\_CFG

The IA32\_RTIT\_TRIGGERx\_CFG MSR allows the configuration of individual trigger units. Specifically, it allows the user to select the input for the trigger and the actions to be taken when the trigger event happens. The number of supported IA32\_RTIT\_TRIGGERx\_CFG MSRs is indicated in the CPUID.(EAX=14H,ECX=01H):EAX[10:8] field.

Table 9-5. IA32\_RTIT\_TRIGGERx\_CFG MSR Definition

Register Address: Hex, Decimal	Register Name (Former Register Name)	
Register Information / Bit Fields	Bit Description	Scope
Register Address: 568H–56EH, 1384–1390	IA32_RTIT_TRIGGERx_CFG	
Trace Trigger X Configuration Register (R/W)		Thread
6:0	Input0 (R/W) Selects the event used as a trigger input for trigger unit 0. The following encoding values are supported: <ul style="list-style-type: none"> <li>▪ 0H...7H: PMC[0...7] Event Increment.</li> <li>▪ 20H...27H: PMC[0...7] Overflow.</li> <li>▪ 40H...43H: DR[0...3] Breakpoint Match.</li> </ul> All other values are reserved. Reset value: 0.	
11:7	Reserved.	
15:12	Action0 (R/W) Bitmap field that selects the actions to be taken on a trigger event. The following bit encodings are supported: <ul style="list-style-type: none"> <li>▪ Bit 12: TRACE_RESUME—Trace Resume.</li> <li>▪ Bit 13: TRACE_PAUSE—Trace Pause.</li> <li>▪ Bit 14: EN_ICNT—Enable ICNT.</li> <li>▪ Bit 15: EN—Trigger Unit Enable.</li> </ul>	
22:16	Input1 (R/W) Same definition as Input0, but for trigger unit 1.	
27:23	Reserved.	
31:28	Action1 (R/W) Same definition as Action0, but for trigger unit 1.	
38:32	Input2 (R/W) Same definition as Input0, but for trigger unit 2.	
43:39	Reserved.	
47:44	Action2 (R/W) Same definition as Action0, but for trigger unit 2.	
54:48	Input3 (R/W) Same definition as Input0, but for trigger unit 3.	
59:55	Reserved.	
63:60	Action3 (R/W) Same definition as Action0, but for trigger unit 3.	

## 9.2.2 IA32\_PERFEVTSELx MSR Changes

The IA32\_PERFEVTSELx MSR is an existing MSR that describes a performance counter's configuration. When PTTT is supported, a new bit 38 is defined as EN\_PT\_LOG. If EN\_PT\_LOG is set to 1, that performance counter can be used as a trigger input in the IA32\_RTIT\_TRIGGERx\_CFG.Input fields.

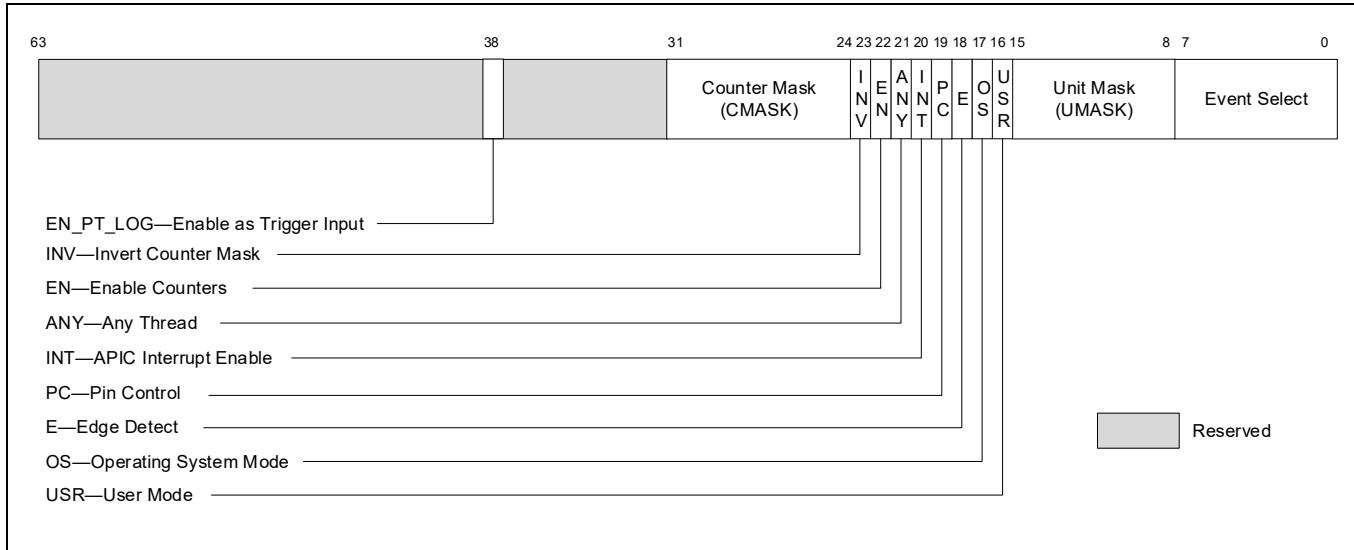

Figure 9-1. Layout of the IA32\_PERFVTSELx MSR

### 9.2.3 DR7 Changes

The DR7 Debug Control Register is an existing architectural register that can be used for enabling debug breakpoint matches. If an implementation supports DR Breakpoint Match as a PTTT trigger input, indicated by CPUID.(EAX=14H, ECX=01H):ECX[15]=1, then bits [35:32] of DR7 are described as DRx\_PT\_LOG bits, with the four bits corresponding to DR0-3. Note that the upper bits of DR7 are changed by MOV to DR7 only in 64-bit mode.

### 9.2.4 IA32\_RTIT\_STATUS Changes

A new 'Paused' bit is added to the IA32\_RTIT\_STATUS register as part of PTTT (see Table 9-6, bit 8). Hardware sets this bit when a PTTT paused trigger action occurs. Hardware clears this bit when a PTTT resume trigger action occurs. The Paused bit has read/write semantics. Software that wants tracing to start only after reaching a trigger can manually set Paused=1 before setting the TraceEn bit. When Paused=1, packets that depend on FilterEn=1 will be suppressed. PacketEn has the following updated semantics:

$$\text{PacketEn} := \text{BranchEn} \text{ AND } \text{TriggerEn} \text{ AND } \text{ContextEn} \text{ AND } \text{FilterEn} \text{ AND } \text{!Paused}$$

Note that, as defined in the Intel® 64 and IA-32 Architectures Software Developer’s Manual, Volume 3C, Section 33.2.6.3, Paused bit transitions that result in PacketEn transitions will also cause the hardware to generate PGE/PGD packets. Such PGE/PGD packets may have a small skid.

Table 9-6. IA32\_RTIT\_STATUS MSR Definition

Register Address: Hex, Decimal	Register Name (Former Register Name)	
Register Information / Bit Fields	Bit Description	Scope
Register Address: 571H, 1393	IA32_RTIT_STATUS	
Tracing Status Register (R/W)		Core
0	FilterEn Writes ignored.	
1	ContextEn Writes ignored.	
2	TriggerEn Writes ignored.	

Table 9-6. IA32\_RTIT\_STATUS MSR Definition (Contd.)

Register Address: Hex, Decimal	Register Name (Former Register Name)	
Register Information / Bit Fields	Bit Description	Scope
3	Reserved.	
4	Error	
5	Stopped	
6	PendPSB	
7	PendToPAPMI	
8	Paused	
31:9	Reserved, must be zero.	
48:32	PacketByteCnt	
63:49	Reserved, must be zero.	





This chapter documents the monitorless MWAIT feature.

Prior to this feature, execution of the MWAIT instruction causes a logical processor to suspend execution and enter an implementation-dependent optimized state only if the MONITOR instruction was executed previously, specifying an address range to monitor, and there have been no stores to that address range since MONITOR executed. The logical processor leaves the optimized state and resumes execution when there is a write to the monitored address range.

This existing functionality supports software that seeks to suspend execution until an event associated with a write to the monitored address range. For example, that range may contain the head pointer of a work queue that is written when there is work for the suspended logical processor.

It is possible that software may wish to suspend execution with no requirement to resume execution in response to a memory write. Such software is not well served by the existing MWAIT instruction since it must incur the overhead of monitoring some (irrelevant) address range and may resume execution earlier than intended following a memory write.

Monitorless MWAIT enhances the MWAIT instruction by allowing suspension of execution without monitoring an address range.

The feature is defined with an enumeration independent of that of existing MONITOR/MWAIT. That allows a VMM to virtualize monitorless MWAIT without having to virtualize the address-range monitoring of the existing feature.

## 10.1 USING MONITORLESS MWAIT

The MWAIT instruction uses the value of ECX to determine which MWAIT extensions are requested by software.

If ECX[2] is 1, an execution of MWAIT is **monitorless**. The logical processor will suspend execution and enter an implementation-dependent optimized state regardless of any previous execution of the MONITOR instruction. There is no address range to which a write is guaranteed to cause the logical processor to leave the optimized state and resume execution.

Software may set ECX[2] while also setting other bits in ECX that control other aspects of MWAIT execution.

Execution of MWAIT with ECX[2] = 1 is allowed only if the processor enumerates support for monitorless MWAIT (see Section 10.2); if it is not, such an execution causes a general-protection fault (#GP(0)).

See Section 10.5 for details on the operation of the MWAIT instruction.

## 10.2 ENUMERATION

Existing processors indicate support for the MONITOR and MWAIT instructions by enumerating CPUID.01H:ECX.MONITOR[bit 3] as 1. This enumeration also implies support for CPUID leaf 05H, the MONITOR/MWAIT leaf. CPUID leaf 05H enumerates details of the operation of the MONITOR instruction (e.g., the size of the monitored address range) and the capabilities of the MWAIT instruction (e.g., the extensions that can be specified in ECX).

CPUID.05H:ECX.MONITORLESS\_MWAIT[bit 3] enumerates support for monitorless use of MWAIT. If this bit is enumerated as 1, software can execute MWAIT with ECX[2] = 1 (see Section 10.1).

To allow virtualization of monitorless MWAIT (without the monitored form; see Section 10.4), CPUID.(EAX=07H, ECX=01H):EDX.MWAIT[bit 23] indicates support for the MWAIT instruction and for CPUID leaf 05H. The following items detail the implications of the value enumerated for this bit:

- If CPUID.(EAX=07H, ECX=01H):EDX.MWAIT[bit 23] is enumerated as 0, MWAIT is still supported if CPUID.01H:ECX.MONITOR[bit 3] is enumerated as 1. Monitorless MWAIT is supported only if CPUID.05H:ECX.MONITORLESS\_MWAIT[bit 3] is enumerated as 1.

- If CPUID.(EAX=07H, ECX=01H):EDX.MWAIT[bit 23] is enumerated as 1, MONITOR is supported as long as CPUID.01H:ECX.MONITOR[bit 3] is enumerated as 1. Monitorless MWAIT is supported only if CPUID.05H:ECX.MONITORLESS\_MWAIT[bit 3] is enumerated as 1.
- If CPUID.(EAX=07H, ECX=01H):EDX.MWAIT[bit 23] is enumerated as 1 and CPUID.01H:ECX.MONITOR[bit 3] is enumerated as 0, MWAIT is supported but MONITOR is not. Moreover, only the monitorless form of MWAIT is supported; execution of MWAIT with ECX[2] = 0 causes #GP(0).

Software seeking to use MONITOR and MWAIT together should continue to use CPUID.01H:ECX.MONITOR[bit 3] and CPUID leaf 05H. Software seeking to use monitorless MWAIT should consult CPUID.(EAX=07H, ECX=01H):EDX.MWAIT[bit 23] and CPUID leaf 05H.

### NOTE

Cores in hybrid CPU support MWAIT consistently. A core will support monitorless MWAIT only if all cores in the hybrid CPU do so.

## 10.3 ENABLING

The MONITOR and MWAIT instructions are available only when IA32\_MISC\_ENABLE.ENABLE\_MONITOR\_FSM[bit 18] = 1.

If IA32\_MISC\_ENABLE.ENABLE\_MONITOR\_FSM[bit 18] = 0, execution of MONITOR or MWAIT causes an invalid-opcode exception (#UD). In addition, CPUID.01H:ECX.MONITOR[bit 3] and CPUID.(EAX=07H, ECX=01H):EDX.MWAIT[bit 23] are each enumerated as 0, and CPUID leaf 05H is not supported.

## 10.4 VIRTUALIZATION

A virtual-machine monitor (VMM) may want to present the abstraction of a virtual machine that supports monitorless MWAIT but not the existing monitoring of address ranges.

Such a VMM can virtualize CPUID to enumerate CPUID.(EAX=07H, ECX=01H):EDX.MWAIT[bit 23] as 1, CPUID.01H:ECX.MONITOR[bit 3] as 0, and CPUID.05H:ECX.MONITORLESS\_MWAIT[bit 3] as 1. The VMM can intercept executions of MONITOR and deliver a #UD to the guest; it can intercept executions of MWAIT and either (1) deliver a #GP(0) to the guest if ECX[2] = 0; or (2) virtualize monitorless MWAIT if ECX[2] = 1.

## 10.5 MWAIT INSTRUCTION DETAILS

All changes to existing MWAIT operation are highlighted in violet with change bars.

## MWAIT—Monitor Wait

Opcode	Instruction	Op/En	64-Bit Mode	Compat/Leg Mode	Description
0F 01 C9	MWAIT	Z0	Valid	Valid	A hint that allows the processor to stop instruction execution and enter an implementation-dependent optimized state until occurrence of a class of events.

### Instruction Operand Encoding

Op/En	Operand 1	Operand 2	Operand 3	Operand 4
Z0	N/A	N/A	N/A	N/A

### Description

MWAIT instruction provides hints to allow the processor to enter an implementation-dependent optimized state. There are two principal targeted usages: address-range monitor and advanced power management.

CPUID.01H:ECX.MONITOR[bit 3] and CPUID.(EAX=07H, ECX=01H):EDX.MWAIT[bit 23] both indicate the availability of MWAIT in the processor; the instruction is supported if either is enumerated as 1. When set, MWAIT may be executed only at privilege level 0 (use at any other privilege level results in an invalid-opcode exception). CPUID.05H:ECX.MONITORLESS\_MWAIT[bit 3] indicates the availability of MWAIT that does not use a monitored address range (with ECX[2] set; “monitorless MWAIT”) but does not indicate availability of MONITOR or of non-monitorless MWAIT (MWAIT with ECX[2] cleared).

The operating system or system BIOS may disable this instruction by using the IA32\_MISC\_ENABLE MSR; disabling MWAIT clears the CPUID feature flag and causes execution to generate an invalid-opcode exception.

This instruction’s operation is the same in non-64-bit modes and 64-bit mode.

ECX specifies optional extensions for the MWAIT instruction. EAX may contain hints such as the preferred optimized state the processor should enter. The first processors to implement MWAIT supported only the zero value for EAX and ECX. Later processors allowed setting ECX[0] to enable masked interrupts as break events for MWAIT or setting ECX[2] to enable monitorless MWAIT (see below). Software can use the CPUID instruction to determine the extensions and hints supported by the processor.

### MWAIT for Address Range Monitoring

For address-range monitoring, the MWAIT instruction operates with the MONITOR instruction. The two instructions allow the definition of an address at which to wait (MONITOR) and a implementation-dependent-optimized operation to commence at the wait address (MWAIT). The execution of MWAIT is a hint to the processor that it can enter an implementation-dependent-optimized state while waiting for an event or a store operation to the address range armed by MONITOR.

The following cause the processor to exit the implementation-dependent-optimized state: a store to the address range armed by the MONITOR instruction, an NMI or SMI, a debug exception, a machine check exception, the BINIT# signal, the INIT# signal, and the RESET# signal. Other implementation-dependent events may also cause the processor to exit the implementation-dependent-optimized state.

In addition, an external interrupt causes the processor to exit the implementation-dependent-optimized state either (1) if the interrupt would be delivered to software (e.g., as it would be if HLT had been executed instead of MWAIT); or (2) if ECX[0] = 1. Software can execute MWAIT with ECX[0] = 1 only if CPUID.05H:ECX[bit 1] = 1. (Implementation-specific conditions may result in an interrupt causing the processor to exit the implementation-dependent-optimized state even if interrupts are masked and ECX[0] = 0.)

Following exit from the implementation-dependent-optimized state, control passes to the instruction following the MWAIT instruction. A pending interrupt that is not masked (including an NMI or an SMI) may be delivered before execution of that instruction. Unlike the HLT instruction, the MWAIT instruction does not support a restart at the MWAIT instruction following the handling of an SMI.

If the preceding MONITOR instruction did not successfully arm an address range or if the MONITOR instruction has not been executed prior to executing MWAIT, then the processor will not enter the implementation-dependent-optimized state. Execution will resume at the instruction following the MWAIT.

## MWAIT for Power Management

MWAIT accepts a hint and optional extension to the processor that it can enter a specified target C state while waiting for an event or a store operation to the address range armed by MONITOR. Support for MWAIT extensions for power management is indicated by CPUID.05H:ECX[bit 0] reporting 1.

EAX and ECX are used to communicate the additional information to the MWAIT instruction, such as the kind of optimized state the processor should enter. ECX specifies optional extensions for the MWAIT instruction. EAX may contain hints such as the preferred optimized state the processor should enter. Implementation-specific conditions may cause a processor to ignore the hint and enter a different optimized state. Future processor implementations may implement several optimized “waiting” states and will select among those states based on the hint argument. Table 10-1 describes the meaning of ECX and EAX registers for MWAIT extensions.

**Table 10-1. MWAIT Extension Register (ECX)**

Bits	Description
0	Treat interrupts as break events even if masked (e.g., even if EFLAGS.IF=0). May be set only if CPUID.05H:ECX[bit 1] = 1.
1	Reserved.
2	Allows MWAIT to enter and stay in an implementation-dependent-optimized state regardless of whether an address range armed by MONITOR exists or has been stored to. May be set only if CPUID.05H:ECX.MONITORLESS_MWAIT[bit 3] = 1. Must be set if CPUID.01H:ECX.MONITOR[bit 3] = 0.
31:3	Reserved.

**Table 10-2. MWAIT Hints Register (EAX)**

Bits	Description
3:0	Sub C-state within a C-state, indicated by bits [7:4]
7:4	Target C-state* Value of 0 means C1; 1 means C2, etc. Value of 01111B means C0.  Note: Target C states for MWAIT extensions are processor-specific C-states, not ACPI C-states
31:8	Reserved.

Note that if MWAIT is used to enter any of the C-states that are numerically higher than C1, a store to the address range armed by the MONITOR instruction will cause the processor to exit MWAIT only if the store was originated by other processor agents. A store from non-processor agent might not cause the processor to exit MWAIT in such cases.

If MWAIT is used with ECX[2] set, it will ignore any preceding MONITOR instruction and will ignore stores to any address range that may have been monitored. Support for this is enumerated by CPUID.05H:ECX.MONITORLESS\_MWAIT[bit 3].

For additional details of MWAIT extensions, see Chapter 15, “Power and Thermal Management,” of Intel® 64 and IA-32 Architectures Software Developer’s Manual, Volume 3B.

## Operation

(\* MWAIT takes the argument in EAX as a hint extension and is architected to take the argument in ECX as an instruction extension MWAIT EAX, ECX \*)

```
{
WHILE (“Monitor Hardware is in armed state”) {
    implementation_dependent_optimized_state(EAX, ECX);
}
Set the state of Monitor Hardware as triggered;
}
```

## Intel C/C++ Compiler Intrinsic Equivalent

MWAIT void \_mm\_mwait(unsigned extensions, unsigned hints)

### Example Using a Monitored Address

MONITOR/MWAIT instruction pair must be coded in the same loop because execution of the MWAIT instruction will trigger the monitor hardware. It is not a proper usage to execute MONITOR once and then execute MWAIT in a loop. Setting up MONITOR without executing MWAIT has no adverse effects.

Typically the MONITOR/MWAIT pair is used in a sequence, such as:

```
EAX = Logical Address(Trigger)
ECX = 0 (*Hints *)
EDX = 0 (* Hints *)
IF (!trigger_store_happened) {
    MONITOR EAX, ECX, EDX
    IF (!trigger_store_happened) {
        MWAIT EAX, ECX
    }
}
```

The above code sequence makes sure that a triggering store does not happen between the first check of the trigger and the execution of the monitor instruction. Without the second check that triggering store would go unnoticed. Typical usage of MONITOR and MWAIT would have the above code sequence within a loop.

### Numeric Exceptions

None.

### Protected Mode Exceptions

#GP(0) If ECX[31:3] ≠ 0 or ECX[1] = 1.  
 If ECX[0] = 1 and CPUID.05H:ECX[bit 1] = 0.  
 If ECX[2] = 1 and CPUID.05H:ECX.MONITORLESS\_MWAIT[bit 3] = 0.  
 If ECX[2] = 0 and CPUID.01H:ECX.MONITOR[bit 3] = 0.

#UD If CPUID.01H:ECX.MONITOR[bit 3] = 0 and  
 CPUID.(EAX=07H, ECX=01H):EDX.MWAIT[bit 23] = 0.  
 If current privilege level is not 0.

### Real Address Mode Exceptions

#GP If ECX[31:3] ≠ 0 or ECX[1] = 1.  
 If ECX[0] = 1 and CPUID.05H:ECX[bit 1] = 0.  
 If ECX[2] = 1 and CPUID.05H:ECX.MONITORLESS\_MWAIT[bit 3] = 0.  
 If ECX[2] = 0 and CPUID.01H:ECX.MONITOR[bit 3] = 0.

#UD If CPUID.01H:ECX.MONITOR[bit 3] = 0 and  
 CPUID.(EAX=07H, ECX=01H):EDX.MWAIT[bit 23] = 0.

### Virtual 8086 Mode Exceptions

#UD The MWAIT instruction is not recognized in virtual-8086 mode (even if  
 CPUID.01H:ECX.MONITOR[bit 3] = 1 or CPUID.(EAX=07H, ECX=01H):EDX.MWAIT[bit 23] = 1).

### Compatibility Mode Exceptions

Same exceptions as in protected mode.

## 64-Bit Mode Exceptions

#GP(0)	If RCX[63:3] $\neq$ 0 or RCX[1] = 1. If RCX[0] = 1 and CPUID.05H:ECX[bit 1] = 0. If RCX[2] = 1 and CPUID.05H:ECX.MONITORLESS_MWAIT[bit 3] = 0. If RCX[2] = 0 and CPUID.01H:ECX.MONITOR[bit 3] = 0.
#UD	If the current privilege level is not 0. If CPUID.01H:ECX.MONITOR[bit 3] = 0 and CPUID.(EAX=07H, ECX=01H):EDX.MWAIT[bit 23] = 0.

Processor Event-Based Sampling (PEBS) is a non-destructive profiling facility that enables capturing the CPU state, e.g., the Instruction Pointer register, memory access address, etc., when the counter of a Performance Monitoring (PerfMon) event, such as a cache miss or a retired instruction, overflows. Architectural PEBS creates a permanent, enumerated, and stable event-based sampling architecture based on the positive evolution of legacy PEBS.

A counter can select, independently from other counters, any of the following state groups to be included on its samples:

- Basic group (Instruction Pointer, time-stamp)
- Memory Auxiliary group
- General-Purpose Registers group
- XSAVE-Enabled Registers (XER) group
- Last Branch Records (LBRs) group
- Performance-monitoring Counters group

Additionally, the counter reload value dictates the sampling rate of PEBS. The counter can be configured for either a precise or non-precise event.

Architectural PEBS expands on the usability and applicability of legacy PEBS versions. The Output Buffer, a memory area where the processor dumps the CPU state, is physically addressed and configured via MSRs, making it virtualization-friendly for system-wide profiling (e.g., for hypervisors).

Architectural PEBS configuration is per counter in support of multi-tenant environments. The PEBS record is restructured, too, for a consistent yet expandable format for tools and enriched with additional state information (e.g., the XER group). Architectural PEBS ensures a state is not exposed across protection boundaries. It also improves the performance over previous PEBS versions using PMI-based sampling. Note that any cores using architectural PEBS will not support legacy PEBS, as it will have been deprecated.

The capabilities of PEBS are enumerated through the CPUID instruction.

The remaining sections of this chapter are organized as follows: Section 11.1 defines the enumeration of Architectural PEBS; Section 11.2 previews this feature's behavior; Section 11.3 defines the details of its registers; Section 11.4 defines the details of the PEBS records; and Section 11.5 defines its interactions with other Intel Architecture technologies.

## 11.1 ENUMERATION

If CPUID.(EAX=23H, ECX=0H):EAX[5] is set to 1, the processor supports Architectural PEBS. In this case, Subleaves 04H and 05H of CPUID Leaf 23H indicate details of Architectural PEBS capabilities. MSR enumeration of legacy PEBS is also modified, as described in Section 11.1.1 and Section 11.1.2.

The details of CPUID Leaf 23H are shown in Table 1-3 of Chapter 1.

### 11.1.1 IA32\_PERF\_CAPABILITIES

Architectural PEBS requires changes to the IA32\_PERF\_CAPABILITIES MSR (address 345H):

- BASELINE[14] = 0.
- PEBS\_TRAP[6], PEBS\_ARCH\_REG[7], and PEBS\_TIMING\_INFO[17] = 1.
- PEBS\_RECORD\_FORMAT[11:8] = 0xF (legacy PEBS is unavailable).
- PEBS\_Output\_PT\_Available[16] = 0.

### 11.1.2 IA32\_MISC\_ENABLE

Architectural PEBS requires changes to the IA32\_MISC\_ENABLE MSR (address 1A0H). Specifically, the read-only field PEBS\_UNAVAILABLE[12] is removed, but its value is kept as 1.

## 11.2 BEHAVIOR

The processor effectively stores the selected CPU state to memory when a PEBS event occurs, namely after a performance-monitoring counter overflows. The counter can be configured with a precise or non-precise performance-monitoring event. PEBS generates a record for precise events immediately after the instruction (as specified by the Instruction Pointer field of the Basic group) that experienced the event. For non-precise events, PEBS generates a record for some instruction when the counter overflows.

A PEBS record is always generated at an instruction boundary, reducing the need for expensive performance monitoring interrupt (PMI)-based sampling.

For historical information, see Chapter 21 of the Intel® 64 and IA-32 Architectures Software Developer's Manual, Volume 3B.

### 11.2.1 Counters

Section 21.2 of the Intel® 64 and IA-32 Architectures Software Developer's Manual, Volume 3B, describes general-purpose and fixed-function counters.

Also refer to Section 21.2.6, "Architectural Performance Monitoring Version 6," of the Intel® 64 and IA-32 Architectures Software Developer's Manual, Volume 3B, for more details on the performance monitoring architecture. Use CPUID to enumerate the number and type of counters.

Reload values associated with individual counters are set in the lowest 32 bits of the extension registers, specifically IA32\_PMC\_GPn\_CFG\_C.RELOAD\_VALUE[31:0] for general-purpose counters and IA32\_PMC\_FXm\_CFG\_C.RELOAD\_VALUE[31:0] for fixed-function counters, where n and m are the counter numbers.

Since the counters count up, the reload values are configured by storing the two's-complement negation first. For example, the value 1024 would be written as -1024 or 0xFFFFFC00 using 32 bits. On a reload, for a 48-bit Architectural performance-monitoring counter, the processor 1-extends this to 48 bits (0xFFFF\_FFFFC00).

Furthermore, PEBS is enabled for a counter when the logical processor's CPL (Current Privilege Level) satisfies the counter configuration.

Architectural PEBS / Architectural PerfMon does not mandate a particular sequence for enabling counting. However, our clear recommendation is to enable IA32\_PERF\_GLOBAL\_CTRL last / disable it first as it provides atomic starting/stopping of the counters.

To reiterate, the PEBS enable bits are distributed per counter, unlike the "global" register in model-specific PEBS.

### 11.2.2 Record Data

The CPU writes a PEBS Record for each counter that has overflowed at the instruction boundary. Each PEBS Record contains a header followed by a collection of record groups. The header contains information about the size of the PEBS record and a bit vector indicating the presence of selected record groups. Available record groups are the Basic group, the Memory Auxiliary group, the General-Purpose Registers group, the XSAVE-Enabled Registers group, the Last Branch Records group, and the Performance-Monitoring Counters group. The Basic group is present by default in PEBS records as it includes necessary data for processing a record. These groups are listed in Table 11-1 and described in detail in Section 11.4, "Records and Groups."



Table 11-1. Architectural PEBS Configuration Locations

Register/Format	Bit Description										
	31	30	29	28:24	23:21	20:19	18:16	15:10	9:8	7:3	2:0
CPUID.(EAX=23H, ECX=04H):EBX	0	AUX	GPR	0	XER	0	XER	0	LBR	CNTR/A	0
	63	62	61	60:56	55:53	52:51	50:49	48:42	41:40	39:35	34:32
IA32_PMC_GPn_CFG_C IA32_PMC_FXm_CFG_C	PEBS_EN	AUX	GPR	MBZ	XER	MBZ	XER	MBZ	LBR	CNTR/A	MBZ
	63	62	61	60:56	55:53	52:51	50:49	48:42	41:40	39:35	
PEBS Record Format	BASIC	AUX	GPR	RSVD	XER	RSVD	XER	RSVD	LBR	CNTR/ RSVD	RSVD

### 11.2.3 Programming PEBS

This section lists the programming guidelines<sup>1</sup> that system software should follow in the specified order. Then, it illustrates the behavior through an example.

#### 11.2.3.1 Programming Guidelines at Initialization Phase

1. Disable counting globally.
2. Setup the PEBS output buffer via the IA32\_PEBS\_BASE and IA32\_PEBS\_INDEX registers.
3. Configure counter(s).<sup>2</sup>
  - a. Configure a performance-monitoring event into a counter.<sup>3</sup>
    - i. Select a performance-monitoring event via the IA32\_PMC\_GPn\_CFG\_A MSR for general-purpose counters. This step does not apply for fixed-function counters.
    - ii. Set CPL filters via the IA32\_PMC\_GPn\_CFG\_A MSR for general-purpose counters or via the IA32\_FIXED\_CTR\_CTRL MSR for fixed-function counters.
    - iii. Enable the counter locally.
  - b. Configure PEBS for the same counter via the IA32\_PMC\_GPn/FXm\_CFG\_C MSR.<sup>4</sup>
    - i. Program a Reload value.
    - ii. Select the groups to be included in the PEBS records; see Table 11-1.
    - iii. Set the PEBS\_EN bit.
  - c. Initialize the counter register with its Reload value.
4. Re-enable counting globally.

- 
1. The first and last steps in both lists may rely on IA32\_PERF\_GLOBAL\_CTRL. Architectural PEBS and Architectural Performance-Monitoring do not mandate a particular sequence for enabling counting. However, the recommendation is to enable IA32\_PERF\_GLOBAL\_CTRL last or disable it first, as it provides atomic starting and stopping of the counters and ensures the least disruption to profiling.
  2. Step 3 in Section 11.2.3.1 may be repeated for each counter that software wishes to generate a PEBS record, at initialization, or when another event is configured (e.g., event-counter multiplexing usage).
  3. The counter registers are accessed in the IA32\_PMC\_GPn\_CTR MSR for general-purpose counter n, or in the IA32\_PMC\_FXm\_CTR MSR for fixed-function counter m.
  4. Details on the referenced IA32\_\* registers can be found in the Intel® 64 and IA-32 Architectures Software Developer's Manual, Volume 4.

### 11.2.3.2 Programming Guidelines at Runtime (e.g., Inside the PMI Interrupt Service Routine)

1. Disable counting globally.
2. Handle PEBS.
  - a. Drain data from the PEBS buffer; for example, copy-over data to another buffer. This is the most-common case for which PEBS-triggered PMI is invoked.
  - b. Update IA32\_PEBS\_INDEX[WR\_OFFSET] to the start of the PEBS buffer, if needed.
  - c. Clear IA32\_PERF\_GLOBAL\_STATUS[ARCH\_PEBS] via the IA32\_PERF\_GLOBAL\_STATUS\_RESET MSR if the PEBS buffer Threshold is enabled and/or Clear IA32\_PEBS\_INDEX[Full].
3. Handle counter n overflow.
  - a. Set the counter register to its Reload value. Retrieve n, the counter index, via one of the following methods:
    - i. The Applicable Counter field of the Basic group of most recent record(s) in step 2a above.
    - ii. Traversing the counter registers' values.
  - b. In some usages, software may need to save the current value of counter n, prior to reloading the counter value.
4. Re-enable counting globally.

For general-purpose counters, PEBS is enabled when IA32\_PMC\_GPn\_CFG\_C.PEBS\_EN && IA32\_PERF\_GLOBAL\_CTRL.EN[n] && IA32\_PMC\_GPn\_CFG\_A.CNTR\_EN is true, where n is the counter index.

For fixed-function counters, PEBS is enabled when IA32\_PMC\_FXm\_CFG\_C.PEBS\_EN && IA32\_PERF\_GLOBAL\_CTRL.EN[32+m] && IA32\_FIXED\_CTR\_CTRL.[USR|OS]m is true, where m is the counter index.

Furthermore, PEBS is enabled for a counter when the logical processor's Current Privilege Level (CPL) satisfies the counter configuration. The PEBS enable bits are distributed *per counter*, unlike the "global" register in legacy PEBS.

#### Example 11-1. Programming PEBS

To get the records, as shown in Figure 11-1, software should use the following steps:

1. Disable counting globally by writing zero to the IA32\_PERF\_GLOBAL\_CTRL MSR (address 38FH).
2. Set up IA32\_PEBS\_BASE and IA32\_PEBS\_INDEX registers.
3. For the general-purpose counter 1:
  - a. Configure the event BR\_INST\_RETIRED.ALL\_BRANCHES, which counts retired branches.
  - b. Set the PEBS\_EN[63] bit in the IA32\_PMC\_GP1\_CFG\_C MSR (address 1907H). This enables PEBS.
  - c. Put the 32-bit reload value into IA32\_PMC\_GP1\_CFG\_C.RELOAD\_VALUE.
  - d. There is no need to set other bits for the optional groups since the Basic group is included by default in PEBS records.
4. For the fixed-function counter 1:
  - a. Locally enable it by setting the CPL bits IA32\_FIXED\_CTR\_CTRL.[USR1|OS1]. This counter counts CPU\_CLK\_UNHALTED.THREAD – Unhalted Core Cycles.
  - b. Set the PEBS\_EN[63] bit in the IA32\_PMC\_FX1\_CFG\_C MSR (address 1987H). This enables PEBS.
  - c. Put the 32-bit reload value into IA32\_PMC\_FX1\_CFG\_C.RELOAD\_VALUE.
  - d. Set the AUX[62] bit and GPR[61] bit in the IA32\_PMC\_FX1\_CFG\_C MSR. This includes the AUX and GPR groups in the record.
5. Re-enable counting globally by setting bits 1 and 33 in the IA32\_PERF\_GLOBAL\_CTRL MSR to start counting on both counters. See Section 2.1, "Architectural MSRs," in the Intel® 64 and IA-32 Architectures Software Developer's Manual, Volume 4, for details of the MSR.

When the general-purpose counter and the fixed-function counter overflow, the two records are written to memory.

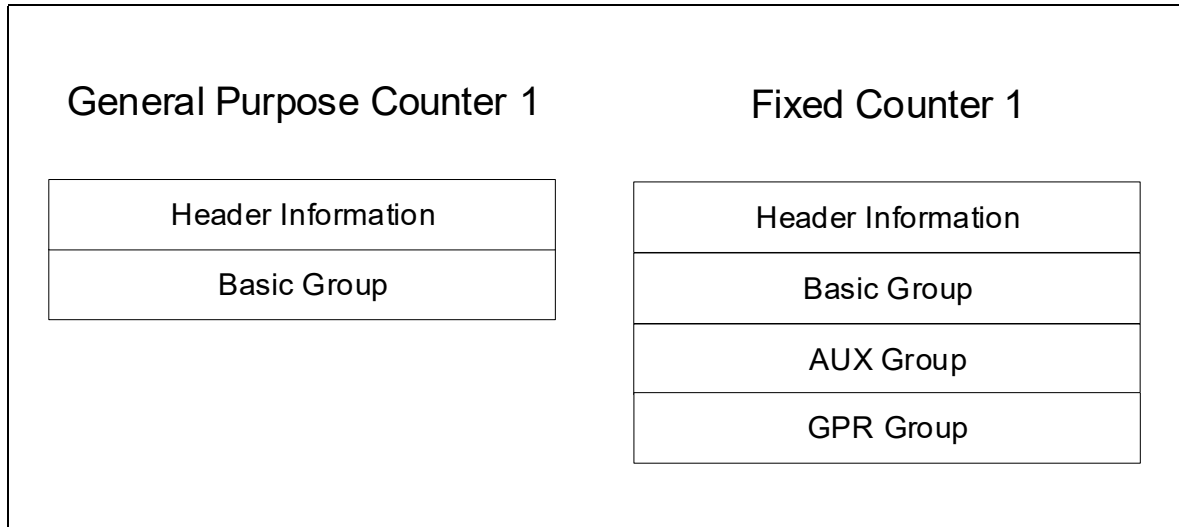

Figure 11-1. Example PEBS Record

### 11.3 MODEL-SPECIFIC REGISTERS (MSRS)

The Architectural PEBS MSRs are listed in Table 11-2.

Table 11-2. Architectural PEBS MSRs

Register Address: Hex, Decimal	Register Name	
Register Information / Bit Fields	Bit Description	Scope
Register Address: 3F4H, 1012	IA32_PEBS_BASE	
Arch PEBS Output Buffer Base Register (R/W) Holds the start address and size of the output buffer. This MSR exists only if CPUID.(EAX=23H,ECX=0H):EAX[5] == 1.		
Register Address: 3F5H, 1013	IA32_PEBS_INDEX	
Arch PEBS Output Buffer Base Register (R/W) This MSR exists only if CPUID.(EAX=23H,ECX=0H):EAX[5] == 1.		
Register Address: 1903H, 1907H, ..., 1903H+(4*n), 6403, 6407, ..., 6403 +(4*n)	IA32_PMC_GPn_CFG_C	
Extended Performance Event Selector for GP Counter x (R/W) For general-purpose counters, the IA32_PMC_GPn_CFG_C MSR is available if either CPUID.(EAX=23H,ECX=05H):EAX[n] or CPUID.(EAX=23H,ECX=02H):EAX[n] is set. Reserved bits must be zero.		
Register Address: 1983H, 1987H, ..., 1983H+(4*m), 6531, 6535, ..., 6531 +(4*m)	IA32_PMC_FXm_CFG_C	
Extended Performance Event Selector for Fixed-Function Counter x (R/W) For fixed-function counters, the IA32_PMC_FXm_CFG_C MSR is available if either CPUID.(EAX=23H,ECX=05H):ECX[m] or CPUID.(EAX=23H, ECX=02H):EBX[m] is set. Reserved bits must be zero.		

### 11.3.1 IA32\_PEBS\_BASE MSR

Table 11-3 shows the layout of the IA32\_PEBS\_BASE MSR, the Output Buffer Base Register MSR. The functions of the flags and fields are:

- **SIZE field** (bits 3:0) – Specifies the output buffer size in powers of 2, where buffer size = 4 KB \* 2<sup>SIZE</sup>, e.g., SIZE = 7 results in a 512 KB output buffer and SIZE = 9 results in a 2 MB output buffer. The maximum SIZE value is 15, or 128 MB output buffer.
- Reserved field (bits 11:4) – Reserved for future usage and must be zero.
- **PHYS\_ADDR** (bits (MAXPHYADDR – 1):12) – Specifies the value of the base physical address of a single, contiguous physical output region.
- Reserved field (bits 63:MAXPHYADDR) – Reserved for future usage and must be zero.

The MSR is initialized to all zeros on reset.

**Table 11-3. IA32\_PEBS\_BASE MSR**

Register Address: Hex, Decimal	Register Name	
Register Information / Bit Fields	Bit Description	Scope
Register Address: 3F4H, 1012	IA32_PEBS_BASE	
Architectural PEBS Output Buffer Base Register (R/W) Holds basic structural controls for Architectural PEBS. This MSR exists only if CPUID.(EAX=23H, ECX=0H):EAX[5] == 1.		
3:0	SIZE (R/W) Size options for the PEBS output buffer (actual size is power-of-2 multiples of 4KB, that is, Buffer Size = 4KB * 2 <sup>SIZE</sup> ).	
11:4	Reserved.	
MAXPHYADDR - 1:12	PHYS_ADDR (R/W) Start of the PEBS output buffer (4KB-aligned physical address, excluding the 12b page offset).	
63:MAXPHYADDR	Reserved.	

### 11.3.2 IA32\_PEBS\_INDEX MSR

Table 11-4 shows the layout of the IA32\_PEBS\_INDEX MSR, the Output Buffer Index Register MSR. The functions of the flags and fields are:

- Reserved field (bits 3:0) – Reserved for future usage and must be zero.
- **WR\_OFFSET** field (bits 26:4) – Specifies the value of the next-byte-to-write offset from IA32\_PEBS\_BASE.PHYS\_ADDR.
- Reserved field (bits 30:27) – Reserved for future usage and must be zero.
- **FULL** flag (bit 31) – When set, the output buffer is full, and no further records will be generated.
- **THRESH\_EN** field (bit 32) – When set, the PMI threshold is enabled.
- Reserved field (bits 35:33) – Reserved for future usage and must be zero.
- **THRESH\_OFFSET** field (bits 58:36) – Specifies the value of bits [26:4] of the PMI threshold offset from the output buffer base.
- Reserved field (bits 63:59) – Reserved for future usage and must be zero.

The MSR is initialized to all zeros on reset.

Table 11-4. IA32\_PEBS\_INDEX MSR

Register Address: Hex, Decimal	Register Name	
Register Information / Bit Fields	Bit Description	Scope
Register Address: 3F5H, 1013	IA32_PEBS_INDEX	
Arch PEBS Output Buffer Index Register (R/W) Holds status and additional controls for Architectural PEBS. This MSR exists only if CPUID.(EAX=23H, ECX=0H):EAX[5] == 1.		
3:0	Reserved.	
26:4	WR_OFFSET (R/W) Next-byte-to-write offset from IA32_PEBS_BASE.PHYS_ADDR.	
30:27	Reserved.	
31	FULL (R/W) The buffer is full, and no further records will be generated.	
32	THRESH_EN (R/W) Enable PMI on PEBS buffer Threshold checks.	
35:33	Reserved.	
58:36	THRESH_OFFSET (R/W) The threshold for the PEBS buffer (specified as offset in bytes from IA32_PEBS_BASE.PHYS_ADDR).	
63:59	Reserved.	

### 11.3.3 IA32\_PMC\_GPn\_CFG\_C and IA32\_PMC\_FXm\_CFG\_C MSRs

Table 11-5 shows the layout of the Performance Event Select Extended Register MSRs. The IA32\_PMC\_GPn\_CFG\_C MSR is the Event Select Extended register for a general-purpose counter, while the IA32\_PMC\_FXm\_CFG\_C MSR is the Event Select Extended register for a fixed-function counter, where n and m are the counter numbers. The functions of the flags and fields are:

- RELOAD\_VALUE field (bits 31:0) – Selects a 32-bit value loaded into IA32\_PMC\_GPn\_CTR when a PEBS record is generated due to counter n. For a 48-bit counter, the value will be 1-extended into a 48-bit value.
- Reserved field (bits 34:32) – Reserved for future usage and must be zero.
- ALLOW\_IN\_RECORD field (bit 35) – When set, indicates that this counter's value will be included in the PEBS record if the associated CNTR subgroup is enabled.
- CNTR field (bits 38:36) – When any bit is set, the counter group will be included in the PEBS record. If bit 36 is set, the general-purpose counters subgroup will be included. If bit 37 is set, the fixed-function counters subgroup will be included. If bit 38 is set, the performance metrics subgroup will be included and reset.
- Reserved field (bit 39) – Reserved for future usage and must be zero.
- LBR field (bits 41:40) – Identifies the number of Last Branch Records (LBRs) to record. The encodings of this field are as follows:
  - 00 – LBR group will not be recorded. The group is disabled.
  - 01 – 8 LBRs will be recorded.
  - 10 – 16 LBRs will be recorded.
  - 11 – The number of LBRs to be recorded is IA32\_LBR\_DEPTH.DEPTH.
- Reserved field (bits 48:42) – Reserved for future usage and must be zero.
- XER field (bits 55:49) – When set, enables particular XSAVE-Enabled Registers to be included in the PEBS record. The encodings for the register subgroup are:

- Bit 49 – SSER: Record XMM0-XMM15.
- Bit 50 – YMMHIR: Record the upper 128 bits of YMM0-YMM15.
- Bit 53 – OPMASKR: Record K0-K7.
- Bit 54 – ZMMHIR: Record the upper 256 bits of ZMM0-ZMM15.
- Bit 55 – Hi16ZMMR: Record ZMM16-ZMM31.
- Reserved field (bits 60:56) – Reserved for future usage and must be zero.
- GPR field (bit 61) – When set, this field enables the General-Purpose Registers group to be included in the PEBS record.
- AUX field (bit 62) – When set, this field enables the Auxiliary group to be included in the PEBS record.
- PEBS\_EN field (bit 63) – When set, PEBS is enabled for this counter.

On reset, the MSR is initialized to all zeros.

**Table 11-5. IA32\_PMC\_GPn\_CFG\_C and IA32\_PMC\_FXm\_CFG\_C MSRs**

Register Address: Hex, Decimal	Register Name	
Register Information / Bit Fields	Bit Description	Scope
Register Address: 1903H, 1907H, ..., 1903H+(4*n), 6403, 6407, ..., 6403 +(4*n)	IA32_PMC_GPn_CFG_C	
Extended Performance Event Selector for GP Counter x (R/W) For general-purpose counters, the IA32_PMC_GPn_CFG_C MSR is available if either CPUID.(EAX=23H,ECX=05H):EAX[n] or CPUID.(EAX=23H,ECX=02H):EAX[n] is set. Reserved bits must be zero.		
31:0	RELOAD_VALUE (R/W) Contains the reload value to be loaded into the associated counter by Auto Counter Reload. It will be 1-extended to 48 bits.	
34:32	Reserved.	
35	ALLOW_IN_RECORD (R/W) If 1, indicates that this counter's value will be included in the PEBS record if the associated CNTR subgroup is enabled.	
38:36	CNTR (R/W) When any bit is set, the counter group will be included in the PEBS record. Bit 36: If 1, the general-purpose counters subgroup will be included. Bit 37: If 1, the fixed-function counters subgroup will be included. Bit 38: If 1, the performance metrics subgroup will be included and will be reset	
39	Reserved.	
41:40	LBR (R/W) Identifies the number of Last Branch Records (LBRs) to record. The encodings of this field are as follows: <ul style="list-style-type: none"> <li>▪ 00 – LBR group will not be recorded. The group is disabled.</li> <li>▪ 01 – 8 LBRs will be recorded.</li> <li>▪ 10 – 16 LBRs will be recorded.</li> <li>▪ 11 – The number of LBRs to be recorded is IA32_LBR_DEPTH.DEPTH.</li> </ul>	
48:42	Reserved.	

**Table 11-5. IA32\_PMC\_GPn\_CFG\_C and IA32\_PMC\_FXm\_CFG\_C MSRs (Contd.)**

Register Address: Hex, Decimal	Register Name	
Register Information / Bit Fields	Bit Description	Scope
55:49	XER (R/W) When set, enables particular XSAVE-Enabled Registers to be included in the PEBS record. The encodings for the register subgroup are: <ul style="list-style-type: none"> <li>▪ Bit 49 - SSER: Record XMM0-XMM15.</li> <li>▪ Bit 50 - YMMHIR: Record the upper 128 bits of YMM0-YMM15.</li> <li>▪ Bits 52:51 - Reserved and must be zero.</li> <li>▪ Bit 53 - OPMASKR: Record K0-K7.</li> <li>▪ Bit 54 - ZMMHIR: Record the upper 256 bits of ZMM0-ZMM15.</li> <li>▪ Bit 55 - Hi16ZMMR: Record ZMM16-ZMM31.</li> </ul>	
60:56	Reserved.	
61	GPR (R/W) If 1, enables the General-Purpose Registers Group to be included in the PEBS record.	
62	AUX (R/W) If 1, enables the Auxiliary Group to be included in the PEBS record.	
63	PEBS (R/W) If 1, PEBS is enabled for this counter.	
Register Address: 1983H, 1987H, ..., 1983H+(4*m), 6531, 6535, ..., 6531 +(4*m)	IA32_PMC_FXm_CFG_C	
Extended Performance Event Selector for Fixed-Function Counter x (R/W) For fixed-function counters, the IA32_PMC_FXm_CFG_C MSR is available if either CPUID.(EAX=23H,ECX=05H):ECX[m] or CPUID.(EAX=23H,ECX=02H):EBX[m] is set. Reserved bits must be zero.		
63:0	This MSR has identical bit definitions to the IA32_PMC_GPn_CFG_C MSR.	

### 11.3.4 Changes from Legacy PEBS

The following MSRs are removed and generate a #GP exception on any attempt to read or write them:

- IA32\_PEBS\_ENABLE
- MSR\_PEBS\_DATA\_CFG

Architectural PEBS does not use the IA32\_DS\_AREA MSR, but it is maintained for BTS use.

Bits 32, 36, 40, and 44 of IA32\_PMC\_FXm\_CFG\_C.ADAPTIVE\_RECORD\_CTRm will report 0 on a RDMSR and will generate a #GP exception on an attempt to set them. The same results occur with IA32\_PMC\_GPn\_CFG.Adaptive PEBS for all general-purpose counters.

See Section 20.9.2.1, "Adaptive\_Record Counter Control," of the Intel® 64 and IA-32 Architectures Software Developer's Manual, Volume 3B, for more information.

The IA32\_PERF\_GLOBAL\_STATUS, IA32\_PERF\_GLOBAL\_STATUS\_RESET, and IA32\_PERF\_GLOBAL\_STATUS\_SET MSRs are modified by adding a bit, ARCH\_PEBS[54]:

- The processor clears IA32\_PERF\_GLOBAL\_STATUS[54]=0 on a software write of 1 to IA32\_PERF\_GLOBAL\_STATUS\_RESET[54].
- The processor sets IA32\_PERF\_GLOBAL\_STATUS[54]=1 on a software write of 1 to IA32\_PERF\_GLOBAL\_STATUS\_SET[54].

See Section 20.2.4.2, "IA32\_PERF\_GLOBAL\_STATUS\_RESET and IA32\_PERF\_GLOBAL\_STATUS\_SET MSRs," of the Intel® 64 and IA-32 Architectures Software Developer's Manual, Volume 3B, for more information.

## 11.4 RECORDS AND GROUPS

All records begin with a 16-byte header, shown in Figure 11-2, which includes the 8-byte PEBS record format. The record format contains the following:

- The bit vector indicating the groups in the record.
- The record size, which may include end padding; see Section 11.4.7, “Fragmented Records.”
- Other indicator bits.

The remaining 8 bytes in the header are reserved.

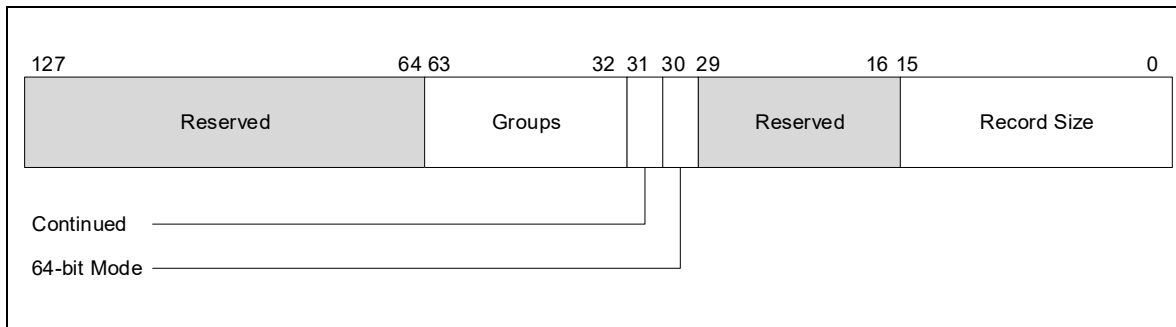

Figure 11-2. PEBS Record Format

The record size is a 16-bit field containing the size of the generated record (the header plus the groups) in bytes, with a maximum size of 64 kilobytes. A record always starts at a 16-byte aligned address. The size may include padding at the end for alignment reasons. The padding bytes would be stale and not written by the processor.

The Continued bit indicates that the record has additional groups in subsequent record fragments. Refer to Section 11.4.7, “Fragmented Records,” for an example.

A record continues in the architecturally defined group order: Basic group, Memory Auxiliary group, General-Purpose Registers group, XSAVE-Enabled Registers group, Last Branch Records group, and finally, Performance-Monitoring Counters group. The record is also compacted to place only those groups indicated in the bit vector contiguously.

All groups are aligned along 16-byte boundaries and multiples of 16 bytes. Some groups have reserved fields and subfields to preserve alignment requirements. Most groups have a predetermined size, though some are variable.

A processor may dump groups/fields in any temporal order, not necessarily per their offset.

### 11.4.1 Basic Group

The Basic group is present in all complete PEBS records.<sup>1</sup> The group size is 48 bytes and consists of the Instruction Pointer, Applicable Counter, Time-Stamp Counter, and Retire Latency fields. The final two fields in the group, each consisting of 8 bytes, are reserved for future growth.

Table 11-6 lists the Basic group's fields and the offset from the start of the Basic group. Each field is 64 bits wide.

Table 11-6. Basic Group Fields

Field Name	Byte Offset
Instruction Pointer	00H
Applicable Counter	08H
Time-Stamp Counter	10H
Retire Latency	18H

1. See Section 11.4.7, “Fragmented Records.”



**Table 11-6. Basic Group Fields (Contd.)**

Field Name	Byte Offset
Reserved	20H
Reserved	28H

### 11.4.1.1 Instruction Pointer

The Instruction Pointer field holds the RIP register value<sup>1</sup> of the instruction that retired immediately before emitting the PEBS record. This field is sometimes historically referred to as “EventingIP.”

For precise events, this is the instruction that triggered PEBS record generation. For non-precise events, this is some instruction when the counter overflows without necessarily stopping at the causing instruction.

If a record was generated immediately after execution just became “in context” for a given counter, then the Instruction Pointer of that record is considered “out of context.” A -1 value denotes an out-of-context Instruction Pointer. This behavior avoids leaking information across contexts.

Note that the Instruction Pointer field differs from the RIP field in the General-Purpose Registers group, which records the instruction pointer of the next instruction to be executed after record generation. Also, when not in 64-bit mode, the upper 32 bits will be zero.

### 11.4.1.2 Applicable Counter

This field indicates which counter(s) triggered the generation of the PEBS record.

Figure 11-3 shows the mapping of the various one-hot counter bits in the PEBS record. GP[n-1:0] is the bit vector of General-Purpose Counters, where GP0 starts at bit 0, and n is the maximum general-purpose counter ID supported. Fixed[32+m-1:32] is the bit vector of fixed-function counters, where FIXED0 starts at bit 32, and m is the maximum fixed-function counter ID supported. Bits that do not correspond to counters identified in Section 21.2.9, “Scalable Enumeration Architecture,” of the Intel® 64 and IA-32 Architectures Software Developer’s Manual, Volume 3B, are reserved.

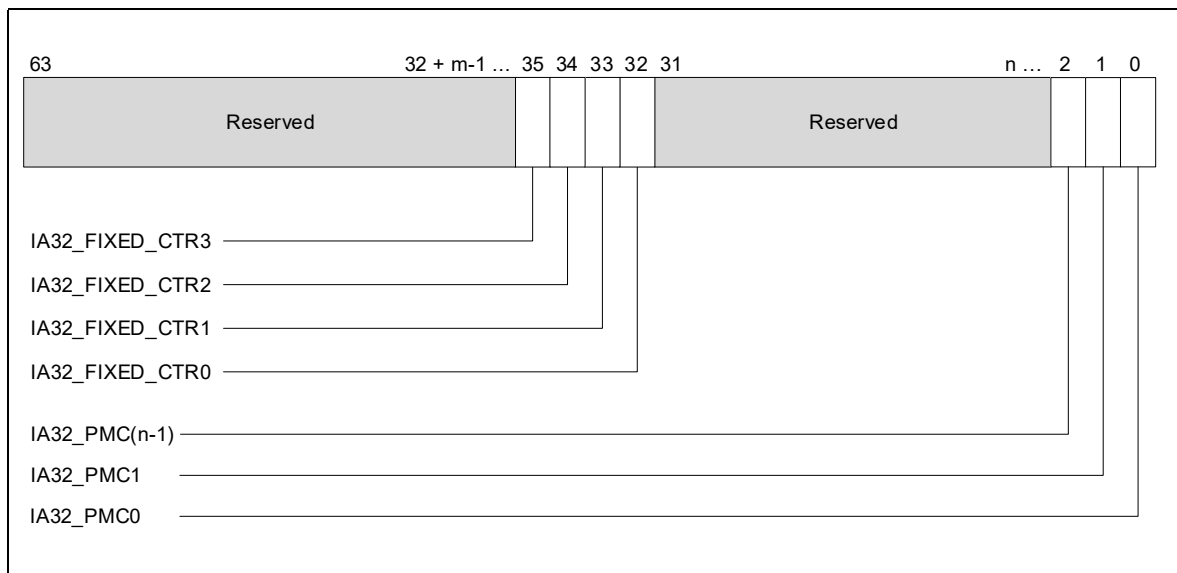

**Figure 11-3. Bit Mapping of Applicable Counters in the PEBS Record**

1. RIP register without the CS register base.

### 11.4.1.3 Time-Stamp Counter

The time-stamp counter is a 64-bit counter set to 0 following a processor reset. After a reset, the counter increments even when the HLT instruction or the external STPCLK# pin halts the processor.

The time-stamp counter will reflect the value of the counter when the record is generated, and it will include the offset and scale adjustments even if RDTSC Exiting is enabled (i.e., no exit taken). It is the same as Intel Processor Trace.

For more details, see Section 18.17, “Time-Stamp Counter,” of the Intel® 64 and IA-32 Architectures Software Developer’s Manual, Volume 3B.

### 11.4.1.4 Retire Latency

The Retire Latency field in the record will consist of:

- **Retire Latency field**, bits 15:0 – Indicates the elapsed cycles between the retirement of the architecturally-visible instruction that caused PEBS and the prior instruction retirement. The measurement reflects core unhalted cycles (at the pace of Fixed-Function Counter 1) and is reported for any PEBS, regardless of whether precise or non-precise events are programmed. The count saturates at 216-1.
- **Retire Latency Valid flag**, bit 16 – A valid bit for the Retire Latency field. When set, the Retire Latency field holds a valid value.
- Reserved field, bits 63:17 – Reserved for future usage.

## 11.4.2 Auxiliary Group

The Auxiliary (AUX) group is home to custom fields, often without ties to the state of a particular processor architectural feature and without architectural registers. The AUX group size is 64 bytes, consisting of 8 fields of 8 bytes each. The first 8-byte field is the Memory Access Address, followed by seven 8-byte reserved fields, as shown in Table 11-7. A named reserved field may have processor-dependent implementation.

**Table 11-7. Auxiliary Group Fields**

Field Name	Byte Offset
Memory Access Address	00H
Reserved	08H
Reserved	10H
Reserved	18H
Reserved	20H
Reserved (Memory Auxiliary Information)	28H
Reserved (Memory Access Latency)	30H
Reserved (TSX Auxiliary Information)	38H

If CPUID.(EAX=23H, ECX=04H):EBX.AUX[30] = 1, then the Auxiliary group is available. If AUX[62] in the counter’s Event Select Extended register is set, then the Auxiliary group will be included when that particular counter generates a PEBS record.

If PEBS Record Format.AUX[62] = 1 in the record itself, then the Auxiliary group is included.

All fields are populated in a model- and event-specific manner. None of the architectural events are architecturally specified to populate these fields, including the Memory Access Address field.

If the Memory Access Address population is not indicated in the model-specific event list, the field contents are reserved.

### 11.4.2.1 Memory Access Address

The Memory Access Address (MAA) is the 64-bit canonical linear address<sup>1</sup> of memory accessed by a load or store access of an instruction. The location of the MAA field is architectural, but which events update it and the address saved is model-specific. Unlike legacy PEBS, Architectural PEBS enables one instruction to generate multiple records with different MAA fields. For example, MOVDIR\* instructions have distinct load and store addresses.

The MAA will be the address of a linear access performed by the instruction immediately preceding the PEBS event (at EventingIP, or macrofused<sup>2</sup> to it), or zero. The MAA will never expose access from any of these cases:

- A filtered out CPL, even for ring transitions.
- Before any counters are enabled, e.g., a VMM address after a VM entry enables counters.
- Inside a production/opt-out enclave. (No PEBS records are taken during a production enclave, and PEBS records taken after EEXIT/AEX will have MAA=0).

For instructions with multiple linear load accesses, or multiple linear store accesses, which one (if any) is recorded is model-specific. Consult the online event list for more details on the MAA behavior for a particular processor: <https://perfmom-events.intel.com/>.

#### NOTE

For MSR flows (VMX MSR list, WRMSRLIST) that can disable and re-enable counters, it is possible for an MAA recorded before the disable to persist. Intel advises against such uses.

### 11.4.3 General-Purpose Register Group

The General-Purpose Register group contains 20 fields, each being 64 bits wide, for a total of 160 bytes. The group contains RFLAGS, RIP, RAX, RCX, etc., as well as the Shadow Stack Pointer (SSP), as shown in Table 5. The SSP will be zero on implementations that do not support CET or when CET is not in use.

If CPUID.(EAX=23H, ECX=04H):EBX.GPR[29] = 1, then the General-Purpose Register group is available. If IA32\_PMC\_GPn\_CFG\_C.GPR[61]=1 or IA32\_PMC\_FXm\_CFG\_C.GPR[61] = 1, then the record will include the General-Purpose Register group when the counter generates a PEBS record. In the PEBS record, if PEBS Record Format.GPR[61] = 1, the General-Purpose Register group is included.

**Table 11-8. General-Purpose Register Group Fields**

Field Name	Byte Offset
RFLAGS	00H
RIP	08H
RAX	10H
RCX	18H
RDX	20H
RBX	28H
RSP	30H
RBP	38H
RSI	40H
RDI	48H
R8	50H
...	...
R15	88H

1. No Linear Address Masking (LAM) bits are included.
2. Macrofusion merges two instructions to a single micro-op. See Section 3.4.2.2, "Optimizing for Macrofusion," in the Intel® 64 and IA-32 Architectures Optimization Reference Manual: Volume 1.

**Table 11-8. General-Purpose Register Group Fields (Contd.)**

Field Name	Byte Offset
SSP	90H
Reserved	98H

The fields are sized to support 64-bit mode. Non-64-bit modes include 32-bit mode, 16-bit mode, real mode, VM86 mode, and compatibility mode. Modes are checked at the time of PEBS record generation.

When not in 64-bit mode, the upper 32 bits of the RAX through RDI fields will be unmodified. Furthermore, fields for registers that “do not exist” are left unmodified, similar to how XSAVE handles vector registers. Space is not compacted away. Registers R8-R15 will be unmodified. This is consistent with model-specific PEBS behavior.

When not in 64-bit mode, fields for registers that do not exist are left unmodified. Core legacy model-specific PEBS wrote zero.

PEBS enable is not impacted by transitions into/out of long-mode. Some legacy PEBS versions used to disable it. The indicator bit in PEBS Record Format.64BIT\_MODE[30] will be set to 1 for 64-bit mode and 0 for other modes.

### 11.4.4 XSAVE-Enabled Registers Group

The XSAVE-Enabled Registers (XER) group is a super-group for user-level state with XSAVE architectural support, i.e., those supported by the XSAVE instruction. Five groups (or sub-groups) are available initially; see Table 11-9. Additional groups are likely to be supported in future generations. The supported groups depend on the ISA support of the processor. for SSER, YMMHIR, OPMASKR, ZMMHIR, and Hi16ZMMR as shown in Table 11-9. The supported sub-groups depend on the ISA support of the processor.

The bits CPUID.(EAX=23H, ECX=04H):EBX.XER[23:17] indicate which components of the XER super-group are available. The bits IA32\_PMC\_GPN\_CFG\_C.XER[55:49] and IA32\_PMC\_FXM\_CFG\_C.XER[55:49] select which groups of XER to include when the counter generates a PEBS record. The select bit in the \*CFG\_C MSRs is writeable if that group is available in CPUID.

The bits PEBS Record Format.XER[55:49] indicate which components of the XER group are included in the PEBS record. **This field is set to 0 if CR0.TS = 1 or CR4.OSXSAVE = 0. Otherwise, a bit is set only if a group is selected in the CFG MSR and the XCR0 bit corresponding to the group is set.** Group sizes are listed in Table 11-9.

**Table 11-9. XSAVE-Enabled Registers (XER) Group Fields and Sizes**

Field Name	Registers Used	Size
XSTATE_BV	XINUSE for groups included in PEBS Record Format.XER[55:49]	8 B
Reserved	Reserved	8 B
SSER	XMM0-XMM15	16 regs * 16 B = 256 B
YMMHIR	Upper 128 bits of YMM0-YMM15	16 regs * 16 B = 256 B
OPMASKR	K0-K7	8 regs * 8 B = 64 B
ZMMHIR	Upper 256 bits of ZMM0-ZMM15	16 regs * 32 B = 512 B
Hi16ZMMR	ZMM16-ZMM31	16 regs * 64 B = 1024 B

The first eight bytes include the XSAVES instruction’s XSTATE\_BV bit vector (reflecting INIT optimization). **This field is in XCR0 format.**

Memory space in the output buffer is allocated for the groups that are included in PEBS Record Format.XER[55:49]. The memory space is allocated but not written if that group is either not in use (that is, in the INIT state) or is disabled by XFD (eXtended Feature Disable). **(In this case the corresponding bit in XSTATE\_BV bitmap is set to 0.)** The memory space is allocated and written when all conditions are met (that is, the group is selected, enabled by XSAVE, and is in use).

Outside 64-bit mode, vector registers beyond XMM7/YMM7/ZMM7 are not accessible. Thus, the memory space is allocated but not written for those registers.

Processors that do not support a particular group, e.g., ZMMHIR, will have the corresponding bit clear in CPUID, and attempting to set the select bit will cause a #GP fault.

## 11.4.5 Last Branch Record Group

Last Branch Records (LBRs) enable the recording of the software path history by logging taken branches and other control flow transfers within processor registers. See Section 18.5, “Last Branch, Interrupt, and Exception Recording (Intel® Core™ 2 Duo and Intel Atom® Processors),” of the Intel® 64 and IA-32 Architectures Software Developer’s Manual, Volume 3B, for information about last branch records.

Table 11-10 lists the LBR fields.

Architectural PEBS can include a subset of the architectural LBRs available. Software may, independent to PEBS, reduce the number of active LBR records from the maximum using the IA32\_LBR\_DEPTH MSR.

The bits IA32\_PMC\_GPn\_CFG\_C.LBR[41:40] and IA32\_PMC\_FXm\_CFG\_C.LBR[41:40] indicate the number of LBR records to include in the Last Branch Record group. The encodings of this field are as follows:

- 00 – LBR group will not be recorded. The group is disabled.
- 01 – 8 LBRs will be recorded.
- 10 – 16 LBRs will be recorded.
- 11 – Variable size: the number of LBRs to be recorded is defined by IA32\_LBR\_DEPTH.DEPTH.

The bits PEBS Record Format.LBR[41:40] indicate the number of LBR records in the group.

**Table 11-10. Last Branch Record Group Fields**

Field Name	Byte Offset
Reserved	00H
IA32_LBR_CTL	08H
IA32_LBR_DEPTH	10H
IA32_LER_FROM_IP	18H
IA32_LER_TO_IP	20H
IA32_LER_INFO	28H
IA32_LBR_0_FROM_IP	30H
IA32_LBR_0_TO_IP	38H
IA32_LBR_0_INFO	40H
...	...
IA32_LBR_[Num_LBR-1]_FROM_IP	30H+[Num_LBR-1]*24
IA32_LBR_[Num_LBR-1]_TO_IP	38H+[Num_LBR-1]*24
IA32_LBR_[Num_LBR-1]_INFO	40H+[Num_LBR-1]*24

The group size is 6\*8 bytes + Num\_LBR\*24 bytes. Software must look at IA32\_LBR\_DEPTH recorded in the group. If a fixed size was requested in the IA32\_PMC\_GPn\_CFG\_C or IA32\_PMC\_FXm\_CFG\_C register, IA32\_LBR\_DEPTH recorded in the group will indicate how many LBR entries in the group are valid (meaningful). If a variable size was requested in the IA32\_PMC\_GPn\_CFG\_C or IA32\_PMC\_FXm\_CFG\_C register, IA32\_LBR\_DEPTH recorded in the group will indicate the size of the variable portion of the LBR group.

The LBR array is preceded in the record by five additional LBR- and LER-related fields. Should a fixed number of Num\_LBRs be requested, but LBR\_DEPTH is set lower, entries beyond LBR\_DEPTH will be unmodified. IA32\_LBR\_DEPTH is included in the LBR group in a specific location.

It is possible for LBRs to be in system wide mode (IA32\_LBR\_CTL[OS=1, USR=1]) while PEBS is in user mode. PEBS will not attempt to filter out any non-user data from the LBRs, including LERs. It is up to the software to ensure that if it allows LBRs in PEBS, that the filtering conditions are appropriate.

The size of a single LBR entry is 3 fields \* 64 bits, or 24 bytes. The contents of each field is determined by the architectural LBR feature.

### 11.4.6 Performance Counters Group

Performance Counters enable performance monitoring events to be counted during processor execution. The Counters group (CNTR) enables users to snapshot the current values of select performance monitoring counters into the PEBS record. including counters other than the one that triggered the generation of the PEBS record. General-purpose (GP), fixed-function (FIXED), and performance metrics (METRICS) are covered by the Counters group. Table 11-11 provides the Counter group details.

The bits CPUID.(EAX=23H, ECX=04H):EBX.CNTR[7:4] indicate that the Counter group component subgroups are available.

IA32\_PMC\_GPn\_CFG\_C.CNTR[39:36] and IA32\_PMC\_FXm\_CFG\_C.CNTR[39:36] indicate whether to include the Counter group subgroups when this counter generates a PEBS record. Any set bit will cause the Counter group header to be included in the record.

The bits PEBS Record Format.CNTR[39:36] indicate which counter group subgroups were included in the record. If any of these bits are set, the PEBS record will include the 16-byte group header. The group header contains four 32-bit vectors, one vector per subgroup, indicating which counters are included in each subgroup. Individual counters must opt in.

CPUID.(EAX=23H, ECX=04H):EBX.ALLOW\_IN\_RECORD[3] indicates the IA32\_PMC\_GPn\_CFG\_C.ALLOW\_IN\_RECORD and IA32\_PMC\_FXm\_CFG\_C.ALLOW\_IN\_RECORD bits are available. Software should set IA32\_PMC\_GPn\_CFG\_C.ALLOW\_IN\_RECORD[35] and IA32\_PMC\_FXm\_CFG\_C.ALLOW\_IN\_RECORD[35] to include the counter's value in the PEBS record when a record is generated that includes the associated subgroup.

The ALLOW\_IN\_RECORD, METRICS, FIXED, and GP bits within the extension registers allow software to control which counters actually appear in the PEBS record.

Note that the bit PEBS Record Format.ALLOW\_IN\_RECORD[35] is reserved.

**Table 11-11. Counter Group Details**

Bit	Reserved	METRICS Subgroup	FIXED Subgroup	GP Subgroup	ALLOW_IN_RECORD
CPUID.(EAX=23H, ECX=04H):EBX	7	6	5	4	3
IA32_PMC_GPn_CFG_C	39	38	37	36	35
IA32_PMC_FXm_CFG_C					
PEBS Record Format	39	38	37	36	35
Group Header Bits	127:96	95:94	63:32	31:0	N/A

Consider the following example using general-purpose counters, where:

- IA32\_PMC\_GP0\_CFG\_C.{ALLOW=1, GP=1}
- IA32\_PMC\_GP1\_CFG\_C.ALLOW=1
- IA32\_PMC\_GP2\_CFG\_C.ALLOW=0

If general-purpose counter 0 generates a PEBS record, it includes general-purpose counter 0 and general-purpose counter 1 (but not general-purpose counter 2 because its ALLOW bit was clear).

If general-purpose counter 1 or general-purpose counter 2 generates a PEBS record, it does not include any counters because all METRICS, FIXED, and GP bits were clear for general-purpose counter 1 and general-purpose counter 2.

### 11.4.7 Fragmented Records

A PEBS record can be split into n fragments that comprise the complete record. Fragmented records can help mitigate the contiguous buffer when PEBS2GPA is used. See Section 11.5.1 for information about PEBS2GPA and Chapter 29 of the Intel® 64 and IA-32 Architectures Software Developer’s Manual, Volumes 3A, 3B, 3C, & 3D, for EPT details.

Each fragment of the complete record has a header and a subset of the groups. The first n-1 fragments will have their Continued[31] bit set to 1 to indicate that the record has additional groups in subsequent record fragments. The last fragment will have its Continued bit clear.

If there is empty space between record fragments, then either the Record Size field may indicate padding (i.e., having a value larger than the required size; refer to Section 11.4, “Records and Groups”) or a NULL record will be inserted. A NULL record is an empty record where only the Record Size field is non-zero (Group indicators, the Continued bit, and other fields are clear).

For example, suppose that a complete record consists of two fragments, record 4 and record 5, which cross an EPT page boundary as shown in Figure 11-4. In the upper part of Figure 11-4, record 4 includes some of the requested groups and padding to abut the end of the page, and it has its Continued bit set to 1. In the lower part of Figure 11-4, record 4 includes some of the requested groups with no padding (it has its Continued bit set to 1) and the Null Record abuts the end of the page. Record 5 contains the remaining groups in both instances, with the Continued bit clear.

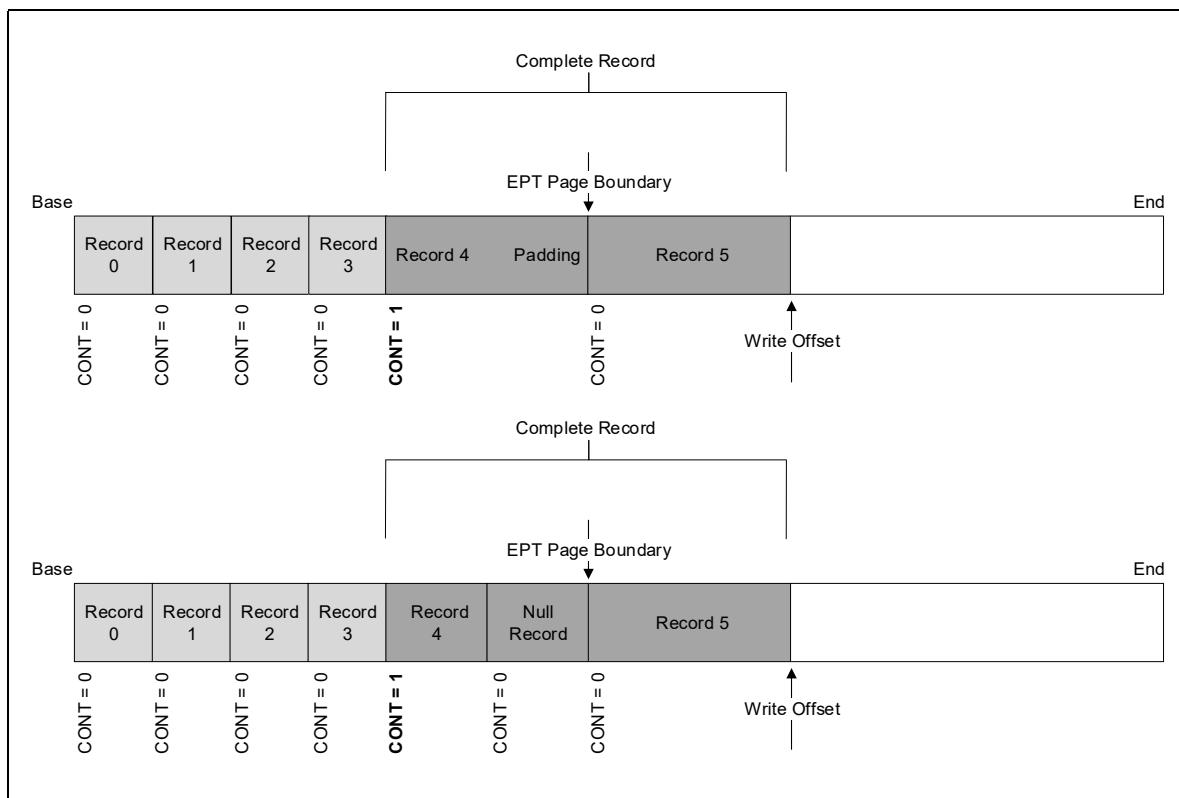

Figure 11-4. Example of a Fragmented Record

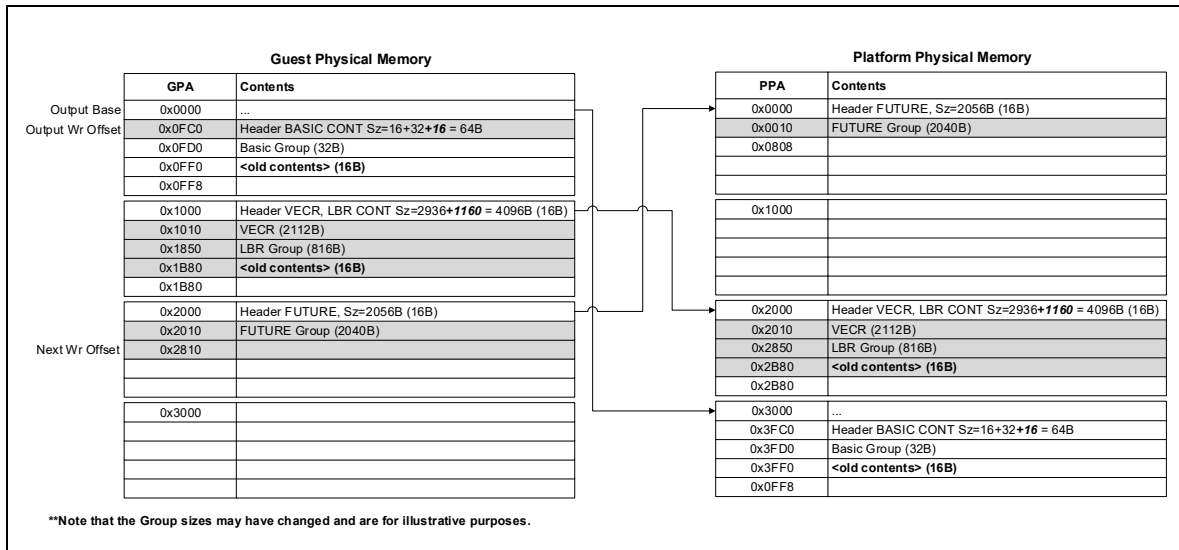

Figure 11-5. EPT Page Boundary Example with Included Padding

## 11.5 INTERACTIONS WITH OTHER PROCESSOR FEATURES

### 11.5.1 Virtual Machine Extension (VMX)

By default, PEBS operation persists across VMX transitions. However, VMCS fields have been added to enable constraining PEBS usage to within VMX non-root operation only. See details in Table 11-12.

Table 11-12. PEBS VMCS Fields

Name	Type	Bit	Behavior
PEBS Uses Guest Physical Addresses (PEBS2GPA)	Tertiary Processor-Based VM-Execution Control	12 <sup>1</sup>	This bit determines whether the PEBS buffer uses guest physical addresses.

#### NOTES:

- Definitions of Tertiary Processor-Based VM-Execution Controls. Software should consult the VMX capability MSR, IA32\_VMX\_PROCBASED\_CTL3, to determine if this bit may be set. See the Intel® 64 and IA-32 Architectures Software Developer's Manual, Volume 3D, Appendix A.3.4.

To enable the guest-only PEBS use case, a VMM should set the "PEBS Uses Guest Physical Addresses" VMCS execution control, and allocate the PEBS buffer using guest physical addresses (GPAs). Additionally, counters should be enabled only in VMX non-root operation for that guest. In other words, on VM exit from the guest, the counters should be stopped, and on VM entry back to the guest, the counters should be resumed. This ensures that the counters and the PEBS record information belong to that guest.



In this use case, the Guest owns counter/PEBS configuration, manages the PEBS output buffer, and switches the counter/PEBS state across applications inside that guest. The Host can simply pass through the PEBS and counter management handling to that guest as illustrated by Figure 11-6.

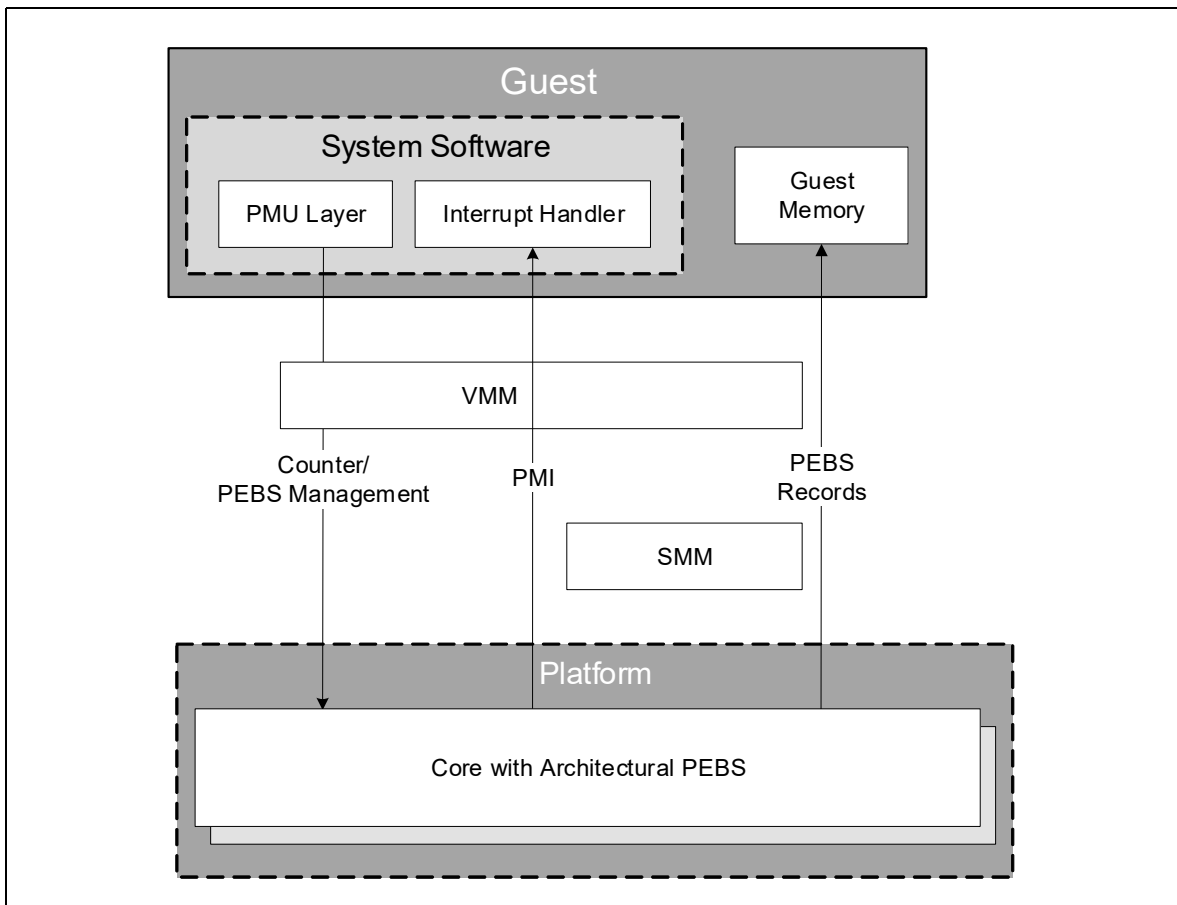

**Figure 11-6. Guest-Only PEBS: Diagram of Interactions Across Entities**

To enable the system-wide PEBS use case, a VMM should keep the PEBS Uses Guest Physical Addresses bit clear and allocate the PEBS buffer using platform physical addresses (PPAs). Additionally, counters configured for PEBS should always be enabled, possibly hidden from guests. In other words, on any VM exit or VM entry, the counters should continue counting. This ensures that the counters and the PEBS record information are system-wide.

In this use case, the host owns counter/PEBS configuration, manages the PEBS output buffer, and assures the counter/PEBS state persists across guests, as illustrated by Figure 11-7.

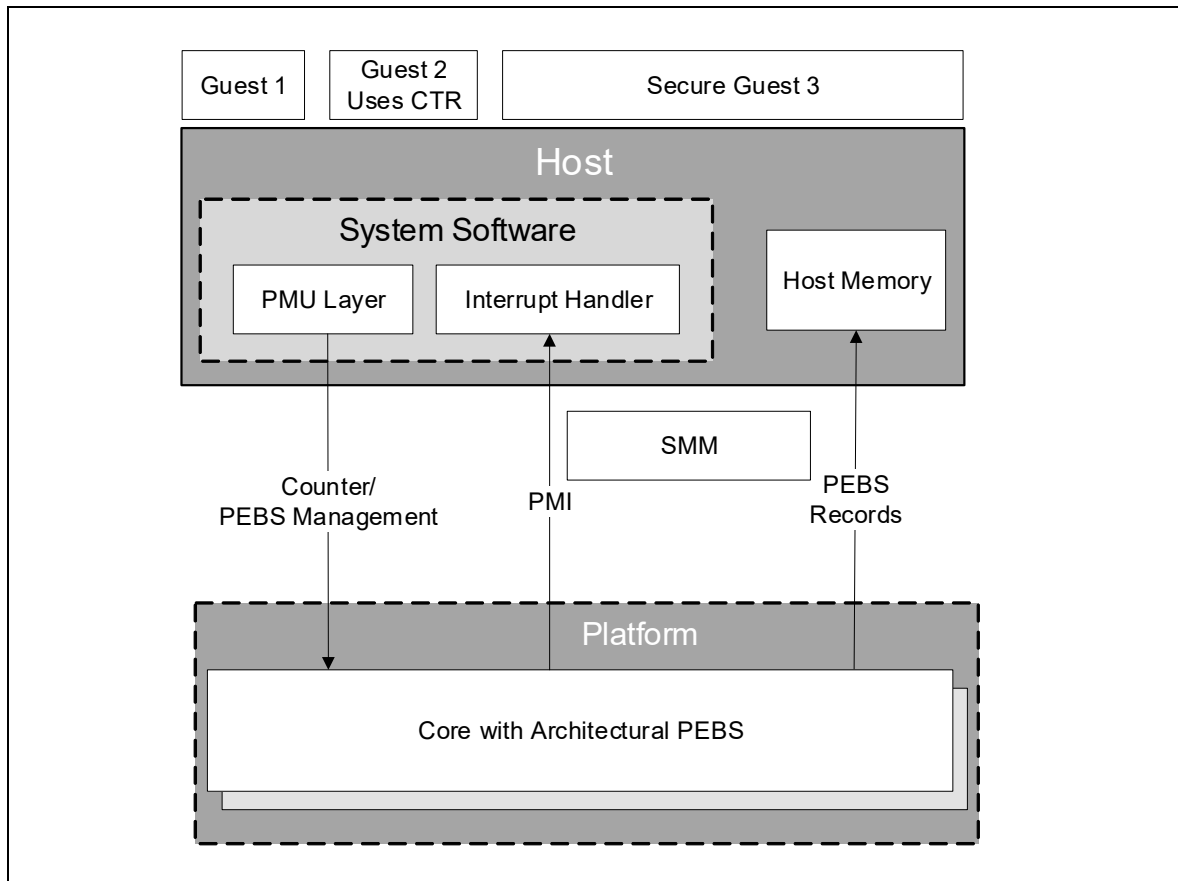

**Figure 11-7. System-Wide PEBS: Diagram of Interactions Across Entities**

Other use cases, e.g., host-only, are possible but must be managed by the VMM.

### 11.5.2 Intel® Secure Guard Extensions (Intel® SGX)

For production (opt-out) enclaves, an enclave entry freezes counters, except fixed-function counters 1 and 2 (unhalted core cycles and unhalted reference cycles, respectively). Additionally, handling any PEBS event that may occur during an enclave execution is deferred until after the enclave exit, i.e., the PEBS event would skid to the end of EEXIT/AEX. Specifically, the EventingIP field of the PEBS record would have the EENTER/ERESUME address and the Memory Access Address (MAA) field would be zero.

For non-production (opt-in) enclaves, all counters continue to count. Any PEBS event that may occur during enclave execution would be handled normally. Specifically, fields of the PEBS record would expose the non-production enclave state.

Architectural PEBS will write nothing to memory in the case where the PEBS buffer is mapped to the Processor Reserved Memory Range Register (PRMRR). Writes are directed to the abort page.

### 11.5.3 Intel® Trust Domain Extensions (Intel® TDX)

Intel TDX supports two modes of monitoring:

- TD Profiling – The trusted domain (TD) uses performance-monitoring/PEBS to profile itself.

- System Profiling – The VMM uses performance-monitoring/PEBS to profile itself plus any debuggable TDs.

For TD profiling mode, a TD may use performance-monitoring by setting the TDCS.ATTRIBUTES[PerfMon] bit. This enables a performance-monitoring-enabled TD to access all performance-monitoring MSRs. Architectural PEBS will be enumerated to the TD and the PEBS2GPA flag is set. The TD is expected to set up the PEBS buffer in TD private pages.

Architectural PEBS will not be available for TDs that are not performance-monitoring-enabled. Specifically, Leaf 23H Subleaves 4 and 5 will be cleared, and accesses to the IA32\_PEBS\_\* and IA32\_PMC\_\*\_CFG\_C MSRs will result in a #GP exception.

### 11.5.4 System Management Mode (SMM)

Performance-monitoring counters count through system management mode (SMM), unless IA32\_DEBUGCTL.FREEZE\_WHILE\_SMM\_EN = 1.

PEBS will be inhibited on opt-out #SMI, inhibit cleared on RSM. This ensures any PEBS pended during SMM will skid to end of RSM and precludes any SMM use of PEBS.

### 11.5.5 SMM-Transfer Monitor (STM)

No STM-specific support is added with Architectural PEBS. However, the STM should configure the SMM-transfer VMCS as follows:

- The “save IA32\_PERF\_GLOBAL\_CTRL” and “load IA32\_PERF\_GLOBAL\_CTRL” VM-exit controls are set to 1.
- The host IA32\_PERF\_GLOBAL\_CTRL value is zero.
- The “load IA32\_PERF\_GLOBAL\_CTRL” VM-entry control is set to 1.

These ensure that non-SMM counters are disabled on an SMM VM exit, that any PEBS pended during such a VM exit are deferred, and that non-SMM counters are re-enabled by a VM entry that returns from SMM.

An STM is free to use PEBS itself, but it should ensure that non-SMM counter configuration state is restored before a VM entry that returns from SMM.



The mnemonic MOVRS identifies a set of load instructions that carry a “read-shared” hint. Functionally, these instructions are equivalent to existing load instructions (and can be used as “drop-in” replacements) for which the read-shared hint is appropriate. From a performance point of view, the hint indicates that the data being accessed is expected to be read concurrently by multiple cores.

Intel processors are typically optimized assuming that, on a first read, data is private and is reasonably likely to be written. This assumption influences the hardware's determination of the cache locations into which data are placed on an access as well as the coherence state of the data after the access.

These determinations are especially relevant for hardware with non-inclusive last-level caches. Accessing read-shared data, i.e., data concurrently read by multiple cores, with conventional loads can cause performance issues. In particular, for both a multi-readers scenario where data starts in DRAM and a single-producer multi-consumer scenario where data starts dirty in one core's private cache, snoops are required to distribute the data to the readers.

Loads with a read-shared hint are expected to trigger uncore<sup>1</sup> behavior different from that used for conventional loads. The read-shared hint tells caches that the data is expected to be read by multiple (unspecified) cores within the socket. Thus, hardware, to the extent possible, installs the cache line into the appropriate cache(s) and in the appropriate coherence state to minimize snoops triggered by future reads.

On a cache miss, the read-shared hint may influence which cache(s) hardware installs data into, and the uncore transactions used to fetch data to the core. On a cache hit, the hint is not expected to trigger different behavior. Also, at least for currently planned implementations, the hint is not stored in the caches; hardware will act (or not) on the hint immediately. The exception to this is hardware prefetchers, which will train on the hint, and attempt to issue requests matching the presence/absence of the hint.

Mixing conventional loads and read-shared loads to the same cache line and/or access stream will behave as expected functionally. However, the cache behavior will depend on the order of the requests and the behavior of the hardware prefetchers. It is easier to predict and understand the hardware behavior if software consistently uses (or not) read-shared loads for a given access pattern.

The exception to this is phased program behavior. Software may have phases, where a given data structure is read-shared in one phase, and not in the next phase. It is expected that the different phases will use the appropriate type of load instruction, i.e., read-shared loads for the phase with read sharing and conventional loads for other phases.

Since the read-shared hint simply influences which caches hold a copy of a line and the coherence state, it does not limit how the data is accessed by software in the future. In particular, a future write to a cache line that has been read with a read-shared load instruction, by the same core that executed the load instruction or another core, will behave as expected architecturally. The performance of such a write may be worse than if the data was read with a conventional load instruction, if the read-shared load leaves caches in a state such that additional cache and/or uncore transactions are needed for the write.

The MOVRS family includes scalar, vector, and tile variants. It also includes a software prefetch instruction, PREFETCHRST2, that carries the same read-shared hint. This instruction is for applications that want to apply software prefetching to read-shared data structures.

---

1. The term “uncore” roughly equates to logic outside the CPU cores but residing on the same die.



Virtual-machine extensions (VMX) define processor-level support for virtual machines on Intel<sup>®</sup> 64 processors. This chapter specifies enhancements to VMX that may be included in future Intel processor generations.

The enhancement described in this chapter supports management of the IA32\_SPEC\_CTRL MSR across VMX transitions (saving it on VM exits and allowing it to be loaded on VM entries and VM exits).

Section 13.2 presents details of the VMCS changes supporting the new features. Section 13.2 and Section 13.3 specify how the feature affects VM entries and VM exits, respectively.

## 13.1 VMCS CHANGES

Section 13.1.1 identifies the new VMX controls that enable the new enhancements, and Section 13.1.2 enumerates the new VMCS fields that support the enhancements.

### 13.1.1 New VMX Controls

This feature introduces two new VMX controls that allow the IA32\_SPEC\_CTRL MSR to be loaded on VMX transitions:

- VM-entry control 24 is “load IA32\_SPEC\_CTRL”; see Section 13.2 for details of its use.
- Secondary VM-exit control 2 is “load IA32\_SPEC\_CTRL”; see Section 13.3 for details of its use.

### 13.1.2 New VMCS Fields

The following new 64-bit fields are defined in the VMCS:

- A new guest-state field for IA32\_SPEC\_CTRL (encoding pair 282EH/282FH). This field exists on any processor that supports the 1-setting of the “load IA32\_SPEC\_CTRL” VM-entry control (see Section 13.1.1). Its use is explained in Section 13.2 and Section 13.3.
- A new host-state field for IA32\_SPEC\_CTRL (encoding pair 2C1AH/2C1BH). This field exists on any processor that supports the 1-setting of the “load IA32\_SPEC\_CTRL” VM-exit control. Its use is explained in Section 13.3.

## 13.2 CHANGES TO VM ENTRIES

This section describes changes to the operation of VM entries.

### 13.2.1 Host-State Checking

If the “load IA32\_SPEC\_CTRL” VM-exit control is 1, VM entry checks the value of the IA32\_SPEC\_CTRL field in the host-state area. If the value that is not valid for that MSR (e.g., because it sets a reserved bit), VM entry fails as is normally the case when checking host state.

### 13.2.2 Guest-State Checking

If the “load IA32\_SPEC\_CTRL” VM-entry control is 1, VM entry checks the value of the IA32\_SPEC\_CTRL field in the guest-state area. If the value that is not valid for that MSR (e.g., because it sets a reserved bit), VM entry fails as is normally the case when checking guest state.

### 13.2.3 Guest-State Loading

If the “load IA32\_SPEC\_CTRL” VM-entry control is 1, VM entry loads the IA32\_SPEC\_CTRL MSR with the value of the IA32\_SPEC\_CTRL field in the guest-state area of the VMCS.

This load of the MSR will have any side effects that would occur normally had the MSR been written with that value.

Behavior is undefined if the IA32\_SPEC\_CTRL MSR is included in the VM-entry MSR-load area. Software should avoid including it there.

## 13.3 CHANGES TO VM EXITS

This section describes changes to the operation of VM exits related to the enhancements described in this chapter.

### 13.3.1 Saving Guest State

On processors that support the 1-setting of the “load IA32\_SPEC\_CTRL” VM-entry control, every VM exit saves the value of the IA32\_SPEC\_CTRL MSR into the IA32\_SPEC\_CTRL field in the guest-state area of the VMCS.

Behavior is undefined if the IA32\_SPEC\_CTRL MSR is included in the VM-exit MSR-store area. Software should avoid including it there.

### 13.3.2 Loading Host State

If the “load IA32\_SPEC\_CTRL” VM-exit control is 1, VM exit loads the IA32\_SPEC\_CTRL MSR from the value of the IA32\_SPEC\_CTRL field in the host-state area of the VMCS.

This load of the MSR will have any side effects that would occur normally had the MSR been written with that value.



## CHAPTER 14 INTEL® SOFTWARE GUARD EXTENSIONS FEATURE UPDATES

Intel® Software Guard Extensions (Intel® SGX) is a set of instructions and mechanisms for memory accesses in Intel® Architecture processors. This chapter covers updates of data structures and instructions for SGX support of 256-bit cryptography and enabling local attestation between SGX and TDX.

Further details of the Intel® SGX can be found in the Intel® 64 and IA-32 Architectures Software Developers Manual, Volume 3B. In general, various functionality is encoded as leaf functions within the ENCLS (supervisor), ENCLU (user), and the ENCLV (virtualization operation) instruction mnemonics. Different leaf functions are encoded by specifying an input value in the EAX register of the respective instruction mnemonic.

Further details of Intel® Trust Domain Extensions (Intel® TDX) can be found in the Intel® Trust Domain CPU Architectural Extensions specification.

### 14.1 ENCLAVE INSTRUCTIONS AND INTEL® SGX

The enclave instructions available with Intel SGX are organized as leaf functions under three instruction mnemonics: ENCLS (supervisor), ENCLU (user), and ENCLV (virtualization operation). Each leaf function uses EAX to specify the leaf function index, and may require additional implicit input registers as parameters. The use of EAX is implied implicitly by the ENCLS, ENCLU, and ENCLV instructions; ModR/M byte encoding is not used with ENCLS, ENCLU, and ENCLV. The use of additional registers does not use ModR/M encoding and is implied implicitly by the respective leaf function index.

Each leaf function index is also associated with a unique, leaf-specific mnemonic. A long-form expression of Intel SGX instruction takes the form of ENCLx[LEAF\_MNEMONIC], where 'x' is either 'S', 'U', or 'V'. The long-form expression provides clear association of the privilege-level requirement of a given "leaf mnemonic". For simplicity, the unique "Leaf\_Mnemonic" name is used (omitting the ENCLx for convenience) throughout in this document.

**Table 14-1. Supervisor and User Mode Enclave Instruction Leaf Function in Long-Form of 256-bit SGX**

Supervisor Instruction	Description	User Instruction	Description
		ENCLU[EGETKEY256]	Create a 256-bit cryptographic key.
		ENCLU[EREPORT2]	Create a cryptographic report that contains SHA384 measurements.

### 14.2 INTEL® SGX RESOURCE ENUMERATION LEAVES

If CPUID.(EAX=07H, ECX=0H):EBX.SGX[bit 02]=1, the processor also supports querying CPUID with EAX=12H on Intel SGX resource capability and configuration. If CPUID.(EAX=12H, ECX=0H):EAX.256BITSGX[bit 12] = 1, Intel® SGX supports leaf functions EGETKEY256 and EREPORT2, MSRs IA32\_SGXLEPUBKEYHASH[4,5] and MSR IA32\_SGXLECONFIG.

If CPUID.(EAX=12H, ECX=00H):EAX.256BITSGX[bit 12] = 1, SGX Launch Control can be configured to require a stronger HMAC-SHA256 Message Authentication Code rather than the default AES128-CMAC. The IA32\_SGXLECONFIG MSR configures this option.

### 14.3 INTEL® SGX MSR UPDATES

**Table 14-2. IA-32 Architectural MSR Updates for Intel® SGX**

Register Address: Hex, Decimal		Architectural MSR Name (Former MSR Name)	
Bit Fields	MSR/Bit Description		Comment
Register Address: 8AH, 138		IA32_SGXLECONFIG	
IA32_SGXLECONFIG (R/W) Additional SGX Launch Control configuration.		Read permitted if CPUID.(EAX=12H,ECX=0H): EAX[0]=1 AND CPUID.(EAX=07H, ECX=0H):ECX[30]=1 AND CPUID.(EAX=12H,ECX=0H): EAX[12]=1  Write permitted if CPUID.(EAX=12H,ECX=0H): EAX[0]=1 AND CPUID.(EAX=12H,ECX=0H): EAX[12]=1 AND IA32_FEATURE_CONTROL[17]=1 AND IA32_FEATURE_CONTROL[0]=1.	
0	Launch Control Key Strength 0: 128-bit (AES128-CMAC) 1: 256-bit (HMAC-SHA256)		
63:1	Reserved.		
Register Address: 90H, 144		IA32_SGXLEPUBKEYHASH4	
IA32_SGXLEPUBKEYHASH[319:256] (R/W) Bits 319:256 of the SHA256 digest of the SIGSTRUCT.MODULUS for SGX Launch Enclave. On reset, the default value is the digest of Intel's signing key.		Read permitted if CPUID.(EAX=12H,ECX=0H): EAX[0]=1 AND CPUID.(EAX=07H,ECX=0H): ECX[30]=1 AND CPUID.(EAX=12H,ECX=0H): EAX[12]=1  Write permitted if CPUID.(EAX=12H,ECX=0H): EAX[0]=1 AND CPUID.(EAX=12H,ECX=0H): EAX[12]=1 AND IA32_FEATURE_CONTROL[17]=1 AND IA32_FEATURE_CONTROL[0] = 1.	
Register Address: 91H, 145		IA32_SGXLEPUBKEYHASH5	
IA32_SGXLEPUBKEYHASH[383:320] (R/W) Bits 383:320 of the SHA256 digest of the SIGSTRUCT.MODULUS for SGX Launch Enclave. On reset, the default value is the digest of Intel's signing key.		Same comment in MSR listing for IA32_SGXLEPUBKEYHASH4 (MSR address 90H, 144) applies here.	

## 14.4 MEMORY ACCESSES

**Table 14-3. List of Implicit and Explicit Memory Access by Intel® SGX Enclave Instructions**

Instr. Leaf	Enum.	Explicit 1	Explicit 2	Explicit 3	Implicit
EACCEPT	SGX2	SECINFO	EPCPAGE		SECS
EACCEPTCOPY	SGX2	SECINFO	EPCPAGE (Src)	EPCPAGE (Dst)	
EADD	SGX1	PAGEINFO and linked structures	EPCPAGE		
EAUG	SGX2	PAGEINFO and linked structures	EPCPAGE		SECS
EBLOCK	SGX1	EPCPAGE			SECS
ECREATE	SGX1	PAGEINFO and linked structures	EPCPAGE		
EDBGDR	SGX1	EPCADDR	Destination		SECS
EDBGWR	SGX1	EPCADDR	Source		SECS
EDECVIRTCHILD	OVERSUB	EPCPAGE	SECS		
EENTER	SGX1	TCS and linked SSA			SECS
EEXIT	SGX1				SECS, TCS
EEXTEND	SGX1	SECS	EPCPAGE		
EGETKEY	SGX1	KEYREQUEST	KEY		SECS
EGETKEY256	256BITSGX	KEYREQUEST	KEY		SECS
EINCVIRTCHILD	OVERSUB	EPCPAGE	SECS		
EINIT	SGX1	SIGSTRUCT	SECS	EINITTOKEN	
ELDB/ELDU	SGX1	PAGEINFO and linked structures, PCMD	EPCPAGE	VAPAGE	
ELDBC/ELDUC	OVERSUB	PAGEINFO and linked structures	EPCPAGE	VAPAGE	
EMODPE	SGX2	SECINFO	EPCPAGE		
EMODPR	SGX2	SECINFO	EPCPAGE		SECS
EMODT	SGX2	SECINFO	EPCPAGE		SECS
EPA	SGX1	EPCADDR			
ERDINFO	OVERSUB	RDINFO	EPCPAGE		
EREMOVE	SGX1	EPCPAGE			SECS
EREPORT	SGX1	TARGETINFO	REPORTDATA	OUTPUTDATA	SECS
EREPORT2	256BITSGX	TARGETINFO	REPORTDATA	OUTPUTDATA	SECS
ERESUME	SGX1	TCS and linked SSA			SECS
ESETCONTEXT	OVERSUB		SECS	ContextValue	
ETRACK	SGX1	EPCPAGE			
ETRACKC	OVERSUB		EPCPAGE		
EWB	SGX1	PAGEINFO and linked structures, PCMD	EPCPAGE	VAPAGE	SECS
Asynchronous Enclave Exit*					SECS, TCS, SSA

\*Details of Asynchronous Enclave Exit (AEX) is described in Section 38.4

## 14.5 INTEL® SGX DATA STRUCTURES

### 14.5.1 SGX Enclave Control Structure (SECS)

The SECS data structure requires 4K-bytes alignment.

MRENCLAVE384 and MRSIGNER384 are added to the Reserved field, which consists of:

- EID: An 8 byte Enclave Identifier. Its location is implementation specific.
- PAD: A 352 bytes padding pattern from the Signature (used for key derivation strings). It's location is implementation specific.
- VIRTCHILD CNT: An 8 byte Count of virtual children that have been paged out by a VMM. Its location is implementation specific.
- ENCLAVECONTEXT: An 8 byte Enclave context pointer. Its location is implementation specific.
- ISVFAMILYID: A 16 byte value assigned to identify the family of products the enclave belongs to.
- ISVEXTPRODID: A 16 byte value assigned to identify the product identity of the enclave.
- MRENCLAVE384: Measurement Register of the enclave build process.
- MRSIGNER384: Measurement Register extended with the public key that verified the enclave. See Section 14.5.3, "Enclave Signature Structure (SIGSTRUCT)" for format.
- The remaining 3130 bytes are reserved area.

The Reserved field is at offset 262 and the entire 3834-byte field must be cleared prior to executing ECREATE.

### 14.5.2 Attributes

The ATTRIBUTES data structure is comprised of bit-granular fields that are used in the SECS, the REPORT and the KEYREQUEST structures. CPUID.(EAX=12H, ECX=1) enumerates a bitmap of permitted 1-setting of bits in ATTRIBUTES.

**Table 14-4. Layout of ATTRIBUTES Structure**

Field	Bit Position	Description
INIT	0	This bit indicates if the enclave has been initialized by EINIT. It must be cleared when loaded as part of ECREATE. For EREPORT instruction, TARGET_INFO.ATTRIBUTES[EINIT] must always be 1 to match the state after EINIT has initialized the enclave.
DEBUG	1	If 1, the enclave permit debugger to read and write enclave data using EDBGD and EDBGW.
MODE64BIT	2	Enclave runs in 64-bit mode.
RESERVED	3	Must be Zero.
PROVISIONKEY	4	Provisioning Key is available from EGETKEY.
EINITTOKEN_KEY	5	EINIT token key is available from EGETKEY.
CET	6	Enable CET attributes. When CPUID.(EAX=12H, ECX=1);EAX[6] is 0 this bit is reserved and must be 0.
KSS	7	Key Separation and Sharing Enabled.
RESERVED	9:8	Must be zero.
AEXNOTIFY	10	The bit indicates that threads within the enclave may receive AEX notifications.
SHA384	11	This bit enables SHA384 measurements for the enclave.
RESERVED	63:12	Must be zero.
XFRM	127:64	XSAVE Feature Request Mask. See Section 40.7.

### 14.5.3 Enclave Signature Structure (SIGSTRUCT)

SIGSTRUCT is a structure created and signed by the enclave developer that contains information about the enclave. SIGSTRUCT is processed by the EINIT leaf function to verify that the enclave was properly built.

SIGSTRUCT includes ENCLAVEHASH as a SHA256 or SHA384 digest, as defined in FIPS PUB 180-4. The digests are byte strings of length 32 or 48 bytes. Each of the 8 HASH Dwords is stored in little-endian order.

SIGSTRUCT includes four 3072-bit integers (MODULUS, SIGNATURE, Q1, Q2). Each such integer is represented as a byte string of length 384, with the most significant byte at the position "offset + 383", and the least significant byte at position "offset".

The (3072-bit integer) SIGNATURE should be an RSA signature, where: a) the RSA modulus (MODULUS) is a 3072-bit integer; b) the public exponent is set to 3; c) the signing procedure uses the EMSA-PKCS1-v1.5 format with DER encoding of the "DigestInfo" value as specified in of PKCS#1 v2.1/RFC 3447.

The 3072-bit integers Q1 and Q2 are defined by:

$q1 = \text{floor}(\text{Signature}^2 / \text{Modulus});$

$q2 = \text{floor}((\text{Signature}^3 - q1 * \text{Signature} * \text{Modulus}) / \text{Modulus});$

SIGSTRUCT must be page aligned

In column 5 of Table 14-5, 'Y' indicates that this field should be included in the signature generated by the developer.

**Table 14-5. Layout of Enclave Signature Structure (SIGSTRUCT)**

Field	OFFSET (Bytes)	Size (Bytes)	Description	Signed
HEADER	0	16	Must be byte stream 06000000E100000000001000000000H	Y
VENDOR	16	4	Intel Enclave: 00008086H Non-Intel Enclave: 00000000H	Y
DATE	20	4	Build date is yyyyymmdd in hex: yyyy=4 digit year, mm=1-12, dd=1-31	Y
HEADER2	24	16	Must be byte stream 01010000600000006000000001000000H	Y
SWDEFINED	40	4	Available for software use.	Y
SIGHASHTYPE	44	4	If this field is 0, SIGHASHTYPE is SHA256. If this field is 1, SIGHASHTYPE is SHA384.	Y
RESERVED	48	80	Must be zero.	Y
MODULUS	128	384	Module Public Key (keylength=3072 bits).	N
EXPONENT	512	4	RSA Exponent = 3.	N
SIGNATURE	516	384	Signature over Header and Body.	N
MISCSELECT <sup>1</sup>	900	4	Bit vector specifying Extended SSA frame feature set to be used.	Y
MISCMASK	904	4	Bit vector mask of MISCSELECT to enforce.	Y
CET_ATTRIBUTES	908	1	When CPUID.(EAX=12H, ECX=1):EAX[6] is 1, this field provides the Enclave CET attributes that must be set. When CPUID.(EAX=12H, ECX=1):EAX[6] is 0, this field is reserved and must be 0.	Y
CET_ATTRIBUTES_MASK	909	1	When CPUID.(EAX=12H, ECX=1):EAX[6] is 1, this field provides the Mask of CET attributes to enforce. When CPUID.(EAX=12H, ECX=1):EAX[6] is 0, this field is reserved and must be 0.	Y
RESERVED	910	2	Must be zero.	Y
ISVFAMILYID	912	16	ISV assigned Product Family ID.	Y

**Table 14-5. Layout of Enclave Signature Structure (SIGSTRUCT) (Contd.)**

Field	OFFSET (Bytes)	Size (Bytes)	Description	Signed
ATTRIBUTES	928	16	Enclave Attributes that must be set.	Y
ATTRIBUTEMASK	944	16	Mask of Attributes to enforce.	Y
ENCLAVEHASH	960	32	MRENCLAVE of enclave this structure applies to.	Y
RESERVED	992	16	Must be zero.	Y
ISVEXTPRODID	1008	16	ISV assigned extended Product ID.	Y
ISVPRODID	1024	2	ISV assigned Product ID.	Y
ISVSVN	1026	2	ISV assigned SVN (security version number).	Y
RESERVED	1028	12	Must be zero.	N
Q1	1040	384	Q1 value for RSA Signature Verification.	N
Q2	1424	384	Q2 value for RSA Signature Verification.	N

**NOTES:**

- If CPUID.(EAX=12H, ECX=0):EBX[31:0] = 0, MISCSELECT must be 0.

### 14.5.4 EINIT Token Structure (EINITTOKEN)

The EINIT token is used by EINIT to verify that the enclave is permitted to launch. EINIT token is generated by an enclave in possession of the EINITTOKEN key (the Launch Enclave).

EINIT token must be 512-Byte aligned.

**Table 14-6. Layout of EINIT Token (EINITTOKEN)**

Field	OFFSET (Bytes)	Size (Bytes)	MACed	Description
VALID	0	4	Y	Bit 0: If this bit is 1, the token is valid; if 0, the token is invalid. Bit 1: LE256. If this bit is 1, 256-bit security is on the token; if 0, 128-bit security is on the token. All other bits reserved.
RESERVED	4	44	Y	Must be zero.
ATTRIBUTES	48	16	Y	ATTRIBUTES of the Enclave.
MRENCLAVE	64	48	Y	MRENCLAVE of the Enclave. SHA256 digests must be aligned to offset 64, and offsets 111:96 must be zero.
RESERVED	112	16	Y	Reserved.
MRSIGNER	128	48	Y	MRSIGNER of the Enclave. SHA256 digests must be aligned to offset 64, and offsets 111:96 must be zero.
RESERVED	176	16	Y	Reserved.
CPUSVNLE	192	16	N	Launch Enclave's CPUSVN.
ISVPROIDL	208	2	N	Launch Enclave's ISVPRODID.
ISVSVNLE	210	2	N	Launch Enclave's ISVSVN.
CET_MASKED_ATTRIBUTES_LE	212	1	N	When CPUID.(EAX=12H, ECX=1):EAX[6] is 1, this field provides the Launch enclaves masked CET attributes. This should be set to LE's CET_ATTRIBUTES masked with CET_ATTRIBUTES_MASK of the LE's KEYREQUEST. When CPUID.(EAX=12H, ECX=1):EAX[6] is 0, this field is reserved.
RESERVED	213	23	N	Reserved.

Table 14-6. Layout of EINIT Token (EINITTOKEN) (Contd.)

Field	OFFSET (Bytes)	Size (Bytes)	MACed	Description
MASKEDMISCSELECTLE	236	4		Launch Enclave's MASKEDMISCSELECT: set by the LE to the resolved MISCSELECT value, used by EGETKEY (after applying KEYREQUEST's masking).
MASKEDATTRIBUTESLE	240	16		Launch Enclave's MASKEDATTRIBUTES: This should be set to the LE's ATTRIBUTES masked with ATTRIBUTEMASK of the LE's KEYREQUEST.
KEYID (or HMAC)	256	32		If VALID[1]=0, this is the value for key wear-out protection. If VALID[1]=1, this field is the value of the 256-bit Hash Message Authentication Code of the token using EINITTOKEN_KEY.
MAC	288	16		If VALID[1]=0, this field is used for the 128-bit Message Authentication Code on EINITTOKEN using EINITTOKEN_KEY. If VALID[1]=1, this field must be zero.

### 14.5.5 REPORT2 (REPORT2)

The REPORT2 structure is the output of the ENCLU[EREPORT2] leaf function. REPORT2.TEEINFO includes enclave properties, measurements, and important values from the SECS. The measurements are integrity protected using an HMAC in REPORTMACSTRUCT. The REPORTMACSTRUCT.TEEINFOHASH is a hash of the REPORT2.TEEINFO establishing a binding between the TEEINFO and the MAC.

Table 14-7. Layout of REPORT2

Field	OFFSET (Bytes)	Size (Bytes)	Description
REPORTMACSTRUCT	0	256	Report MAC structure.
TEEINFO	256	512	Enclave measurements.
RESERVED	768	256	Zero.

#### 14.5.5.1 REPORT MAC STRUCTURE (REPORTMACSTRUCT)

REPORTMACSTRUCT is the first field in REPORT2 and SEAMREPORT. It is MAC-protected and contains hashes of the remainder of the report structure, which includes the TEE's measurements and the measurements of additional TCB elements not reflected in REPORTMACSTRUCT.CPUSVN.

Software verifying a REPORT2 or SEAMREPORT structure should first confirm that REPORTMACSTRUCT.TEE\_INFO\_HASH equals the SHA384(TEEINFO). If REPORTMACSTRUCT.TEE\_TCB\_INFO\_HASH is not zero, then software confirms REPORTMACSTRUCT.TEE\_TCB\_INFO\_HASH equals the SHA384(TEE\_TCB\_INFO). Then, software uses ENCLU[EVERIFYREPORT2] to verify the integrity of the REPORTMACSTRUCT. If all checks pass, the measurements in the structure describe a TEE on this platform.

The size of REPORTMACSTRUCT is 256 bytes.

Table 14-8. Layout of REPORTMACSTRUCT

Field	OFFSET (Bytes)	Size (Bytes)	Description
REPORTTYPE	0	4	Type header structure.
RESERVED	4	12	Zero.
CPUSVN	16	16	Security version number of the processor.
TEE_TCB_INFO_HASH	32	48	SEAM: SHA384 of TCC_TCB_INFO SGX: 0000 ... 0000H

**Table 14-8. Layout of REPORTMACSTRUCT (Contd.)**

Field	OFFSET (Bytes)	Size (Bytes)	Description
TEE_INFO_HASH	80	48	SHA384 of TEE type-specific structure containing the measurements of that TEE.
REPORTDATA	128	64	Set of data used for communication between the TEE and relying party.
RESERVED	192	32	Must be zero.
MAC	224	32	HMAC-SHA256 over the REPORTMACSTRUCT using the Report2 key.

#### 14.5.5.2 REPORT TYPE (REPORTTYPE)

REPORTTYPE describes the contents of REPORT2 or SEAMREPORT and is found in the report's REPORTMACSTRUCT.

**Table 14-9. Layout of REPORT2**

Field	OFFSET (Bytes)	Size (Bytes)	Description
TYPE	0	1	Trusted Execution Environment (TEE) Type: 00H: SGX 81H: SEAM-based TEE
SUBTYPE	1	1	TYPE-specific subtype.
VERSION	2	1	TYPE-specific version.
RESERVED	3	1	Zero.

#### 14.5.5.3 SGX TEEINFO (TEEINFO)

**Table 14-10. Layout of REPORTMACSTRUCT**

Field	OFFSET (Bytes)	Size (Bytes)	Description
MISCSELECT	0	4	SSA Frame extended feature set.
ISVPRODID	4	2	Enclave Product ID.
ISVSVN	6	2	Security version of the enclave.
CONFIGSVN	8	2	Value provided by software indicating expected security version of enclave's configuration.
RESERVED	10	6	Zero.
ISVEXTPRODID	16	16	Value of SECS.ISVEXTPRODID.
ATTRIBUTES	32	16	Values of the attributes flags for the enclave. See Section 14.5.2.
MRENCLAVE	48	32	Value of SECS.MRENCLAVE.
RESERVED	80	32	Zero.
MRSIGNER	112	32	Value of SECS.MRSIGNER.
RESERVED	144	32	Zero.
CONFIGID	176	64	Value provided by software to identify enclave's configuration.
ISVFAMILYID	240	16	Value of SECS.ISVFAMILYID.
MRENCLAVE384	256	48	SECS.MRENCLAVE384
MRSIGNER384	304	48	SECS.MRSIGNER384
RESERVED	352	160	Zero.



## 14.5.6 REPORT2.REPORTMACSTRUCT.REPORTDATA

The REPORTDATA is a 64-byte data structure provided by the enclave and included in REPORT2. It can be used to securely pass information from the enclave to the target enclave.

## 14.6 INTEL® SGX INSTRUCTION SYNTAX AND OPERATION

ENCLS, ENCLU, and ENCLV instruction mnemonics for all leaf functions are covered in this section.

For all instructions, the value of CS.D is ignored; addresses and operands are 64 bits in 64-bit mode and are otherwise 32 bits. Aside from EAX specifying the leaf number as input, each instruction leaf may require all or some subset of the RBX/RCX/RDX as input parameters. Some leaf functions may return data or status information in one or more of the general purpose registers.

### 14.6.1 ENCLU Register Usage Summary

Table 14-11 summarizes the implicit register usage of user mode enclave instructions.

**Table 14-11. Register Usage of Unprivileged Enclave Instruction Leaf Functions**

Instr. Leaf	EAX	RBX	RCX	RDX
EREPOR	00H (In)	TARGETINFO (In, EA)	REPORTDATA (In, EA)	OUTPUTDATA (In, EA)
EGETKEY	01H (In)	KEYREQUEST (In, EA)	KEY (In, EA)	
EENTER	02H (In)	TCS (In, EA)	AEP (In, EA)	
	RBX.CSSA (Out)		Return (Out, EA)	
ERESUME	03H (In)	TCS (In, EA)	AEP (In, EA)	
EEXIT	04H (In)	Target (In, EA)	Current AEP (Out)	
EACCEPT	05H (In)	SECINFO (In, EA)	EPCPAGE (In, EA)	
EMODPE	06H (In)	SECINFO (In, EA)	EPCPAGE (In, EA)	
EACCEPTCOPY	07H (In)	SECINFO (In, EA)	EPCPAGE (In, EA)	EPCPAGE (In, EA)
EDECCSSA	09H (In)			
EREPOR2	0AH (In)	REPORTDATA (In, EA)	OUTPUTDATA (In, EA)	REPORT2 Subtype
EGETKEY256	0BH (In)	KEYREQUEST (In, EA)	KEY (In, EA)	

EA: Effective Address

### 14.6.2 Information and Error Codes

Information and error codes are reported by various instruction leaf functions to show an abnormal termination of the instruction or provide information which may be useful to the developer. Table 14-12 shows the various codes and the instruction which generated the code. Details of the meaning of the code is provided in the individual instruction.

**Table 14-12. Error or Information Codes for Intel® SGX Instructions**

Name	Value	Returned By
No Error	0	
SGX_INVALID_SIG_STRUCT	1	EINIT
SGX_INVALID_ATTRIBUTE	2	EINIT, EGETKEY
SGX_BLKSTATE	3	EBLOCK
SGX_INVALID_MEASUREMENT	4	EINIT

**Table 14-12. Error or Information Codes for Intel® SGX Instructions**

Name	Value	Returned By
SGX_NOTBLOCKABLE	5	EBLOCK
SGX_PG_INVLD	6	EBLOCK, ERDINFO, ETRACKC
SGX_EPC_PAGE_CONFLICT	7	EBLOCK, EMODPR, EMODT, ERDINFO, EDECVIRTCHILD, EINCVIRTUALCHILD, ELDBC, ELDUC, ESETCONTEXT, ETRACKC, EUPDATESVN
SGX_INVALID_SIGNATURE	8	EINIT
SGX_MAC_COMPARE_FAIL	9	ELDB, ELDU, ELDBC, ELDUC
SGX_PAGE_NOT_BLOCKED	10	EWB
SGX_NOT_TRACKED	11	EWB, EACCEPT
SGX_VA_SLOT_OCCUPIED	12	EWB
SGX_CHILD_PRESENT	13	EWB, EREMOVE
SGX_ENCLAVE_ACT	14	EREMOVE
SGX_ENTRYEPOCH_LOCKED	15	EBLOCK
SGX_INVALID_EINITTOKEN	16	EINIT
SGX_PREV_TRK_INCMPL	17	ETRACK, ETRACKC
SGX_PG_IS_SECS	18	EBLOCK
SGX_PAGE_ATTRIBUTES_MISMATCH	19	EACCEPT, EACCEPTCOPY
SGX_PAGE_NOT_MODIFIABLE	20	EMODPR, EMODT
SGX_PAGE_NOT_DEBUGGABLE	21	EDBGRD, EDBGWR
SGX_INVALID_COUNTER	25	EDECVIRTCHILD
SGX_PG_NONEPC	26	ERDINFO
SGX_TRACK_NOT_REQUIRED	27	ETRACKC
SGX_INSUFFICIENT_ENTROPY	29	EUPDATESVN
SGX_EPC_NOT_READY	30	EUPDATESVN
SGX_NO_UPDATE	31	EUPDATESVN
SGX_INVALID_CPUSVN	32	EINIT, EGETKEY
SGX_INVALID_REPORT_SUBTYPE	33	EREPORT2
SGX_INVALID_ISVSVN	64	EGETKEY
SGX_UNMASKED_EVENT	128	EINIT
SGX_INVALID_KEYNAME	256	EGETKEY

### 14.6.3 Internal CREGs

The CREGs as shown in Table 5-4 are hardware specific registers used in this document to indicate values kept by the processor. These values are used while executing in enclave mode or while executing an Intel SGX instruction. These registers are not software visible and are implementation specific. The values in Table 14-13 appear at various places in the pseudo-code of this document. They are used to enhance understanding of the operations.

**Table 14-13. List of Internal CREG**

Name	Size (Bits)	Scope
CR_ENCLAVE_MODE	1	LP
CR_DBGOPTIN	1	LP
CR_TCS_LA	64	LP
CR_TCS_PA	64	LP

Table 14-13. List of Internal CREG

Name	Size (Bits)	Scope
CR_ACTIVE_SECS	64	LP
CR_EL RANGE	128	LP
CR_SAVE_TF	1	LP
CR_SAVE_FS	64	LP
CR_GPR_PA	64	LP
CR_XSAVE_PAGE_n	64	LP
CR_SAVE_DR7	64	LP
CR_SAVE_PERF_GLOBAL_CTRL	64	LP
CR_SAVE_DEBUGCTL	64	LP
CR_SAVE_PEBS_ENABLE	64	LP
CR_CPUSVN	128	PACKAGE
CR_SGXOWNER EPOCH	128	PACKAGE
CR_SAVE_XCRO	64	LP
CR_SGX_ATTRIBUTES_MASK	128	LP
CR_PAGING_VERSION	64	PACKAGE
CR_VERSION_THRESHOLD	64	PACKAGE
CR_NEXT_EID	64	PACKAGE
CR_BASE_PK	256	PACKAGE
CR_SEAL_FUSES	128	PACKAGE
CR_CET_SAVE_AREA_PA	64	LP
CR_ENCLAVE_SS_TOKEN_PA	64	LP
CR_SAVE_IA32_U_CET	64	LP
CR_SAVE_SSP	64	LP
CR_REPORT2_KEY	256	PACKAGE

#### 14.6.4 Intel® SGX Instructions Concurrency Tables

Table 14-14. Base Concurrency Restrictions

Leaf	Parameter		Base Concurrency Restrictions		
			Access	On Conflict	SGX_CONFLICT VM Exit Qualification
EACCEPT	Target	[DS:RCX]	Shared	#GP	
	SECINFO	[DS:RBX]	Concurrent		
EACCEPTCOPY	Target	[DS:RCX]	Concurrent		
	Source	[DS:RDX]	Concurrent		
	SECINFO	[DS:RBX]	Concurrent		
EADD	Target	[DS:RCX]	Exclusive	#GP	EPC_PAGE_CONFLICT_EXCEPTION
	SECS	[DS:RBX]PAGEINFO. SECS	Shared	#GP	

**Table 14-14. Base Concurrency Restrictions**

Leaf	Parameter		Base Concurrency Restrictions		
			Access	On Conflict	SGX_CONFLICT VM Exit Qualification
EAUG	Target	[DS:RCX]	Exclusive	#GP	EPC_PAGE_CONFLICT_EXCEPTION
	SECS	[DS:RBX]PAGEINFO. SECS	Shared	#GP	
EBLOCK	Target	[DS:RCX]	Shared	SGX_EPC_PAGE _CONFLICT	
ECREATE	SECS	[DS:RCX]	Exclusive	#GP	EPC_PAGE_CONFLICT_EXCEPTION
EDBGGRD	Target	[DS:RCX]	Shared	#GP	
EDBGWR	Target	[DS:RCX]	Shared	#GP	
EDECVIRTCHILD	Target	[DS:RBX]	Shared	SGX_EPC_PAGE _CONFLICT	
	SECS	[DS:RCX]	Concurrent		
EENTERTCS	SECS	[DS:RBX]	Shared	#GP	
EEXIT			Concurrent		
EEXTEND	Target	[DS:RCX]	Shared	#GP	
	SECS	[DS:RBX]	Concurrent		
EGETKEY/EGETK EY256	KEYREQUEST	[DS:RBX]	Concurrent		
	OUTPUTDATA	[DS:RCX]	Concurrent		
EINCVIRTCHILD	Target	[DS:RBX]	Shared	SGX_EPC_PAGE _CONFLICT	
	SECS	[DS:RCX]	Concurrent		
EINIT	SECS	[DS:RCX]	Shared	#GP	
ELDB/ELDU	Target	[DS:RCX]	Exclusive	#GP	EPC_PAGE_CONFLICT_EXCEPTION
	VA	[DS:RDX]	Shared	#GP	
	SECS	[DS:RBX]PAGEINFO. SECS	Shared	#GP	
EDLBC/ELDUC	Target	[DS:RCX]	Exclusive	SGX_EPC_PAGE _CONFLICT	EPC_PAGE_CONFLICT_ERROR
	VA	[DS:RDX]	Shared	SGX_EPC_PAGE _CONFLICT	
	SECS	[DS:RBX]PAGEINFO. SECS	Shared	SGX_EPC_PAGE _CONFLICT	
EMODPE	Target	[DS:RCX]	Concurrent		
	SECINFO	[DS:RBX]	Concurrent		
EMODPR	Target	[DS:RCX]	Shared	#GP	
EMODT	Target	[DS:RCX]	Exclusive	SGX_EPC_PAGE _CONFLICT	EPC_PAGE_CONFLICT_ERROR
EPA	VA	[DS:RCX]	Exclusive	#GP	EPC_PAGE_CONFLICT_EXCEPTION
ERDINFO	Target	[DS:RCX]	Shared	SGX_EPC_PAGE _CONFLICT	
EREMOVE	Target	[DS:RCX]	Exclusive	#GP	EPC_PAGE_CONFLICT_EXCEPTION

**Table 14-14. Base Concurrency Restrictions**

Leaf	Parameter		Base Concurrency Restrictions		
			Access	On Conflict	SGX_CONFLICT VM Exit Qualification
EREPORT	TARGETINFO	[DS:RBX]	Concurrent		
	REPORTDATA	[DS:RCX]	Concurrent		
	OUTPUTDATA	[DS:RDX]	Concurrent		
EREPORT2	REPORTDATA	[DS:RBX]	Concurrent		
	OUTPUTDATA	[DS:RCX]	Concurrent		
ERESUME	TCS	[DS:RBX]	Shared	#GP	
ESETCONTEXT	SECS	[DS:RCX]	Shared	SGX_EPC_PAGE_CONFLICT	
ETRACK	SECS	[DS:RCX]	Shared	#GP	
ETRACKC	Target	[DS:RCX]	Shared	SGX_EPC_PAGE_CONFLICT	
	SECS	Implicit	Concurrent		
EWB	Source	[DS:RCX]	Exclusive	#GP	EPC_PAGE_CONFLICT_EXCEPTION
	VA	[DS:RDX]	Shared	#GP	

**Table 14-15. Additional Concurrency Restrictions**

Leaf	Parameter		Additional Concurrency Restrictions					
			vs. EACCEPT, EACCEPTCOPY, EMODPE, EMODPR, EMODT		vs. EADD, EEXTEND, EINIT		vs. ETRACK, ETRACKC	
			Access	On Conflict	Access	On Conflict	Access	On Conflict
EACCEPT	Target	[DS:RCX]	Exclusive	#GP	Concurrent		Concurrent	
	SECINFO	[DS:RBX]	Concurrent		Concurrent		Concurrent	
EACCEPTCOPY	Target	[DS:RCX]	Exclusive	#GP	Concurrent		Concurrent	
	Source	[DS:RDX]	Concurrent		Concurrent		Concurrent	
	SECINFO	[DS:RBX]	Concurrent		Concurrent		Concurrent	
EADD	Target	[DS:RCX]	Concurrent		Concurrent		Concurrent	
	SECS	[DS:RBX]PAGEINFO. SECS	Concurrent		Exclusive	#GP	Concurrent	
EAUG	Target	[DS:RCX]	Concurrent		Concurrent		Concurrent	
	SECS	[DS:RBX]PAGEINFO. SECS	Concurrent		Concurrent		Concurrent	
EBLOCK	Target	[DS:RCX]	Concurrent		Concurrent		Concurrent	
ECREATE	SECS	[DS:RCX]	Concurrent		Concurrent		Concurrent	
EDBGD	Target	[DS:RCX]	Concurrent		Concurrent		Concurrent	
EDBGWR	Target	[DS:RCX]	Concurrent		Concurrent		Concurrent	
EDECVIRTUALCHILD	Target	[DS:RBX]	Concurrent		Concurrent		Concurrent	
	SECS	[DS:RCX]	Concurrent		Concurrent		Concurrent	
EENTERTCS	SECS	[DS:RBX]	Concurrent		Concurrent		Concurrent	

Table 14-15. Additional Concurrency Restrictions

Leaf	Parameter		Additional Concurrency Restrictions					
			vs. EACCEPT, EACCEPTCOPY, EMODPE, EMODPR, EMODT		vs. EADD, EEXTEND, EINIT		vs. ETRACK, ETRACKC	
			Access	On Conflict	Access	On Conflict	Access	On Conflict
EEXIT			Concurrent		Concurrent		Concurrent	
EEXTEND	Target	[DS:RCX]	Concurrent		Concurrent		Concurrent	
	SECS	[DS:RBX]	Concurrent		Exclusive	#GP	Concurrent	
EGETKEY/EGETKEY256	KEYREQUEST	[DS:RBX]	Concurrent		Concurrent		Concurrent	
	OUTPUTDATA	[DS:RCX]	Concurrent		Concurrent		Concurrent	
EINCVIRTCHILD	Target	[DS:RBX]	Concurrent		Concurrent		Concurrent	
	SECS	[DS:RCX]	Concurrent		Concurrent		Concurrent	
EINIT	SECS	[DS:RCX]	Concurrent		Exclusive	#GP	Concurrent	
ELDB/ELDU	Target	[DS:RCX]	Concurrent		Concurrent		Concurrent	
	VA	[DS:RDX]	Concurrent		Concurrent		Concurrent	
	SECS	[DS:RBX]PAGEINFO. SECS	Concurrent		Concurrent		Concurrent	
EDLBC/ELDUC	Target	[DS:RCX]	Concurrent		Concurrent		Concurrent	
	VA	[DS:RDX]	Concurrent		Concurrent		Concurrent	
	SECS	[DS:RBX]PAGEINFO. SECS	Concurrent		Concurrent		Concurrent	
EMODPE	Target	[DS:RCX]	Exclusive	#GP	Concurrent		Concurrent	
	SECINFO	[DS:RBX]	Concurrent		Concurrent		Concurrent	
EMODPR	Target	[DS:RCX]	Exclusive	SGX_EPC_PAGE_CONFLICT	Concurrent		Concurrent	
EMODT	Target	[DS:RCX]	Exclusive	SGX_EPC_PAGE_CONFLICT	Concurrent		Concurrent	
EPA	VA	[DS:RCX]	Concurrent		Concurrent		Concurrent	
ERDINFO	Target	[DS:RCX]	Concurrent		Concurrent		Concurrent	
EREMOVE	Target	[DS:RCX]	Concurrent		Concurrent		Concurrent	
EREPOR2	TARGETINFO	[DS:RBX]	Concurrent		Concurrent		Concurrent	
	REPORTDATA	[DS:RCX]	Concurrent		Concurrent		Concurrent	
	OUTPUTDATA	[DS:RDX]	Concurrent		Concurrent		Concurrent	
EREPOR2	REPORTDATA	[DS:RBX]	Concurrent		Concurrent		Concurrent	
	OUTPUTDATA	[DS:RCX]	Concurrent		Concurrent		Concurrent	
ERESUME	TCS	[DS:RBX]	Concurrent		Concurrent		Concurrent	
ESETCONTEXT	SECS	[DS:RCX]	Concurrent		Concurrent		Concurrent	
ETRACK	SECS	[DS:RCX]	Concurrent		Concurrent		Exclusive	SGX_EPC_PAGE_CONFLICT <sup>1</sup>

Table 14-15. Additional Concurrency Restrictions

Leaf	Parameter		Additional Concurrency Restrictions					
			vs. EACCEPT, EACCEPTCOPY, EMODPE, EMODPR, EMODT		vs. EADD, EEXTEND, EINIT		vs. ETRACK, ETRACKC	
			Access	On Conflict	Access	On Conflict	Access	On Conflict
ETRAKCC	Target	[DS:RCX]	Concurrent		Concurrent		Concurrent	
	SECS	Implicit	Concurrent		Concurrent		Exclusive	SGX_EPC_PAGE_CONFLICT <sup>1</sup>
EUPDATESVN	EPCM		Exclusive	SGX_EPC_PAGE_CONFLICT	Exclusive	SGX_EPC_PAGE_CONFLICT	Exclusive	SGX_EPC_PAGE_CONFLICT
EWB	Source	[DS:RCX]	Concurrent		Concurrent		Concurrent	
	VA	[DS:RDX]	Concurrent		Concurrent		Concurrent	

## NOTES:

1. SGX\_CONFLICT VM Exit Qualification =TRACKING\_RESOURCE\_CONFLICT.

## 14.7 INTEL® SGX SYSTEM LEAF FUNCTION REFERENCE

Leaf functions available with the ENCLS instruction mnemonic are covered in this section. In general, each instruction leaf requires EAX to specify the leaf function index and/or additional implicit registers specifying leaf-specific input parameters. An instruction operand encoding table provides details of each implicit register usage and associated input/output semantics.

In many cases, an input parameter specifies an effective address associated with a memory object inside or outside the EPC, the memory addressing semantics of these memory objects are also summarized in a separate table.

## EADD—Add a Page to an Uninitialized Enclave

Opcode/ Instruction	Op/En	64/32 bit Mode Support	CPUID Feature Flag	Description
EAX = 01H ENCLS[EADD]	IR	V/V	SGX1	This leaf function adds a page to an uninitialized enclave.

### Instruction Operand Encoding

Op/En	EAX	RBX	RCX
IR	EADD (In)	Address of a PAGEINFO (In)	Address of the destination EPC page (In)

### Description

This leaf function copies a source page from non-enclave memory into the EPC, associates the EPC page with an SECS page residing in the EPC, and stores the linear address and security attributes in EPCM. As part of the association, the enclave offset and the security attributes are measured and extended into the SECS.MRENCLAVE. This instruction can only be executed when current privilege level is 0.

RBX contains the effective address of a PAGEINFO structure while RCX contains the effective address of an EPC page. The table below provides additional information on the memory parameter of EADD leaf function.

### EADD Memory Parameter Semantics

PAGEINFO	PAGEINFO.SECS	PAGEINFO.SRCPGE	PAGEINFO.SECINFO	EPCPAGE
Read access permitted by Non Enclave	Read/Write access permitted by Enclave	Read access permitted by Non Enclave	Read access permitted by Non Enclave	Write access permitted by Enclave

The instruction faults if any of the following:

### EADD Faulting Conditions

The operands are not properly aligned.	Unsupported security attributes are set.
Refers to an invalid SECS.	Reference is made to an SECS that is locked by another thread.
The EPC page is locked by another thread.	RCX does not contain an effective address of an EPC page.
The EPC page is already valid.	If security attributes specifies a TCS and the source page specifies unsupported TCS values or fields.
The SECS has been initialized.	The specified enclave offset is outside of the enclave address space.

### Concurrency Restrictions

**Table 14-16. Base Concurrency Restrictions of EADD**

Leaf	Parameter	Base Concurrency Restrictions		
		Access	On Conflict	SGX_CONFLICT VM Exit Qualification
EADD	Target [DS:RCX]	Exclusive	#GP	EPC_PAGE_CONFLICT_EXCEPTION
	SECS [DS:RBX]PAGEINFO.SECS	Shared	#GP	



Table 14-17. Additional Concurrency Restrictions of EADD

Leaf	Parameter	Additional Concurrency Restrictions					
		vs. EACCEPT, EACCEPTCOPY, EMODPE, EMODPR, EMODT		vs. EADD, EEXTEND, EINIT		vs. ETRACK, ETRACKC	
		Access	On Conflict	Access	On Conflict	Access	On Conflict
EADD	Target [DS:RCX]	Concurrent		Concurrent		Concurrent	
	SECS [DS:RBX]PAGE-INFO.SECS	Concurrent		Exclusive	#GP	Concurrent	

## Operation

### Temp Variables in EADD Operational Flow

Name	Type	Size (bits)	Description
TMP_SRCPGE	Effective Address	32/64	Effective address of the source page.
TMP_SECS	Effective Address	32/64	Effective address of the SECS destination page.
TMP_SECINFO	Effective Address	32/64	Effective address of an SECINFO structure which contains security attributes of the page to be added.
SCRATCH_SECINFO	SECINFO	512	Scratch storage for holding the contents of DS:TMP_SECINFO.
TMP_LINADDR	Unsigned Integer	64	Holds the linear address to be stored in the EPCM and used to calculate TMP_ENCLAVEOFFSET.
TMP_ENCLAVEOFFSET	Enclave Offset	64	The page displacement from the enclave base address.
TMPUPDATEFIELD	SHA Buffer	1024	Buffer used to hold data being added to TMP_SECS.MRENCLAVE.

IF (DS:RBX is not 32Byte Aligned)  
THEN #GP(0); FI;

IF (DS:RCX is not 4KByte Aligned)  
THEN #GP(0); FI;

IF (DS:RCX does not resolve within an EPC)  
THEN #PF(DS:RCX); FI;

TMP\_SRCPGE := DS:RBX.SRCPGE;  
TMP\_SECS := DS:RBX.SECS;  
TMP\_SECINFO := DS:RBX.SECINFO;  
TMP\_LINADDR := DS:RBX.LINADDR;

IF (DS:TMP\_SRCPGE is not 4KByte aligned or DS:TMP\_SECS is not 4KByte aligned or  
DS:TMP\_SECINFO is not 64Byte aligned or TMP\_LINADDR is not 4KByte aligned)  
THEN #GP(0); FI;

IF (DS:TMP\_SECS does not resolve within an EPC)  
THEN #PF(DS:TMP\_SECS); FI;

SCRATCH\_SECINFO := DS:TMP\_SECINFO;

(\* Check for misconfigured SECINFO flags\*)  
IF (SCRATCH\_SECINFO reserved fields are not zero or

```
! (SCRATCH_SECINFO.FLAGS.PT is PT_REG or SCRATCH_SECINFO.FLAGS.PT is PT_TCS or
(SCRATCH_SECINFO.FLAGS.PT is PT_SS_FIRST and CPUID.(EAX=12H, ECX=1):EAX[6] = 1) or
(SCRATCH_SECINFO.FLAGS.PT is PT_SS_REST and CPUID.(EAX=12H, ECX=1):EAX[6] = 1))
THEN #GP(0); FI;
```

```
(* If PT_SS_FIRST/PT_SS_REST page types are requested then CR4.CET must be 1 *)
IF ( (SCRATCH_SECINFO.FLAGS.PT is PT_SS_FIRST OR
SCRATCH_SECINFO.FLAGS.PT is PT_SS_REST) AND CR4.CET == 0)
THEN #GP(0); FI;
```

```
(* Check the EPC page for concurrency *)
IF (EPC page is not available for EADD)
THEN
  IF (<<VMX non-root operation>> AND <<ENABLE_EPC_VIRTUALIZATION_EXTENSIONS>>)
  THEN
    VMCS.Exit_reason := SGX_CONFLICT;
    VMCS.Exit_qualification.code := EPC_PAGE_CONFLICT_EXCEPTION;
    VMCS.Exit_qualification.error := 0;
    VMCS.Guest-physical_address := << translation of DS:RCX produced by paging >>;
    VMCS.Guest-linear_address := DS:RCX;
    Deliver VMEXIT;
  ELSE
    #GP(0);
  FI;
FI;
```

```
IF (EPCM(DS:RCX).VALID ≠ 0)
THEN #PF(DS:RCX); FI;
```

```
(* Check the SECS for concurrency *)
IF (SECS is not available for EADD)
THEN #GP(0); FI;
```

```
IF (EPCM(DS:TMP_SECS).VALID = 0 or EPCM(DS:TMP_SECS).PT ≠ PT_SECS)
THEN #PF(DS:TMP_SECS); FI;
```

```
(* Copy 4KBytes from source page to EPC page*)
DS:RCX[32767:0] := DS:TMP_SRCPAGE[32767:0];
```

```
CASE (SCRATCH_SECINFO.FLAGS.PT)
```

```
PT_TCS:
  IF (DS:RCX.RESERVED ≠ 0) #GP(0); FI;
  IF ( (DS:TMP_SECS.ATTRIBUTES.MODE64BIT = 0) and
((DS:TCS.FSLIMIT & 0FFFH ≠ 0FFFH) or (DS:TCS.GSLIMIT & 0FFFH ≠ 0FFFH)) ) #GP(0); FI;
  (* Ensure TCS.PREVSSP is zero *)
  IF (CPUID.(EAX=07H, ECX=00h):ECX[CET_SS] = 1) and (DS:RCX.PREVSSP ≠ 0) #GP(0); FI;
  BREAK;
```

```
PT_REG:
  IF (SCRATCH_SECINFO.FLAGS.W = 1 and SCRATCH_SECINFO.FLAGS.R = 0) #GP(0); FI;
  BREAK;
```

```
PT_SS_FIRST:
```

```
PT_SS_REST:
```

```
(* SS pages cannot be created on first or last page of ELRANGE *)
```

```

IF ( TMP_LINADDR = DS:TMP_SECS.BASEADDR or TMP_LINADDR = (DS:TMP_SECS.BASEADDR + DS:TMP_SECS.SIZE - 0x1000) )
  THEN #GP(0); FI;
IF ( DS:RCX[4087:0] != 0 ) #GP(0); FI;
IF (SCRATCH_SECINFO.FLAGS.PT == PT_SS_FIRST)
  THEN
    (* Check that valid RSTORSSP token exists *)
    IF ( DS:RCX[4095:4088] != ((TMP_LINADDR + 0x1000) | DS:TMP_SECS.ATTRIBUTES.MODE64BIT) ) #GP(0); FI;
  ELSE
    (* Check the 8 bytes are zero *)
    IF ( DS:RCX[4095:4088] != 0 ) #GP(0); FI;
  FI;
IF (SCRATCH_SECINFO.FLAGS.W = 0 OR SCRATCH_SECINFO.FLAGS.R = 0 OR
  SCRATCH_SECINFO.FLAGS.X = 1) #GP(0); FI;
  BREAK;
ESAC;

```

(\* Check the enclave offset is within the enclave linear address space \*)

```

IF (TMP_LINADDR < DS:TMP_SECS.BASEADDR or TMP_LINADDR ≥ DS:TMP_SECS.BASEADDR + DS:TMP_SECS.SIZE)
  THEN #GP(0); FI;

```

(\* Check concurrency of measurement resource\*)

```

IF (Measurement being updated)
  THEN #GP(0); FI;

```

(\* Check if the enclave to which the page will be added is already in Initialized state \*)

```

IF (DS:TMP_SECS already initialized)
  THEN #GP(0); FI;

```

(\* For TCS pages, force EPCM.rwx bits to 0 and no debug access \*)

```

IF (SCRATCH_SECINFO.FLAGS.PT = PT_TCS)
  THEN
    SCRATCH_SECINFO.FLAGS.R := 0;
    SCRATCH_SECINFO.FLAGS.W := 0;
    SCRATCH_SECINFO.FLAGS.X := 0;
    (DS:RCX).FLAGS.DBGOPTIN := 0; // force TCS.FLAGS.DBGOPTIN off
    DS:RCX.CSSA := 0;
    DS:RCX.AEP := 0;
    DS:RCX.STATE := 0;
  FI;

```

(\* Add enclave offset and security attributes to MRENCLAVE \*)

```

TMP_ENCLAVEOFFSET := TMP_LINADDR - DS:TMP_SECS.BASEADDR;
TMPUPDATEFIELD[63:0] := 0000000044444145H; // "EADD"
TMPUPDATEFIELD[127:64] := TMP_ENCLAVEOFFSET;
TMPUPDATEFIELD[511:128] := SCRATCH_SECINFO[375:0]; // 48 bytes
TMPUPDATEFIELD[1023:512] := 0x00; // 64 bytes
IF (DS:TMP_SECS.ATTRIBUTES.SHA384 == 0)
  THEN
    DS:TMP_SECS.MRENCLAVE := SHA256UPDATE(DS:TMP_SECS.MRENCLAVE, TMPUPDATEFIELD[511:0])
  ELSE
    DS:TMP_SECS.MRENCLAVE384 := SHA384UPDATE(DS:TMP_SECS.MRENCLAVE384, TMPUPDATEFIELD[1023:0]);
  FI;

```

INC enclave's MRENCLAVE update counter;

(\* Add enclave offset and security attributes to MRENCLAVE \*)

```
EPCM(DS:RCX).R := SCRATCH_SECINFO.FLAGS.R;
EPCM(DS:RCX).W := SCRATCH_SECINFO.FLAGS.W;
EPCM(DS:RCX).X := SCRATCH_SECINFO.FLAGS.X;
EPCM(DS:RCX).PT := SCRATCH_SECINFO.FLAGS.PT;
EPCM(DS:RCX).ENCLAVEADDRESS := TMP_LINADDR;
```

(\* associate the EPCPAGE with the SECS by storing the SECS identifier of DS:TMP\_SECS \*)

Update EPCM(DS:RCX) SECS identifier to reference DS:TMP\_SECS identifier;

(\* Set EPCM entry fields \*)

```
EPCM(DS:RCX).BLOCKED := 0;
EPCM(DS:RCX).PENDING := 0;
EPCM(DS:RCX).MODIFIED := 0;
EPCM(DS:RCX).VALID := 1;
```

### Flags Affected

None

### Protected Mode Exceptions

#GP(0)	<ul style="list-style-type: none"> <li>If a memory operand effective address is outside the DS segment limit.</li> <li>If a memory operand is not properly aligned.</li> <li>If an enclave memory operand is outside of the EPC.</li> <li>If an enclave memory operand is the wrong type.</li> <li>If a memory operand is locked.</li> <li>If the enclave is initialized.</li> <li>If the enclave's MRENCLAVE is locked.</li> <li>If the TCS page reserved bits are set.</li> <li>If the TCS page PREVSSP field is not zero.</li> <li>If the PT_SS_REST or PT_SS_REST page is the first or last page in the enclave.</li> <li>If the PT_SS_FIRST or PT_SS_REST page is not initialized correctly.</li> </ul>
#PF(error code)	<ul style="list-style-type: none"> <li>If a page fault occurs in accessing memory operands.</li> <li>If the EPC page is valid.</li> </ul>

### 64-Bit Mode Exceptions

#GP(0)	<ul style="list-style-type: none"> <li>If a memory operand is non-canonical form.</li> <li>If a memory operand is not properly aligned.</li> <li>If an enclave memory operand is outside of the EPC.</li> <li>If an enclave memory operand is the wrong type.</li> <li>If a memory operand is locked.</li> <li>If the enclave is initialized.</li> <li>If the enclave's MRENCLAVE is locked.</li> <li>If the TCS page reserved bits are set.</li> <li>If the TCS page PREVSSP field is not zero.</li> <li>If the PT_SS_REST or PT_SS_REST page is the first or last page in the enclave.</li> <li>If the PT_SS_FIRST or PT_SS_REST page is not initialized correctly.</li> </ul>
#PF(error code)	<ul style="list-style-type: none"> <li>If a page fault occurs in accessing memory operands.</li> <li>If the EPC page is valid.</li> </ul>

## ECREATE—Create an SECS page in the Enclave Page Cache

Opcode/ Instruction	Op/En	64/32 bit Mode Support	CPUID Feature Flag	Description
EAX = 00H ENCLS[ECREATE]	IR	V/V	SGX1	This leaf function begins an enclave build by creating an SECS page in EPC.

### Instruction Operand Encoding

Op/En	EAX	RBX	RCX
IR	ECREATE (In)	Address of a PAGEINFO (In)	Address of the destination SECS page (In)

#### Description

ENCLS[ECREATE] is the first instruction executed in the enclave build process. ECREATE copies an SECS structure outside the EPC into an SECS page inside the EPC. The internal structure of SECS is not accessible to software.

ECREATE will set up fields in the protected SECS and mark the page as valid inside the EPC. ECREATE initializes or checks unused fields.

Software sets the following fields in the source structure: SECS:BASEADDR, SECS:SIZE in bytes, ATTRIBUTES, CONFIGID, and CONFIGSVN. SECS:BASEADDR must be naturally aligned on an SECS.SIZE boundary. SECS.SIZE must be at least 2 pages (8192).

The source operand RBX contains an effective address of a PAGEINFO structure. PAGEINFO contains an effective address of a source SECS and an effective address of an SECINFO. The SECS field in PAGEINFO is not used.

The RCX register is the effective address of the destination SECS. It is an address of an empty slot in the EPC. The SECS structure must be page aligned. SECINFO flags must specify the page as an SECS page.

### ECREATE Memory Parameter Semantics

PAGEINFO	PAGEINFO.SRCPGE	PAGEINFO.SECINFO	EPCPAGE
Read access permitted by Non Enclave	Read access permitted by Non Enclave	Read access permitted by Non Enclave	Write access permitted by Enclave

ECREATE will fault if the SECS target page is in use; already valid; outside the EPC. It will also fault if addresses are not aligned; unused PAGEINFO fields are not zero.

If the amount of space needed to store the SSA frame is greater than the amount specified in SECS.SSAFRAME-SIZE, a #GP(0) results. The amount of space needed for an SSA frame is computed based on DS:TMP\_-SECS.ATTRIBUTES.XFRM size. Details of computing the size can be found Section 40.7.

#### Concurrency Restrictions

**Table 14-18. Base Concurrency Restrictions of ECREATE**

Leaf	Parameter	Base Concurrency Restrictions		
		Access	On Conflict	SGX_CONFLICT VM Exit Qualification
ECREATE	SECS [DS:RCX]	Exclusive	#GP	EPC_PAGE_CONFLICT_EXCEPTION

**Table 14-19. Additional Concurrency Restrictions of ECREATE**

Leaf	Parameter	Additional Concurrency Restrictions					
		vs. EACCEPT, EACCEPTCOPY, EMODPE, EMODPR, EMODT		vs. EADD, EEXTEND, EINIT		vs. ETRACK, ETRACKC	
		Access	On Conflict	Access	On Conflict	Access	On Conflict
ECREATE	SECS [DS:RCX]	Concurrent		Concurrent		Concurrent	

**Operation**
**Temp Variables in ECREATE Operational Flow**

Name	Type	Size (Bits)	Description
TMP_SRCPGE	Effective Address	32/64	Effective address of the SECS source page.
TMP_SECS	Effective Address	32/64	Effective address of the SECS destination page.
TMP_SECINFO	Effective Address	32/64	Effective address of an SECINFO structure which contains security attributes of the SECS page to be added.
TMP_XSIZE	SSA Size	64	The size calculation of SSA frame.
TMP_MISC_SIZE	MISC Field Size	64	Size of the selected MISC field components.
TMPUPDATEFIELD	SHA Buffer	1023	Buffer used to hold data being added to TMP_SECS.MRENCLAVE.

```
IF (DS:RBX is not 32Byte Aligned)
    THEN #GP(0); FI;
```

```
IF (DS:RCX is not 4KByte Aligned)
    THEN #GP(0); FI;
```

```
IF (DS:RCX does not resolve within an EPC)
    THEN #PF(DS:RCX); FI;
```

```
TMP_SRCPGE := DS:RBX.SRCPGE;
TMP_SECINFO := DS:RBX.SECINFO;
```

```
IF (DS:TMP_SRCPGE is not 4KByte aligned or DS:TMP_SECINFO is not 64Byte aligned)
    THEN #GP(0); FI;
```

```
IF (DS:RBX.LINADDR != 0 or DS:RBX.SECS != 0)
    THEN #GP(0); FI;
```

(\* Check for misconfigured SECINFO flags\*)

```
IF (DS:TMP_SECINFO reserved fields are not zero or DS:TMP_SECINFO.FLAGS.PT != PT_SECS)
    THEN #GP(0); FI;
```

```
TMP_SECS := RCX;
```

```
IF (EPC entry in use)
    THEN
```

```
    IF (<<VMX non-root operation>> AND <<ENABLE_EPC_VIRTUALIZATION_EXTENSIONS>>)
```

```
        THEN
```

```
            VMCS.Exit_reason := SGX_CONFLICT;
```

```

        VMCS.Exit_qualification.code := EPC_PAGE_CONFLICT_EXCEPTION;
        VMCS.Exit_qualification.error := 0;
        VMCS.Guest-physical_address :=
            << translation of DS:TMP_SECS produced by paging >>;
        VMCS.Guest-linear_address := DS:TMP_SECS;
    Deliver VMEXIT;
    ELSE
        #GP(0);
FI;

FI;

IF (EPC entry in use)
    THEN #GP(0); FI;

IF (EPCM(DS:RCX).VALID = 1)
    THEN #PF(DS:RCX); FI;

(* Copy 4KBytes from source page to EPC page*)
DS:RCX[32767:0] := DS:TMP_SRCPGE[32767:0];

(* Check lower 2 bits of XFRM are set *)
IF ( ( DS:TMP_SECS.ATTRIBUTES.XFRM BitwiseAND 03H) ≠ 03H)
    THEN #GP(0); FI;

IF (XFRM is illegal)
    THEN #GP(0); FI;

(* Check legality of CET_ATTRIBUTES *)
IF ((DS:TMP_SECS.ATTRIBUTES.CET = 0 and DS:TMP_SECS.CET_ATTRIBUTES ≠ 0) ||
    (DS:TMP_SECS.ATTRIBUTES.CET = 0 and DS:TMP_SECS.CET_LEG_BITMAP_OFFSET ≠ 0) ||
    (CPUID.(EAX=7, ECX=0):EDX[CET_IBT] = 0 and DS:TMP_SECS.CET_LEG_BITMAP_OFFSET ≠ 0) ||
    (CPUID.(EAX=7, ECX=0):EDX[CET_IBT] = 0 and DS:TMP_SECS.CET_ATTRIBUTES[5:2] ≠ 0) ||
    (CPUID.(EAX=7, ECX=0):ECX[CET_SS] = 0 and DS:TMP_SECS.CET_ATTRIBUTES[1:0] ≠ 0) ||
    (DS:TMP_SECS.ATTRIBUTES.MODE64BIT = 1 and
    (DS:TMP_SECS.BASEADDR + DS:TMP_SECS.CET_LEG_BITMAP_OFFSET) not canonical) ||
    (DS:TMP_SECS.ATTRIBUTES.MODE64BIT = 0 and
    (DS:TMP_SECS.BASEADDR + DS:TMP_SECS.CET_LEG_BITMAP_OFFSET) & 0xFFFFFFFF00000000) ||
    (DS:TMP_SECS.CET_ATTRIBUTES.reserved fields not 0) or
    (DS:TMP_SECS.CET_LEG_BITMAP_OFFSET) is not page aligned))
    THEN
        #GP(0);
FI;

(* Make sure that the SECS does not have any unsupported MISCSELECT options*)
IF ( !(CPUID.(EAX=12H, ECX=0):EBX[31:0] & DS:TMP_SECS.MISCSELECT[31:0]) )
    THEN
        EPCM(DS:TMP_SECS).EntryLock.Release();
        #GP(0);
FI;

(* Compute size of MISC area *)
TMP_MISC_SIZE := compute_misc_region_size();

(* Compute the size required to save state of the enclave on async exit, see Section 40.7.2.2*)

```

```
TMP_XSIZE := compute_xsave_size(DS:TMP_SECS.ATTRIBUTES.XFRM) + GPR_SIZE + TMP_MISC_SIZE;
```

```
(* Ensure that the declared area is large enough to hold XSAVE and GPR stat *)
```

```
IF ( DS:TMP_SECS.SSAFRAMESIZE*4096 < TMP_XSIZE)
```

```
    THEN #GP(0); FI;
```

```
IF ( ( DS:TMP_SECS.ATTRIBUTES.MODE64BIT = 1) and (DS:TMP_SECS.BASEADDR is not canonical) )
```

```
    THEN #GP(0); FI;
```

```
IF ( ( DS:TMP_SECS.ATTRIBUTES.MODE64BIT = 0) and (DS:TMP_SECS.BASEADDR and 0FFFFFFF00000000H) )
```

```
    THEN #GP(0); FI;
```

```
IF ( ( DS:TMP_SECS.ATTRIBUTES.MODE64BIT = 0) and (DS:TMP_SECS.SIZE ≥ 2 ^ (CPUID.(EAX=12H, ECX=0):.EDX[7:0]) ) )
```

```
    THEN #GP(0); FI;
```

```
IF ( ( DS:TMP_SECS.ATTRIBUTES.MODE64BIT = 1) and (DS:TMP_SECS.SIZE ≥ 2 ^ (CPUID.(EAX=12H, ECX=0):.EDX[15:8]) ) )
```

```
    THEN #GP(0); FI;
```

```
(* Enclave size must be at least 8192 bytes and must be power of 2 in bytes*)
```

```
IF (DS:TMP_SECS.SIZE < 8192 or popcnt(DS:TMP_SECS.SIZE) > 1)
```

```
    THEN #GP(0); FI;
```

```
(* Ensure base address of an enclave is aligned on size*)
```

```
IF ( ( DS:TMP_SECS.BASEADDR and (DS:TMP_SECS.SIZE-1) ) )
```

```
    THEN #GP(0); FI;
```

```
(* Ensure the SECS does not have any unsupported attributes*)
```

```
IF ( DS:TMP_SECS.ATTRIBUTES and (~CR_SGX_ATTRIBUTES_MASK) )
```

```
    THEN #GP(0); FI;
```

```
IF ( DS:TMP_SECS reserved fields are not zero)
```

```
    THEN #GP(0); FI;
```

```
(* Verify that CONFIGID/CONFIGSVN are not set with attribute *)
```

```
IF ( ((DS:TMP_SECS.CONFIGID ≠ 0) or (DS:TMP_SECS.CONFIGSVN ≠ 0)) AND (DS:TMP_SECS.ATTRIBUTES.KSS == 0) )
```

```
    THEN #GP(0); FI;
```

```
Clear DS:TMP_SECS to Uninitialized;
```

```
DS:TMP_SECS.MRENCLAVE := SHA256INITIALIZE(DS:TMP_SECS.MRENCLAVE);
```

```
DS:TMP_SECS.MRSIGNER := 0;
```

```
DS:TMP_SECS.MRSIGNER384 := 0;
```

```
DS:TMP_SECS.ISVSVN := 0;
```

```
DS:TMP_SECS.ISVPRODID := 0;
```

```
(* Initialize hash updates etc*)
```

```
Initialize enclave's MRENCLAVE update counter;
```

```
(* Add "ECREATE" string and SECS fields to MRENCLAVE *)
```

```
TMPUPDATEFIELD[63:0] := 0045544145524345H; // "ECREATE"
```

```
TMPUPDATEFIELD[95:64] := DS:TMP_SECS.SSAFRAMESIZE;
```

```
TMPUPDATEFIELD[159:96] := DS:TMP_SECS.SIZE;
```

```
IF (CPUID.(EAX=7, ECX=0):.EDX[CET_IBT] = 1)
```

```
    THEN
```

```
        TMPUPDATEFIELD[223:160] := DS:TMP_SECS.CET_LEG_BITMAP_OFFSET;
```



```

ELSE
    TMPUPDATEFIELD[223:160] := 0;
FI;
TMPUPDATEFIELD[1023:160] := 0;

IF (DS:TMP_SECS.ATTRIBUTES.SHA384 == 0)
    THEN
        DS:TMP_SECS.MRENCLAVE := SHA256UPDATE(DS:TMP_SECS.MRENCLAVE, TMPUPDATEFIELD[511:0])
    ELSE
        DS:TMP_SECS.MRENCLAVE384 := SHA384UPDATE(DS:TMP_SECS.MRENCLAVE384, TMPUPDATEFIELD[1023:0])
FI;

INC enclave's MRENCLAVE update counter;

(* Set EID *)
DS:TMP_SECS.EID := LockedXAdd(CR_NEXT_EID, 1);

(* Initialize the virtual child count to zero *)
DS:TMP_SECS.VIRTCHILDCNT := 0;

(* Load ENCLAVECONTEXT with Address out of paging of SECS *)
<< store translation of DS:RCX produced by paging in SECS(DS:RCX).ENCLAVECONTEXT >>

(* Set the EPCM entry, first create SECS identifier and store the identifier in EPCM *)
EPCM(DS:TMP_SECS).PT := PT_SECS;
EPCM(DS:TMP_SECS).ENCLAVEADDRESS := 0;
EPCM(DS:TMP_SECS).R := 0;
EPCM(DS:TMP_SECS).W := 0;
EPCM(DS:TMP_SECS).X := 0;

(* Set EPCM entry fields *)
EPCM(DS:RCX).BLOCKED := 0;
EPCM(DS:RCX).PENDING := 0;
EPCM(DS:RCX).MODIFIED := 0;
EPCM(DS:RCX).PR := 0;
EPCM(DS:RCX).VALID := 1;

```

**Flags Affected**

None

**Protected Mode Exceptions**

#GP(0)	<ul style="list-style-type: none"> <li>If a memory operand effective address is outside the DS segment limit.</li> <li>If a memory operand is not properly aligned.</li> <li>If the reserved fields are not zero.</li> <li>If PAGEINFO.SECS is not zero.</li> <li>If PAGEINFO.LINADDR is not zero.</li> <li>If the SECS destination is locked.</li> <li>If SECS.SSAFRAMESIZE is insufficient.</li> </ul>
#PF(error code)	<ul style="list-style-type: none"> <li>If a page fault occurs in accessing memory operands.</li> <li>If the SECS destination is outside the EPC.</li> </ul>

## 64-Bit Mode Exceptions

#GP(0)	<ul style="list-style-type: none"><li>If a memory address is non-canonical form.</li><li>If a memory operand is not properly aligned.</li><li>If the reserved fields are not zero.</li><li>If PAGEINFO.SECS is not zero.</li><li>If PAGEINFO.LINADDR is not zero.</li><li>If the SECS destination is locked.</li><li>If SECS.SSAFRAMESIZE is insufficient.</li></ul>
#PF(error code)	<ul style="list-style-type: none"><li>If a page fault occurs in accessing memory operands.</li><li>If the SECS destination is outside the EPC.</li></ul>

**EEXTEND—Extend Uninitialized Enclave Measurement by 256 Bytes**

Opcode/ Instruction	Op/En	64/32 bit Mode Support	CPUID Feature Flag	Description
EAX = 06H ENCLS[EEXTEND]	IR	V/V	SGX1	This leaf function measures 256 bytes of an uninitialized enclave page.

**Instruction Operand Encoding**

Op/En	EAX	EBX	RCX
IR	EEXTEND (In)	Effective address of the SECS of the data chunk (In)	Effective address of a 256-byte chunk in the EPC (In)

**Description**

This leaf function updates the MRENCLAVE measurement register of an SECS with the measurement of an EXTEND string comprising of “EEXTEND” || ENCLAVEOFFSET || PADDING || 256 bytes of the enclave page. This instruction can only be executed when current privilege level is 0 and the enclave is uninitialized.

RBX contains the effective address of the SECS of the region to be measured. The address must be the same as the one used to add the page into the enclave.

RCX contains the effective address of the 256 byte region of an EPC page to be measured. The DS segment is used to create linear addresses. Segment override is not supported.

**EEXTEND Memory Parameter Semantics**

EPC[RCX]
Read access by Enclave

The instruction faults if any of the following:

**EEXTEND Faulting Conditions**

RBX points to an address not 4KBytes aligned.	RBX does not resolve to an SECS.
RBX does not point to an SECS page.	RBX does not point to the SECS page of the data chunk.
RCX points to an address not 256B aligned.	RCX points to an unused page or a SECS.
RCX does not resolve in an EPC page.	If SECS is locked.
If the SECS is already initialized.	May page fault.
CPL > 0.	

**Concurrency Restrictions****Table 14-20. Base Concurrency Restrictions of EEXTEND**

Leaf	Parameter	Base Concurrency Restrictions		
		Access	On Conflict	SGX_CONFLICT VM Exit Qualification
EEXTEND	Target [DS:RCX]	Shared	#GP	
	SECS [DS:RBX]	Concurrent		

**Table 14-21. Additional Concurrency Restrictions of EEXTEND**

Leaf	Parameter	Additional Concurrency Restrictions					
		vs. EACCEPT, EACCEPTCOPY, EMODPE, EMODPR, EMODT		vs. EADD, EEXTEND, EINIT		vs. ETRACK, ETRACKC	
		Access	On Conflict	Access	On Conflict	Access	On Conflict
EEXTEND	Target [DS:RCX]	Concurrent		Concurrent		Concurrent	
	SECS [DS:RBX]	Concurrent		Exclusive	#GP	Concurrent	

## Operation

### Temp Variables in EEXTEND Operational Flow

Name	Type	Size (Bits)	Description
TMP_SECS		64	Physical address of SECS of the enclave to which source operand belongs.
TMP_ENCLAVEOFFS ET	Enclave Offset	64	The page displacement from the enclave base address.
TMPUPDATEFIELD	SHA Buffer	1023	Buffer used to hold data being added to TMP_SECS.MRENCLAVE.

```
TMP_MODE64 := ((IA32_EFER.LMA = 1) && (CS.L = 1));
```

```
IF (DS:RBX is not 4096 Byte Aligned)
    THEN #GP(0); FI;
```

```
IF (DS:RBX does not resolve to an EPC page)
    THEN #PF(DS:RBX); FI;
```

```
IF (DS:RCX is not 256Byte Aligned)
    THEN #GP(0); FI;
```

```
IF (DS:RCX does not resolve within an EPC)
    THEN #PF(DS:RCX); FI;
```

```
(* make sure no other Intel SGX instruction is accessing EPCM *)
IF (Other instructions accessing EPCM)
    THEN #GP(0); FI;
```

```
IF (EPCM(DS:RCX).VALID = 0)
    THEN #PF(DS:RCX); FI;
```

```
(* make sure that DS:RCX (DST) is pointing to a PT_REG or PT_TCS or PT_SS_FIRST or PT_SS_REST *)
IF ( (EPCM(DS:RCX).PT ≠ PT_REG) and (EPCM(DS:RCX).PT ≠ PT_TCS)
    and (EPCM(DS:RCX).PT ≠ PT_SS_FIRST) and (EPCM(DS:RCX).PT ≠ PT_SS_REST))
    THEN #PF(DS:RCX); FI;
```

```
TMP_SECS := Get_SECS_ADDRESS();
```

```
IF (DS:RBX does not resolve to TMP_SECS)
    THEN #GP(0); FI;
```

```
(* make sure no other instruction is accessing MRENCLAVE or ATTRIBUTES.INIT *)
IF ( (Other instruction accessing MRENCLAVE) or (Other instructions checking or updating the initialized state of the SECS))
```

```
THEN #GP(0); FI;
```

```
(* Calculate enclave offset *)
```

```
TMP_ENCLAVEOFFSET := EPCM(DS:RCX).ENCLAVEADDRESS - TMP_SECS.BASEADDR;
```

```
TMP_ENCLAVEOFFSET := TMP_ENCLAVEOFFSET + (DS:RCX & 0FFFH)
```

```
(* Add EEXTEND message and offset to MRENCLAVE *)
```

```
TMPUPDATEFIELD[63:0] := 00444E4554584545H; // "EEXTEND"
```

```
TMPUPDATEFIELD[127:64] := TMP_ENCLAVEOFFSET;
```

```
TMPUPDATEFIELD[1023:128] := 0; // 112 bytes
```

```
IF (TMP_SECS.ATTRIBUTES.SHA384 = 0)
```

```
THEN
```

```
    TMP_SECS.MRENCLAVE := SHA256UPDATE(TMP_SECS.MRENCLAVE, TMPUPDATEFIELD[511:0])
```

```
    INC enclave's MRENCLAVE update counter;
```

```
    (*Add 256 bytes to MRENCLAVE, 64 byte at a time *)
```

```
    TMP_SECS.MRENCLAVE := SHA256UPDATE(TMP_SECS.MRENCLAVE, DS:RCX[511:0]);
```

```
    TMP_SECS.MRENCLAVE := SHA256UPDATE(TMP_SECS.MRENCLAVE, DS:RCX[1023: 512]);
```

```
    TMP_SECS.MRENCLAVE := SHA256UPDATE(TMP_SECS.MRENCLAVE, DS:RCX[1535: 1024]);
```

```
    TMP_SECS.MRENCLAVE := SHA256UPDATE(TMP_SECS.MRENCLAVE, DS:RCX[2047: 1536]);
```

```
    INC enclave's MRENCLAVE update counter by 4;
```

```
ELSE
```

```
    TMP_SECS.MRENCLAVE384 := SHA256UPDATE(TMP_SECS.MRENCLAVE, TMPUPDATEFIELD[511:0])
```

```
    INC enclave's MRENCLAVE update counter;
```

```
    (*Add 256 bytes to MRENCLAVE, 128 byte at a time *)
```

```
    TMP_SECS.MRENCLAVE384 := SHA384UPDATE(TMP_SECS.MRENCLAVE384, DS:RCX[1023:0]);
```

```
    TMP_SECS.MRENCLAVE384 := SHA384UPDATE(TMP_SECS.MRENCLAVE384, DS:RCX[2047: 1024]);
```

```
    INC enclave's MRENCLAVE update counter by 4;
```

```
FI
```

### Flags Affected

None

### Protected Mode Exceptions

#GP(0)	<ul style="list-style-type: none"> <li>If the address in RBX is outside the DS segment limit.</li> <li>If RBX points to an SECS page which is not the SECS of the data chunk.</li> <li>If the address in RCX is outside the DS segment limit.</li> <li>If RCX points to a memory location not 256Byte-aligned.</li> <li>If another instruction is accessing MRENCLAVE.</li> <li>If another instruction is checking or updating the SECS.</li> <li>If the enclave is already initialized.</li> </ul>
#PF(error code)	<ul style="list-style-type: none"> <li>If a page fault occurs in accessing memory operands.</li> <li>If the address in RBX points to a non-EPC page.</li> <li>If the address in RCX points to a page which is not PT_TCS or PT_REG.</li> <li>If the address in RCX points to a non-EPC page.</li> <li>If the address in RCX points to an invalid EPC page.</li> </ul>

### 64-Bit Mode Exceptions

#GP(0) If RBX is non-canonical form.

#PF(error code)

- If RBX points to an SECS page which is not the SECS of the data chunk.
- If RCX is non-canonical form.
- If RCX points to a memory location not 256 Byte-aligned.
- If another instruction is accessing MRENCLAVE.
- If another instruction is checking or updating the SECS.
- If the enclave is already initialized.
- If a page fault occurs in accessing memory operands.
- If the address in RBX points to a non-EPC page.
- If the address in RCX points to a page which is not PT\_TCS or PT\_REG.
- If the address in RCX points to a non-EPC page.
- If the address in RCX points to an invalid EPC page.

## EINIT—Initialize an Enclave for Execution

Opcode/ Instruction	Op/En	64/32 bit Mode Support	CPUID Feature Flag	Description
EAX = 02H ENCLS[EINIT]	IR	V/V	SGX1	This leaf function initializes the enclave and makes it ready to execute enclave code.

### Instruction Operand Encoding

Op/En	EAX		RBX	RCX	RDX
IR	EINIT (In)	Error code (Out)	Address of SIGSTRUCT (In)	Address of SECS (In)	Address of EINITTOKEN (In)

### Description

This leaf function is the final instruction executed in the enclave build process. After EINIT, the MRENCLAVE measurement is complete, and the enclave is ready to start user code execution using the EENTER instruction.

EINIT takes the effective address of a SIGSTRUCT and EINITTOKEN. The SIGSTRUCT describes the enclave including MRENCLAVE, ATTRIBUTES, ISVSVN, a 3072 bit RSA key, and a signature using the included key. SIGSTRUCT must be populated with two values, q1 and q2. These are calculated using the formulas shown below:

$$q1 = \text{floor}(\text{Signature}^2 / \text{Modulus});$$

$$q2 = \text{floor}((\text{Signature}^3 - q1 * \text{Signature} * \text{Modulus}) / \text{Modulus});$$

The EINITTOKEN contains the MRENCLAVE, MRSIGNER, and ATTRIBUTES. These values must match the corresponding values in the SECS. If the EINITTOKEN was created with a debug launch key, the enclave must be in debug mode as well.

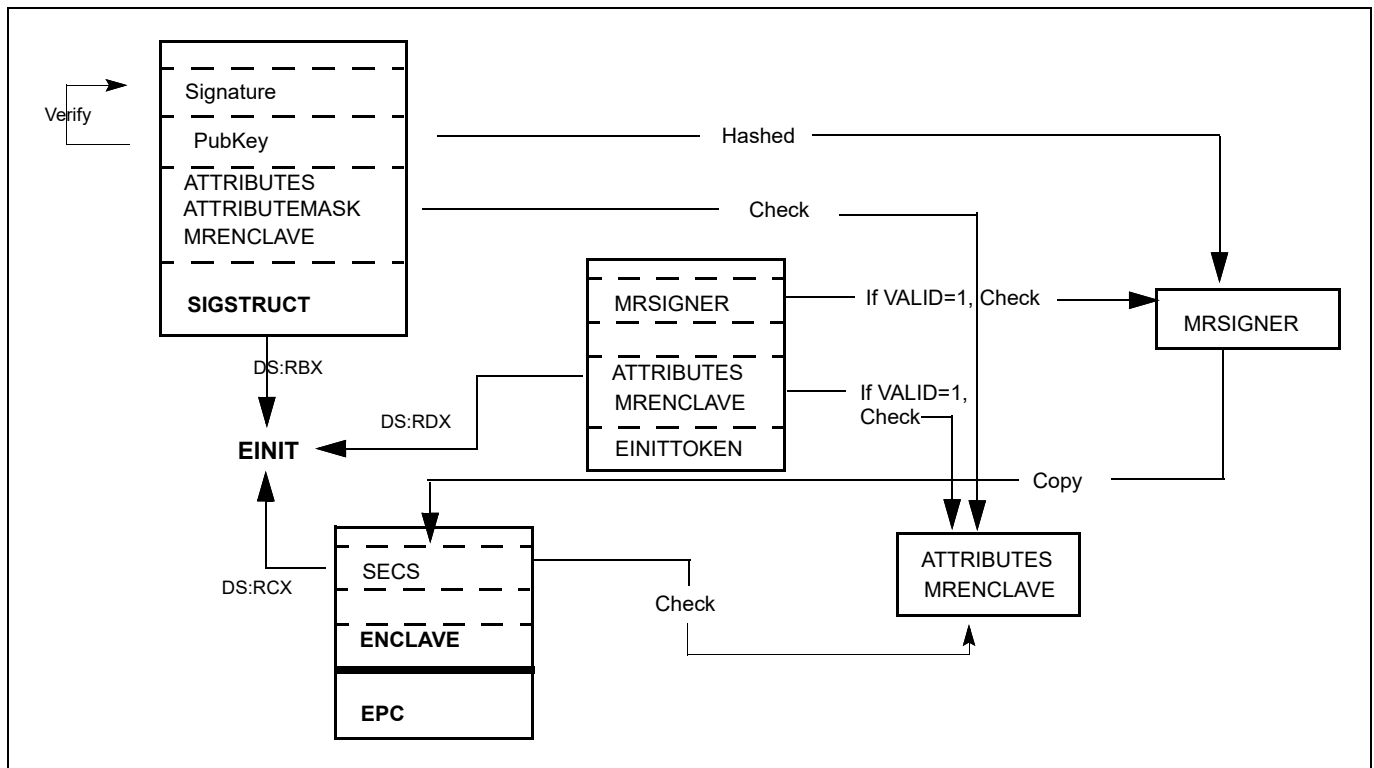

Figure 14-1. Relationships Between SECS, SIGSTRUCT, and EINITTOKEN

**EINIT Memory Parameter Semantics**

SIGSTRUCT	SECS	EINITTOKEN
Access by non-Enclave	Read/Write access by Enclave	Access by non-Enclave

EINIT performs the following steps, which can be seen in Figure 14-1:

1. Validates that SIGSTRUCT is signed using the enclosed public key.
2. Checks that the completed computation of SECS.MRENCLAVE equals SIGSTRUCT.HASHENCLAVE.
3. Checks that no controlled ATTRIBUTES bits are set in SIGSTRUCT.ATTRIBUTES unless the SHA256 digest of SIGSTRUCT.MODULUS equals IA32\_SGX\_LEPUBKEYHASH.
4. Checks that the result of bitwise and-ing SIGSTRUCT.ATTRIBUTEMASK with SIGSTRUCT.ATTRIBUTES equals the result of bitwise and-ing SIGSTRUCT.ATTRIBUTEMASK with SECS.ATTRIBUTES.
5. If EINITTOKEN.VALID is 0, checks that the SHA256 digest of SIGSTRUCT.MODULUS equals IA32\_SGX\_LEPUBKEYHASH.
6. If EINITTOKEN.VALID is 1, checks the validity of EINITTOKEN.
7. If EINITTOKEN.VALID is 1, checks that EINITTOKEN.MRENCLAVE equals SECS.MRENCLAVE.
8. If EINITTOKEN.VALID is 1 and EINITTOKEN.ATTRIBUTES.DEBUG is 1, SECS.ATTRIBUTES.DEBUG must be 1.
9. Commits SECS.MRENCLAVE, and sets SECS.MRSIGNER, SECS.ISVSVN, and SECS.ISVPRODID based on SIGSTRUCT.
10. Update the SECS as Initialized.

Periodically, EINIT polls for certain asynchronous events. If such an event is detected, it completes with failure code (ZF=1 and RAX = SGX\_UNMASKED\_EVENT), and RIP is incremented to point to the next instruction. These events includes external interrupts, non-maskable interrupts, system-management interrupts, machine checks, INIT signals, and the VMX-preemption timer. EINIT does not fail if the pending event is inhibited (e.g., external interrupts could be inhibited due to blocking by MOV SS blocking or by STI).

The following bits in RFLAGS are cleared: CF, PF, AF, OF, and SF. When the instruction completes with an error, RFLAGS.ZF is set to 1, and the corresponding error bit is set in RAX. If no error occurs, RFLAGS.ZF is cleared and RAX is set to 0.

The error codes are:

**Table 14-22. EINIT Return Value in RAX**

Error Code (see Table 14-12)	Description
No Error	EINIT successful.
SGX_INVALID_SIG_STRUCT	If SIGSTRUCT contained an invalid value.
SGX_INVALID_ATTRIBUTE	If SIGSTRUCT contains an unauthorized attributes mask.
SGX_INVALID_MEASUREMENT	If SIGSTRUCT contains an incorrect measurement. If EINITTOKEN contains an incorrect measurement.
SGX_INVALID_SIGNATURE	If signature does not validate with enclosed public key.
SGX_INVALID_LICENSE	If license is invalid.
SGX_INVALID_CPUSVN	If license SVN is unsupported.
SGX_UNMASKED_EVENT	If an unmasked event is received before the instruction completes its operation.



## Concurrency Restrictions

**Table 14-23. Base Concurrency Restrictions of EINIT**

Leaf	Parameter	Base Concurrency Restrictions		
		Access	On Conflict	SGX_CONFLICT VM Exit Qualification
EINIT	SECS [DS:RCX]	Shared	#GP	

**Table 14-24. Additional Concurrency Restrictions of EINIT**

Leaf	Parameter	Additional Concurrency Restrictions					
		vs. EACCEPT, EACCEPTCOPY, EMODPE, EMODPR, EMODT		vs. EADD, EEXTEND, EINIT		vs. ETRACK, ETRACKC	
		Access	On Conflict	Access	On Conflict	Access	On Conflict
EINIT	SECS [DS:RCX]	Concurrent		Exclusive	#GP	Concurrent	

## Operation

**Temp Variables in EINIT Operational Flow**

Name	Type	Size	Description
TMP_SIG	SIGSTRUCT	1808 Bytes	Temp space for SIGSTRUCT.
TMP_TOKEN	EINITTOKEN	304 Bytes	Temp space for EINITTOKEN.
TMP_MRENCLAVEBUF		48 Bytes	Temp space for calculating MRENCLAVE or MRENCLAVE384.
TMP_MRSIGNERBUF		48 Bytes	Temp space for calculating MRSIGNER or MRSIGNER384.
CONTROLLED_ATTRIBUTES	ATTRIBUTES	16 Bytes	Constant mask of all ATTRIBUTE bits that can only be set for authorized enclaves.
TMP_KEYDEPENDENCIES	Buffer	224 Bytes	Temp space for key derivation.
TMP_KEYCONTEXT	Buffer		Temp space for key derivation context.
TMP_TOKENKEY		16 Bytes	Temp space for the derived TOKEN Key.
TMP_SIG_PADDING	PKCS Padding Buffer	352 Bytes	The value of the top 352 bytes from the computation of Signature <sup>3</sup> modulo MRSIGNER.
TMP_SIG_PADDING_BUFFER	Buffer	704 Bytes	Buffer to combine TMP_SIG_PADDING with standard PKCS padding.

(\* make sure SIGSTRUCT and SECS are aligned \*)

```
IF ( (DS:RBX is not 4KByte Aligned) or (DS:RCX is not 4KByte Aligned) )
    THEN #GP(0); FI;
```

(\* make sure the EINITTOKEN is aligned \*)

```
IF (DS:RDX is not 512Byte Aligned)
    THEN #GP(0); FI;
```

(\* make sure the SECS is inside the EPC \*)

```
IF (DS:RCX does not resolve within an EPC)
    THEN #PF(DS:RCX); FI;
```

```
TMP_SIG[14463:0] := DS:RBX[14463:0]; // 1808 bytes
```

```
TMP_TOKEN[2423:0] := DS:RDX[2423:0]; // 304 bytes
```

```
(* Verify SIGSTRUCT Header. *)
```

```
IF ( (TMP_SIG.HEADER ≠ 06000000E1000000000010000000000h) or
    ((TMP_SIG.VENDOR ≠ 0) and (TMP_SIG.VENDOR ≠ 00008086h) ) or
    (TMP_SIG.HEADER2 ≠ 01010000600000006000000001000000h) or
    (TMP_SIG.EXPONENT ≠ 00000003h) or (Reserved space is not 0's) ) or
    (TMP_SIG.SIGHASHTYPE ≠ 0 AND TMP_SIG.SIGHASHTYPE ≠ 1)
```

```
THEN
```

```
    RFLAGS.ZF := 1;
    RAX := SGX_INVALID_SIG_STRUCT;
    GOTO EXIT;
```

```
FI;
```

```
(* Open "Event Window" Check for Interrupts. Verify signature using embedded public key, q1, and q2 with RSA-SHA256 or RSA-SHA384 as indicated by SIGHASHTYPE. Save upper bytes of the PKCS1.5 encoded message into the TMP_SIG_PADDING, 352 bytes for RSA-SHA256 and 336 bytes for RSA-SHA384. *)
```

```
IF (interrupt was pending) THEN
```

```
    RFLAGS.ZF := 1;
    RAX := SGX_UNMASKED_EVENT;
    GOTO EXIT;
```

```
FI
```

```
IF (signature failed to verify) THEN
```

```
    RFLAGS.ZF := 1;
    RAX := SGX_INVALID_SIGNATURE;
    GOTO EXIT;
```

```
FI;
```

```
(*Close "Event Window" *)
```

```
(* make sure no other Intel SGX instruction is modifying SECS*)
```

```
IF (Other instructions modifying SECS)
    THEN #GP(0); FI;
```

```
IF ( (EPCM(DS:RCX).VALID = 0) or (EPCM(DS:RCX).PT ≠ PT_SECS) )
    THEN #PF(DS:RCX); FI;
```

```
(* Verify ISVFAMILYID is not used on an enclave with KSS disabled *)
```

```
IF ((TMP_SIG.ISVFAMILYID != 0) AND (DS:RCX.ATTRIBUTES.KSS == 0))
    THEN
        RFLAGS.ZF := 1;
        RAX := SGX_INVALID_SIG_STRUCT;
        GOTO EXIT;
```

```
FI;
```

```
(* make sure no other instruction is accessing MRENCLAVE or ATTRIBUTES.INIT *)
```

```
IF ( (Other instruction modifying MRENCLAVE) or (Other instructions modifying the SECS's Initialized state))
    THEN #GP(0); FI;
```

```
(* Calculate finalized version of MRENCLAVE *)
```

```
IF (DS:RCX.ATTRIBUTES.SHA384 == 0)
    THEN
```

```
    (* SHA256 algorithm requires one last update that compresses the length of the hashed message into the output SHA256 digest *)
```

```

    TMP_ENCLAVEBUF := SHA256FINAL( DS:RCX.MRENCLAVE, enclave's MRENCLAVE update count *512);

(* Verify MRENCLAVE from SIGSTRUCT *)
IF ( (TMP_SIG.ENCLAVEHASH[2047:0] ≠ TMP_MRENCLAVEBUF[2047:0]) or
    (TMP_SIG.ENCLAVEHASH[3072:2048] ≠ 0) )
    THEN
        RFLAGS.ZF := 1;
        RAX := SGX_INVALID_MEASUREMENT;
        GOTO EXIT;
FI;

    TMP_MRSIGNERBUF := SHA256(TMP_SIG.MODULUS);
ELSE
(* SHA384 algorithm requires one last update that compresses the length of the hashed message into the output SHA384
digest *)
    TMP_ENCLAVEBUF := SHA384FINAL( DS:RCX.MRENCLAVE384, enclave's MRENCLAVE update count *1024);

(* Verify MRENCLAVE from SIGSTRUCT *)
IF (TMP_SIG.ENCLAVEHASH[3072:0] ≠ TMP_MRENCLAVEBUF[3072:0])
    THEN
        RFLAGS.ZF := 1;
        RAX := SGX_INVALID_MEASUREMENT;
        GOTO EXIT;
FI;

    TMP_MRSIGNERBUF := SHA384(TMP_SIG.MODULUS);
FI;

// Verify that the signing hash used on the SIGSTRUCT & enclave measurement
// are compatible.
IF (TMP_SIG.SIGHASHTYPE ≠ DS:RCX.ATTRIBUTES.SHA384)
    THEN
        RFLAGS.ZF := 1;
        RAX := SGX_INVALID_SIGSTRUCT;
        GOTO EXIT;
FI;

(* If controlled ATTRIBUTES are set, SIGSTRUCT must be signed using an authorized key *)
CONTROLLED_ATTRIBUTES := 0000000000000020H;
IF ( ( (DS:RCX.ATTRIBUTES & CONTROLLED_ATTRIBUTES) ≠ 0) and
    ( ((DS:RCX.ATTRIBUTES.SHA384 = 0) AND
    (TMP_MRSIGNERBUF[2047:0] ≠ IA32_SGXLEPUBKEYHASH[2047:0]) OR
    (IA32_SGXLEPUBKEYHASH[3071:2048] ≠ 0)) OR
    (DS:RCX.ATTRIBUTES.SHA384 = 1) AND
    (TMP_MRSIGNERBUF[3071:0] ≠ IA32_SGXLEPUBKEYHASH[3071:0])) ) )
    THEN
        RFLAGS.ZF := 1;
        RAX := SGX_INVALID_ATTRIBUTE;
        GOTO EXIT;
FI;

(* Verify SIGSTRUCT.ATTRIBUTE requirements are met *)
IF ( (DS:RCX.ATTRIBUTES & TMP_SIG.ATTRIBUTEMASK) ≠ (TMP_SIG.ATTRIBUTE & TMP_SIG.ATTRIBUTEMASK) )
    RFLAGS.ZF := 1;
    RAX := SGX_INVALID_ATTRIBUTE;

```

```
GOTO EXIT;
FI;

(*Verify SIGSTRUCT.MISCSELECT requirements are met *)
IF ( (DS:RCX.MISCSELECT & TMP_SIG.MISCMASK) ≠ (TMP_SIG.MISCSELECT & TMP_SIG.MISCMASK) )
    THEN
        RFLAGS.ZF := 1;
        RAX := SGX_INVALID_ATTRIBUTE;
    GOTO EXIT
FI;

IF (CPUID.(EAX=12H, ECX=1):EAX[6] = 1)
    IF ( DS:RCX.CET_ATTRIBUTES & TMP_SIG.CET_ATTRIBUTES_MASK ≠ TMP_SIG.CET_ATTRIBUTES &
        TMP_SIG.CET_ATTRIBUTES_MASK )
        THEN
            RFLAGS.ZF := 1;
            RAX := SGX_INVALID_ATTRIBUTE;
            GOTO EXIT
        FI;
    FI;

(* If EINITOKEN.VALID[0] is 0, verify the enclave is signed by an authorized key *)
IF (TMP_TOKEN.VALID[0] = 0)
    IF ( ((DS:RCX.ATTRIBUTES.SHA384 = 0) AND
        (TMP_MRSIGNERBUF[2047:0] ≠ IA32_SGXLEPUBKEYHASH[2047:0]) OR
        (IA32_SGXLEPUBKEYHASH[3071:2048] ≠ 0)) OR
        ((DS:RCX.ATTRIBUTES.SHA384 = 1) AND
        (TMP_MRSIGNERBUF[3071:0] ≠ IA32_SGXLEPUBKEYHASH[3071:0])))
        RFLAGS.ZF := 1;
        RAX := SGX_INVALID_EINITOKEN;
        GOTO EXIT;
    FI;
    GOTO COMMIT;
FI;

(* Debug Launch Enclave cannot launch Production Enclaves *)
IF ( (DS:RDX.MASKEDATTRIBUTESLE.DEBUG = 1) and (DS:RCX.ATTRIBUTES.DEBUG = 0) )
    THEN
        RFLAGS.ZF := 1;
        RAX := SGX_INVALID_EINITOKEN;
        GOTO EXIT;
    FI;

(* Check reserve space in EINIT token includes reserved regions and upper bits in valid field *)
IF (TMP_TOKEN reserved space is not clear)
    THEN
        RFLAGS.ZF := 1;
        RAX := SGX_INVALID_EINITOKEN;
        GOTO EXIT;
    FI;

(* EINIT token must not have been created by a configuration beyond the current CPU configuration *)
IF (TMP_TOKEN.CPUSVN must not be a configuration beyond CR_CPUSVN)
    THEN
```

```

RFLAGS.ZF := 1;
RAX := SGX_INVALID_CPUSVN;
GOTO EXIT;
FI;

(* Derive Launch key used to calculate EINITTOKEN.MAC *)
HARDCODED_PKCS1_5_PADDING[15:0] := 0100H;
HARDCODED_PKCS1_5_PADDING[2655:16] := SignExtend330Byte(-1); // 330 bytes of 0FFH
HARDCODED_PKCS1_5_PADDING[2815:2656] := 2004000501020403650148866009060D30313000H;
HARDCODED_PKCS1_5_PADDING[2831:2816] := 0100H;
HARDCODED_PKCS1_5_PADDING[5471:2832] := SignExtend314Byte(-1); // 314 bytes of 0FFH
HARDCODED_PKCS1_5_PADDING[5631:5472] := 3004000501020403650148866009060D30413000H;
HARDCODED_PKCS1_5_PADDING[5759:5632] := 0

HARDCODED_PKCS1_5_PADDING_HASH = SHA384(HARDCODED_PKCS1_5_PADDING);

TMP_KEYCONTEXT.KEYNAME := EINITTOKEN_KEY;
TMP_KEYDEPENDENCIES.ISVFAMILYID := 0;
TMP_KEYDEPENDENCIES.ISVEXTPRODID := 0;
TMP_KEYDEPENDENCIES.ISVPRODID := TMP_TOKEN.ISVPRODIDLE;
TMP_KEYDEPENDENCIES.ISVSVN := TMP_TOKEN.ISVSVNLE;
TMP_KEYDEPENDENCIES.ATTRIBUTES := TMP_TOKEN.MASKEDATTRIBUTESLE;
TMP_KEYDEPENDENCIES.ATTRIBUTESMASK := 0;
TMP_KEYDEPENDENCIES.MRENCLAVE := 0;
TMP_KEYDEPENDENCIES.MRSIGNER := IA32_SGXLEPUBKEYHASH;
TMP_KEYDEPENDENCIES.KEYID := TMP_TOKEN.KEYID;
TMP_KEYDEPENDENCIES.MISCSELECT := TMP_TOKEN.MASKEDMISCSELECTLE;
TMP_KEYDEPENDENCIES.MISCMASK := 0;
TMP_KEYDEPENDENCIES.PADDING := HARDCODED_PKCS1_5_PADDING_HASH;
TMP_KEYDEPENDENCIES.KEYPOLICY := 0;
TMP_KEYDEPENDENCIES.CONFIGID := 0;
TMP_KEYDEPENDENCIES.CONFIGSVN := 0;
IF (CPUID.(EAX=12H, ECX=1):EAX[6] = 1)
    TMP_KEYDEPENDENCIES.CET_ATTRIBUTES := TMP_TOKEN.CET_MASKED_ATTRIBUTES_LE;
    TMP_KEYDEPENDENCIES.CET_ATTRIBUTES_MASK := 0;
FI;

IF (TMP_TOKEN.VALID.LE256 = 0)
THEN
    (* Calculate the derived key*)
    TMP_TOKENKEY := derivekey(TMP_EINITTOKEN.CPUSVNLE,
        TRUE, // Include Seal Fuses
        TRUE, // Include Owner Epoch
        SHA384(TMP_KEYDEPENDENCIES),
        TMP_KEYCONTEXT,
        128);

    (* Verify EINITTOKEN was generated using this CPU's Launch key and that it has not been modified since issuing by the Launch
    Enclave. Only 192 bytes of EINITTOKEN are CMACed *)
    IF (TMP_TOKEN.MAC ≠ CMAC(TMP_TOKENKEY, TMP_TOKEN[1535:0] ))
    THEN
        RFLAGS.ZF := 1;
        RAX := SGX_INVALID_EINITTOKEN;
        GOTO EXIT;
    
```

```

FI;
ELSE
  THEN
    (* Calculate the derived key*)
    TMP_TOKENKEY := derivekey(TMP_TOKEN.CPUSVNLE,
                              TRUE, // Include Seal Fuses
                              TRUE, // Include Owner Epoch
                              SHA384(TMP_KEYDEPENDENCIES),
                              TMP_KEYCONTEXT,
                              256);

    (* Verify EINITOKEN was generated using this CPU's Launch key and that it has not been modified since issuing by the
    Launch Enclave. Only 192 bytes of EINITOKEN are CMACed *)
    (* Note: 256 bit HMAC is stored in 256 bit KEYID field since KEYID is not needed, and MAC field is only 128 bits long. *)
    IF (TMP_TOKEN.KEYID ≠ HMAC(TMP_EINITOKENKEY, TMP_TOKEN[1535:0]))
      THEN
        RFLAGS.ZF := 1;
        RAX := SGX_INVALID_EINITOKEN;
        GOTO EXIT;

    FI;
  FI;

  (* Ensure token meets Launch control enabling type *)
  IF (IA32_SGXLECONFIG[0] ≠ TMP_EINITOKEN.VALID.LE256)
    THEN
      RFLAGS.ZF := 1;
      RAX := SGX_INVALID_EINITOKEN;
      GOTO EXIT;

  FI;

  (* Verify EINITOKEN (RDX) is for this enclave *)
  IF (TMP_SECS.ATTRIBUTES.SHA384 = 0)
    IF ((TMP_TOKEN.MRENCLAVE[2047:0] ≠ TMP_MRENCLAVEBUF[2047:0]) OR
        (TMP_TOKEN.MRENCLAVE[3071:2048] ≠ 0) OR
        (TMP_TOKEN.MRSIGNER[2047:0] ≠ TMP_MRSIGNERBUF[2047:0]) OR
        (TMP_TOKEN.MRSIGNER[3071:2048] ≠ 0))
      THEN
        RFLAGS.ZF := 1;
        RAX := SGX_INVALID_MEASUREMENT;
        GOTO EXIT;

    FI;
  ELSE
    IF ((TMP_EINITOKEN.MRENCLAVE[3071:0] ≠ TMP_MRENCLAVEBUF[3071:0]) OR
        (TMP_EINITOKEN.MRSIGNER[3071:0] ≠ TMP_MRSIGNERBUF[3071:0]))
      THEN
        RFLAGS.ZF := 1;
        RAX := SGX_INVALID_MEASUREMENT;
        GOTO EXIT;

    FI;
  FI;

  (* Verify ATTRIBUTES in EINITOKEN are the same as the enclave's *)

```

```

IF (TMP_TOKEN.ATTRIBUTES ≠ DS:RCX.ATTRIBUTES)
  RFLAGS.ZF := 1;
  RAX := SGX_INVALID_EINIT_ATTRIBUTE;
  GOTO EXIT;
FI;

COMMIT:
(* Commit changes to the SECS; Set ISVPRODID, ISVSVN, MRSIGNER, INIT ATTRIBUTE fields in SECS (RCX) *)
IF (DS:RCX.ATTRIBUTES.SHA384 == 0)
  THEN
    (* Use MRENCLAVE and MRSIGNER, zero MRENCLAVE384 and MRSIGNER384. *)
    DS:RCX.MRENCLAVE384 := 0;
    DS:RCX.MRENCLAVE := TMP_MRENCLAVEBUF[2047:0];
    (* MRSIGNER stores a SHA256 in little endian implemented natively on x86. *)
    DS:RCX.MRSIGNER384 := 0;
    DS:RCX.MRSIGNER := TMP_MRSIGNERBUF[2047:0];

    (* Padding buff strategy is a correctly signed enclave using either SHA256 or SHA384. *)
    (* Results in a Padding Buff = PKCS (SHA256 padding || PKCS SHA384 padding) *)
    (* Populate Sig Padding Buffer with enclave's actual PKCS SHA256 padding and standard PKCS SHA384 padding. *)
    TMP_SIG_PADDING_BUFFER[351:0B] = TMP_SIG_PADDING;
    TMP_SIG_PADDING_BUFFER[2831:2816] := 0100H;
    TMP_SIG_PADDING_BUFFER[5471:2832] := SignExtend314Byte(-1); // 314 bytes of 0FFH
    TMP_SIG_PADDING_BUFFER [5631:5472] := 3004000501020403650148866009060D30413000H;
    TMP_SIG_PADDING_BUFFER[5759:5632] := 0;

  ELSE
    THEN
      // Use MRENCLAVE384 and MRSIGNER384, compute MRENCLAVE and MRSIGNER
      DS:RCX.MRENCLAVE384 := TMP_MRENCLAVEBUF[3071:0];
      DS:RCX.MRENCLAVE := SHA256(TMP_MRENCLAVEBUF[3071:0]);
      DS:RCX.MRSIGNER384 := TMP_MRSIGNERBUF[3071:0];
      DS:RCX.MRSIGNER := SHA256(TMP_SIG.MODULUS);

      (* Padding buff strategy is a correctly signed enclave using either SHA256 or SHA384. *)
      (* Results in a Padding Buff = PKCS (SHA256 padding || PKCS SHA384 padding) *)
      (* Populate Sig Padding Buffer with standard PKCS SHA256 padding and enclave's actual PKCS SHA384 padding. *)
      TMP_SIG_PADDING_BUFFER[15:0] := 0100H;
      TMP_SIG_PADDING_BUFFER[2655:16] := SignExtend330Byte(-1); // 330 bytes of 0FFH
      TMP_SIG_PADDING_BUFFER[2815:2656] := 2004000501020403650148866009060D30313000H;
      TMP_SIG_PADDING_BUFFER[5631:2816] := TMP_SIG_PADDING;
      TMP_SIG_PADDING_BUFFER[5759:5632] := 0;

  FI;

DS:RCX.ISVEXTPRODID := TMP_SIG.ISVEXTPRODID;
DS:RCX.ISVPRODID := TMP_SIG.ISVPRODID;
DS:RCX.ISVSVN := TMP_SIG.ISVSVN;
DS:RCX.ISVFAMILYID := TMP_SIG.ISVFAMILYID;
DS:RCX.PADDING := SHA384(TMP_SIG_PADDING_BUFFER);

(* Mark the SECS as initialized *)
Update DS:RCX to initialized;

(* Set RAX and ZF for success*)

```

```
RFLAGS.ZF := 0;
RAX := 0;
EXIT:
RFLAGS.CF,PF,AF,OF,SF := 0;
```

### Flags Affected

ZF is cleared if successful, otherwise ZF is set and RAX contains the error code. CF, PF, AF, OF, SF are cleared.

### Protected Mode Exceptions

#GP(0)	If a memory operand is not properly aligned. If another instruction is modifying the SECS. If the enclave is already initialized. If the SECS.MRENCLAVE is in use.
#PF(error code)	If a page fault occurs in accessing memory operands. If RCX does not resolve in an EPC page. If the memory address is not a valid, uninitialized SECS.

### 64-Bit Mode Exceptions

#GP(0)	If a memory operand is not properly aligned. If another instruction is modifying the SECS. If the enclave is already initialized. If the SECS.MRENCLAVE is in use.
#PF(error code)	If a page fault occurs in accessing memory operands. If RCX does not resolve in an EPC page. If the memory address is not a valid, uninitialized SECS.



## ELDB/ELDU/ELDBC/ELDUC—Load an EPC Page and Mark its State

Opcode/ Instruction	Op/En	64/32 bit Mode Support	CPUID Feature Flag	Description
EAX = 07H ENCLS[ELDB]	IR	V/V	SGX1	This leaf function loads, verifies an EPC page and marks the page as blocked.
EAX = 08H ENCLS[ELDU]	IR	V/V	SGX1	This leaf function loads, verifies an EPC page and marks the page as unblocked.
EAX = 12H ENCLS[ELDBC]	IR	V/V	EAX[6]	This leaf function behaves like ELDB but with improved conflict handling for oversubscription.
EAX = 13H ENCLS[ELDUC]	IR	V/V	EAX[6]	This leaf function behaves like ELDU but with improved conflict handling for oversubscription.

### Instruction Operand Encoding

Op/En	EAX		RBX	RCX	RDX
IR	ELDB/ELDU (In)	Return error code (Out)	Address of the PAGEINFO (In)	Address of the EPC page (In)	Address of the version- array slot (In)

#### Description

This leaf function copies a page from regular main memory to the EPC. As part of the copying process, the page is cryptographically authenticated and decrypted. This instruction can only be executed when current privilege level is 0.

The ELDB leaf function sets the BLOCK bit in the EPCM entry for the destination page in the EPC after copying. The ELDU leaf function clears the BLOCK bit in the EPCM entry for the destination page in the EPC after copying.

RBX contains the effective address of a PAGEINFO structure; RCX contains the effective address of the destination EPC page; RDX holds the effective address of the version array slot that holds the version of the page.

The ELDBC/ELDUC leafs are very similar to ELDB and ELDU. They provide an error code on the concurrency conflict for any of the pages which need to acquire a lock. These include the destination, SECS, and VA slot.

The table below provides additional information on the memory parameter of ELDB/ELDU leaf functions.

### ELDB/ELDU/ELDBC/ELBUC Memory Parameter Semantics

PAGEINFO	PAGEINFO.SRCPGE	PAGEINFO.PCMD	PAGEINFO.SECS	EPCPAGE	Version-Array Slot
Non-enclave read access	Non-enclave read access	Non-enclave read access	Enclave read/write access	Read/Write access permitted by Enclave	Read/Write access permitted by Enclave

The error codes are:

**Table 14-25. ELDB/ELDU/ELDBC/ELBUC Return Value in RAX**

Error Code (see Table 14-12)	Description
No Error	ELDB/ELDU successful.
SGX_MAC_COMPARE_FAIL	If the MAC check fails.

## Concurrency Restrictions

**Table 14-26. Base Concurrency Restrictions of ELDB/ELDU/ELDBC/ELBUC**

Leaf	Parameter	Base Concurrency Restrictions		
		Access	On Conflict	SGX_CONFLICT VM Exit Qualification
ELDB/ELDU	Target [DS:RCX]	Exclusive	#GP	EPC_PAGE_CONFLICT_EXCEPTION
	VA [DS:RDX]	Shared	#GP	
	SECS [DS:RBX]PAGEINFO.SECS	Shared	#GP	
ELDBC/ELBUC	Target [DS:RCX]	Exclusive	SGX_EPC_PAGE_-CONFLICT	EPC_PAGE_CONFLICT_ERROR
	VA [DS:RDX]	Shared	SGX_EPC_PAGE_-CONFLICT	
	SECS [DS:RBX]PAGEINFO.SECS	Shared	SGX_EPC_PAGE_-CONFLICT	

**Table 14-27. Additional Concurrency Restrictions of ELDB/ELDU/ELDBC/ELBUC**

Leaf	Parameter	Additional Concurrency Restrictions					
		vs. EACCEPT, EACCEPTCOPY, EMODPE, EMODPR, EMODT		vs. EADD, EEXTEND, EINIT		vs. ETRACK, ETRACKC	
		Access	On Conflict	Access	On Conflict	Access	On Conflict
ELDB/ELDU	Target [DS:RCX]	Concurrent		Concurrent		Concurrent	
	VA [DS:RDX]	Concurrent		Concurrent		Concurrent	
	SECS [DS:RBX]PAGEINFO.SECS	Concurrent		Concurrent		Concurrent	
ELDBC/ELBUC	Target [DS:RCX]	Concurrent		Concurrent		Concurrent	
	VA [DS:RDX]	Concurrent		Concurrent		Concurrent	
	SECS [DS:RBX]PAGEINFO.SECS	Concurrent		Concurrent		Concurrent	

## Operation

**Temp Variables in ELDB/ELDU/ELDBC/ELBUC Operational Flow**

Name	Type	Size (Bits)	Description
TMP_SRCPGE	Memory page	4KBytes	
TMP_SECS	Memory page	4KBytes	
TMP_PCMD	PCMD	128 Bytes	
TMP_HEADER	MACHEADER	128 Bytes	
TMP_VER	UINT64	64	
TMP_MAC	UINT128	128	
TMP_PG_KEY	UINT256	256	Page encryption/MAC key.
SCRATCH_PCMD	PCMD	128 Bytes	

(\* Check PAGEINFO and EPCPAGE alignment \*)  
 IF ( (DS:RBX is not 32Byte Aligned) or (DS:RCX is not 4KByte Aligned) )  
 THEN #GP(0); FI;

```
IF (DS:RCX does not resolve within an EPC)
  THEN #PF(DS:RCX); FI;
```

```
(* Check VASLOT alignment *)
IF (DS:RDX is not 8Byte aligned)
  THEN #GP(0); FI;
```

```
IF (DS:RDX does not resolve within an EPC)
  THEN #PF(DS:RDX); FI;
```

```
TMP_SRCPGE := DS:RBX.SRCPGE;
TMP_SECS := DS:RBX.SECS;
TMP_PCMD := DS:RBX.PCMD;
```

```
(* Check alignment of PAGEINFO (RBX) linked parameters. Note: PCMD pointer is overlaid on top of PAGEINFO.SECINFO field *)
IF ( (DS:TMP_PCMD is not 128Byte aligned) or (DS:TMP_SRCPGE is not 4KByte aligned) )
  THEN #GP(0); FI;
```

```
(* Check concurrency of EPC by other Intel SGX instructions *)
IF (other instructions accessing EPC)
  THEN
    IF ((EAX==07h) OR (EAX==08h)) (* ELDB/ELDU *)
      THEN
        IF (<<VMX non-root operation>> AND
            <<ENABLE_EPC_VIRTUALIZATION_EXTENSIONS>>)
          THEN
            VMCS.Exit_reason := SGX_CONFLICT;
            VMCS.Exit_qualification.code := EPC_PAGE_CONFLICT_EXCEPTION;
            VMCS.Exit_qualification.error := 0;
            VMCS.Guest-physical_address :=
              << translation of DS:RCX produced by paging >>;
            VMCS.Guest-linear_address := DS:RCX;
            Deliver VMEXIT;
          ELSE
            #GP(0);
          FI;
        ELSE (* ELDBC/ELDUC *)
          IF (<<VMX non-root operation>> AND
              <<ENABLE_EPC_VIRTUALIZATION_EXTENSIONS>>)
            THEN
              VMCS.Exit_reason := SGX_CONFLICT;
              VMCS.Exit_qualification.code := EPC_PAGE_CONFLICT_ERROR;
              VMCS.Exit_qualification.error := SGX_EPC_PAGE_CONFLICT;
              VMCS.Guest-physical_address :=
                << translation of DS:RCX produced by paging >>;
              VMCS.Guest-linear_address := DS:RCX;
              Deliver VMEXIT;
            ELSE
              RFLAGS.ZF := 1;
              RFLAGS.CF := 0;
              RAX := SGX_EPC_PAGE_CONFLICT;
              GOTO ERROR_EXIT;
            FI;
          FI;
```

```

    FI;
FI;

(* Check concurrency of EPC and VASLOT by other Intel SGX instructions *)
IF (Other instructions modifying VA slot) THEN
    IF ((EAX==07h) OR (EAX==08h)) (* ELDB/ELDU *)
        THEN #GP(0);
    ELSE (* ELDBC/ELDUC *)
        RFLAGS.ZF := 1;
        RFLAGS.CF := 0;
        RAX := SGX_EPC_PAGE_CONFLICT;
        GOTO ERROR_EXIT;
    FI;
FI;

(* Verify EPCM attributes of EPC page, VA, and SECS *)
IF (EPCM(DS:RCX).VALID = 1)
    THEN #PF(DS:RCX); FI;

IF ( (EPCM(DS:RDX & ~OFFFH).VALID = 0) or (EPCM(DS:RDX & ~OFFFH).PT ≠ PT_VA) )
    THEN #PF(DS:RDX); FI;

(* Copy PCMD into scratch buffer *)
SCRATCH_PCMD[1023: 0] := DS:TMP_PCMD[1023:0];

(* Zero out TMP_HEADER*)
TMP_HEADER[sizeof(TMP_HEADER)-1: 0] := 0;

TMP_HEADER.SECINFO := SCRATCH_PCMD.SECINFO;
TMP_HEADER.RSVD := SCRATCH_PCMD.RSVD;
TMP_HEADER.LINADDR := DS:RBX.LINADDR;

(* Verify various attributes of SECS parameter *)
IF ( (TMP_HEADER.SECINFO.FLAGS.PT = PT_REG) or (TMP_HEADER.SECINFO.FLAGS.PT = PT_TCS) or
    (TMP_HEADER.SECINFO.FLAGS.PT = PT_TRIM) or
    (TMP_HEADER.SECINFO.FLAGS.PT = PT_SS_FIRST and CPUID.(EAX=12H, ECX=1):EAX[6] = 1) or
    (TMP_HEADER.SECINFO.FLAGS.PT = PT_SS_REST and CPUID.(EAX=12H, ECX=1):EAX[6] = 1) )
    THEN
        IF ( DS:TMP_SECS is not 4KByte aligned)
            THEN #GP(0) FI;
        IF (DS:TMP_SECS does not resolve within an EPC)
            THEN #PF(DS:TMP_SECS) FI;
        IF ( Another instruction is currently modifying the SECS) THEN
            IF ((EAX==07h) OR (EAX==08h)) (* ELDB/ELDU *)
                THEN #GP(0);
            ELSE (* ELDBC/ELDUC *)
                RFLAGS.ZF := 1;
                RFLAGS.CF := 0;
                RAX := SGX_EPC_PAGE_CONFLICT;
                GOTO ERROR_EXIT;
            FI;
        FI;
        TMP_HEADER.EID := DS:TMP_SECS.EID;
    ELSE

```

```
(* TMP_HEADER.SECINFO.FLAGS.PT is PT_SECS or PT_VA which do not have a parent SECS, and hence no EID binding *)
TMP_HEADER.EID := 0;
IF (DS:TMP_SECS ≠ 0)
    THEN #GP(0) FI;
```

```
FI;
```

```
(* Copy 4KBytes SRCPGE to secure location *)
DS:RCX[32767: 0] := DS:TMP_SRCPGE[32767: 0];
TMP_VER := DS:RDX[63:0];
```

```
(* Derive version-unique paging key *)
TMP_PG_KEY := derivePK(TMP_VER);
```

```
(* Decrypt and MAC page. AES_GCM_DEC has 2 outputs, {plain text, MAC} *)
(* Parameters for AES_GCM_DEC {Key, Counter, ..} *)
{DS:RCX, TMP_MAC} := AES256_GCM_DEC(TMP_PG_KEY, 0, TMP_HEADER, 128, DS:RCX, 4096);
```

```
IF ( (TMP_MAC ≠ DS:TMP_PCMD.MAC) )
    THEN
        RFLAGS.ZF := 1;
        RAX := SGX_MAC_COMPARE_FAIL;
        GOTO ERROR_EXIT;
```

```
FI;
```

```
(* Clear VA Slot *)
DS:RDX := 0
```

```
(* Commit EPCM changes *)
EPCM(DS:RCX).PT := TMP_HEADER.SECINFO.FLAGS.PT;
EPCM(DS:RCX).RWX := TMP_HEADER.SECINFO.FLAGS.RWX;
EPCM(DS:RCX).PENDING := TMP_HEADER.SECINFO.FLAGS.PENDING;
EPCM(DS:RCX).MODIFIED := TMP_HEADER.SECINFO.FLAGS.MODIFIED;
EPCM(DS:RCX).PR := TMP_HEADER.SECINFO.FLAGS.PR;
EPCM(DS:RCX).ENCLAVEADDRESS := TMP_HEADER.LINADDR;
```

```
IF ( ((EAX = 07H) or (EAX = 12H)) and (TMP_HEADER.SECINFO.FLAGS.PT is NOT PT_SECS or PT_VA))
    THEN
        EPCM(DS:RCX).BLOCKED := 1;
    ELSE
        EPCM(DS:RCX).BLOCKED := 0;
```

```
FI;
```

```
IF (TMP_HEADER.SECINFO.FLAGS.PT is PT_SECS)
    << store translation of DS:RCX produced by paging in SECS(DS:RCX).ENCLAVECONTEXT >>
FI;
```

```
EPCM(DS:RCX). VALID := 1;
```

```
RAX := 0;
RFLAGS.ZF := 0;
```

```
ERROR_EXIT:
RFLAGS.CF,PF,AF,OF,SF := 0;
```

**Flags Affected**

Sets ZF if unsuccessful, otherwise cleared and RAX returns error code. Clears CF, PF, AF, OF, SF.

**Protected Mode Exceptions**

#GP(0)	If a memory operand effective address is outside the DS segment limit. If a memory operand is not properly aligned. If the instruction's EPC resource is in use by others. If the instruction fails to verify MAC. If the version-array slot is in use. If the parameters fail consistency checks.
#PF(error code)	If a page fault occurs in accessing memory operands. If a memory operand expected to be in EPC does not resolve to an EPC page. If one of the EPC memory operands has incorrect page type. If the destination EPC page is already valid.

**64-Bit Mode Exceptions**

#GP(0)	If a memory operand is non-canonical form. If a memory operand is not properly aligned. If the instruction's EPC resource is in use by others. If the instruction fails to verify MAC. If the version-array slot is in use. If the parameters fail consistency checks.
#PF(error code)	If a page fault occurs in accessing memory operands. If a memory operand expected to be in EPC does not resolve to an EPC page. If one of the EPC memory operands has incorrect page type. If the destination EPC page is already valid.

## EWB—Invalidate an EPC Page and Write out to Main Memory

Opcode/ Instruction	Op/En	64/32 bit Mode Support	CPUID Feature Flag	Description
EAX = 0BH ENCLS[EWB]	IR	V/V	SGX1	This leaf function invalidates an EPC page and writes it out to main memory.

### Instruction Operand Encoding

Op/En	EAX		RBX	RCX	RDX
IR	EWB (In)	Error code (Out)	Address of an PAGEINFO (In)	Address of the EPC page (In)	Address of a VA slot (In)

#### Description

This leaf function copies a page from the EPC to regular main memory. As part of the copying process, the page is cryptographically protected. This instruction can only be executed when current privilege level is 0.

The table below provides additional information on the memory parameter of EPA leaf function.

### EWB Memory Parameter Semantics

PAGEINFO	PAGEINFO.SRCPGE	PAGEINFO.PCMD	EPCPAGE	VASLOT
Non-EPC R/W access	Non-EPC R/W access	Non-EPC R/W access	EPC R/W access	EPC R/W access

The error codes are:

**Table 14-28. EWB Return Value in RAX**

Error Code (see Table 14-12)	Description
No Error	EWB successful.
SGX_PAGE_NOT_BLOCKED	If page is not marked as blocked.
SGX_NOT_TRACKED	If EWB is racing with ETRACK instruction.
SGX_VA_SLOT_OCCUPIED	Version array slot contained valid entry.
SGX_CHILD_PRESENT	Child page present while attempting to page out enclave.

#### Concurrency Restrictions

**Table 14-29. Base Concurrency Restrictions of EWB**

Leaf	Parameter	Base Concurrency Restrictions		
		Access	On Conflict	SGX_CONFLICT VM Exit Qualification
EWB	Source [DS:RCX]	Exclusive	#GP	EPC_PAGE_CONFLICT_EXCEPTION
	VA [DS:RDX]	Shared	#GP	

**Table 14-30. Additional Concurrency Restrictions of EWB**

Leaf	Parameter	Additional Concurrency Restrictions					
		vs. EACCEPT, EACCEPTCOPY, EMODPE, EMODPR, EMODT		vs. EADD, EEXTEND, EINIT		vs. ETRACK, ETRACKC	
		Access	On Conflict	Access	On Conflict	Access	On Conflict
EWB	Source [DS:RCX]	Concurrent		Concurrent		Concurrent	
	VA [DS:RDX]	Concurrent		Concurrent		Exclusive	

## Operation

## Temp Variables in EWB Operational Flow

Name	Type	Size (Bytes)	Description
TMP_SRCPGE	Memory page	4096	
TMP_PCMD	PCMD	128	
TMP_SECS	SECS	4096	
TMP_BPEPOCH	UINT64	8	
TMP_BPREFCOUNT	UINT64	8	
TMP_HEADER	MAC Header	128	
TMP_PCMD_ENCLAVEID	UINT64	8	
TMP_VER	UINT64	8	
TMP_PG_KEY	UINT256	32	

```
IF ( (DS:RBX is not 32Byte Aligned) or (DS:RCX is not 4KByte Aligned) )
    THEN #GP(0); FI;
```

```
IF (DS:RCX does not resolve within an EPC)
    THEN #PF(DS:RCX); FI;
```

```
IF (DS:RDX is not 8Byte Aligned)
    THEN #GP(0); FI;
```

```
IF (DS:RDX does not resolve within an EPC)
    THEN #PF(DS:RDX); FI;
```

```
(* EPCPAGE and VASLOT should not resolve to the same EPC page*)
IF (DS:RCX and DS:RDX resolve to the same EPC page)
    THEN #GP(0); FI;
```

```
TMP_SRCPGE := DS:RBX.SRCPGE;
(* Note PAGEINFO.PCMD is overlaid on top of PAGEINFO.SECINFO *)
TMP_PCMD := DS:RBX.PCMD;
```

```
If (DS:RBX.LINADDR ≠ 0) OR (DS:RBX.SECS ≠ 0)
    THEN #GP(0); FI;
```

```
IF ( (DS:TMP_PCMD is not 128Byte Aligned) or (DS:TMP_SRCPGE is not 4KByte Aligned) )
    THEN #GP(0); FI;
```

```
(* Check for concurrent Intel SGX instruction access to the page *)
IF (Other Intel SGX instruction is accessing page)
    THEN
        IF (<<VMX non-root operation>> AND <<ENABLE_EPC_VIRTUALIZATION_EXTENSIONS>>)
            THEN
                VMCS.Exit_reason := SGX_CONFLICT;
                VMCS.Exit_qualification.code := EPC_PAGE_CONFLICT_EXCEPTION;
                VMCS.Exit_qualification.error := 0;
                VMCS.Guest-physical_address := << translation of DS:RCX produced by paging >>;
```



```

        VMCS.Guest-linear_address := DS:RCX;
        Deliver VMEXIT;
    ELSE
        #GP(0);
FI;
FI;

(*Check if the VA Page is being removed or changed*)
IF (VA Page is being modified)
    THEN #GP(0); FI;

(* Verify that EPCPAGE and VASLOT page are valid EPC pages and DS:RDX is VA *)
IF (EPCM(DS:RCX).VALID = 0)
    THEN #PF(DS:RCX); FI;

IF ( (EPCM(DS:RDX & ~OFFFH).VALID = 0) or (EPCM(DS:RDX & ~FFFH).PT is not PT_VA) )
    THEN #PF(DS:RDX); FI;

(* Perform page-type-specific exception checks *)
IF ( (EPCM(DS:RCX).PT is PT_REG) or (EPCM(DS:RCX).PT is PT_TCS) or (EPCM(DS:RCX).PT is PT_TRIM) or
    (EPCM(DS:RCX).PT is PT_SS_FIRST) or (EPCM(DS:RCX).PT is PT_SS_REST))
    THEN
        TMP_SECS = Obtain SECS through EPCM(DS:RCX)
        (* Check that EBLOCK has occurred correctly *)
        IF (EBLOCK is not correct)
            THEN #GP(0); FI;
FI;

RFLAGS.ZF,CF,PF,AF,OF,SF := 0;
RAX := 0;

(* Zero out TMP_HEADER*)
TMP_HEADER[ sizeof(TMP_HEADER) - 1 : 0 ] := 0;

(* Perform page-type-specific checks *)
IF ( (EPCM(DS:RCX).PT is PT_REG) or (EPCM(DS:RCX).PT is PT_TCS) or (EPCM(DS:RCX).PT is PT_TRIM) or
    (EPCM(DS:RCX).PT is PT_SS_FIRST) or (EPCM(DS:RCX).PT is PT_SS_REST))
    THEN
        (* check to see if the page is evictable *)
        IF (EPCM(DS:RCX).BLOCKED = 0)
            THEN
                RAX := SGX_PAGE NOT_BLOCKED;
                RFLAGS.ZF := 1;
                GOTO ERROR_EXIT;
        FI;
        (* Check if tracking done correctly *)
        IF (Tracking not correct)
            THEN
                RAX := SGX_NOT_TRACKED;
                RFLAGS.ZF := 1;
                GOTO ERROR_EXIT;
        FI;

        (* Obtain EID to establish cryptographic binding between the paged-out page and the enclave *)

```

```
TMP_HEADER.EID := TMP_SECS.EID;
```

```
(* Obtain EID as an enclave handle for software *)
```

```
TMP_PCMD_ENCLAVEID := TMP_SECS.EID;
```

```
ELSE IF (EPCM(DS:RCX).PT is PT_SECS)
```

```
(*check that there are no child pages inside the enclave *)
```

```
IF (DS:RCX has an EPC page associated with it)
```

```
THEN
```

```
    RAX := SGX_CHILD_PRESENT;
```

```
    RFLAGS.ZF := 1;
```

```
    GOTO ERROR_EXIT;
```

```
FI;
```

```
(* treat SECS as having a child page when VIRTCHILDCNT is non-zero *)
```

```
IF (<<in VMX non-root operation>> AND
```

```
<<ENABLE_EPC_VIRTUALIZATION_EXTENSIONS>> AND
```

```
(SECS(DS:RCX).VIRTCHILDCNT ≠ 0))
```

```
THEN
```

```
    RFLAGS.ZF := 1;
```

```
    RAX := SGX_CHILD_PRESENT;
```

```
    GOTO ERROR_EXIT;
```

```
FI;
```

```
TMP_HEADER.EID := 0;
```

```
(* Obtain EID as an enclave handle for software *)
```

```
TMP_PCMD_ENCLAVEID := (DS:RCX).EID;
```

```
ELSE IF (EPCM(DS:RCX).PT is PT_VA)
```

```
TMP_HEADER.EID := 0; // Zero is not a special value
```

```
(* No enclave handle for VA pages*)
```

```
TMP_PCMD_ENCLAVEID := 0;
```

```
FI;
```

```
TMP_HEADER.LINADDR := EPCM(DS:RCX).ENCLAVEADDRESS;
```

```
TMP_HEADER.SECINFO.FLAGS.PT := EPCM(DS:RCX).PT;
```

```
TMP_HEADER.SECINFO.FLAGS.RWX := EPCM(DS:RCX).RWX;
```

```
TMP_HEADER.SECINFO.FLAGS.PENDING := EPCM(DS:RCX).PENDING;
```

```
TMP_HEADER.SECINFO.FLAGS.MODIFIED := EPCM(DS:RCX).MODIFIED;
```

```
TMP_HEADER.SECINFO.FLAGS.PR := EPCM(DS:RCX).PR;
```

```
(* Derive paging key *)
```

```
TMP_PG_KEY = derivePK(TMP_VER);
```

```
(* Encrypt the page, DS:RCX could be encrypted in place. AES-GCM produces 2 values, {ciphertext, MAC}. *)
```

```
(* AES-GCM input parameters: key, GCM Counter, MAC_HDR, MAC_HDR_SIZE, SRC, SRC_SIZE*)
```

```
{DS:TMP_SRCPGE, DS:TMP_PCMD.MAC} := AES256_GCM_ENC(TMP_PG_KEY, 0, TMP_HEADER, 128, DS:RCX, 4096);
```

```
(* Write the output *)
```

```
Zero out DS:TMP_PCMD.SECINFO
```

```
DS:TMP_PCMD.SECINFO.FLAGS.PT := EPCM(DS:RCX).PT;
```

```
DS:TMP_PCMD.SECINFO.FLAGS.RWX := EPCM(DS:RCX).RWX;
```

```
DS:TMP_PCMD.SECINFO.FLAGS.PENDING := EPCM(DS:RCX).PENDING;
```

```
DS:TMP_PCMD.SECINFO.FLAGS.MODIFIED := EPCM(DS:RCX).MODIFIED;
```

```
DS:TMP_PCMD.SECINFO.FLAGS.PR := EPCM(DS:RCX).PR;
```

```
DS:TMP_PCMD.RESERVED := 0;
```

```
DS:TMP_PCMD.ENCLAVEID := TMP_PCMD_ENCLAVEID;
```

```
DS:RBX.LINADDR := EPCM(DS:RCX).ENCLAVEADDRESS;
```

```
(*Check if version array slot was empty *)
IF ([DS.RDX])
  THEN
    RAX := SGX_VA_SLOT_OCCUPIED
    RFLAGS.CF := 1;
FI;
```

```
(* Write version to Version Array slot *)
[DS.RDX] := TMP_VER;
```

```
(* Free up EPCM Entry *)
EPCM.(DS:RCX).VALID := 0;
ERROR_EXIT:
```

### Flags Affected

ZF is set if page is not blocked, not tracked, or a child is present. Otherwise cleared.

CF is set if VA slot is previously occupied, Otherwise cleared.

### Protected Mode Exceptions

#GP(0)	<ul style="list-style-type: none"> <li>If a memory operand effective address is outside the DS segment limit.</li> <li>If a memory operand is not properly aligned.</li> <li>If the EPC page and VASLOT resolve to the same EPC page.</li> <li>If another Intel SGX instruction is concurrently accessing either the target EPC, VA, or SECS pages.</li> <li>If the tracking resource is in use.</li> <li>If the EPC page or the version array page is invalid.</li> <li>If the parameters fail consistency checks.</li> </ul>
#PF(error code)	<ul style="list-style-type: none"> <li>If a page fault occurs in accessing memory operands.</li> <li>If a memory operand is not an EPC page.</li> <li>If one of the EPC memory operands has incorrect page type.</li> </ul>

### 64-Bit Mode Exceptions

#GP(0)	<ul style="list-style-type: none"> <li>If a memory operand is non-canonical form.</li> <li>If a memory operand is not properly aligned.</li> <li>If the EPC page and VASLOT resolve to the same EPC page.</li> <li>If another Intel SGX instruction is concurrently accessing either the target EPC, VA, or SECS pages.</li> <li>If the tracking resource is in use.</li> <li>If the EPC page or the version array page in invalid.</li> <li>If the parameters fail consistency checks.</li> </ul>
#PF(error code)	<ul style="list-style-type: none"> <li>If a page fault occurs in accessing memory operands.</li> <li>If a memory operand is not an EPC page.</li> <li>If one of the EPC memory operands has incorrect page type.</li> </ul>

## 14.8 INTEL® SGX USER LEAF FUNCTION REFERENCE

Leaf functions available with the ENCLU instruction mnemonic are covered in this section. In general, each instruction leaf requires EAX to specify the leaf function index and/or additional registers specifying leaf-specific input parameters. An instruction operand encoding table provides details of the implicitly-encoded register usage and associated input/output semantics.

In many cases, an input parameter specifies an effective address associated with a memory object inside or outside the EPC, the memory addressing semantics of these memory objects are also summarized in a separate table.

## EGETKEY—Retrieves a Cryptographic Key

Opcode/ Instruction	Op/En	64/32 bit Mode Support	CPUID Feature Flag	Description
EAX = 01H ENCLU[EGETKEY]	IR	V/V	SGX1	This leaf function retrieves a 128-bit cryptographic key.
EAX = 0BH ENCLU[EGETKEY256]	IR	V/V	EAX[12]	This leaf function retrieves a 256-bit cryptographic key.

### Instruction Operand Encoding

Op/En	EAX		RBX	RCX
IR	EGETKEY (In)	Return error code (Out)	Address to a KEYREQUEST (In)	Address of the OUTPUTDATA (In)

### Description

The ENCLU[EGETKEY] and ENCLU[EGETKEY256] instructions return a secret key from the processor specific key hierarchy. EGETKEY returns a 128-bit key, and EGETKEY256 returns a 256-bit key. The register RBX contains the effective address of a KEYREQUEST structure, which the instruction interprets to determine the key being requested. The Requesting Keys section below provides a description of the keys that can be requested. The RCX register contains the effective address where the key will be returned. Both the addresses in RBX & RCX should be locations inside the enclave.

EGETKEY/EGETKEY256 derives keys using a processor unique value to create a specific key based on a number of possible inputs. This instruction leaf can only be executed inside an enclave.

### EGETKEY Memory Parameter Semantics

KEYREQUEST	OUTPUTDATA
Enclave read access	Enclave write access

After validating the operands, the instruction determines which key is to be produced and performs the following actions:

- The instruction assembles the derivation data for the key based on the Table 14-31.
- Computes derived key using the derivation data and package specific value.
- Outputs the calculated key to the address in RCX.

The instruction fails with #GP(0) if the operands are not properly aligned. Successful completion of the instruction will clear RFLAGS.{ZF, CF, AF, OF, SF, PF}. The instruction returns an error code if the user tries to request a key based on an invalid CPUSVN or ISVSVN (when the user request is accepted, see the table below), requests a key for which it has not been granted the attribute to request, or requests a key that is not supported by the hardware. These checks may be performed in any order. Thus, an indication by error number of one cause (for example, invalid attribute) does not imply that there are not also other errors. Different processors may thus give different error numbers for the same Enclave. The correctness of software should not rely on the order resulting from the checks documented in this section. In such cases the ZF flag is set and the corresponding error bit (SGX\_INVALID\_SVN, SGX\_INVALID\_ATTRIBUTE, SGX\_INVALID\_KEYNAME) is set in RAX and the data at the address specified by RCX is unmodified.

### Requesting Keys

The KEYREQUEST structure (see Section 36.18.1) identifies the key to be provided. The Keyrequest.KeyName field identifies which type of key is requested. Note that Report Key and Provisioning Key are accessible by EGETKEY only.

### Deriving Keys

Key derivation is based on a combination of the enclave specific values (see Table 14-31) and a processor key. Depending on the key being requested a field may either be included by definition or the value may be included from the KeyRequest. A “yes” in Table 14-31 indicates the value for the field is included from its default location,

identified in the source row, and a “request” indicates the values for the field is included from its corresponding KeyRequest field.

**Table 14-31. Key Derivation**

	Key Name	Attributes	Owner Epoch	CPU SVN	ISV SVN	ISV PRODIG	ISVEXT PRODIG	ISVFAM ILYID	MRENCLAVE	MRSIGNER	CONFIG ID	CONFIGS VN	RAND
Source	Key Dependent Constant	Y := SECS.ATTRIBUTES and SECS.MISCSELECT and SECS.CET_ATTRIBUTES;	CR_SGX OWNER EPOCH	Y := CPUSVN Register;	R := Req.ISV SVN;	SECS.ISVID	SECS.IS VEXTPR ODID	SECS.IS VFAMIL YID	SECS.MRENCLAVE	SECS.MRSIGNER	SECS.CO NFIGID	SECS.CO NFIGSVN	Req. KEYID
		R := AttribMask & SECS.ATTRIBUTES and SECS.MISCSELECT and SECS.CET_ATTRIBUTES;		R := Req.CPU SVN;									
EINITTOKEN	Yes	Request	Yes	Request	Request	Yes	No	No	No	Yes	No	No	Request
Report	Yes	Yes	Yes	Yes	No	No	No	No	Yes	No	Yes	Yes	Request
Seal	Yes	Request	Yes	Request	Request	Request	Request	Request	Request	Request	Request	Request	Request
Provisioning	Yes	Request	No	Request	Request	Yes	No	No	No	Yes	No	No	Yes
Provisioning Seal	Yes	Request	No	Request	Request	Request	Request	Request	No	Yes	Request	Request	Yes

Keys that permit the specification of a CPU or ISV's code's, or enclave configuration's SVNs have additional requirements. The caller may not request a key for an SVN beyond the current CPU, ISV or enclave configuration's SVN, respectively.

Several keys are access controlled. Access to the Provisioning Key and Provisioning Seal key requires the enclave's ATTRIBUTES.PROVISIONKEY be set. The EINITTOKEN Key requires ATTRIBUTES.EINITTOKEN\_KEY be set and SECS.MRSIGNER equal IA32\_SGXLEPUBKEYHASH.

Some keys are derived based on a hardcoded SHA384 hash of a PKCS padding constant:

```

HARDCODED_PKCS1_5_PADDING[15:0] := 0100H;
HARDCODED_PKCS1_5_PADDING[2655:16] := SignExtend330Byte(-1); // 330 bytes of 0FFH
HARDCODED_PKCS1_5_PADDING[2815:2656] := 2004000501020403650148866009060D30313000H;
HARDCODED_PKCS1_5_PADDING[2831:2816] := 0100H;
HARDCODED_PKCS1_5_PADDING[5471:2832] := SignExtend314Byte(-1); // 314 bytes of 0FFH
HARDCODED_PKCS1_5_PADDING[5631:5472] := 3004000501020403650148866009060D30413000H;
HARDCODED_PKCS1_5_PADDING[5759:5632] := 0
HARDCODED_PKCS1_5_PADDING_HASH = SHA384(HARDCODED_PKCS1_5_PADDING);
    
```

The error codes are:

**Table 14-32. EGETKEY Return Value in RAX**

Error Code (see Table 14-12)	Value	Description
No Error	0	EGETKEY successful.
SGX_INVALID_ATTRIBUTE		The KEYREQUEST contains a KEYNAME for which the enclave is not authorized.
SGX_INVALID_CPUSVN		If KEYREQUEST.CPUSVN is an unsupported platforms CPUSVN value.
SGX_INVALID_ISVSVN		If KEYREQUEST software SVN (ISVSVN or CONFIGSVN) is greater than the enclave's corresponding SVN.
SGX_INVALID_KEYNAME		If KEYREQUEST.KEYNAME is an unsupported value.

Concurrency Restrictions

**Table 14-33. Base Concurrency Restrictions of EGETKEY**

Leaf	Parameter	Base Concurrency Restrictions		
		Access	On Conflict	SGX_CONFLICT VM Exit Qualification
EGETKEY	KEYREQUEST [DS:RBX]	Concurrent		
	OUTPUTDATA [DS:RCX]	Concurrent		
EGETKEY256	KEYREQUEST [DS:RBX]	Concurrent		
	OUTPUTDATA [DS:RCX]	Concurrent		

**Table 14-34. Additional Concurrency Restrictions of EGETKEY**

Leaf	Parameter	Additional Concurrency Restrictions					
		vs. EACCEPT, EACCEPTCOPY, EMODPE, EMODPR, EMODT		vs. EADD, EEXTEND, EINIT		vs. ETRACK, ETRACKC	
		Access	On Conflict	Access	On Conflict	Access	On Conflict
EGETKEY	KEYREQUEST [DS:RBX]	Concurrent		Concurrent		Concurrent	
	OUTPUTDATA [DS:RCX]	Concurrent		Concurrent		Concurrent	
EGETKEY256	KEYREQUEST [DS:RBX]	Concurrent		Concurrent		Concurrent	
	OUTPUTDATA [DS:RCX]	Concurrent		Concurrent		Concurrent	

## Operation

## Temp Variables in EGETKEY Operational Flow

Name	Type	Size (Bits)	Description
TMP_CURRENTSECS			Address of the SECS for the currently executing enclave.
TMP_KEYCONTEXT			Temporary space for key derivation context.
TMP_INCSEALFUSES	Bool		Temporary space indicating if Seal Fuses are included in key derivation.
TMP_INCOWNEREPOCH	Bool		Temporary space indicating if OwnerEpoch is included in key derivation.
TMP_KEYCPUSVN		16 bytes	
TMP_KEYDEPENDENCIES			Temp space for key derivation.
TMP_ATTRIBUTES		16 bytes	Temp Space for the calculation of the sealable Attributes.
TMP_ISVEXTPRODID		16 bytes	Temp Space for ISVEXTPRODID.
TMP_ISVPRODID		2 bytes	Temp Space for ISVPRODID.
TMP_ISVFAMILYID		16 bytes	Temp Space for ISVFAMILYID.
TMP_CONFIGID		64 bytes	Temp Space for CONFIGID.
TMP_CONFIGSVN		2 bytes	Temp Space for CONFIGSVN.
TMP_OUTPUTKEY		32 bytes	Temp Space for the calculation of the key.
		48 bytes	Temporary space for building MRENCLAVE.
		48 bytes	Temporary space for building MRSIGNER.

(\* Make sure KEYREQUEST is properly aligned and inside the current enclave \*)

```
IF ( (DS:RBX is not 512Byte aligned) or (DS:RBX is not within CR_ELRange) )
    THEN #GP(0); FI;
```

(\* Make sure DS:RBX is an EPC address and the EPC page is valid \*)

```
IF ( (DS:RBX does not resolve to an EPC address) or (EPCM(DS:RBX).VALID = 0) )
    THEN #PF(DS:RBX); FI;
```

```
IF (EPCM(DS:RBX).BLOCKED = 1)
    THEN #PF(DS:RBX); FI;
```

(\* Check page parameters for correctness \*)

```
IF ( (EPCM(DS:RBX).PT ≠ PT_REG) or (EPCM(DS:RBX).ENCLAVESECS ≠ CR_ACTIVE_SECS) or (EPCM(DS:RBX).PENDING = 1) or
    (EPCM(DS:RBX).MODIFIED = 1) or (EPCM(DS:RBX).ENCLAVEADDRESS ≠ (DS:RBX & ~0FFFH) ) or (EPCM(DS:RBX).R = 0) )
    THEN #PF(DS:RBX);
```

FI;

(\* Make sure OUTPUTDATA is properly aligned \*)

```
IF ((RAX = 0x01) AND (DS:RCX is not 16 byte aligned)) OR
    (RAX = 0x0B) AND (DS:RCX is not 32 byte aligned))
    THEN #GP(0); FI;
```

(\* Make sure OUTPUTDATA is inside the current enclave \*)

```
IF (DS:RCX is not within CR_ELRange)
    THEN #GP(0); FI;
```



```

(* Make sure DS:RCX is an EPC address and the EPC page is valid *)
IF ( ( DS:RCX does not resolve to an EPC address) or (EPCM(DS:RCX).VALID = 0) )
    THEN #PF(DS:RCX); FI;

IF (EPCM(DS:RCX).BLOCKED = 1)
    THEN #PF(DS:RCX); FI;

(* Check page parameters for correctness *)
IF ( ( EPCM(DS:RCX).PT ≠ PT_REG) or (EPCM(DS:RCX).ENCLAVESECS ≠ CR_ACTIVE_SECS) or (EPCM(DS:RCX).PENDING = 1) or
    (EPCM(DS:RCX).MODIFIED = 1) or (EPCM(DS:RCX).ENCLAVEADDRESS ≠ (DS:RCX & ~OFFFH) ) or (EPCM(DS:RCX).W = 0) )
    THEN #PF(DS:RCX);
FI;

(* Verify RESERVED spaces in KEYREQUEST are valid *)
IF ( ( DS:RBX).RESERVED ≠ 0) or (DS:RBX.KEYPOLICY.RESERVED ≠ 0) )
    THEN #GP(0); FI;

TMP_CURRENTSECS := CR_ACTIVE_SECS;

(* Verify that CONFIGSVN & New Policy bits are not used if KSS is not enabled *)
IF ((TMP_CURRENTSECS.ATTRIBUTES.KSS == 0) AND ((DS:RBX.KEYPOLICY & 0x003C ≠ 0) OR (DS:RBX.CONFIGSVN > 0)))
    THEN #GP(0); FI;

(* Determine which enclave attributes that must be included in the key. Attributes that must always be include INIT & DEBUG *)
REQUIRED_SEALING_MASK[127:0] := 00000000 00000000 00000000 00000003H;
TMP_ATTRIBUTES := (DS:RBX.ATTRIBUTEMASK | REQUIRED_SEALING_MASK) & TMP_CURRENTSECS.ATTRIBUTES;

(* Compute MISCSELECT fields to be included *)
TMP_MISCSELECT := DS:RBX.MISCMASK & TMP_CURRENTSECS.MISCSELECT

(* Compute CET_ATTRIBUTES fields to be included *)
IF (CPUID.(EAX=12H, ECX=1):EAX[6] = 1)
    THEN TMP_CET_ATTRIBUTES := DS:RBX.CET_ATTRIBUTES_MASK & TMP_CURRENTSECS.CET_ATTRIBUTES; FI;

(* Select correct MRENCLAVE/MRSIGNER for the enclave type *)
(* EGETKEY uses legacy 256 bit values regardless of ATTRIBUTES.SH384. *)
IF ((RAX = 0x0B) AND
    (TMP_CURRENTSECS.ATTRIBUTES.SHA384 = 1)) {
    THEN
        TMP_MRENCLAVEBUF[3071:0] := TMP_CURRENTSECS.MRENCLAVE384;
        TMP_MRSIGNERBUF[3071:0] := TMP_CURRENTSECS.MRSIGNER384;
    ELSE
        THEN
            TMP_MRENCLAVEBUF[2047:0] := TMP_CURRENTSECS.MRENCLAVE;
            TMP_MRENCLAVEBUF[3071:2048] := 0;
            TMP_MRSIGNERBUF[2047:0] := TMP_CURRENTSECS.MRSIGNER;
            TMP_MRSIGNERBUF[3071:2048] := 0;
        FI;

    TMP_KEYDEPENDENCIES := 0;

    CASE (DS:RBX.KEYNAME)
        SEAL_KEY:
            IF (DS:RBX.CPUSVN is beyond current CPU configuration)

```

```
        THEN
            RFLAGS.ZF := 1;
            RAX := SGX_INVALID_CPUSVN;
            GOTO EXIT;
    FI;
    IF (DS:RBX.ISVSVN > TMP_CURRENTSECS.ISVSVN)
        THEN
            RFLAGS.ZF := 1;
            RAX := SGX_INVALID_ISVSVN;
            GOTO EXIT;
    FI;
    IF (DS:RBX.CONFIGSVN > TMP_CURRENTSECS.CONFIGSVN)
        THEN
            RFLAGS.ZF := 1;
            RAX := SGX_INVALID_ISVSVN;
            GOTO EXIT;
    FI;

    (*Include enclave identity?*)
    TMP_MRENCLAVE := 0;
    IF (DS:RBX.KEYPOLICY.MRENCLAVE = 1)
        THEN TMP_MRENCLAVE := TMP_MRENCLAVEBUF;
    FI;
    (*Include enclave author?*)
    TMP_MRSIGNER := 0;
    IF (DS:RBX.KEYPOLICY.MRSIGNER = 1)
        THEN TMP_MRSIGNER := TMP_MRSIGNERBUF;
    FI;
(* Include enclave product family ID? *)
    TMP_ISVFAMILYID := 0;
    IF (DS:RBX.KEYPOLICY.ISVFAMILYID = 1)
        THEN TMP_ISVFAMILYID := TMP_CURRENTSECS.ISVFAMILYID;
    FI;

    (* Include enclave product ID? *)
    TMP_ISVPRODID := 0;
    IF (DS:RBX.KEYPOLICY.NOISVPRODID = 0)
        TMP_ISVPRODID := TMP_CURRENTSECS.ISVPRODID;
    FI;

    (* Include enclave Config ID? *)
    TMP_CONFIGID := 0;
    TMP_CONFIGSVN := 0;
    IF (DS:RBX.KEYPOLICY.CONFIGID = 1)
        TMP_CONFIGID := TMP_CURRENTSECS.CONFIGID;
        TMP_CONFIGSVN := DS:RBX.CONFIGSVN;
    FI;

    (* Include enclave extended product ID? *)
    TMP_ISVEXTPRODID := 0;
    IF (DS:RBX.KEYPOLICY.ISVEXTPRODID = 1)
        TMP_ISVEXTPRODID := TMP_CURRENTSECS.ISVEXTPRODID;
    FI;
```

```
//Determine values key is based on
TMP_KEYCONTEXT.KEYNAME := SEAL_KEY;
TMP_KEYDEPENDENCIES.ISVFAMILYID := TMP_ISVFAMILYID;
TMP_KEYDEPENDENCIES.ISVEXTPRODID := TMP_ISVEXTPRODID;
TMP_KEYDEPENDENCIES.ISVPRODID := TMP_ISVPRODID;
TMP_KEYDEPENDENCIES.ISVSVN := DS:RBX.ISVSVN;
TMP_INCOWNEREPOCH := TRUE;
TMP_KEYDEPENDENCIES.ATTRIBUTES := TMP_ATTRIBUTES;
TMP_KEYDEPENDENCIES.ATTRIBUTESMASK := DS:RBX.ATTRIBUTESMASK;
TMP_KEYDEPENDENCIES.MRENCLAVE := TMP_MRENCLAVE;
TMP_KEYDEPENDENCIES.MRSIGNER := TMP_MRSIGNER;
TMP_KEYDEPENDENCIES.KEYID := DS:RBX.KEYID;
TMP_INCSEALKEYFUSES := TRUE;
TMP_KEYCPUSVN := DS:RBX.CPUSVN;
TMP_KEYDEPENDENCIES.PADDING := TMP_CURRENTSECS.PADDING;
TMP_KEYDEPENDENCIES.MISCSELECT := TMP_MISCSELECT;
TMP_KEYDEPENDENCIES.MISCMASK := ~DS:RBX.MISCMASK;
TMP_KEYDEPENDENCIES.KEYPOLICY := DS:RBX.KEYPOLICY;
TMP_KEYDEPENDENCIES.CONFIGID := TMP_CONFIGID;
TMP_KEYDEPENDENCIES.CONFIGSVN := TMP_CONFIGSVN;
IF CPUID.(EAX=12H, ECX=1):EAX[6] = 1
    THEN
        TMP_KEYDEPENDENCIES.CET_ATTRIBUTES := TMP_CET_ATTRIBUTES;
        TMP_KEYDEPENDENCIES.CET_ATTRIBUTES_MASK := DS:RBX.CET_ATTRIBUTES_MASK;
FI;
BREAK;
```

## REPORT\_KEY:

(\* Report Keys are only available from EGETKEY. \*)

```
IF (RAX ≠ 0x01)
    THEN
        RFLAGS.ZF := 1;
        RAX := SGX_INVALID_KEYNAME;
        Goto EXIT;
FI;
```

(\* Determine values key is based on \*)

```
TMP_KEYCONTEXT.KEYNAME := REPORT_KEY;
TMP_KEYDEPENDENCIES.ISVFAMILYID := 0;
TMP_KEYDEPENDENCIES.ISVEXTPRODID := 0;
TMP_KEYDEPENDENCIES.ISVPRODID := 0;
TMP_KEYDEPENDENCIES.ISVSVN := 0;
TMP_INCOWNEREPOCH := TRUE;
TMP_KEYDEPENDENCIES.ATTRIBUTES := TMP_CURRENTSECS.ATTRIBUTES;
TMP_KEYDEPENDENCIES.ATTRIBUTESMASK := 0;
TMP_KEYDEPENDENCIES.MRENCLAVE[2047:0] := TMP_CURRENTSECS.MRENCLAVE;
TMP_KEYDEPENDENCIES.MRENCLAVE[3071:2048] := 0;
TMP_KEYDEPENDENCIES.MRSIGNER := 0;
TMP_KEYDEPENDENCIES.KEYID := DS:RBX.KEYID;
TMP_INCSEALKEYFUSES := TRUE;
TMP_KEYCPUSVN := CR_CPUSVN;
TMP_KEYDEPENDENCIES.PADDING := HARDCODED_PKCS1_5_PADDING_HASH;
TMP_KEYDEPENDENCIES.MISCSELECT := TMP_CURRENTSECS.MISCSELECT;
TMP_KEYDEPENDENCIES.MISCMASK := 0;
```

```

TMP_KEYDEPENDENCIES.KEYPOLICY := 0;
TMP_KEYDEPENDENCIES.CONFIGID := TMP_CURRENTSECS.CONFIGID;
TMP_KEYDEPENDENCIES.CONFIGSVN := TMP_CURRENTSECS.CONFIGSVN;
IF (CPUID.(EAX=12H, ECX=1):EAX[6] = 1)
    THEN
        TMP_KEYDEPENDENCIES.CET_ATTRIBUTES := TMP_CURRENTSECS.CET_ATTRIBUTES;
        TMP_KEYDEPENDENCIES.CET_ATTRIBUTES_MASK := 0;
FI;
BREAK;

```

#### EINITTOKEN\_KEY:

```

(* Check ENCLAVE has EINITTOKEN Key capability *)
IF (TMP_CURRENTSECS.ATTRIBUTES.EINITTOKEN_KEY = 0)
    THEN
        RFLAGS.ZF := 1;
        RAX := SGX_INVALID_ATTRIBUTE;
        GOTO EXIT;
FI;
IF (DS:RBX.CPUSVN is beyond current CPU configuration)
    THEN
        RFLAGS.ZF := 1;
        RAX := SGX_INVALID_CPUSVN;
        GOTO EXIT;
FI;
IF (DS:RBX.ISVSVN > TMP_CURRENTSECS.ISVSVN)
    THEN
        RFLAGS.ZF := 1;
        RAX := SGX_INVALID_ISVSVN;
        GOTO EXIT;
FI;
(* Determine values key is based on *)
TMP_KEYCONTEXT.KEYNAME := EINITTOKEN_KEY;
TMP_KEYDEPENDENCIES.ISVFAMILYID := 0;
TMP_KEYDEPENDENCIES.ISVEXTPRODID := 0;
TMP_KEYDEPENDENCIES.ISVPRODID := TMP_CURRENTSECS.ISVPRODID;
TMP_KEYDEPENDENCIES.ISVSVN := DS:RBX.ISVSVN;
TMP_INCOWNEREPOCH := TRUE;
TMP_KEYDEPENDENCIES.ATTRIBUTES := TMP_ATTRIBUTES;
TMP_KEYDEPENDENCIES.ATTRIBUTESMASK := 0;
TMP_KEYDEPENDENCIES.MRENCLAVE := 0;
TMP_KEYDEPENDENCIES.MRSIGNER := TMP_CURRENTSECS.MRSIGNER;
TMP_KEYDEPENDENCIES.KEYID := DS:RBX.KEYID;
TMP_INCSEALKEYFUSES := TRUE;
TMP_KEYCPUSVN := DS:RBX.CPUSVN;
TMP_KEYDEPENDENCIES.PADDING := TMP_CURRENTSECS.PADDING;
TMP_KEYDEPENDENCIES.MISCSELECT := TMP_MISCSELECT;
TMP_KEYDEPENDENCIES.MISCMASK := 0;
TMP_KEYDEPENDENCIES.KEYPOLICY := 0;
TMP_KEYDEPENDENCIES.CONFIGID := 0;
TMP_KEYDEPENDENCIES.CONFIGSVN := 0;
IF (CPUID.(EAX=12H, ECX=1):EAX[6] = 1)
    THEN
        TMP_KEYDEPENDENCIES.CET_ATTRIBUTES := TMP_CET_ATTRIBUTES;
        TMP_KEYDEPENDENCIES.CET_ATTRIBUTES_MASK := 0;

```

```

FI;
BREAK;

```

```

PROVISION_KEY:

```

```

(* Report Keys are only available from EGETKEY. *)

```

```

IF (RAX ≠ 0x01)

```

```

THEN

```

```

    RFLAGS.ZF := 1;
    RAX := SGX_INVALID_KEYNAME;
    Goto EXIT;

```

```

FI;

```

```

(* Check ENCLAVE has PROVISIONING capability *)

```

```

IF (TMP_CURRENTSECS.ATTRIBUTES.PROVISIONKEY = 0)

```

```

    THEN

```

```

        RFLAGS.ZF := 1;
        RAX := SGX_INVALID_ATTRIBUTE;
        GOTO EXIT;

```

```

FI;

```

```

IF (DS:RBX.CPUSVN is beyond current CPU configuration)

```

```

    THEN

```

```

        RFLAGS.ZF := 1;
        RAX := SGX_INVALID_CPUSVN;
        GOTO EXIT;

```

```

FI;

```

```

IF (DS:RBX.ISVSVN > TMP_CURRENTSECS.ISVSVN)

```

```

    THEN

```

```

        RFLAGS.ZF := 1;
        RAX := SGX_INVALID_ISVSVN;
        GOTO EXIT;

```

```

FI;

```

```

(* Determine values key is based on *)

```

```

TMP_KEYCONTEXT.KEYNAME := PROVISION_KEY;
TMP_KEYDEPENDENCIES.ISVFAMILYID := 0;
TMP_KEYDEPENDENCIES.ISVEXTPRODID := 0;
TMP_KEYDEPENDENCIES.ISVPRODID := TMP_CURRENTSECS.ISVPRODID;
TMP_KEYDEPENDENCIES.ISVSVN := DS:RBX.ISVSVN;
TMP_INCOWNEREPOCH := FALSE;
TMP_KEYDEPENDENCIES.ATTRIBUTES := TMP_ATTRIBUTES;
TMP_KEYDEPENDENCIES.ATTRIBUTESMASK := DS:RBX.ATTRIBUTESMASK;
TMP_KEYDEPENDENCIES.MRENCLAVE := 0;
TMP_KEYDEPENDENCIES.MRSIGNER := TMP_MRSIGNERBUF;
TMP_KEYDEPENDENCIES.KEYID := 0;
TMP_INCSEALKEYFUSES := FALSE;
TMP_KEYCPUSVN := DS:RBX.CPUSVN;
TMP_KEYDEPENDENCIES.PADDING := TMP_CURRENTSECS.PADDING;
TMP_KEYDEPENDENCIES.MISCSELECT := TMP_MISCSELECT;
TMP_KEYDEPENDENCIES.MISCMASK := ~DS:RBX.MISCMASK;
TMP_KEYDEPENDENCIES.KEYPOLICY := 0;
TMP_KEYDEPENDENCIES.CONFIGID := 0;
IF (CPUID.(EAX=12H, ECX=1):EAX[6] = 1)

```

```

    THEN

```

```

        TMP_KEYDEPENDENCIES.CET_ATTRIBUTES := TMP_CET_ATTRIBUTES;
        TMP_KEYDEPENDENCIES.CET_ATTRIBUTES_MASK := 0;

```

```
FI;
BREAK;

PROVISION_SEAL_KEY:
(* Check ENCLAVE has PROVISIONING capability *)
IF (TMP_CURRENTSECS.ATTRIBUTES.PROVISIONKEY = 0)
    THEN
        RFLAGS.ZF := 1;
        RAX := SGX_INVALID_ATTRIBUTE;
        GOTO EXIT;
FI;
IF (DS:RBX.CPUSVN is beyond current CPU configuration)
    THEN
        RFLAGS.ZF := 1;
        RAX := SGX_INVALID_CPUSVN;
        GOTO EXIT;
FI;
IF (DS:RBX.ISVSVN > TMP_CURRENTSECS.ISVSVN)
    THEN
        RFLAGS.ZF := 1;
        RAX := SGX_INVALID_ISVSVN;
        GOTO EXIT;
FI;
(* Include enclave product family ID? *)
TMP_ISVFAMILYID := 0;
IF (DS:RBX.KEYPOLICY.ISVFAMILYID = 1)
    THEN TMP_ISVFAMILYID := TMP_CURRENTSECS.ISVFAMILYID;
FI;

(* Include enclave product ID? *)
TMP_ISVPRODID := 0;
IF (DS:RBX.KEYPOLICY.NOISVPRODID = 0)
    THEN TMP_ISVPRODID := TMP_CURRENTSECS.ISVPRODID;
FI;

(* Include enclave Config ID? *)
TMP_CONFIGID := 0;
TMP_CONFIGSVN := 0;
IF (DS:RBX.KEYPOLICY.CONFIGID = 1)
    THEN TMP_CONFIGID := TMP_CURRENTSECS.CONFIGID;
    THEN TMP_CONFIGSVN := DS:RBX.CONFIGSVN;
FI;

(* Include enclave extended product ID? *)
TMP_ISVEXTPRODID := 0;
IF (DS:RBX.KEYPOLICY.ISVEXTPRODID = 1)
    THEN TMP_ISVEXTPRODID := TMP_CURRENTSECS.ISVEXTPRODID;
FI;

(* Determine values key is based on *)
TMP_KEYCONTEXT.KEYNAME := PROVISION_SEAL_KEY;
TMP_KEYDEPENDENCIES.ISVFAMILYID := TMP_ISVFAMILYID;
TMP_KEYDEPENDENCIES.ISVEXTPRODID := TMP_ISVEXTPRODID;
TMP_KEYDEPENDENCIES.ISVPRODID := TMP_ISVPRODID;
```

```

    TMP_KEYDEPENDENCIES.ISVSVN := DS:RBX.ISVSVN;
    TMP_INCOWNEREPOCH := FALSE;
    TMP_KEYDEPENDENCIES.ATTRIBUTES := TMP_ATTRIBUTES;
    TMP_KEYDEPENDENCIES.ATTRIBUTESMASK := DS:RBX.ATTRIBUTESMASK;
    TMP_KEYDEPENDENCIES.MRENCLAVE := 0;
    TMP_KEYDEPENDENCIES.MRSIGNER := TMP_CURRENTSECS.MRSIGNER;
    TMP_KEYDEPENDENCIES.KEYID := 0;
    TMP_INCSEALKEYFUSES := TRUE;
    TMP_KEYCPUSVN := DS:RBX.CPUSVN;
    TMP_KEYDEPENDENCIES.PADDING := TMP_CURRENTSECS.PADDING;
    TMP_KEYDEPENDENCIES.MISCSELECT := TMP_MISCSELECT;
    TMP_KEYDEPENDENCIES.MISCMASK := ~DS:RBX.MISCMASK;
    TMP_KEYDEPENDENCIES.KEYPOLICY := DS:RBX.KEYPOLICY;
    TMP_KEYDEPENDENCIES.CONFIGID := TMP_CONFIGID;
    TMP_KEYDEPENDENCIES.CONFIGSVN := TMP_CONFIGSVN;
    IF (CPUID.(EAX=12H, ECX=1):EAX[6] = 1)
        THEN
            TMP_KEYDEPENDENCIES.CET_ATTRIBUTES := TMP_CET_ATTRIBUTES;
            TMP_KEYDEPENDENCIES.CET_ATTRIBUTES_MASK := 0;
    FI;
    BREAK;
DEFAULT:
    (* The value of KEYNAME is invalid *)
    RFLAGS.ZF := 1;
    RAX := SGX_INVALID_KEYNAME;
    GOTO EXIT;
ESAC;

(* Calculate the final derived key and output to the address in RCX *)
IF (RAX == 0x01)
    THEN
        TMP_OUTPUTKEY = derivekey(TMP_KEYCPUSVN,
            TMP_INCSEALFUSES,
            TMP_INCOWNEREPOCH,
            SHA384(TMP_KEYDEPENDENCIES),
            TMP_KEY_CONTEXT,
            128);
        DS:RCX[127:0] = TMP_OUTPUTKEY;
    ELSE
        THEN
            TMP_OUTPUTKEY = derivekey(TMP_KEYCPUSVN,
                TMP_INCSEALFUSES,
                TMP_INCOWNEREPOCH,
                SHA384(TMP_KEYDEPENDENCIES),
                TMP_KEY_CONTEXT,
                256);
            DS:RCX[255:0] = TMP_OUTPUTKEY;
    }

RAX := 0;
RFLAGS.ZF := 0;

EXIT:
RFLAGS.CF := 0;

```

```
RFLAGS.PF := 0;  
RFLAGS.AF := 0;  
RFLAGS.OF := 0;  
RFLAGS.SF := 0;
```

### Flags Affected

ZF is cleared if successful, otherwise ZF is set. CF, PF, AF, OF, SF are cleared.

### Protected Mode Exceptions

#GP(0)	If executed outside an enclave. If a memory operand effective address is outside the current enclave. If an effective address is not properly aligned. If an effective address is outside the DS segment limit. If KEYREQUEST format is invalid.
#PF(error code)	If a page fault occurs in accessing memory.

### 64-Bit Mode Exceptions

#GP(0)	If executed outside an enclave. If a memory operand effective address is outside the current enclave. If an effective address is not properly aligned. If an effective address is not canonical. If KEYREQUEST format is invalid.
#PF(error code)	If a page fault occurs in accessing memory operands.



## EREPORT—Create a Cryptographic Report of the Enclave

Opcode/ Instruction	Op/En	64/32 bit Mode Support	CPUID Feature Flag	Description
EAX = 00H ENCLU[EREPORT]	IR	V/V	SGX1	This leaf function creates a cryptographic report of the enclave.

### Instruction Operand Encoding

Op/En	EAX	RBX	RCX	RDX
IR	EREPORT (In)	Address of TARGETINFO (In)	Address of REPORTDATA (In)	Address where the REPORT is written to in an OUTPUTDATA (In)

### Description

This leaf function creates a cryptographic REPORT that describes the contents of the enclave. This instruction leaf can only be executed when inside the enclave. The cryptographic report can be used by other enclaves to determine that the enclave is running on the same platform.

RBX contains the effective address of the MRENCLAVE value of the enclave that will authenticate the REPORT output, using the REPORT key delivered by EGETKEY command for that enclave. RCX contains the effective address of a 64-byte REPORTDATA structure, which allows the caller of the instruction to associate data with the enclave from which the instruction is called. RDX contains the address where the REPORT will be output by the instruction.

### EREPORT Memory Parameter Semantics

TARGETINFO	REPORTDATA	OUTPUTDATA
Read access by Enclave	Read access by Enclave	Read/Write access by Enclave

This instruction leaf perform the following:

1. Validate the 3 operands (RBX, RCX, RDX) are inside the enclave.
2. Compute a report key for the target enclave, as indicated by the value located in RBX(TARGETINFO).
3. Assemble the enclave SECS data to complete the REPORT structure (including the data provided using the RCX (REPORTDATA) operand).
4. Computes a cryptographic hash over REPORT structure.
5. Add the computed hash to the REPORT structure.
6. Output the completed REPORT structure to the address in RDX (OUTPUTDATA).

The instruction fails if the operands are not properly aligned.

CR\_REPORT\_KEYID, used to provide key wearout protection, is populated with a statistically unique value on boot of the platform by a trusted entity within the SGX TCB.

The instruction faults if any of the following:

### EREPORT Faulting Conditions

An effective address not properly aligned.	An memory address does not resolve in an EPC page.
If accessing an invalid EPC page.	If the EPC page is blocked.
May page fault.	

## Concurrency Restrictions

**Table 14-35. Base Concurrency Restrictions of EREPORT**

Leaf	Parameter	Base Concurrency Restrictions		
		Access	On Conflict	SGX_CONFLICT VM Exit Qualification
EREPORT	TARGETINFO [DS:RBX]	Concurrent		
	REPORTDATA [DS:RCX]	Concurrent		
	OUTPUTDATA [DS:RDX]	Concurrent		

**Table 14-36. Additional Concurrency Restrictions of EREPORT**

Leaf	Parameter	Additional Concurrency Restrictions					
		vs. EACCEPT, EACCEPTCOPY, EMODPE, EMODPR, EMODT		vs. EADD, EEXTEND, EINIT		vs. ETRACK, ETRACKC	
		Access	On Conflict	Access	On Conflict	Access	On Conflict
EREPORT	TARGETINFO [DS:RBX]	Concurrent		Concurrent		Concurrent	
	REPORTDATA [DS:RCX]	Concurrent		Concurrent		Concurrent	
	OUTPUTDATA [DS:RDX]	Concurrent		Concurrent		Concurrent	

## Operation

**Temp Variables in EREPORT Operational Flow**

Name	Type	Size (bits)	Description
TMP_ATTRIBUTES		32	Physical address of SECS of the enclave to which source operand belongs.
TMP_CURRENTSECS			Address of the SECS for the currently executing enclave.
TMP_KEYDEPENDENCIES			Temporary space for key derivation.
TMP_KEYCONTEXT			Temporary space for key derivation context.
TMP_REPORTKEY		128	REPORTKEY generated by the instruction.
TMP_REPORT		3712	

```
TMP_MODE64 := ((IA32_EFER.LMA = 1) && (CS.L = 1));
```

```
(* Address verification for TARGETINFO (RBX) *)
```

```
IF ( (DS:RBX is not 512Byte Aligned) or (DS:RBX is not within CR_ELRANGE) )
    THEN #GP(0); FI;
```

```
IF (DS:RBX does not resolve within an EPC)
    THEN #PF(DS:RBX); FI;
```

```
IF (EPCM(DS:RBX).VALID = 0)
    THEN #PF(DS:RBX); FI;
```

```
IF (EPCM(DS:RBX).BLOCKED = 1)
    THEN #PF(DS:RBX); FI;
```

```
(* Check page parameters for correctness *)
```

```
IF ( (EPCM(DS:RBX).PT ≠ PT_REG) or (EPCM(DS:RBX).ENCLAVESECS ≠ CR_ACTIVE_SECS) or (EPCM(DS:RBX).PENDING = 1) or
    (EPCM(DS:RBX).MODIFIED = 1) or (EPCM(DS:RBX).ENCLAVEADDRESS ≠ (DS:RBX & ~OFFFH) ) or (EPCM(DS:RBX).R = 0) )
    THEN #PF(DS:RBX);
```

```
FI;
```

```
(* Verify RESERVED spaces in TARGETINFO are valid *)
```

```
IF (DS:RBX.RESERVED != 0)
    THEN #GP(0); FI;
```

```
(* Address verification for REPORTDATA (RCX) *)
```

```
IF ( (DS:RCX is not 128Byte Aligned) or (DS:RCX is not within CR_ELRANGE) )
    THEN #GP(0); FI;
```

```
IF (DS:RCX does not resolve within an EPC)
```

```
    THEN #PF(DS:RCX); FI;
```

```
IF (EPCM(DS:RCX).VALID = 0)
```

```
    THEN #PF(DS:RCX); FI;
```

```
IF (EPCM(DS:RCX).BLOCKED = 1)
```

```
    THEN #PF(DS:RCX); FI;
```

```
(* Check page parameters for correctness *)
```

```
IF ( (EPCM(DS:RCX).PT ≠ PT_REG) or (EPCM(DS:RCX).ENCLAVESECS ≠ CR_ACTIVE_SECS) or (EPCM(DS:RCX).PENDING = 1) or
    (EPCM(DS:RCX).MODIFIED = 1) or (EPCM(DS:RCX).ENCLAVEADDRESS ≠ (DS:RCX & ~OFFFH) ) or (EPCM(DS:RCX).R = 0) )
    THEN #PF(DS:RCX);
```

```
FI;
```

```
(* Address verification for OUTPUTDATA (RDX) *)
```

```
IF ( (DS:RDX is not 512Byte Aligned) or (DS:RDX is not within CR_ELRANGE) )
    THEN #GP(0); FI;
```

```
IF (DS:RDX does not resolve within an EPC)
```

```
    THEN #PF(DS:RDX); FI;
```

```
IF (EPCM(DS:RDX).VALID = 0)
```

```
    THEN #PF(DS:RDX); FI;
```

```
IF (EPCM(DS:RDX).BLOCKED = 1)
```

```
    THEN #PF(DS:RDX); FI;
```

```
(* Check page parameters for correctness *)
```

```
IF ( (EPCM(DS:RDX).PT ≠ PT_REG) or (EPCM(DS:RDX).ENCLAVESECS ≠ CR_ACTIVE_SECS) or (EPCM(DS:RDX).PENDING = 1) or
    (EPCM(DS:RDX).MODIFIED = 1) or (EPCM(DS:RDX).ENCLAVEADDRESS ≠ (DS:RDX & ~OFFFH) ) or (EPCM(DS:RDX).W = 0) )
    THEN #PF(DS:RDX);
```

```
FI;
```

```
(* REPORT MAC needs to be computed over data which cannot be modified *)
```

```
TMP_REPORT.CPUSVN := CR_CPUSVN;
TMP_REPORT.ISVFAMILYID := TMP_CURRENTSECS.ISVFAMILYID;
TMP_REPORT.ISVEXTPRODID := TMP_CURRENTSECS.ISVEXTPRODID;
TMP_REPORT.ISVPRODID := TMP_CURRENTSECS.ISVPRODID;
TMP_REPORT.ISVSVN := TMP_CURRENTSECS.ISVSVN;
TMP_REPORT.ATTRIBUTES := TMP_CURRENTSECS.ATTRIBUTES;
```

```

TMP_REPORT.REPORTDATA := DS:RCX[511:0];
TMP_REPORT.MRENCLAVE := TMP_CURRENTSECS.MRENCLAVE;
TMP_REPORT.MRSIGNER := TMP_CURRENTSECS.MRSIGNER;
TMP_REPORT.MRRESERVED := 0;
TMP_REPORT.KEYID[255:0] := CR_REPORT_KEYID;
TMP_REPORT.MISCSELECT := TMP_CURRENTSECS.MISCSELECT;
TMP_REPORT.CONFIGID := TMP_CURRENTSECS.CONFIGID;
TMP_REPORT.CONFIGSVN := TMP_CURRENTSECS.CONFIGSVN;
IF (CPUID.(EAX=12H, ECX=1):EAX[6] = 1)
    THEN TMP_REPORT.CET_ATTRIBUTES := TMP_CURRENTSECS.CET_ATTRIBUTES; FI;

```

(\* Derive the report key \*)

```

TMP_KEYCONTEXT.KEYNAME := REPORT_KEY;
TMP_KEYDEPENDENCIES.ISVFAMILYID := 0;
TMP_KEYDEPENDENCIES.ISVEXTPRODID := 0;
TMP_KEYDEPENDENCIES.ISVPRODID := 0;
TMP_KEYDEPENDENCIES.ISVSVN := 0;
TMP_INCOWNEREPOCH := TRUE;
TMP_KEYDEPENDENCIES.ATTRIBUTES := DS:RBX.ATTRIBUTES;
TMP_KEYDEPENDENCIES.ATTRIBUTESMASK := 0;
TMP_KEYDEPENDENCIES.MRENCLAVE[2047:0] := DS:RBX.MEASUREMENT;
TMP_KEYDEPENDENCIES.MRENCLAVE[3071:2048] := 0;
TMP_KEYDEPENDENCIES.MRSIGNER := 0;
TMP_KEYDEPENDENCIES.KEYID := TMP_REPORT.KEYID;
TMP_INCSEALKEYFUSES := TRUE;
TMP_KEYCPUSVN := CR_CPUSVN;
TMP_KEYDEPENDENCIES.PADDING := TMP_CURRENTSECS.PADDING;
TMP_KEYDEPENDENCIES.MISCSELECT := DS:RBX.MISCSELECT;
TMP_KEYDEPENDENCIES.MISCMASK := 0;
TMP_KEYDEPENDENCIES.KEYPOLICY := 0;
TMP_KEYDEPENDENCIES.CONFIGID := DS:RBX.CONFIGID;
TMP_KEYDEPENDENCIES.CONFIGSVN := DS:RBX.CONFIGSVN;
IF (CPUID.(EAX=12H, ECX=1):EAX[6] = 1)
    THEN
        TMP_KEYDEPENDENCIES.CET_ATTRIBUTES := DS:RBX.CET_ATTRIBUTES;
        TMP_KEYDEPENDENCIES.CET_ATTRIBUTES_MASK := 0;
FI;

```

(\* Calculate the derived key\*)

```

TMP_REPORTKEY = derivekey(CR_CPUSVN,
    TRUE, // Include Seal Fuses
    TRUE, // Include Owner Epoch
    SHA384(TMP_KEYDEPENDENCIES),
    TMP_KEYCONTEXT,
    128);

```

(\* Call cryptographic CMAC function, CMAC data are not including MAC&KEYID \*)

```

TMP_REPORT.MAC := cmac(TMP_REPORTKEY, TMP_REPORT[3071:0] );
DS:RDX[3455:0] := TMP_REPORT;

```

### Flags Affected

None

**Protected Mode Exceptions**

#GP(0)	If executed outside an enclave. If the address in RCS is outside the DS segment limit. If a memory operand is not properly aligned. If a memory operand is not in the current enclave.
#PF(error code)	If a page fault occurs in accessing memory operands.

**64-Bit Mode Exceptions**

#GP(0)	If executed outside an enclave. If RCX is non-canonical form. If a memory operand is not properly aligned. If a memory operand is not in the current enclave.
#PF(error code)	If a page fault occurs in accessing memory operands.

## EReport2—Create a Cryptographic Report of the Enclave

Opcode/ Instruction	Op/En	64/32 bit Mode Support	CPUID Feature Flag	Description
EAX = 0AH ENCLU[EReport2]	IR	V/V	EAX[12]	This leaf function creates a cryptographic REPORT2 of the enclave.

### Instruction Operand Encoding

Op/En	EAX	RBX	RCX	RDX
IR	EReport2 (In)	Address of REPORTDATA (In)	Address where the REPORT2 is written to in an OUTPUTDATA (In)	REPORT2 Subtype

### Description

This instruction creates a cryptographic REPORT2 structure that describes the contents of the enclave. The instruction can only be executed when inside the enclave. The cryptographic report can be used by other enclaves to determine whether the enclave is running on the same platform.

RBX contains the effective address of a REPORTDATA structure, which allows the caller of the instruction to associate data with the enclave from which the instruction is called. RCX contains the address where the REPORT2 structure will be output by the instruction.

Compared to a REPORT created by ENCLU[EReport], REPORT2 structures can be verified by any enclave using ENCLU[EVERIFYREPORT2] instruction, whereas REPORT structures can only be verified by the enclave whose TARGETINFO was provided at EREPORT invocation. REPORT2 can reflect SHA384 measurements, whereas REPORT only supports legacy SHA256 measurement.

### EReport2 Memory Parameter Semantics

REPORTDATA	OUTPUTDATA
Read access by Enclave	Read/Write access by Enclave

This instruction leaf performs the following:

1. Validate the operands (RBX, RCX) are inside the enclave.
2. Assemble the enclave SECS values to complete the REPORT2 structure.
3. Compute hash SECS values.
4. Assemble REPORTMACSTRUCT fields (including the data provided using the RBX [REPORTDATA] operand).
5. Computes a 256-bit HMAC over REPORTMACSTRUCT structure using CR\_REPORT\_MAC\_KEY.
6. Output the completed REPORT2 structure to the address in RCX (OUTPUTDATA).

The instruction fails if the operands are not properly aligned.

The instruction faults if any of the following occur:

### EReport2 Faulting Conditions

An effective address not properly aligned.	A memory address does not resolve in an EPC page.
If accessing an invalid EPC page.	If the EPC page is blocked.
May page fault.	

Concurrency Restrictions

**Table 14-37. Base Concurrency Restrictions of EREPORT2**

Leaf	Parameter	Base Concurrency Restrictions		
		Access	On Conflict	SGX_CONFLICT VM Exit Qualification
EREPORT2	REPORTDATA [DS:RBX]	Concurrent		
	OUTPUTDATA [DS:RCX]	Concurrent		

**Table 14-38. Additional Concurrency Restrictions of EREPORT2**

Leaf	Parameter	Additional Concurrency Restrictions					
		vs. EACCEPT, EACCEPTCOPY, EMODPE, EMODPR, EMODT		vs. EADD, EEXTEND, EINIT		vs. ETRACK, ETRACKC	
		Access	On Conflict	Access	On Conflict	Access	On Conflict
EREPORT2	REPORTDATA [DS:RBX]	Concurrent		Concurrent		Concurrent	
	OUTPUTDATA [DS:RCX]	Concurrent		Concurrent		Concurrent	

Operation

**Temp Variables in EREPORT2 Operational Flow**

Name	Type	Size (bits)	Description
TMP_CURRENTSECS			Address of the SECS for the currently executing enclave.
TMP_REPORTKEY		32 bytes	256-bit REPORT2 key generated by instruction.
TMP_REPORT2	REPORT2	768 bytes	
TMP_DERIVATIONSTRING		192 bytes	Derivation string for REPORT2 key.
TMP_CURRENTSECS			Address of the SECS for the currently executing enclave.

**EREPORT2 Return Value in RAX**

Error	Value	Description
No error	0	EREPORT2 successful.
SGX_INVALID_REPORT_SUBTYPE		Invalid REPORT subtype was specified.

(\* Address verification for REPORTDATA (RBX) \*)  
 IF((DS:RBX is not 64 Byte aligned) or (DS:RBX is not within CR\_ELRange))  
 THEN #GP(0); FI;

IF (DS:RBX does not resolve within an EPC)  
 THEN #PF(DS:RBX); FI;

IF (EPCM(DS:RBX).VALID = 0)  
 THEN #PF(DS:RBX); FI;

IF (EPCM(DS:RBX).BLOCKED = 1)

```
THEN #PF(DS:RBX); FI;
```

```
(* Check page parameters for correctness *)
```

```
IF ( (EPCM(DS:RBX).PT ≠ PT_REG) or (EPCM(DS:RBX).ENCLAVESECS ≠ CR_ACTIVE_SECS) or (EPCM(DS:RBX).PENDING = 1) or
    (EPCM(DS:RBX).MODIFIED = 1) or (EPCM(DS:RBX).ENCLAVEADDRESS ≠ (DS:RBX & ~OFFFH) ) or (EPCM(DS:RBX).R = 0) )
    THEN #PF(DS:RBX);
```

```
FI;
```

```
(* Address verification for OUTPUTDATA (RCX) *)
```

```
IF((DS:RCX is not 1024 Byte aligned) or (DS:RCX is not within CR_ELRange))
    THEN #GP(0); FI;
```

```
IF (DS:RCX does not resolve within an EPC)
```

```
    THEN #PF(DS:RCX); FI;
```

```
IF (EPCM(DS:RCX).VALID = 0)
```

```
    THEN #PF(DS:RCX); FI;
```

```
IF (EPCM(DS:RCX).BLOCKED = 1)
```

```
    THEN #PF(DS:RCX); FI;
```

```
(* Check page parameters for correctness *)
```

```
IF ( (EPCM(DS:RCX).PT ≠ PT_REG) or (EPCM(DS:RCX).ENCLAVESECS ≠ CR_ACTIVE_SECS) or (EPCM(DS:RCX).PENDING = 1) or
    (EPCM(DS:RCX).MODIFIED = 1) or (EPCM(DS:RCX).ENCLAVEADDRESS ≠ (DS:RCX & ~OFFFH) ) or (EPCM(DS:RCX).W = 0) )
    THEN #PF(DS:RCX);
```

```
FI;
```

```
(* Verify subtype is valid *)
```

```
IF(RDX != 0)
```

```
    THEN
```

```
        RAX := SGX_INVALID_REPORT_SUBTYPE;
```

```
        RFLAGS.ZF := 1;
```

```
        GOTO EXIT;
```

```
FI;
```

```
TMP_CURRENTSECS := CR_ACTIVE_SECS;
```

```
(* REPORT MAC needs to be computed over data which cannot be modified *)
```

```
TMP_REPORT2.TEEINFO.MISCSELECT := TMP_CURRENTSECS.MISCSELECT;
```

```
TMP_REPORT2.TEEINFO.ISVPRODID := TMP_CURRENTSECS.ISVPRODID;
```

```
TMP_REPORT2.TEEINFO.ISVSVN := TMP_CURRENTSECS.ISVSVN;
```

```
TMP_REPORT2.TEEINFO.CONFIGSVN := TMP_CURRENTSECS.CONFIGSVN;
```

```
TMP_REPORT2.TEEINFO.ISVEXTPRODID := TMP_CURRENTSECS.ISVEXTPRODID;
```

```
TMP_REPORT2.TEEINFO.ATTRIBUTES := TMP_CURRENTSECS.ATTRIBUTES;
```

```
TMP_REPORT2.TEEINFO.MRENCLAVE := TMP_CURRENTSECS.MRENCLAVE;
```

```
TMP_REPORT2.TEEINFO.MRSIGNER := TMP_CURRENTSECS.MRSIGNER;
```

```
TMP_REPORT2.TEEINFO.CONFIGID := TMP_CURRENTSECS.CONFIGID;
```

```
TMP_REPORT2.TEEINFO.ISVFAMILYID := TMP_CURRENTSECS.ISVFAMILYID;
```

```
IF(TMP_CURRENTSECS.ATTRIBUTES.SHA384 == 1)
```

```
    THEN
```

```
        TMP_REPORT2.TEEINFO.MRENCLAVE384 := TMP_CURRENTSECS.MRENCLAVE384;
```

```
        TMP_REPORT2.TEEINFO.MRSIGNER384 := TMP_CURRENTSECS.MRSIGNER384;
```

```
FI;
```



```

TMP_REPORT2.REPORTMACSTRUCT.TYPE := 0x00;
TMP_REPORT2.REPORTMACSTRUCT.SUBTYPE := 0x00;
TMP_REPORT2.REPORTMACSTRUCT.VERSION := 0x00;
TMP_REPORT2.REPORTMACSTRUCT.CPUSVN := CR_CPUSVN
TMP_REPORT2.REPORTMACSTRUCT.TEEINFOHASH := SHA384(TMP_REPORT2.TEEINFO);
TMP_REPORT2.REPORTMACSTRUCT.REPORTDATA := DS:RBX[511:0];

```

(\* compute HMAC for REPORTMACSTRUCT \*)

```

TMP_REPORT2.REPORTMACSTRUCT.MAC := HMAC-SHA256(CR_REPORT_MAC_KEY, TMP_REPORT2.REPORTMACSTRUCT[1535:0]);

```

```

DS:RCX[6143:0] := TMP_REPORT2;

```

```

RAX := 0;

```

```

RFLAGS.ZF := 0;

```

EXIT:

```

RFLAGS.CF := 0;

```

```

RFLAGS.PF := 0;

```

```

RFLAGS.AF := 0;

```

```

RFLAGS.OF := 0;

```

```

RFLAGS.SF := 0;

```

#### Flags Affected

ZF	Cleared if instruction completed successfully. Set if error occurred. RAX is set to the error code.
CF, PF, AF, OF, SF	Cleared.

#### Protected Mode Exceptions

#GP(0)	If executed outside an enclave. If a memory operand effective address is outside the DS segment limit. If DS segment is unusable. If a memory operand is not properly aligned.
#PF(error code)	If a page fault occurs in accessing memory operands, including EPCM-induced faults.

#### 64-Bit Mode Exceptions

#GP(0)	If executed outside an enclave. If memory address is in a non-canonical form. If a memory operand is not properly aligned.
#PF(error code)	If a page fault occurs in accessing memory operands, including EPCM-induced faults.

