

# Intel® 64 and IA-32 Architectures Software Developer's Manual

## Volume 2A: Instruction Set Reference, A-L

**NOTE:** The *Intel® 64 and IA-32 Architectures Software Developer's Manual* consists of ten volumes: *Basic Architecture*, Order Number 253665; *Instruction Set Reference A-L*, Order Number 253666; *Instruction Set Reference M-U*, Order Number 253667; *Instruction Set Reference V-Z*, Order Number 326018; *Instruction Set Reference*, Order Number 334569; *System Programming Guide, Part 1*, Order Number 253668; *System Programming Guide, Part 2*, Order Number 253669; *System Programming Guide, Part 3*, Order Number 326019; *System Programming Guide, Part 4*, Order Number 332831; *Model-Specific Registers*, Order Number 335592. Refer to all ten volumes when evaluating your design needs.

Order Number: 253666-065US  
December 2017

Intel technologies features and benefits depend on system configuration and may require enabled hardware, software, or service activation. Learn more at [intel.com](http://intel.com), or from the OEM or retailer.

No computer system can be absolutely secure. Intel does not assume any liability for lost or stolen data or systems or any damages resulting from such losses.

You may not use or facilitate the use of this document in connection with any infringement or other legal analysis concerning Intel products described herein. You agree to grant Intel a non-exclusive, royalty-free license to any patent claim thereafter drafted which includes subject matter disclosed herein.

No license (express or implied, by estoppel or otherwise) to any intellectual property rights is granted by this document.

The products described may contain design defects or errors known as errata which may cause the product to deviate from published specifications. Current characterized errata are available on request.

This document contains information on products, services and/or processes in development. All information provided here is subject to change without notice. Contact your Intel representative to obtain the latest Intel product specifications and roadmaps

Copies of documents which have an order number and are referenced in this document, or other Intel literature, may be obtained by calling 1-800-548-4725, or by visiting <http://www.intel.com/design/literature.htm>.

Intel, the Intel logo, Intel Atom, Intel Core, Intel SpeedStep, MMX, Pentium, VTune, and Xeon are trademarks of Intel Corporation in the U.S. and/or other countries.

\*Other names and brands may be claimed as the property of others.

## CHAPTER 1

### ABOUT THIS MANUAL

1.1	INTEL <sup>®</sup> 64 AND IA-32 PROCESSORS COVERED IN THIS MANUAL	1-1
1.2	OVERVIEW OF VOLUME 2A, 2B, 2C AND 2D: INSTRUCTION SET REFERENCE	1-4
1.3	NOTATIONAL CONVENTIONS	1-4
1.3.1	Bit and Byte Order	1-4
1.3.2	Reserved Bits and Software Compatibility	1-5
1.3.3	Instruction Operands	1-5
1.3.4	Hexadecimal and Binary Numbers	1-6
1.3.5	Segmented Addressing	1-6
1.3.6	Exceptions	1-6
1.3.7	A New Syntax for CPUID, CR, and MSR Values	1-6
1.4	RELATED LITERATURE	1-7

## CHAPTER 2

### INSTRUCTION FORMAT

2.1	INSTRUCTION FORMAT FOR PROTECTED MODE, REAL-ADDRESS MODE, AND VIRTUAL-8086 MODE	2-1
2.1.1	Instruction Prefixes	2-1
2.1.2	Opcodes	2-3
2.1.3	ModR/M and SIB Bytes	2-3
2.1.4	Displacement and Immediate Bytes	2-3
2.1.5	Addressing-Mode Encoding of ModR/M and SIB Bytes	2-4
2.2	IA-32E MODE	2-7
2.2.1	REX Prefixes	2-8
2.2.1.1	Encoding	2-8
2.2.1.2	More on REX Prefix Fields	2-8
2.2.1.3	Displacement	2-11
2.2.1.4	Direct Memory-Offset MOVs	2-11
2.2.1.5	Immediates	2-11
2.2.1.6	RIP-Relative Addressing	2-12
2.2.1.7	Default 64-Bit Operand Size	2-12
2.2.2	Additional Encodings for Control and Debug Registers	2-12
2.3	INTEL <sup>®</sup> ADVANCED VECTOR EXTENSIONS (INTEL <sup>®</sup> AVX)	2-13
2.3.1	Instruction Format	2-13
2.3.2	VEX and the LOCK prefix	2-13
2.3.3	VEX and the 66H, F2H, and F3H prefixes	2-13
2.3.4	VEX and the REX prefix	2-13
2.3.5	The VEX Prefix	2-14
2.3.5.1	VEX Byte 0, bits[7:0]	2-15
2.3.5.2	VEX Byte 1, bit [7] - 'R'	2-15
2.3.5.3	3-byte VEX byte 1, bit[6] - 'X'	2-16
2.3.5.4	3-byte VEX byte 1, bit[5] - 'B'	2-16
2.3.5.5	3-byte VEX byte 2, bit[7] - 'W'	2-16
2.3.5.6	2-byte VEX Byte 1, bits[6:3] and 3-byte VEX Byte 2, bits [6:3]- 'vvvv' the Source or Dest Register Specifier	2-16
2.3.6	Instruction Operand Encoding and VEX.vvvv, ModR/M	2-17
2.3.6.1	3-byte VEX byte 1, bits[4:0] - "m-mmmm"	2-18
2.3.6.2	2-byte VEX byte 1, bit[2], and 3-byte VEX byte 2, bit [2]- "L"	2-18
2.3.6.3	2-byte VEX byte 1, bits[1:0], and 3-byte VEX byte 2, bits [1:0]- "pp"	2-18
2.3.7	The Opcode Byte	2-19
2.3.8	The MODRM, SIB, and Displacement Bytes	2-19
2.3.9	The Third Source Operand (Immediate Byte)	2-19
2.3.10	AVX Instructions and the Upper 128-bits of YMM registers	2-19
2.3.10.1	Vector Length Transition and Programming Considerations	2-19

2.3.11	AVX Instruction Length	2-20
2.3.12	Vector SIB (VSIB) Memory Addressing	2-20
2.3.12.1	64-bit Mode VSIB Memory Addressing	2-21
2.4	AVX AND SSE INSTRUCTION EXCEPTION SPECIFICATION	2-21
2.4.1	Exceptions Type 1 (Aligned memory reference)	2-26
2.4.2	Exceptions Type 2 ( $\geq 16$ Byte Memory Reference, Unaligned)	2-27
2.4.3	Exceptions Type 3 ( $< 16$ Byte memory argument)	2-28
2.4.4	Exceptions Type 4 ( $\geq 16$ Byte mem arg no alignment, no floating-point exceptions)	2-29
2.4.5	Exceptions Type 5 ( $< 16$ Byte mem arg and no FP exceptions)	2-30
2.4.6	Exceptions Type 6 (VEX-Encoded Instructions Without Legacy SSE Analogues)	2-31
2.4.7	Exceptions Type 7 (No FP exceptions, no memory arg)	2-32
2.4.8	Exceptions Type 8 (AVX and no memory argument)	2-32
2.4.9	Exception Type 11 (VEX-only, mem arg no AC, floating-point exceptions)	2-33
2.4.10	Exception Type 12 (VEX-only, VSIB mem arg, no AC, no floating-point exceptions)	2-34
2.5	VEX ENCODING SUPPORT FOR GPR INSTRUCTIONS	2-34
2.5.1	Exception Conditions for VEX-Encoded GPR Instructions	2-35
2.6	INTEL® AVX-512 ENCODING	2-35
2.6.1	Instruction Format and EVEX	2-36
2.6.2	Register Specifier Encoding and EVEX	2-38
2.6.3	Opmask Register Encoding	2-38
2.6.4	Masking Support in EVEX	2-39
2.6.5	Compressed Displacement ( $\text{disp8} * N$ ) Support in EVEX	2-39
2.6.6	EVEX Encoding of Broadcast/Rounding/SAE Support	2-41
2.6.7	Embedded Broadcast Support in EVEX	2-41
2.6.8	Static Rounding Support in EVEX	2-41
2.6.9	SAE Support in EVEX	2-41
2.6.10	Vector Length Orthogonality	2-41
2.6.11	#UD Equations for EVEX	2-42
2.6.11.1	State Dependent #UD	2-42
2.6.11.2	Opcode Independent #UD	2-42
2.6.11.3	Opcode Dependent #UD	2-43
2.6.12	Device Not Available	2-44
2.6.13	Scalar Instructions	2-44
2.7	EXCEPTION CLASSIFICATIONS OF EVEX-ENCODED INSTRUCTIONS	2-44
2.7.1	Exceptions Type E1 and E1NF of EVEX-Encoded Instructions	2-48
2.7.2	Exceptions Type E2 of EVEX-Encoded Instructions	2-50
2.7.3	Exceptions Type E3 and E3NF of EVEX-Encoded Instructions	2-51
2.7.4	Exceptions Type E4 and E4NF of EVEX-Encoded Instructions	2-53
2.7.5	Exceptions Type E5 and E5NF	2-55
2.7.6	Exceptions Type E6 and E6NF	2-57
2.7.7	Exceptions Type E7NM	2-59
2.7.8	Exceptions Type E9 and E9NF	2-60
2.7.9	Exceptions Type E10	2-62
2.7.10	Exception Type E11 (EVEX-only, mem arg no AC, floating-point exceptions)	2-64
2.7.11	Exception Type E12 and E12NP (VSIB mem arg, no AC, no floating-point exceptions)	2-65
2.8	EXCEPTION CLASSIFICATIONS OF OPMASK INSTRUCTIONS	2-67

## CHAPTER 3

### INSTRUCTION SET REFERENCE, A-L

3.1	INTERPRETING THE INSTRUCTION REFERENCE PAGES	3-1
3.1.1	Instruction Format	3-1
3.1.1.1	Opcode Column in the Instruction Summary Table (Instructions without VEX Prefix)	3-2
3.1.1.2	Opcode Column in the Instruction Summary Table (Instructions with VEX prefix)	3-3
3.1.1.3	Instruction Column in the Opcode Summary Table	3-5
3.1.1.4	Operand Encoding Column in the Instruction Summary Table	3-8
3.1.1.5	64/32-bit Mode Column in the Instruction Summary Table	3-8
3.1.1.6	CPUID Support Column in the Instruction Summary Table	3-10
3.1.1.7	Description Column in the Instruction Summary Table	3-10
3.1.1.8	Description Section	3-10

3.1.1.9	Operation Section .....	3-10
3.1.1.10	Intel® C/C++ Compiler Intrinsic Equivalents Section .....	3-13
3.1.1.11	Flags Affected Section .....	3-15
3.1.1.12	FPU Flags Affected Section .....	3-15
3.1.1.13	Protected Mode Exceptions Section .....	3-15
3.1.1.14	Real-Address Mode Exceptions Section .....	3-16
3.1.1.15	Virtual-8086 Mode Exceptions Section .....	3-16
3.1.1.16	Floating-Point Exceptions Section .....	3-17
3.1.1.17	SIMD Floating-Point Exceptions Section .....	3-17
3.1.1.18	Compatibility Mode Exceptions Section .....	3-17
3.1.1.19	64-Bit Mode Exceptions Section .....	3-17
3.2	INSTRUCTIONS (A-L) .....	3-18
	AAA—ASCII Adjust After Addition .....	3-19
	AAD—ASCII Adjust AX Before Division .....	3-21
	AAM—ASCII Adjust AX After Multiply .....	3-23
	AAS—ASCII Adjust AL After Subtraction .....	3-25
	ADC—Add with Carry .....	3-27
	ADCX — Unsigned Integer Addition of Two Operands with Carry Flag .....	3-30
	ADD—Add .....	3-32
	ADDPD—Add Packed Double-Precision Floating-Point Values .....	3-34
	ADDPS—Add Packed Single-Precision Floating-Point Values .....	3-37
	ADDSD—Add Scalar Double-Precision Floating-Point Values .....	3-40
	ADDSS—Add Scalar Single-Precision Floating-Point Values .....	3-42
	ADDSUBPD—Packed Double-FP Add/Subtract .....	3-44
	ADDSUBPS—Packed Single-FP Add/Subtract .....	3-46
	ADOX — Unsigned Integer Addition of Two Operands with Overflow Flag .....	3-49
	AESDEC—Perform One Round of an AES Decryption Flow .....	3-51
	AESDECLAST—Perform Last Round of an AES Decryption Flow .....	3-53
	AESENC—Perform One Round of an AES Encryption Flow .....	3-55
	AESENCLAST—Perform Last Round of an AES Encryption Flow .....	3-57
	AESIMC—Perform the AES InvMixColumn Transformation .....	3-59
	AESKEYGENASSIST—AES Round Key Generation Assist .....	3-60
	AND—Logical AND .....	3-62
	ANDN — Logical AND NOT .....	3-64
	ANDPD—Bitwise Logical AND of Packed Double Precision Floating-Point Values .....	3-65
	ANDPS—Bitwise Logical AND of Packed Single Precision Floating-Point Values .....	3-68
	ANDNPD—Bitwise Logical AND NOT of Packed Double Precision Floating-Point Values .....	3-71
	ANDNPS—Bitwise Logical AND NOT of Packed Single Precision Floating-Point Values .....	3-74
	ARPL—Adjust RPL Field of Segment Selector .....	3-77
	BLENDDPD — Blend Packed Double Precision Floating-Point Values .....	3-79
	BEXTR — Bit Field Extract .....	3-81
	BLENDPS — Blend Packed Single Precision Floating-Point Values .....	3-82
	BLENDVPD — Variable Blend Packed Double Precision Floating-Point Values .....	3-84
	BLENDVPS — Variable Blend Packed Single Precision Floating-Point Values .....	3-86
	BLSI — Extract Lowest Set Isolated Bit .....	3-89
	BLSMSK — Get Mask Up to Lowest Set Bit .....	3-90
	BLSR — Reset Lowest Set Bit .....	3-91
	BNDCL—Check Lower Bound .....	3-92
	BNDU/BNDCN—Check Upper Bound .....	3-94
	BNDLDX—Load Extended Bounds Using Address Translation .....	3-96
	BNDMK—Make Bounds .....	3-99
	BNDMOV—Move Bounds .....	3-101
	BNDSTX—Store Extended Bounds Using Address Translation .....	3-104
	BOUND—Check Array Index Against Bounds .....	3-107
	BSF—Bit Scan Forward .....	3-109
	BSR—Bit Scan Reverse .....	3-111
	BSWAP—Byte Swap .....	3-113
	BT—Bit Test .....	3-114
	BTC—Bit Test and Complement .....	3-116

BTR—Bit Test and Reset .....	3-118
BTS—Bit Test and Set .....	3-120
BZHI — Zero High Bits Starting with Specified Bit Position .....	3-122
CALL—Call Procedure .....	3-123
CBW/CWDE/CDQE—Convert Byte to Word/Convert Word to Doubleword/Convert Doubleword to Quadword .....	3-136
CLAC—Clear AC Flag in EFLAGS Register .....	3-137
CLC—Clear Carry Flag .....	3-138
CLD—Clear Direction Flag .....	3-139
CLFLUSH—Flush Cache Line .....	3-140
CLFLUSHOPT—Flush Cache Line Optimized .....	3-142
CLI — Clear Interrupt Flag .....	3-144
CLTS—Clear Task-Switched Flag in CR0 .....	3-146
CLWB—Cache Line Write Back .....	3-147
CMC—Complement Carry Flag .....	3-149
CMOVcc—Conditional Move .....	3-150
CMP—Compare Two Operands .....	3-154
CMPPD—Compare Packed Double-Precision Floating-Point Values .....	3-156
CMPPS—Compare Packed Single-Precision Floating-Point Values .....	3-163
CMPS/CMPSB/CMPSW/CMPSD/CMPSQ—Compare String Operands .....	3-170
CMPSD—Compare Scalar Double-Precision Floating-Point Value .....	3-174
CMPSS—Compare Scalar Single-Precision Floating-Point Value .....	3-178
CMPXCHG—Compare and Exchange .....	3-182
CMPXCHG8B/CMPXCHG16B—Compare and Exchange Bytes .....	3-184
COMISD—Compare Scalar Ordered Double-Precision Floating-Point Values and Set EFLAGS .....	3-187
COMISS—Compare Scalar Ordered Single-Precision Floating-Point Values and Set EFLAGS .....	3-189
CPUID—CPU Identification .....	3-191
CRC32 — Accumulate CRC32 Value .....	3-228
CVTDQ2PD—Convert Packed Doubleword Integers to Packed Double-Precision Floating-Point Values .....	3-231
CVTDQ2PS—Convert Packed Doubleword Integers to Packed Single-Precision Floating-Point Values .....	3-235
CVTPD2DQ—Convert Packed Double-Precision Floating-Point Values to Packed Doubleword Integers .....	3-238
CVTPD2PI—Convert Packed Double-Precision FP Values to Packed Dword Integers .....	3-242
CVTPD2PS—Convert Packed Double-Precision Floating-Point Values to Packed Single-Precision Floating-Point Values .....	3-243
CVTPI2PD—Convert Packed Dword Integers to Packed Double-Precision FP Values .....	3-247
CVTPI2PS—Convert Packed Dword Integers to Packed Single-Precision FP Values .....	3-248
CVTPS2DQ—Convert Packed Single-Precision Floating-Point Values to Packed Signed Doubleword Integer Values .....	3-249
CVTPS2PD—Convert Packed Single-Precision Floating-Point Values to Packed Double-Precision Floating-Point Values .....	3-252
CVTPS2PI—Convert Packed Single-Precision FP Values to Packed Dword Integers .....	3-255
CVTSD2SI—Convert Scalar Double-Precision Floating-Point Value to Doubleword Integer .....	3-256
CVTSD2SS—Convert Scalar Double-Precision Floating-Point Value to Scalar Single-Precision Floating-Point Value .....	3-258
CVTSI2SD—Convert Doubleword Integer to Scalar Double-Precision Floating-Point Value .....	3-260
CVTSI2SS—Convert Doubleword Integer to Scalar Single-Precision Floating-Point Value .....	3-262
CVTSS2SD—Convert Scalar Single-Precision Floating-Point Value to Scalar Double-Precision Floating-Point Value .....	3-264
CVTSS2SI—Convert Scalar Single-Precision Floating-Point Value to Doubleword Integer .....	3-266
CVTTPD2DQ—Convert with Truncation Packed Double-Precision Floating-Point Values to Packed Doubleword Integers .....	3-268
CVTTPD2PI—Convert with Truncation Packed Double-Precision FP Values to Packed Dword Integers .....	3-272
CVTTPS2DQ—Convert with Truncation Packed Single-Precision Floating-Point Values to Packed Signed Doubleword Integer Values .....	3-273
CVTTPS2PI—Convert with Truncation Packed Single-Precision FP Values to Packed Dword Integers .....	3-276
CVTTSD2SI—Convert with Truncation Scalar Double-Precision Floating-Point Value to Signed Integer .....	3-277
CVTTSS2SI—Convert with Truncation Scalar Single-Precision Floating-Point Value to Integer .....	3-279
CWD/CDQ/CQO—Convert Word to Doubleword/Convert Doubleword to Quadword .....	3-281
DAA—Decimal Adjust AL after Addition .....	3-282
DAS—Decimal Adjust AL after Subtraction .....	3-284
DEC—Decrement by 1 .....	3-286
DIV—Unsigned Divide .....	3-288
DIVPD—Divide Packed Double-Precision Floating-Point Values .....	3-291

DIVPS—Divide Packed Single-Precision Floating-Point Values	3-294
DIVSD—Divide Scalar Double-Precision Floating-Point Value	3-297
DIVSS—Divide Scalar Single-Precision Floating-Point Values	3-299
DPPD — Dot Product of Packed Double Precision Floating-Point Values	3-301
DPPS — Dot Product of Packed Single Precision Floating-Point Values	3-303
EMMS—Empty MMX Technology State	3-306
ENTER—Make Stack Frame for Procedure Parameters	3-307
EXTRACTPS—Extract Packed Floating-Point Values	3-310
F2XM1—Compute 2x-1	3-312
FABS—Absolute Value	3-314
FADD/FADDP/FIADD—Add	3-315
FBLD—Load Binary Coded Decimal	3-318
FBSTP—Store BCD Integer and Pop	3-320
FCBS—Change Sign	3-322
FCLEX/FNCLEX—Clear Exceptions	3-324
FCMOVcc—Floating-Point Conditional Move	3-326
FCOM/FCOMP/FCOMPP—Compare Floating Point Values	3-328
FCOMI/FCOMIP/ FUCOMI/FUCOMIP—Compare Floating Point Values and Set EFLAGS	3-331
FCOS— Cosine	3-334
FDECSTP—Decrement Stack-Top Pointer	3-336
FDIV/FDIVP/FIDIV—Divide	3-337
FDIVR/FDIVRP/FIDIVR—Reverse Divide	3-340
FFREE—Free Floating-Point Register	3-343
FICOM/FICOMP—Compare Integer	3-344
FILD—Load Integer	3-346
FINCSTP—Increment Stack-Top Pointer	3-348
FINIT/FNINIT—Initialize Floating-Point Unit	3-349
FIST/FISTP—Store Integer	3-351
FISTTP—Store Integer with Truncation	3-354
FLD—Load Floating Point Value	3-356
FLD1/FLDL2T/FLDL2E/FLDPI/FLDLG2/FLDLN2/FLDZ—Load Constant	3-358
FLDCW—Load x87 FPU Control Word	3-360
FLDENV—Load x87 FPU Environment	3-362
FMUL/FMULP/FIMUL—Multiply	3-364
FNOP—No Operation	3-367
FPATAN—Partial Arctangent	3-368
FPREM—Partial Remainder	3-370
FPREM1—Partial Remainder	3-372
FPTAN—Partial Tangent	3-374
FRNDINT—Round to Integer	3-376
FRSTOR—Restore x87 FPU State	3-377
FSAVE/FNSAVE—Store x87 FPU State	3-379
FSCALE—Scale	3-382
FSIN—Sine	3-384
FSINCOS—Sine and Cosine	3-386
FSQRT—Square Root	3-388
FST/FSTP—Store Floating Point Value	3-390
FSTCW/FNSTCW—Store x87 FPU Control Word	3-392
FSTENV/FNSTENV—Store x87 FPU Environment	3-394
FSTSW/FNSTSW—Store x87 FPU Status Word	3-396
FSUB/FSUBP/FISUB—Subtract	3-398
FSUBR/FSUBRP/FISUBR—Reverse Subtract	3-401
FTST—TEST	3-404
FUCOM/FUCOMP/FUCOMPP—Unordered Compare Floating Point Values	3-406
FXAM—Examine Floating-Point	3-409
FXCH—Exchange Register Contents	3-411
FXRSTOR—Restore x87 FPU, MMX, XMM, and MXCSR State	3-413
FXSAVE—Save x87 FPU, MMX Technology, and SSE State	3-416
FXTRACT—Extract Exponent and Significand	3-424

FYL2X—Compute $y * \log_2 x$ .....	3-426
FYL2XP1—Compute $y * \log_2(x + 1)$ .....	3-428
HADDPD—Packed Double-FP Horizontal Add .....	3-430
HADDPS—Packed Single-FP Horizontal Add .....	3-433
HLT—Halt .....	3-436
HSUBPD—Packed Double-FP Horizontal Subtract .....	3-437
HSUBPS—Packed Single-FP Horizontal Subtract .....	3-440
IDIV—Signed Divide .....	3-443
IMUL—Signed Multiply .....	3-446
IN—Input from Port .....	3-450
INC—Increment by 1 .....	3-452
INS/INSB/INSW/INSD—Input from Port to String .....	3-454
INSERTPS—Insert Scalar Single-Precision Floating-Point Value .....	3-457
INT n/INTO/INT 3—Call to Interrupt Procedure .....	3-460
INVD—Invalidate Internal Caches .....	3-473
INVLPG—Invalidate TLB Entries .....	3-475
INVPID—Invalidate Process-Context Identifier .....	3-477
IRET/IRETD—Interrupt Return .....	3-480
Jcc—Jump if Condition Is Met .....	3-487
JMP—Jump .....	3-492
KADDw/KADDB/KADDQ/KADDD—ADD Two Masks .....	3-500
KANDw/KANDB/KANDQ/KANDD—Bitwise Logical AND Masks .....	3-501
KANDNw/KANDNB/KANDNQ/KANDND—Bitwise Logical AND NOT Masks .....	3-502
KMOVw/KMOVB/KMOVQ/KMOVD—Move from and to Mask Registers .....	3-503
KNOTw/KNOTB/KNOTQ/KNOTD—NOT Mask Register .....	3-505
KORw/KORB/KORQ/KORD—Bitwise Logical OR Masks .....	3-506
KORTESTw/KORTESTB/KORTESTQ/KORTESTD—OR Masks And Set Flags .....	3-507
KSHIFTLw/KSHIFTLB/KSHIFTLQ/KSHIFTLd—Shift Left Mask Registers .....	3-509
KSHIFTRw/KSHIFTRB/KSHIFTRQ/KSHIFTRd—Shift Right Mask Registers .....	3-511
KTESTw/KTESTB/KTESTQ/KTESTD—Packed Bit Test Masks and Set Flags .....	3-513
KUNPCKBw/KUNPCKwD/KUNPCKDQ—Unpack for Mask Registers .....	3-515
KXNORw/KXNORB/KXNORQ/KXNORD—Bitwise Logical XNOR Masks .....	3-516
KXORw/KXORB/KXORQ/KXORD—Bitwise Logical XOR Masks .....	3-517
LAHF—Load Status Flags into AH Register .....	3-518
LAR—Load Access Rights Byte .....	3-519
LDDQU—Load Unaligned Integer 128 Bits .....	3-522
LDMXCSR—Load MXCSR Register .....	3-524
LDS/LES/LFS/LGS/LSS—Load Far Pointer .....	3-525
LEA—Load Effective Address .....	3-529
LEAVE—High Level Procedure Exit .....	3-531
LFENCE—Load Fence .....	3-533
LGDT/LIDT—Load Global/Interrupt Descriptor Table Register .....	3-534
LLDT—Load Local Descriptor Table Register .....	3-537
LMSW—Load Machine Status Word .....	3-539
LOCK—Assert LOCK# Signal Prefix .....	3-541
LODS/LODSB/LODSw/LODSD/LODSQ—Load String .....	3-543
LOOP/LOOPcc—Loop According to ECX Counter .....	3-546
LSL—Load Segment Limit .....	3-548
LTR—Load Task Register .....	3-551
LZCNT— Count the Number of Leading Zero Bits .....	3-553

**CHAPTER 4**

**INSTRUCTION SET REFERENCE, M-U**

4.1	IMM8 CONTROL BYTE OPERATION FOR PCMPSTRI / PCMPSTRM / PCMPISTRI / PCMPISTRM .....	4-1
4.1.1	General Description .....	4-1
4.1.2	Source Data Format .....	4-2
4.1.3	Aggregation Operation .....	4-2
4.1.4	Polarity .....	4-3
4.1.5	Output Selection .....	4-4



	PAGE	
4.1.6	Valid/Invalid Override of Comparisons .....	4-4
4.1.7	Summary of Im8 Control byte .....	4-5
4.1.8	Diagram Comparison and Aggregation Process .....	4-6
4.2	COMMON TRANSFORMATION AND PRIMITIVE FUNCTIONS FOR SHA1XXX AND SHA256XXX .....	4-6
4.3	INSTRUCTIONS (M-U) .....	4-7
	MASKMOVDQU—Store Selected Bytes of Double Quadword .....	4-8
	MASKMOVQ—Store Selected Bytes of Quadword .....	4-10
	MAXPD—Maximum of Packed Double-Precision Floating-Point Values .....	4-12
	MAXPS—Maximum of Packed Single-Precision Floating-Point Values .....	4-15
	MAXSD—Return Maximum Scalar Double-Precision Floating-Point Value .....	4-18
	MAXSS—Return Maximum Scalar Single-Precision Floating-Point Value .....	4-20
	MFENCE—Memory Fence .....	4-22
	MINPD—Minimum of Packed Double-Precision Floating-Point Values .....	4-23
	MINPS—Minimum of Packed Single-Precision Floating-Point Values .....	4-26
	MINSD—Return Minimum Scalar Double-Precision Floating-Point Value .....	4-29
	MINSS—Return Minimum Scalar Single-Precision Floating-Point Value .....	4-31
	MONITOR—Set Up Monitor Address .....	4-33
	MOV—Move .....	4-35
	MOV—Move to/from Control Registers .....	4-40
	MOV—Move to/from Debug Registers .....	4-43
	MOVAPD—Move Aligned Packed Double-Precision Floating-Point Values .....	4-45
	MOVAPS—Move Aligned Packed Single-Precision Floating-Point Values .....	4-49
	MOVBE—Move Data After Swapping Bytes .....	4-53
	MOVD/MOVQ—Move Doubleword/Move Quadword .....	4-55
	MOVDDUP—Replicate Double FP Values .....	4-59
	MOVDDQA, VMOVDDQA32/64—Move Aligned Packed Integer Values .....	4-62
	MOVDDQU, VMOVDDQU8/16/32/64—Move Unaligned Packed Integer Values .....	4-67
	MOVDDQ2Q—Move Quadword from XMM to MMX Technology .....	4-75
	MOVHLPD—Move Packed Single-Precision Floating-Point Values High to Low .....	4-76
	MOVHPD—Move High Packed Double-Precision Floating-Point Value .....	4-78
	MOVHPS—Move High Packed Single-Precision Floating-Point Values .....	4-80
	MOVLHPS—Move Packed Single-Precision Floating-Point Values Low to High .....	4-82
	MOVLPD—Move Low Packed Double-Precision Floating-Point Value .....	4-84
	MOVLPS—Move Low Packed Single-Precision Floating-Point Values .....	4-86
	MOVMSKPD—Extract Packed Double-Precision Floating-Point Sign Mask .....	4-88
	MOVMSKPS—Extract Packed Single-Precision Floating-Point Sign Mask .....	4-90
	MOVNTDQA—Load Double Quadword Non-Temporal Aligned Hint .....	4-92
	MOVNTDQ—Store Packed Integers Using Non-Temporal Hint .....	4-94
	MOVNTI—Store Doubleword Using Non-Temporal Hint .....	4-96
	MOVNTPD—Store Packed Double-Precision Floating-Point Values Using Non-Temporal Hint .....	4-98
	MOVNTPS—Store Packed Single-Precision Floating-Point Values Using Non-Temporal Hint .....	4-100
	MOVNTQ—Store of Quadword Using Non-Temporal Hint .....	4-102
	MOVQ—Move Quadword .....	4-103
	MOVQ2DQ—Move Quadword from MMX Technology to XMM Register .....	4-106
	MOVSB/MOVSB/MOVSW/MOVSD/MOVSQ—Move Data from String to String .....	4-107
	MOVSD—Move or Merge Scalar Double-Precision Floating-Point Value .....	4-111
	MOVSHDUP—Replicate Single FP Values .....	4-114
	MOVSLDUP—Replicate Single FP Values .....	4-117
	MOVSS—Move or Merge Scalar Single-Precision Floating-Point Value .....	4-120
	MOVSBX/MOVSDX—Move with Sign-Extension .....	4-124
	MOVUPD—Move Unaligned Packed Double-Precision Floating-Point Values .....	4-126
	MOVUPS—Move Unaligned Packed Single-Precision Floating-Point Values .....	4-130
	MOVZX—Move with Zero-Extend .....	4-134
	MPSADBW — Compute Multiple Packed Sums of Absolute Difference .....	4-136
	MUL—Unsigned Multiply .....	4-144
	MULPD—Multiply Packed Double-Precision Floating-Point Values .....	4-146
	MULPS—Multiply Packed Single-Precision Floating-Point Values .....	4-149
	MULSD—Multiply Scalar Double-Precision Floating-Point Value .....	4-152
	MULSS—Multiply Scalar Single-Precision Floating-Point Values .....	4-154

MULX — Unsigned Multiply Without Affecting Flags	4-156
MWAIT—Monitor Wait	4-158
NEG—Two's Complement Negation	4-161
NOP—No Operation	4-163
NOT—One's Complement Negation	4-164
OR—Logical Inclusive OR	4-166
ORPD—Bitwise Logical OR of Packed Double Precision Floating-Point Values	4-168
ORPS—Bitwise Logical OR of Packed Single Precision Floating-Point Values	4-171
OUT—Output to Port	4-174
OUTS/OUTSB/OUTSW/OUTSD—Output String to Port	4-176
PABS/PABSW/PABSD/PABSQ — Packed Absolute Value	4-180
PACKSSWB/PACKSSDW—Pack with Signed Saturation	4-186
PACKUSDW—Pack with Unsigned Saturation	4-194
PACKUSWB—Pack with Unsigned Saturation	4-199
PADDB/PADDW/PADDD/PADDQ—Add Packed Integers	4-204
PADDSB/PADDSW—Add Packed Signed Integers with Signed Saturation	4-211
PADDUSB/PADDUSW—Add Packed Unsigned Integers with Unsigned Saturation	4-215
PALIGNR — Packed Align Right	4-219
PAND—Logical AND	4-223
PANDN—Logical AND NOT	4-226
PAUSE—Spin Loop Hint	4-229
PAVGB/PAVGW—Average Packed Integers	4-230
PBLENDVB — Variable Blend Packed Bytes	4-234
PBLENDW — Blend Packed Words	4-238
PCLMULQDQ — Carry-Less Multiplication Quadword	4-241
PCMPEQB/PCMPEQW/PCMPEQD— Compare Packed Data for Equal	4-244
PCMPEQQ — Compare Packed Qword Data for Equal	4-250
PCMPSTR — Packed Compare Explicit Length Strings, Return Index	4-253
PCMPSTRM — Packed Compare Explicit Length Strings, Return Mask	4-255
PCMPGTB/PCMPGTW/PCMPGTD—Compare Packed Signed Integers for Greater Than	4-257
PCMPGTQ — Compare Packed Data for Greater Than	4-263
PCMPISTR — Packed Compare Implicit Length Strings, Return Index	4-266
PCMPISTRM — Packed Compare Implicit Length Strings, Return Mask	4-268
PDEP — Parallel Bits Deposit	4-270
PEXT — Parallel Bits Extract	4-272
PEXTRB/PEXTRD/PEXTRQ — Extract Byte/Dword/Qword	4-274
PEXTRW—Extract Word	4-277
PHADDW/PHADD — Packed Horizontal Add	4-280
PHADDSW — Packed Horizontal Add and Saturate	4-284
PHMINPOSUW — Packed Horizontal Word Minimum	4-286
PHSUBW/PHSUBD — Packed Horizontal Subtract	4-288
PHSUBSW — Packed Horizontal Subtract and Saturate	4-291
PINSRB/PINSRD/PINSRQ — Insert Byte/Dword/Qword	4-293
PINSRW—Insert Word	4-296
PMADDUSW — Multiply and Add Packed Signed and Unsigned Bytes	4-298
PMADDWD—Multiply and Add Packed Integers	4-301
PMASB/PMASW/PMASD/PMASQ—Maximum of Packed Signed Integers	4-304
PMASUB/PMASUW—Maximum of Packed Unsigned Integers	4-311
PMASUD/PMASUQ—Maximum of Packed Unsigned Integers	4-316
PMINSB/PMINSW—Minimum of Packed Signed Integers	4-320
PMINSUD/PMINSQ—Minimum of Packed Signed Integers	4-325
PMINUB/PMINUW—Minimum of Packed Unsigned Integers	4-329
PMINUD/PMINUQ—Minimum of Packed Unsigned Integers	4-334
PMOVB—Move Byte Mask	4-338
PMOVSX—Packed Move with Sign Extend	4-340
PMOVZX—Packed Move with Zero Extend	4-349
PMULDQ—Multiply Packed Doubleword Integers	4-358
PMULHSW — Packed Multiply High with Round and Scale	4-361
PMULHUW—Multiply Packed Unsigned Integers and Store High Result	4-365

PMULHW—Multiply Packed Signed Integers and Store High Result	4-369
PMULLD/PMULLQ—Multiply Packed Integers and Store Low Result	4-373
PMULLW—Multiply Packed Signed Integers and Store Low Result	4-377
PMULUDQ—Multiply Packed Unsigned Doubleword Integers	4-381
POP—Pop a Value from the Stack	4-384
POPA/POPAD—Pop All General-Purpose Registers	4-389
POPCNT — Return the Count of Number of Bits Set to 1	4-391
POPF/POPPD/POPFQ—Pop Stack into EFLAGS Register	4-393
POR—Bitwise Logical OR	4-397
PREFETCHh—Prefetch Data Into Caches	4-400
PREFETCHW—Prefetch Data into Caches in Anticipation of a Write	4-402
PSADBW—Compute Sum of Absolute Differences	4-404
PSHUFb — Packed Shuffle Bytes	4-408
PSHUFD—Shuffle Packed Doublewords	4-412
PSHUFHW—Shuffle Packed High Words	4-416
PSHUFLW—Shuffle Packed Low Words	4-419
PSHUFw—Shuffle Packed Words	4-422
PSIGNB/PSIGNW/PSIGND — Packed SIGN	4-423
PSLLDQ—Shift Double Quadword Left Logical	4-427
PSLLW/PSLLD/PSLLQ—Shift Packed Data Left Logical	4-429
PSRAW/PSRAD/PSRAQ—Shift Packed Data Right Arithmetic	4-441
PSRLDQ—Shift Double Quadword Right Logical	4-451
PSRLW/PSRLD/PSRLQ—Shift Packed Data Right Logical	4-453
PSUBB/PSUBW/PSUBD—Subtract Packed Integers	4-465
PSUBQ—Subtract Packed Quadword Integers	4-472
PSUBSB/PSUBSW—Subtract Packed Signed Integers with Signed Saturation	4-475
PSUBUSB/PSUBUSW—Subtract Packed Unsigned Integers with Unsigned Saturation	4-479
PTEST- Logical Compare	4-483
PTWRITE - Write Data to a Processor Trace Packet	4-485
PUNPCKHBW/PUNPCKHWD/PUNPCKHDQ/PUNPCKHQDQ—Unpack High Data	4-487
PUNPCKLBW/PUNPCKLWD/PUNPCKLDQ/PUNPCKLQDQ—Unpack Low Data	4-497
PUSH—Push Word, Doubleword or Quadword Onto the Stack	4-507
PUSHA/PUSHAD—Push All General-Purpose Registers	4-510
PUSHF/PUSHFD/PUSHFQ—Push EFLAGS Register onto the Stack	4-512
PXOR—Logical Exclusive OR	4-514
RCL/RCR/ROL/ROR—Rotate	4-517
RCPPS—Compute Reciprocals of Packed Single-Precision Floating-Point Values	4-522
RCPSS—Compute Reciprocal of Scalar Single-Precision Floating-Point Values	4-524
RDFSBASE/RDGSBASE—Read FS/GS Segment Base	4-526
RDMSR—Read from Model Specific Register	4-528
RDPID—Read Processor ID	4-530
RDPKRU—Read Protection Key Rights for User Pages	4-531
RDPMC—Read Performance-Monitoring Counters	4-533
RDRAND—Read Random Number	4-537
RDSEED—Read Random SEED	4-539
RDTSC—Read Time-Stamp Counter	4-541
RDTSCP—Read Time-Stamp Counter and Processor ID	4-543
REP/REPE/REPZ/REPNE/REPZ—Repeat String Operation Prefix	4-545
RET—Return from Procedure	4-549
RORX — Rotate Right Logical Without Affecting Flags	4-559
ROUNDPD — Round Packed Double Precision Floating-Point Values	4-560
ROUNDPS — Round Packed Single Precision Floating-Point Values	4-563
ROUNDSD — Round Scalar Double Precision Floating-Point Values	4-566
ROUNDSS — Round Scalar Single Precision Floating-Point Values	4-568
RSM—Resume from System Management Mode	4-570
RSQRTPS—Compute Reciprocals of Square Roots of Packed Single-Precision Floating-Point Values	4-572
RSQRTSS—Compute Reciprocal of Square Root of Scalar Single-Precision Floating-Point Value	4-574
SAHF—Store AH into Flags	4-576
SAL/SAR/SHL/SHR—Shift	4-578

SARX/SHLX/SHRX — Shift Without Affecting Flags .....4-583

SBB—Integer Subtraction with Borrow .....4-585

SCAS/SCASB/SCASW/SCASD—Scan String .....4-588

SETcc—Set Byte on Condition .....4-592

SFENCE—Store Fence .....4-595

SGDT—Store Global Descriptor Table Register .....4-596

SHA1RND4—Perform Four Rounds of SHA1 Operation .....4-598

SHA1NEXTE—Calculate SHA1 State Variable E after Four Rounds .....4-600

SHA1MSG1—Perform an Intermediate Calculation for the Next Four SHA1 Message Dwords .....4-601

SHA1MSG2—Perform a Final Calculation for the Next Four SHA1 Message Dwords .....4-602

SHA256RND2—Perform Two Rounds of SHA256 Operation .....4-603

SHA256MSG1—Perform an Intermediate Calculation for the Next Four SHA256 Message Dwords .....4-605

SHA256MSG2—Perform a Final Calculation for the Next Four SHA256 Message Dwords .....4-606

SHLD—Double Precision Shift Left .....4-607

SHRD—Double Precision Shift Right .....4-610

SHUFDP—Packed Interleave Shuffle of Pairs of Double-Precision Floating-Point Values .....4-613

SHUFPS—Packed Interleave Shuffle of Quadruplets of Single-Precision Floating-Point Values .....4-618

SIDT—Store Interrupt Descriptor Table Register .....4-622

SLDT—Store Local Descriptor Table Register .....4-624

SMSW—Store Machine Status Word .....4-626

SQRTPD—Square Root of Double-Precision Floating-Point Values .....4-628

SQRTPS—Square Root of Single-Precision Floating-Point Values .....4-631

SQRTSD—Compute Square Root of Scalar Double-Precision Floating-Point Value .....4-634

SQRTSS—Compute Square Root of Scalar Single-Precision Value .....4-636

STAC—Set AC Flag in EFLAGS Register .....4-638

STC—Set Carry Flag .....4-639

STD—Set Direction Flag .....4-640

STI—Set Interrupt Flag .....4-641

STMXCSR—Store MXCSR Register State .....4-643

STOS/STOSB/STOSW/STOSD/STOSQ—Store String .....4-644

STR—Store Task Register .....4-648

SUB—Subtract .....4-650

SUBPD—Subtract Packed Double-Precision Floating-Point Values .....4-652

SUBPS—Subtract Packed Single-Precision Floating-Point Values .....4-655

SUBSD—Subtract Scalar Double-Precision Floating-Point Value .....4-658

SUBSS—Subtract Scalar Single-Precision Floating-Point Value .....4-660

SWAPGS—Swap GS Base Register .....4-662

SYSCALL—Fast System Call .....4-664

SYSENTER—Fast System Call .....4-666

SYSEXIT—Fast Return from Fast System Call .....4-669

SYSRET—Return From Fast System Call .....4-672

TEST—Logical Compare .....4-675

TZCNT — Count the Number of Trailing Zero Bits .....4-677

UCOMISD—Unordered Compare Scalar Double-Precision Floating-Point Values and Set EFLAGS .....4-679

UCOMISS—Unordered Compare Scalar Single-Precision Floating-Point Values and Set EFLAGS .....4-681

UD—Undefined Instruction .....4-683

UNPCKHPD—Unpack and Interleave High Packed Double-Precision Floating-Point Values .....4-684

UNPCKHPS—Unpack and Interleave High Packed Single-Precision Floating-Point Values .....4-688

UNPCKLPD—Unpack and Interleave Low Packed Double-Precision Floating-Point Values .....4-692

UNPCKLPS—Unpack and Interleave Low Packed Single-Precision Floating-Point Values .....4-696

**CHAPTER 5**

**INSTRUCTION SET REFERENCE, V-Z**

5.1 TERNARY BIT VECTOR LOGIC TABLE ..... 5-1

5.2 INSTRUCTIONS (V-Z) ..... 5-4

    VALIGND/VALIGNQ—Align Doubleword/Quadword Vectors ..... 5-5

    VBLENDMPD/VBLENDMPS—Blend Float64/Float32 Vectors Using an OpMask Control ..... 5-9

    VBROADCAST—Load with Broadcast Floating-Point Data ..... 5-12

    VCOMPRESSPD—Store Sparse Packed Double-Precision Floating-Point Values into Dense Memory ..... 5-20

VCOMPRESSPS—Store Sparse Packed Single-Precision Floating-Point Values into Dense Memory . . . . .	5-22
VCVTPD2QQ—Convert Packed Double-Precision Floating-Point Values to Packed Quadword Integers . . . . .	5-24
VCVTPD2UDQ—Convert Packed Double-Precision Floating-Point Values to Packed Unsigned Doubleword Integers . . . . .	5-27
VCVTPD2UQQ—Convert Packed Double-Precision Floating-Point Values to Packed Unsigned Quadword Integers . . . . .	5-30
VCVTPH2PS—Convert 16-bit FP values to Single-Precision FP values . . . . .	5-33
VCVTPS2PH—Convert Single-Precision FP value to 16-bit FP value . . . . .	5-36
VCVTPS2UDQ—Convert Packed Single-Precision Floating-Point Values to Packed Unsigned Doubleword Integer Values . . . . .	5-40
VCVTPS2QQ—Convert Packed Single Precision Floating-Point Values to Packed Singed Quadword Integer Values . . . . .	5-43
VCVTPS2UQQ—Convert Packed Single Precision Floating-Point Values to Packed Unsigned Quadword Integer Values . . . . .	5-46
VCVTQQ2PD—Convert Packed Quadword Integers to Packed Double-Precision Floating-Point Values . . . . .	5-49
VCVTQQ2PS—Convert Packed Quadword Integers to Packed Single-Precision Floating-Point Values . . . . .	5-51
VCVTSD2USI—Convert Scalar Double-Precision Floating-Point Value to Unsigned Doubleword Integer . . . . .	5-53
VCVTSS2USI—Convert Scalar Single-Precision Floating-Point Value to Unsigned Doubleword Integer . . . . .	5-54
VCVTTPD2QQ—Convert with Truncation Packed Double-Precision Floating-Point Values to Packed Quadword Integers . . . . .	5-56
VCVTTPD2UDQ—Convert with Truncation Packed Double-Precision Floating-Point Values to Packed Unsigned Doubleword Integers . . . . .	5-58
VCVTTPD2UQQ—Convert with Truncation Packed Double-Precision Floating-Point Values to Packed Unsigned Quadword Integers . . . . .	5-61
VCVTTPS2UDQ—Convert with Truncation Packed Single-Precision Floating-Point Values to Packed Unsigned Doubleword Integer Values . . . . .	5-63
VCVTTPS2QQ—Convert with Truncation Packed Single Precision Floating-Point Values to Packed Singed Quadword Integer Values . . . . .	5-65
VCVTTPS2UQQ—Convert with Truncation Packed Single Precision Floating-Point Values to Packed Unsigned Quadword Integer Values . . . . .	5-67
VCVTSD2USI—Convert with Truncation Scalar Double-Precision Floating-Point Value to Unsigned Integer . . . . .	5-69
VCVTSS2USI—Convert with Truncation Scalar Single-Precision Floating-Point Value to Unsigned Integer . . . . .	5-70
VCVTUDQ2PD—Convert Packed Unsigned Doubleword Integers to Packed Double-Precision Floating-Point Values . . . . .	5-72
VCVTUDQ2PS—Convert Packed Unsigned Doubleword Integers to Packed Single-Precision Floating-Point Values . . . . .	5-74
VCVTUQQ2PD—Convert Packed Unsigned Quadword Integers to Packed Double-Precision Floating-Point Values . . . . .	5-76
VCVTUQQ2PS—Convert Packed Unsigned Quadword Integers to Packed Single-Precision Floating-Point Values . . . . .	5-78
VCVTUSI2SD—Convert Unsigned Integer to Scalar Double-Precision Floating-Point Value . . . . .	5-80
VCVTUSI2SS—Convert Unsigned Integer to Scalar Single-Precision Floating-Point Value . . . . .	5-82
VDBPSADBW—Double Block Packed Sum-Absolute-Differences (SAD) on Unsigned Bytes . . . . .	5-84
VEXPANDPD—Load Sparse Packed Double-Precision Floating-Point Values from Dense Memory . . . . .	5-88
VEXPANDPS—Load Sparse Packed Single-Precision Floating-Point Values from Dense Memory . . . . .	5-90
VERR/VERW—Verify a Segment for Reading or Writing . . . . .	5-92
VEXTRACTF128/VEXTRACTF32x4/VEXTRACTF64x2/VEXTRACTF32x8/VEXTRACTF64x4—Extract Packed Floating-Point Values . . . . .	5-94
VEXTRACTI128/VEXTRACTI32x4/VEXTRACTI64x2/VEXTRACTI32x8/VEXTRACTI64x4—Extract packed Integer Values . . . . .	5-100
VFIXUPIMMPD—Fix Up Special Packed Float64 Values . . . . .	5-106
VFIXUPIMMPS—Fix Up Special Packed Float32 Values . . . . .	5-110
VFIXUPIMMSD—Fix Up Special Scalar Float64 Value . . . . .	5-114
VFIXUPIMMSS—Fix Up Special Scalar Float32 Value . . . . .	5-117
VFMADD132PD/VFMADD213PD/VFMADD231PD—Fused Multiply-Add of Packed Double-Precision Floating-Point Values . . . . .	5-120
VFMADD132PS/VFMADD213PS/VFMADD231PS—Fused Multiply-Add of Packed Single-Precision Floating-Point Values . . . . .	5-127
VFMADD132SD/VFMADD213SD/VFMADD231SD—Fused Multiply-Add of Scalar Double-Precision Floating-Point Values . . . . .	5-134
VFMADD132SS/VFMADD213SS/VFMADD231SS—Fused Multiply-Add of Scalar Single-Precision Floating-Point Values . . . . .	5-137
VFMADDSUB132PD/VFMADDSUB213PD/VFMADDSUB231PD—Fused Multiply-Alternating Add/Subtract of Packed Double-Precision Floating-Point Values . . . . .	5-140
VFMADDSUB132PS/VFMADDSUB213PS/VFMADDSUB231PS—Fused Multiply-Alternating Add/Subtract of Packed Single-Precision Floating-Point Values . . . . .	5-150
VFMSUBADD132PD/VFMSUBADD213PD/VFMSUBADD231PD—Fused Multiply-Alternating Subtract/Add of Packed Double-	

Precision Floating-Point Values .....5-159

VFMSUBADD132PS/VFMSUBADD213PS/VFMSUBADD231PS—Fused Multiply-Alternating Subtract/Add of Packed Single-Precision Floating-Point Values .....5-169

VFMSUB132PD/VFMSUB213PD/VFMSUB231PD—Fused Multiply-Subtract of Packed Double-Precision Floating-Point Values .....5-179

VFMSUB132PS/VFMSUB213PS/VFMSUB231PS—Fused Multiply-Subtract of Packed Single-Precision Floating-Point Values 5-186

VFMSUB132SD/VFMSUB213SD/VFMSUB231SD—Fused Multiply-Subtract of Scalar Double-Precision Floating-Point Values 5-193

VFMSUB132SS/VFMSUB213SS/VFMSUB231SS—Fused Multiply-Subtract of Scalar Single-Precision Floating-Point Values 5-196

VFNMADD132PD/VFNMADD213PD/VFNMADD231PD—Fused Negative Multiply-Add of Packed Double-Precision Floating-Point Values .....5-199

VFNMADD132PS/VFNMADD213PS/VFNMADD231PS—Fused Negative Multiply-Add of Packed Single-Precision Floating-Point Values .....5-206

VFNMADD132SD/VFNMADD213SD/VFNMADD231SD—Fused Negative Multiply-Add of Scalar Double-Precision Floating-Point Values .....5-212

VFNMADD132SS/VFNMADD213SS/VFNMADD231SS—Fused Negative Multiply-Add of Scalar Single-Precision Floating-Point Values .....5-215

VFNMSUB132PD/VFNMSUB213PD/VFNMSUB231PD—Fused Negative Multiply-Subtract of Packed Double-Precision Floating-Point Values .....5-218

VFNMSUB132PS/VFNMSUB213PS/VFNMSUB231PS—Fused Negative Multiply-Subtract of Packed Single-Precision Floating-Point Values .....5-224

VFNMSUB132SD/VFNMSUB213SD/VFNMSUB231SD—Fused Negative Multiply-Subtract of Scalar Double-Precision Floating-Point Values .....5-230

VFNMSUB132SS/VFNMSUB213SS/VFNMSUB231SS—Fused Negative Multiply-Subtract of Scalar Single-Precision Floating-Point Values .....5-233

VFPCLASSPD—Tests Types Of a Packed Float64 Values .....5-236

VFPCLASSPS—Tests Types Of a Packed Float32 Values .....5-239

VFPCLASSSD—Tests Types Of a Scalar Float64 Values .....5-241

VFPCLASSSS—Tests Types Of a Scalar Float32 Values .....5-243

VGATHERDPD/VGATHERQPD — Gather Packed DP FP Values Using Signed Dword/Qword Indices .....5-245

VGATHERDPS/VGATHERQPS — Gather Packed SP FP values Using Signed Dword/Qword Indices .....5-250

VGATHERDPS/VGATHERDPD—Gather Packed Single, Packed Double with Signed Dword .....5-255

VGATHERQPS/VGATHERQPD—Gather Packed Single, Packed Double with Signed Qword Indices .....5-258

VGETEXPPD—Convert Exponents of Packed DP FP Values to DP FP Values .....5-261

VGETEXPPS—Convert Exponents of Packed SP FP Values to SP FP Values .....5-264

VGETEXPSD—Convert Exponents of Scalar DP FP Values to DP FP Value .....5-268

VGETEXPSS—Convert Exponents of Scalar SP FP Values to SP FP Value .....5-270

VGETMANTPD—Extract Float64 Vector of Normalized Mantissas from Float64 Vector .....5-272

VGETMANTPS—Extract Float32 Vector of Normalized Mantissas from Float32 Vector .....5-276

VGETMANTSD—Extract Float64 of Normalized Mantissas from Float64 Scalar .....5-279

VGETMANTSS—Extract Float32 Vector of Normalized Mantissa from Float32 Vector .....5-281

VINSERTF128/VINSERTF32x4/VINSERTF64x2/VINSERTF32x8/VINSERTF64x4—Insert Packed Floating-Point Values.5-283

VINSERTI128/VINSERTI32x4/VINSERTI64x2/VINSERTI32x8/VINSERTI64x4—Insert Packed Integer Values .....5-287

VMASKMOV—Conditional SIMD Packed Loads and Stores .....5-291

VPBLEND — Blend Packed Dwords .....5-294

VPBLENDMB/VPBLENDMW—Blend Byte/Word Vectors Using an Opmask Control .....5-296

VPBLENDMD/VPBLENDMQ—Blend Int32/Int64 Vectors Using an OpMask Control .....5-298

VPBROADCASTB/W/D/Q—Load with Broadcast Integer Data from General Purpose Register .....5-301

VPBROADCAST—Load Integer and Broadcast .....5-304

VPBROADCASTM—Broadcast Mask to Vector Register .....5-313

VPMPB/VPMPUB—Compare Packed Byte Values Into Mask .....5-315

VPMPD/VPMPUD—Compare Packed Integer Values into Mask .....5-318

VPMPQ/VPMPUQ—Compare Packed Integer Values into Mask .....5-321

VPMPW/VPMPUW—Compare Packed Word Values Into Mask .....5-324

VPCOMPRESSD—Store Sparse Packed Doubleword Integer Values into Dense Memory/Register .....5-327

VPCOMPRESSQ—Store Sparse Packed Quadword Integer Values into Dense Memory/Register .....5-329

VPCONFLICTD/Q—Detect Conflicts Within a Vector of Packed Dword/Qword Values into Dense Memory/ Register	5-331
VPERM2F128 — Permute Floating-Point Values	5-334
VPERM2I128 — Permute Integer Values	5-336
VPERMB—Permute Packed Bytes Elements	5-338
VPERMD/VPERMW—Permute Packed Doublewords/Words Elements	5-340
VPERMI2B—Full Permute of Bytes from Two Tables Overwriting the Index	5-343
VPERMI2W/D/Q/PS/PD—Full Permute From Two Tables Overwriting the Index	5-345
VPERMILPD—Permute In-Lane of Pairs of Double-Precision Floating-Point Values	5-351
VPERMILPS—Permute In-Lane of Quadruples of Single-Precision Floating-Point Values	5-356
VPERMPD—Permute Double-Precision Floating-Point Elements	5-361
VPERMPS—Permute Single-Precision Floating-Point Elements	5-364
VPERMQ—Qwords Element Permutation	5-367
VPERMT2B—Full Permute of Bytes from Two Tables Overwriting a Table	5-370
VPERMT2W/D/Q/PS/PD—Full Permute from Two Tables Overwriting one Table	5-372
VPEXPANDD—Load Sparse Packed Doubleword Integer Values from Dense Memory / Register	5-377
VPEXPANDQ—Load Sparse Packed Quadword Integer Values from Dense Memory / Register	5-379
VPGATHERDD/VPGATHERQD — Gather Packed Dword Values Using Signed Dword/Qword Indices	5-381
VPGATHERDD/VPGATHERDQ—Gather Packed Dword, Packed Qword with Signed Dword Indices	5-385
VPGATHERDQ/VPGATHERQQ — Gather Packed Qword Values Using Signed Dword/Qword Indices	5-388
VPGATHERQD/VPGATHERQQ—Gather Packed Dword, Packed Qword with Signed Qword Indices	5-392
VPLZCNTD/Q—Count the Number of Leading Zero Bits for Packed Dword, Packed Qword Values	5-395
VPMADD52HUQ—Packed Multiply of Unsigned 52-bit Unsigned Integers and Add High 52-bit Products to 64-bit Accumulators	5-398
VPMADD52LUQ—Packed Multiply of Unsigned 52-bit Integers and Add the Low 52-bit Products to Qword Accumulators	5-400
VPMASKMOV — Conditional SIMD Integer Packed Loads and Stores	5-402
VPMOVB2M/VPMOVW2M/VPMOVD2M/VPMOVQ2M—Convert a Vector Register to a Mask	5-405
VPMOVDB/VPMOVSDB/VPMOVUSDB—Down Convert DWord to Byte	5-408
VPMOVDW/VPMOVSDW/VPMOVUSDW—Down Convert DWord to Word	5-412
VPMOVM2B/VPMOVM2W/VPMOVM2D/VPMOVM2Q—Convert a Mask Register to a Vector Register	5-416
VPMOVQB/VPMOVSQB/VPMOVUSQB—Down Convert Qword to Byte	5-419
VPMOVQD/VPMOVSQD/VPMOVUSQD—Down Convert Qword to Dword	5-423
VPMOVQW/VPMOVSQW/VPMOVUSQW—Down Convert Qword to Word	5-427
VPMOVWB/VPMOVSWB/VPMOVUSWB—Down Convert Word to Byte	5-431
VPMULTISHIFTQB - Select Packed Unaligned Bytes from Quadword Sources	5-435
VPROLD/VPROLVD/VPROLQ/VPROLVQ—Bit Rotate Left	5-437
VPRORD/VPRORVD/VPRORQ/VPRORVQ—Bit Rotate Right	5-442
VPSCATTERDD/VPSCATTERDQ/VPSCATTERQD/VPSCATTERQQ—Scatter Packed Dword, Packed Qword with Signed Dword, Signed Qword Indices	5-447
VPSLLVW/VPSLLVD/VPSLLVQ—Variable Bit Shift Left Logical	5-451
VPSRAVW/VPSRAVD/VPSRAVQ—Variable Bit Shift Right Arithmetic	5-456
VPSRLVW/VPSRLVD/VPSRLVQ—Variable Bit Shift Right Logical	5-461
VPTERNLOGD/VPTERNLOGQ—Bitwise Ternary Logic	5-466
VPTESTMB/VPTESTMW/VPTESTMD/VPTESTMQ—Logical AND and Set Mask	5-469
VPTESTNMB/W/D/Q—Logical NAND and Set	5-472
VRANGEPD—Range Restriction Calculation For Packed Pairs of Float64 Values	5-476
VRANGEPS—Range Restriction Calculation For Packed Pairs of Float32 Values	5-481
VRANGESD—Range Restriction Calculation From a pair of Scalar Float64 Values	5-485
VRANGESS—Range Restriction Calculation From a Pair of Scalar Float32 Values	5-488
VRCP14PD—Compute Approximate Reciprocals of Packed Float64 Values	5-491
VRCP14SD—Compute Approximate Reciprocal of Scalar Float64 Value	5-493
VRCP14PS—Compute Approximate Reciprocals of Packed Float32 Values	5-495
VRCP14SS—Compute Approximate Reciprocal of Scalar Float32 Value	5-497
VREDUCEPD—Perform Reduction Transformation on Packed Float64 Values	5-499
VREDUCESD—Perform a Reduction Transformation on a Scalar Float64 Value	5-502
VREDUCEPS—Perform Reduction Transformation on Packed Float32 Values	5-504
VREDUCES—Perform a Reduction Transformation on a Scalar Float32 Value	5-506
VRNDSCALEPD—Round Packed Float64 Values To Include A Given Number Of Fraction Bits	5-508
VRNDSCALESD—Round Scalar Float64 Value To Include A Given Number Of Fraction Bits	5-512

VRNDSCALEPS—Round Packed Float32 Values To Include A Given Number Of Fraction Bits .....	5-514
VRNDSCALESS—Round Scalar Float32 Value To Include A Given Number Of Fraction Bits .....	5-517
VRSQRT14PD—Compute Approximate Reciprocals of Square Roots of Packed Float64 Values .....	5-519
VRSQRT14SD—Compute Approximate Reciprocals of Square Root of Scalar Float64 Value .....	5-521
VRSQRT14PS—Compute Approximate Reciprocals of Square Roots of Packed Float32 Values .....	5-523
VRSQRT14SS—Compute Approximate Reciprocal of Square Root of Scalar Float32 Value .....	5-525
VSCALEFPD—Scale Packed Float64 Values With Float64 Values .....	5-527
VSCALEFSD—Scale Scalar Float64 Values With Float64 Values .....	5-530
VSCALEFPS—Scale Packed Float32 Values With Float32 Values .....	5-532
VSCALEFSS—Scale Scalar Float32 Value With Float32 Value .....	5-535
VSCATTERDPS/VSCATTERDPD/VSCATTERQPS/VSCATTERQPD—Scatter Packed Single, Packed Double with Signed Dword and Qword Indices .....	5-537
VSHUFF32x4/VSHUFF64x2/VSHUFI32x4/VSHUFI64x2—Shuffle Packed Values at 128-bit Granularity .....	5-541
VTESTPD/VTESTPS—Packed Bit Test .....	5-546
VZEROALL—Zero All YMM Registers .....	5-549
VZEROUPPER—Zero Upper Bits of YMM Registers .....	5-550
WAIT/FWAIT—Wait .....	5-551
WBINVD—Write Back and Invalidate Cache .....	5-552
WRFSBASE/WRGSBASE—Write FS/GS Segment Base .....	5-554
WRMSR—Write to Model Specific Register .....	5-556
WRPKRU—Write Data to User Page Key Register .....	5-558
XACQUIRE/XRELEASE — Hardware Lock Elision Prefix Hints .....	5-559
XABORT — Transactional Abort .....	5-563
XADD—Exchange and Add .....	5-565
XBEGIN — Transactional Begin .....	5-567
XCHG—Exchange Register/Memory with Register .....	5-570
XEND — Transactional End .....	5-572
XGETBV—Get Value of Extended Control Register .....	5-574
XLAT/XLATB—Table Look-up Translation .....	5-576
XOR—Logical Exclusive OR .....	5-578
XORPD—Bitwise Logical XOR of Packed Double Precision Floating-Point Values .....	5-580
XORPS—Bitwise Logical XOR of Packed Single Precision Floating-Point Values .....	5-583
XRSTOR—Restore Processor Extended States .....	5-586
XRSTORS—Restore Processor Extended States Supervisor .....	5-591
XSAVE—Save Processor Extended States .....	5-595
XSAVEC—Save Processor Extended States with Compaction .....	5-598
XSAVEOPT—Save Processor Extended States Optimized .....	5-601
XSAVES—Save Processor Extended States Supervisor .....	5-604
XSETBV—Set Extended Control Register .....	5-608
XTEST — Test If In Transactional Execution .....	5-610

**CHAPTER 6  
SAFER MODE EXTENSIONS REFERENCE**

6.1	OVERVIEW .....	6-1
6.2	SMX FUNCTIONALITY .....	6-1
6.2.1	Detecting and Enabling SMX .....	6-1
6.2.2	SMX Instruction Summary .....	6-2
6.2.2.1	GETSEC[CAPABILITIES] .....	6-2
6.2.2.2	GETSEC[ENTERACCS] .....	6-3
6.2.2.3	GETSEC[EXITAC] .....	6-3
6.2.2.4	GETSEC[ENTER] .....	6-3
6.2.2.5	GETSEC[SEXIT] .....	6-4
6.2.2.6	GETSEC[PARAMETERS] .....	6-4
6.2.2.7	GETSEC[SMCTRL] .....	6-4
6.2.2.8	GETSEC[WAKEUP] .....	6-4
6.2.3	Measured Environment and SMX .....	6-4
6.3	GETSEC LEAF FUNCTIONS .....	6-5
	GETSEC[CAPABILITIES] - Report the SMX Capabilities .....	6-7
	GETSEC[ENTERACCS] - Execute Authenticated Chipset Code .....	6-10



GETSEC[EXITAC]—Exit Authenticated Code Execution Mode .....	6-18
GETSEC[SENDER]—Enter a Measured Environment .....	6-21
GETSEC[SEXIT]—Exit Measured Environment .....	6-30
GETSEC[PARAMETERS]—Report the SMX Parameters .....	6-33
GETSEC[SMCTRL]—SMX Mode Control .....	6-37
GETSEC[WAKEUP]—Wake up sleeping processors in measured environment .....	6-40

**CHAPTER 7****INSTRUCTION SET REFERENCE UNIQUE TO INTEL® XEON PHI™ PROCESSORS**

PREFETCHWT1—Prefetch Vector Data Into Caches with Intent to Write and T1 Hint .....	6-2
VEXP2PD—Approximation to the Exponential $2^x$ of Packed Double-Precision Floating-Point Values with Less Than $2^{-23}$ Relative Error .....	6-4
VEXP2PS—Approximation to the Exponential $2^x$ of Packed Single-Precision Floating-Point Values with Less Than $2^{-23}$ Relative Error .....	6-6
VGATHERPFODPS/VGATHERPFOQPS/VGATHERPFODPD/VGATHERPFOQPD—Sparse Prefetch Packed SP/DP Data Values with Signed Dword, Signed Qword Indices Using T0 Hint .....	6-8
VGATHERPF1DPS/VGATHERPF1QPS/VGATHERPF1DPD/VGATHERPF1QPD—Sparse Prefetch Packed SP/DP Data Values with Signed Dword, Signed Qword Indices Using T1 Hint .....	6-10
VRCP28PD—Approximation to the Reciprocal of Packed Double-Precision Floating-Point Values with Less Than $2^{-28}$ Relative Error .....	6-12
VRCP28SD—Approximation to the Reciprocal of Scalar Double-Precision Floating-Point Value with Less Than $2^{-28}$ Relative Error .....	6-14
VRCP28PS—Approximation to the Reciprocal of Packed Single-Precision Floating-Point Values with Less Than $2^{-28}$ Relative Error .....	6-16
VRCP28SS—Approximation to the Reciprocal of Scalar Single-Precision Floating-Point Value with Less Than $2^{-28}$ Relative Error .....	6-18
VRSQRT28PD—Approximation to the Reciprocal Square Root of Packed Double-Precision Floating-Point Values with Less Than $2^{-28}$ Relative Error .....	6-20
VRSQRT28SD—Approximation to the Reciprocal Square Root of Scalar Double-Precision Floating-Point Value with Less Than $2^{-28}$ Relative Error .....	6-22
VRSQRT28PS—Approximation to the Reciprocal Square Root of Packed Single-Precision Floating-Point Values with Less Than $2^{-28}$ Relative Error .....	6-24
VRSQRT28SS—Approximation to the Reciprocal Square Root of Scalar Single-Precision Floating-Point Value with Less Than $2^{-28}$ Relative Error .....	6-26
VSCATTERPFODPS/VSCATTERPFOQPS/VSCATTERPFODPD/VSCATTERPFOQPD—Sparse Prefetch Packed SP/DP Data Values with Signed Dword, Signed Qword Indices Using T0 Hint with Intent to Write .....	6-28
VSCATTERPF1DPS/VSCATTERPF1QPS/VSCATTERPF1DPD/VSCATTERPF1QPD—Sparse Prefetch Packed SP/DP Data Values with Signed Dword, Signed Qword Indices Using T1 Hint with Intent to Write .....	6-30

**APPENDIX A****OPCODE MAP**

A.1	USING OPCODE TABLES .....	A-1
A.2	KEY TO ABBREVIATIONS .....	A-1
A.2.1	Codes for Addressing Method .....	A-1
A.2.2	Codes for Operand Type .....	A-2
A.2.3	Register Codes .....	A-3
A.2.4	Opcode Look-up Examples for One, Two, and Three-Byte Opcodes .....	A-3
A.2.4.1	One-Byte Opcode Instructions .....	A-3
A.2.4.2	Two-Byte Opcode Instructions .....	A-4
A.2.4.3	Three-Byte Opcode Instructions .....	A-5
A.2.4.4	VEX Prefix Instructions .....	A-5
A.2.5	Superscripts Utilized in Opcode Tables .....	A-6
A.3	ONE, TWO, AND THREE-BYTE OPCODE MAPS .....	A-6
A.4	OPCODE EXTENSIONS FOR ONE-BYTE AND TWO-BYTE OPCODES .....	A-17
A.4.1	Opcode Look-up Examples Using Opcode Extensions .....	A-17
A.4.2	Opcode Extension Tables .....	A-17
A.5	ESCAPE OPCODE INSTRUCTIONS .....	A-20
A.5.1	Opcode Look-up Examples for Escape Instruction Opcodes .....	A-20
A.5.2	Escape Opcode Instruction Tables .....	A-20

## CONTENTS

	PAGE
A.5.2.1	Escape Opcodes with D8 as First Byte ..... A-20
A.5.2.2	Escape Opcodes with D9 as First Byte ..... A-21
A.5.2.3	Escape Opcodes with DA as First Byte ..... A-22
A.5.2.4	Escape Opcodes with DB as First Byte ..... A-23
A.5.2.5	Escape Opcodes with DC as First Byte ..... A-24
A.5.2.6	Escape Opcodes with DD as First Byte ..... A-25
A.5.2.7	Escape Opcodes with DE as First Byte ..... A-26
A.5.2.8	Escape Opcodes with DF As First Byte ..... A-27

## APPENDIX B

### INSTRUCTION FORMATS AND ENCODINGS

B.1	MACHINE INSTRUCTION FORMAT ..... B-1
B.1.1	Legacy Prefixes ..... B-1
B.1.2	REX Prefixes ..... B-2
B.1.3	Opcode Fields ..... B-2
B.1.4	Special Fields ..... B-2
B.1.4.1	Reg Field (reg) for Non-64-Bit Modes ..... B-3
B.1.4.2	Reg Field (reg) for 64-Bit Mode ..... B-4
B.1.4.3	Encoding of Operand Size (w) Bit ..... B-4
B.1.4.4	Sign-Extend (s) Bit ..... B-5
B.1.4.5	Segment Register (sreg) Field ..... B-5
B.1.4.6	Special-Purpose Register (eee) Field ..... B-5
B.1.4.7	Condition Test (ttn) Field ..... B-6
B.1.4.8	Direction (d) Bit ..... B-6
B.1.5	Other Notes ..... B-6
B.2	GENERAL-PURPOSE INSTRUCTION FORMATS AND ENCODINGS FOR NON-64-BIT MODES ..... B-7
B.2.1	General Purpose Instruction Formats and Encodings for 64-Bit Mode ..... B-18
B.3	PENTIUM <sup>®</sup> PROCESSOR FAMILY INSTRUCTION FORMATS AND ENCODINGS ..... B-38
B.4	64-BIT MODE INSTRUCTION ENCODINGS FOR SIMD INSTRUCTION EXTENSIONS ..... B-38
B.5	MMX INSTRUCTION FORMATS AND ENCODINGS ..... B-39
B.5.1	Granularity Field (gg) ..... B-39
B.5.2	MMX Technology and General-Purpose Register Fields (mmxreg and reg) ..... B-39
B.5.3	MMX Instruction Formats and Encodings Table ..... B-39
B.6	PROCESSOR EXTENDED STATE INSTRUCTION FORMATS AND ENCODINGS ..... B-42
B.7	P6 FAMILY INSTRUCTION FORMATS AND ENCODINGS ..... B-42
B.8	SSE INSTRUCTION FORMATS AND ENCODINGS ..... B-43
B.9	SSE2 INSTRUCTION FORMATS AND ENCODINGS ..... B-49
B.9.1	Granularity Field (gg) ..... B-49
B.10	SSE3 FORMATS AND ENCODINGS TABLE ..... B-60
B.11	SSSE3 FORMATS AND ENCODING TABLE ..... B-61
B.12	AESNI AND PCLMULQDQ INSTRUCTION FORMATS AND ENCODINGS ..... B-64
B.13	SPECIAL ENCODINGS FOR 64-BIT MODE ..... B-65
B.14	SSE4.1 FORMATS AND ENCODING TABLE ..... B-67
B.15	SSE4.2 FORMATS AND ENCODING TABLE ..... B-72
B.16	AVX FORMATS AND ENCODING TABLE ..... B-74
B.17	FLOATING-POINT INSTRUCTION FORMATS AND ENCODINGS ..... B-114
B.18	VMX INSTRUCTIONS ..... B-118
B.19	SMX INSTRUCTIONS ..... B-119

## APPENDIX C

### INTEL<sup>®</sup> C/C++ COMPILER INTRINSICS AND FUNCTIONAL EQUIVALENTS

C.1	SIMPLE INTRINSICS ..... C-2
C.2	COMPOSITE INTRINSICS ..... C-14

## FIGURES

Figure 1-1.	Bit and Byte Order	1-5
Figure 1-2.	Syntax for CPUID, CR, and MSR Data Presentation	1-7
Figure 2-1.	Intel 64 and IA-32 Architectures Instruction Format	2-1
Figure 2-2.	Table Interpretation of ModR/M Byte (C8H)	2-4
Figure 2-3.	Prefix Ordering in 64-bit Mode	2-8
Figure 2-4.	Memory Addressing Without an SIB Byte; REX.X Not Used	2-9
Figure 2-5.	Register-Register Addressing (No Memory Operand); REX.X Not Used	2-9
Figure 2-6.	Memory Addressing With a SIB Byte	2-10
Figure 2-7.	Register Operand Coded in Opcode Byte; REX.X & REX.R Not Used	2-10
Figure 2-8.	Instruction Encoding Format with VEX Prefix	2-13
Figure 2-9.	VEX bit fields	2-15
Figure 2-10.	AVX-512 Instruction Format and the EVEX Prefix	2-36
Figure 2-11.	Bit Field Layout of the EVEX Prefix	2-36
Figure 3-1.	Bit Offset for BIT[RAX, 21]	3-12
Figure 3-2.	Memory Bit Indexing	3-13
Figure 3-3.	ADDSUBPD—Packed Double-FP Add/Subtract	3-45
Figure 3-4.	ADDSUBPS—Packed Single-FP Add/Subtract	3-47
Figure 3-5.	Memory Layout of BNDMOV to/from Memory	3-101
Figure 3-6.	Version Information Returned by CPUID in EAX	3-207
Figure 3-7.	Feature Information Returned in the ECX Register	3-209
Figure 3-8.	Feature Information Returned in the EDX Register	3-211
Figure 3-9.	Determination of Support for the Processor Brand String	3-220
Figure 3-10.	Algorithm for Extracting Processor Frequency	3-221
Figure 3-11.	CVTDQ2PD (VEX.256 encoded version)	3-232
Figure 3-12.	VCVTPD2DQ (VEX.256 encoded version)	3-239
Figure 3-13.	VCVTPD2PS (VEX.256 encoded version)	3-244
Figure 3-14.	CVTPS2PD (VEX.256 encoded version)	3-253
Figure 3-15.	VCVTTPD2DQ (VEX.256 encoded version)	3-269
Figure 3-16.	HADDPD—Packed Double-FP Horizontal Add	3-430
Figure 3-17.	VHADDPD operation	3-431
Figure 3-18.	HADDPS—Packed Single-FP Horizontal Add	3-434
Figure 3-19.	VHADDP operation	3-434
Figure 3-20.	HSUBPD—Packed Double-FP Horizontal Subtract	3-437
Figure 3-21.	VHSUBPD operation	3-438
Figure 3-22.	HSUBPS—Packed Single-FP Horizontal Subtract	3-441
Figure 3-23.	VHSUBPS operation	3-441
Figure 3-24.	INVPCID Descriptor	3-477
Figure 4-1.	Operation of PCMPSTRx and PCMPSTRx	4-6
Figure 4-2.	VMOVDDUP Operation	4-60
Figure 4-3.	MOVSHDUP Operation	4-114
Figure 4-4.	MOVSLDUP Operation	4-117
Figure 4-5.	256-bit VMPSADBw Operation	4-137
Figure 4-6.	Operation of the PACKSSDw Instruction Using 64-bit Operands	4-187
Figure 4-7.	256-bit VPALIGN Instruction Operation	4-220
Figure 4-8.	PDEP Example	4-270
Figure 4-9.	PEXT Example	4-272
Figure 4-10.	256-bit VPHADD Instruction Operation	4-281
Figure 4-11.	PMADDWD Execution Model Using 64-bit Operands	4-302
Figure 4-12.	PMULHUW and PMULHW Instruction Operation Using 64-bit Operands	4-366
Figure 4-13.	PMULLU Instruction Operation Using 64-bit Operands	4-378
Figure 4-14.	PSADBw Instruction Operation Using 64-bit Operands	4-405
Figure 4-15.	PSHUFb with 64-Bit Operands	4-410
Figure 4-16.	256-bit VPSHUFD Instruction Operation	4-413
Figure 4-17.	PSLLw, PSLLD, and PSLLQ Instruction Operation Using 64-bit Operand	4-431
Figure 4-18.	PSRAW and PSRAD Instruction Operation Using a 64-bit Operand	4-443
Figure 4-19.	PSRLw, PSRLD, and PSRLQ Instruction Operation Using 64-bit Operand	4-455
Figure 4-20.	PUNPCKHBW Instruction Operation Using 64-bit Operands	4-489

	PAGE
Figure 4-21.	256-bit VPUNPCKHDQ Instruction Operation ..... 4-489
Figure 4-22.	PUNPCKLBW Instruction Operation Using 64-bit Operands ..... 4-499
Figure 4-23.	256-bit VPUNPCKLDQ Instruction Operation ..... 4-499
Figure 4-24.	Bit Control Fields of Immediate Byte for ROUNDxx Instruction ..... 4-561
Figure 4-25.	256-bit VSHUFDP Operation of Four Pairs of DP FP Values ..... 4-614
Figure 4-26.	256-bit VSHUFPS Operation of Selection from Input Quadruplet and Pair-wise Interleaved Result ..... 4-619
Figure 4-27.	VUNPCKHPS Operation ..... 4-689
Figure 4-28.	VUNPCKLPS Operation ..... 4-697
Figure 5-1.	VBROADCASTSS Operation (VEX.256 encoded version) ..... 5-14
Figure 5-2.	VBROADCASTSS Operation (VEX.128-bit version) ..... 5-14
Figure 5-3.	VBROADCASTSD Operation (VEX.256-bit version) ..... 5-14
Figure 5-4.	VBROADCASTF128 Operation (VEX.256-bit version) ..... 5-14
Figure 5-5.	VBROADCASTF64X4 Operation (512-bit version with writemask all 1s) ..... 5-15
Figure 5-6.	VCVTPH2PS (128-bit Version) ..... 5-34
Figure 5-7.	VCVTPS2PH (128-bit Version) ..... 5-36
Figure 5-8.	64-bit Super Block of SAD Operation in VDBPSADBW ..... 5-85
Figure 5-9.	VFIXUPIMMPD Immediate Control Description ..... 5-109
Figure 5-10.	VFIXUPIMMPS Immediate Control Description ..... 5-113
Figure 5-11.	VFIXUPIMMSD Immediate Control Description ..... 5-116
Figure 5-12.	VFIXUPIMMSS Immediate Control Description ..... 5-119
Figure 5-13.	Imm8 Byte Specifier of Special Case FP Values for VFPCLASSPD/SD/PS/SS ..... 5-236
Figure 5-14.	VGETEXPPS Functionality On Normal Input values ..... 5-265
Figure 5-15.	Imm8 Controls for VGETMANTPD/SD/PS/SS ..... 5-272
Figure 5-16.	VPBROADCASTD Operation (VEX.256 encoded version) ..... 5-306
Figure 5-17.	VPBROADCASTD Operation (128-bit version) ..... 5-306
Figure 5-18.	VPBROADCASTQ Operation (256-bit version) ..... 5-306
Figure 5-19.	VBROADCASTI128 Operation (256-bit version) ..... 5-307
Figure 5-20.	VBROADCASTI256 Operation (512-bit version) ..... 5-307
Figure 5-21.	VPERM2F128 Operation ..... 5-334
Figure 5-22.	VPERM2I128 Operation ..... 5-336
Figure 5-23.	VPERMILPD Operation ..... 5-352
Figure 5-24.	VPERMILPD Shuffle Control ..... 5-352
Figure 5-25.	VPERMILPS Operation ..... 5-357
Figure 5-26.	VPERMILPS Shuffle Control ..... 5-357
Figure 5-27.	Imm8 Controls for VRANGE PD/SD/PS/SS ..... 5-476
Figure 5-28.	Imm8 Controls for VREDUCE PD/SD/PS/SS ..... 5-499
Figure 5-29.	Imm8 Controls for VRNDSCALE PD/SD/PS/SS ..... 5-509
Figure A-1.	ModR/M Byte nnn Field (Bits 5, 4, and 3) ..... A-17
Figure B-1.	General Machine Instruction Format ..... B-1
Figure B-2.	Hybrid Notation of VEX-Encoded Key Instruction Bytes ..... B-74

## TABLES

Table 2-1.	16-Bit Addressing Forms with the ModR/M Byte	2-5
Table 2-2.	32-Bit Addressing Forms with the ModR/M Byte	2-6
Table 2-3.	32-Bit Addressing Forms with the SIB Byte	2-7
Table 2-4.	REX Prefix Fields [BITS: 0100WRXB]	2-9
Table 2-6.	Direct Memory Offset Form of MOV	2-11
Table 2-5.	Special Cases of REX Encodings	2-11
Table 2-7.	RIP-Relative Addressing	2-12
Table 2-8.	VEX.vvvv to register name mapping	2-17
Table 2-9.	Instructions with a VEX.vvvv destination	2-17
Table 2-10.	VEX.m-mmmm interpretation	2-18
Table 2-11.	VEX.L interpretation	2-18
Table 2-12.	VEX.pp interpretation	2-19
Table 2-13.	32-Bit VSIB Addressing Forms of the SIB Byte	2-20
Table 2-14.	Exception class description	2-22
Table 2-15.	Instructions in each Exception Class	2-23
Table 2-16.	#UD Exception and VEX.W=1 Encoding	2-24
Table 2-17.	#UD Exception and VEX.L Field Encoding	2-25
Table 2-18.	Type 1 Class Exception Conditions	2-26
Table 2-19.	Type 2 Class Exception Conditions	2-27
Table 2-20.	Type 3 Class Exception Conditions	2-28
Table 2-21.	Type 4 Class Exception Conditions	2-29
Table 2-22.	Type 5 Class Exception Conditions	2-30
Table 2-23.	Type 6 Class Exception Conditions	2-31
Table 2-24.	Type 7 Class Exception Conditions	2-32
Table 2-25.	Type 8 Class Exception Conditions	2-32
Table 2-26.	Type 11 Class Exception Conditions	2-33
Table 2-27.	Type 12 Class Exception Conditions	2-34
Table 2-28.	VEX-Encoded GPR Instructions	2-35
Table 2-29.	Exception Definition (VEX-Encoded GPR Instructions)	2-35
Table 2-30.	EVEX Prefix Bit Field Functional Grouping	2-37
Table 2-31.	32-Register Support in 64-bit Mode Using EVEX with Embedded REX Bits	2-38
Table 2-32.	EVEX Encoding Register Specifiers in 32-bit Mode	2-38
Table 2-33.	Opmask Register Specifier Encoding	2-39
Table 2-34.	Compressed Displacement (DISP8*N) Affected by Embedded Broadcast	2-40
Table 2-35.	EVEX DISP8*N for Instructions Not Affected by Embedded Broadcast	2-40
Table 2-36.	EVEX Embedded Broadcast/Rounding/SAE and Vector Length on Vector Instructions	2-42
Table 2-37.	OS XSAVE Enabling Requirements of Instruction Categories	2-42
Table 2-38.	Opcode Independent, State Dependent EVEX Bit Fields	2-42
Table 2-39.	#UD Conditions of Operand-Encoding EVEX Prefix Bit Fields	2-43
Table 2-40.	#UD Conditions of Opmask Related Encoding Field	2-43
Table 2-41.	#UD Conditions Dependent on EVEX.b Context	2-44
Table 2-42.	EVEX-Encoded Instruction Exception Class Summary	2-44
Table 2-43.	EVEX Instructions in each Exception Class	2-45
Table 2-44.	Type E1 Class Exception Conditions	2-48
Table 2-45.	Type E1NF Class Exception Conditions	2-49
Table 2-46.	Type E2 Class Exception Conditions	2-50
Table 2-47.	Type E3 Class Exception Conditions	2-51
Table 2-48.	Type E3NF Class Exception Conditions	2-52
Table 2-49.	Type E4 Class Exception Conditions	2-53
Table 2-50.	Type E4NF Class Exception Conditions	2-54
Table 2-51.	Type E5 Class Exception Conditions	2-55
Table 2-52.	Type E5NF Class Exception Conditions	2-56
Table 2-53.	Type E6 Class Exception Conditions	2-57
Table 2-54.	Type E6NF Class Exception Conditions	2-58
Table 2-55.	Type E7NM Class Exception Conditions	2-59
Table 2-56.	Type E9 Class Exception Conditions	2-60
Table 2-57.	Type E9NF Class Exception Conditions	2-61

Table 2-58.	Type E10 Class Exception Conditions	2-62
Table 2-59.	Type E10NF Class Exception Conditions	2-63
Table 2-60.	Type E11 Class Exception Conditions	2-64
Table 2-61.	Type E12 Class Exception Conditions	2-65
Table 2-62.	Type E12NP Class Exception Conditions	2-66
Table 2-63.	TYPE K20 Exception Definition (VEX-Encoded OpMask Instructions w/o Memory Arg)	2-67
Table 2-64.	TYPE K21 Exception Definition (VEX-Encoded OpMask Instructions Addressing Memory)	2-68
Table 3-1.	Register Codes Associated With +rb, +rw, +rd, +ro	3-2
Table 3-2.	Range of Bit Positions Specified by Bit Offset Operands	3-13
Table 3-3.	Standard and Non-standard Data Types	3-15
Table 3-4.	Intel 64 and IA-32 General Exceptions	3-16
Table 3-5.	x87 FPU Floating-Point Exceptions	3-17
Table 3-6.	SIMD Floating-Point Exceptions	3-17
Table 3-7.	Decision Table for CLI Results	3-144
Table 3-1.	Comparison Predicate for CMPPD and CMPPS Instructions	3-157
Table 3-2.	Pseudo-Op and CMPPD Implementation	3-158
Table 3-3.	Pseudo-Op and VCMPPD Implementation	3-159
Table 3-4.	Pseudo-Op and CMPPS Implementation	3-164
Table 3-5.	Pseudo-Op and VCMPPS Implementation	3-165
Table 3-6.	Pseudo-Op and CMPSD Implementation	3-175
Table 3-7.	Pseudo-Op and VCMPSD Implementation	3-175
Table 3-8.	Pseudo-Op and CMPSS Implementation	3-179
Table 3-9.	Pseudo-Op and VCMPS Implementation	3-179
Table 3-8.	Information Returned by CPUID Instruction	3-192
Table 3-9.	Processor Type Field	3-207
Table 3-10.	Feature Information Returned in the ECX Register	3-209
Table 3-11.	More on Feature Information Returned in the EDX Register	3-212
Table 3-12.	Encoding of CPUID Leaf 2 Descriptors	3-214
Table 3-13.	Processor Brand String Returned with Pentium 4 Processor	3-221
Table 3-14.	Mapping of Brand Indices; and Intel 64 and IA-32 Processor Brand Strings	3-222
Table 3-15.	DIV Action	3-288
Table 3-16.	Results Obtained from F2XM1	3-312
Table 3-17.	Results Obtained from FABS	3-314
Table 3-18.	FADD/FADDP/FIADD Results	3-316
Table 3-19.	FBSTP Results	3-320
Table 3-20.	FCHS Results	3-322
Table 3-21.	FCOM/FCOMP/FCOMPP Results	3-328
Table 3-22.	FCOMI/FCOMIP/ FUCOMI/FUCOMIP Results	3-331
Table 3-23.	FCOS Results	3-334
Table 3-24.	FDIV/FDIVP/FIDIV Results	3-338
Table 3-25.	FDIVR/FDIVRP/FIDIVR Results	3-341
Table 3-26.	FICOM/FICOMP Results	3-344
Table 3-27.	FIST/FISTP Results	3-351
Table 3-28.	FISTTP Results	3-354
Table 3-29.	FMUL/FMULP/FIMUL Results	3-365
Table 3-30.	FPATAN Results	3-368
Table 3-31.	FPREM Results	3-370
Table 3-32.	FPREM1 Results	3-372
Table 3-33.	FPTAN Results	3-374
Table 3-34.	FSCALE Results	3-382
Table 3-35.	FSIN Results	3-384
Table 3-36.	FSINCOS Results	3-386
Table 3-37.	FSQRT Results	3-388
Table 3-38.	FSUB/FSUBP/FISUB Results	3-399
Table 3-39.	FSUBR/FSUBRP/FISUBR Results	3-402
Table 3-40.	FTST Results	3-404
Table 3-41.	FUCOM/FUCOMP/FUCOMPP Results	3-406
Table 3-42.	FXAM Results	3-409
Table 3-43.	Non-64-bit-Mode Layout of FXSAVE and FXRSTOR	

	Memory Region3-416	
Table 3-44.	Field Definitions .....	3-417
Table 3-45.	Recreating FSAVE Format .....	3-419
Table 3-46.	Layout of the 64-bit-mode FXSAVE64 Map (requires REX.W = 1)3-420	
Table 3-47.	Layout of the 64-bit-mode FXSAVE Map (REX.W = 0).....	3-421
Table 3-48.	FYL2X Results .....	3-426
Table 3-49.	FYL2XP1 Results.....	3-428
Table 3-50.	IDIV Results.....	3-443
Table 3-51.	Decision Table.....	3-461
Table 3-52.	Segment and Gate Types .....	3-520
Table 3-53.	Non-64-bit Mode LEA Operation with Address and Operand Size Attributes .....	3-529
Table 3-54.	64-bit Mode LEA Operation with Address and Operand Size Attributes.....	3-529
Table 3-55.	Segment and Gate Descriptor Types.....	3-549
Table 4-1.	Source Data Format .....	4-2
Table 4-2.	Aggregation Operation .....	4-2
Table 4-3.	Aggregation Operation .....	4-3
Table 4-4.	Polarity .....	4-3
Table 4-5.	Output Selection .....	4-4
Table 4-6.	Output Selection .....	4-4
Table 4-7.	Comparison Result for Each Element Pair BoolRes[i,j].....	4-4
Table 4-8.	Summary of Imm8 Control Byte .....	4-5
Table 4-9.	MUL Results.....	4-144
Table 4-10.	MWAIT Extension Register (ECX).....	4-159
Table 4-11.	MWAIT Hints Register (EAX) .....	4-159
Table 4-12.	Recommended Multi-Byte Sequence of NOP Instruction .....	4-163
Table 4-13.	PCLMULQDQ Quadword Selection of Immediate Byte.....	4-241
Table 4-14.	Pseudo-Op and PCLMULQDQ Implementation .....	4-241
Table 4-15.	Effect of POPF/POPFD on the EFLAGS Register .....	4-394
Table 4-16.	Valid General and Special Purpose Performance Counter Index Range for RDPMC.....	4-533
Table 4-17.	Repeat Prefixes.....	4-546
Table 4-18.	Rounding Modes and Encoding of Rounding Control (RC) Field.....	4-561
Table 4-19.	Decision Table for STI Results.....	4-641
Table 5-1.	Low 8 columns of the 16x16 Map of VPTERNLOG Boolean Logic Operations.....	5-2
Table 5-2.	Low 8 columns of the 16x16 Map of VPTERNLOG Boolean Logic Operations.....	5-3
Table 5-3.	Immediate Byte Encoding for 16-bit Floating-Point Conversion Instructions .....	5-37
Table 5-4.	Classifier Operations for VFPCLASSPD/SD/PS/SS.....	5-236
Table 5-5.	VGETEXPPD/SD Special Cases.....	5-261
Table 5-6.	VGETEXPPS/SS Special Cases .....	5-264
Table 5-7.	GetMant() Special Float Values Behavior .....	5-273
Table 5-8.	Pseudo-Op and VPCMP* Implementation.....	5-316
Table 5-9.	Examples of VPTERNLOGD/Q Imm8 Boolean Function and Input Index Values .....	5-467
Table 5-10.	Signaling of Comparison Operation of One or More NaN Input Values and Effect of Imm8[3:2] .....	5-477
Table 5-11.	Comparison Result for Opposite-Signed Zero Cases for MIN, MIN_ABS and MAX, MAX_ABS.....	5-477
Table 5-12.	Comparison Result of Equal-Magnitude Input Cases for MIN_ABS and MAX_ABS, ( a  =  b , a>0, b<0).....	5-477
Table 5-13.	VRCP14PD/VRCP14SD Special Cases .....	5-491
Table 5-14.	VRCP14PS/VRCP14SS Special Cases .....	5-495
Table 5-15.	VREDUCEPD/SD/PS/SS Special Cases .....	5-500
Table 5-16.	VRNDSCALEPD/SD/PS/SS Special Cases.....	5-509
Table 5-17.	VRSQRT14PD Special Cases .....	5-520
Table 5-18.	VRSQRT14SD Special Cases.....	5-522
Table 5-19.	VRSQRT14PS Special Cases.....	5-524
Table 5-20.	VRSQRT14SS Special Cases.....	5-526
Table 5-21.	VSCALEFPD/SD/PS/SS Special Cases.....	5-527
Table 5-22.	Additional VSCALEFPD/SD Special Cases.....	5-528
Table 5-23.	Additional VSCALEFPS/SS Special Cases .....	5-532
Table 6-1.	Layout of IA32_FEATURE_CONTROL.....	6-2
Table 6-2.	GETSEC Leaf Functions .....	6-3
Table 6-3.	Getsec Capability Result Encoding (EBX = 0) .....	6-7

Table 6-4.	Register State Initialization after GETSEC[ENTERACCS] .....	6-12
Table 6-5.	IA32_MISC_ENABLE MSR Initialization by ENTERACCS and SENTER .....	6-13
Table 6-6.	Register State Initialization after GETSEC[SENDER] and GETSEC[WAKEUP] .....	6-24
Table 6-7.	SMX Reporting Parameters Format .....	6-33
Table 6-8.	TXT Feature Extensions Flags .....	6-34
Table 6-9.	External Memory Types Using Parameter 3 .....	6-35
Table 6-10.	Default Parameter Values .....	6-35
Table 6-11.	Supported Actions for GETSEC[SMCTRL(0)] .....	6-37
Table 6-12.	RLP MVMEM JOIN Data Structure .....	6-40
Table 6-1.	Special Values Behavior .....	6-5
Table 6-2.	Special Values Behavior .....	6-7
Table 6-3.	VRCP28PD Special Cases .....	6-13
Table 6-4.	VRCP28SD Special Cases .....	6-15
Table 6-5.	VRCP28PS Special Cases .....	6-17
Table 6-6.	VRCP28SS Special Cases .....	6-19
Table 6-7.	VRSQRT28PD Special Cases .....	6-21
Table 6-8.	VRSQRT28SD Special Cases .....	6-23
Table 6-9.	VRSQRT28PS Special Cases .....	6-25
Table 6-10.	VRSQRT28SS Special Cases .....	6-27
Table A-1.	Superscripts Utilized in Opcode Tables .....	A-6
Table A-2.	One-byte Opcode Map: (00H — F7H) * .....	A-7
Table A-3.	Two-byte Opcode Map: 00H — 77H (First Byte is 0FH) * .....	A-9
Table A-4.	Three-byte Opcode Map: 00H — F7H (First Two Bytes are 0F 38H) * .....	A-13
Table A-5.	Three-byte Opcode Map: 00H — F7H (First two bytes are 0F 3AH) * .....	A-15
Table A-6.	Opcode Extensions for One- and Two-byte Opcodes by Group Number * .....	A-18
Table A-7.	D8 Opcode Map When ModR/M Byte is Within 00H to BFH * .....	A-20
Table A-8.	D8 Opcode Map When ModR/M Byte is Outside 00H to BFH * .....	A-21
Table A-9.	D9 Opcode Map When ModR/M Byte is Within 00H to BFH * .....	A-21
Table A-10.	D9 Opcode Map When ModR/M Byte is Outside 00H to BFH * .....	A-22
Table A-11.	DA Opcode Map When ModR/M Byte is Within 00H to BFH * .....	A-22
Table A-12.	DA Opcode Map When ModR/M Byte is Outside 00H to BFH * .....	A-23
Table A-13.	DB Opcode Map When ModR/M Byte is Within 00H to BFH * .....	A-23
Table A-14.	DB Opcode Map When ModR/M Byte is Outside 00H to BFH * .....	A-24
Table A-15.	DC Opcode Map When ModR/M Byte is Within 00H to BFH * .....	A-24
Table A-16.	DC Opcode Map When ModR/M Byte is Outside 00H to BFH * .....	A-25
Table A-17.	DD Opcode Map When ModR/M Byte is Within 00H to BFH * .....	A-25
Table A-18.	DD Opcode Map When ModR/M Byte is Outside 00H to BFH * .....	A-26
Table A-19.	DE Opcode Map When ModR/M Byte is Within 00H to BFH * .....	A-26
Table A-20.	DE Opcode Map When ModR/M Byte is Outside 00H to BFH * .....	A-27
Table A-21.	DF Opcode Map When ModR/M Byte is Within 00H to BFH * .....	A-27
Table A-22.	DF Opcode Map When ModR/M Byte is Outside 00H to BFH * .....	A-28
Table B-1.	Special Fields Within Instruction Encodings .....	B-2
Table B-2.	Encoding of reg Field When w Field is Not Present in Instruction .....	B-3
Table B-3.	Encoding of reg Field When w Field is Present in Instruction .....	B-3
Table B-4.	Encoding of reg Field When w Field is Not Present in Instruction .....	B-4
Table B-5.	Encoding of reg Field When w Field is Present in Instruction .....	B-4
Table B-6.	Encoding of Operand Size (w) Bit .....	B-4
Table B-7.	Encoding of Sign-Extend (s) Bit .....	B-5
Table B-8.	Encoding of the Segment Register (sreg) Field .....	B-5
Table B-9.	Encoding of Special-Purpose Register (eee) Field .....	B-5
Table B-10.	Encoding of Conditional Test (ttn) Field .....	B-6
Table B-11.	Encoding of Operation Direction (d) Bit .....	B-6
Table B-13.	General Purpose Instruction Formats and Encodings for Non-64-Bit Modes .....	B-7
Table B-12.	Notes on Instruction Encoding .....	B-7
Table B-14.	Special Symbols .....	B-18
Table B-15.	General Purpose Instruction Formats and Encodings for 64-Bit Mode .....	B-18
Table B-16.	Pentium Processor Family Instruction Formats and Encodings, Non-64-Bit Modes .....	B-38
Table B-17.	Pentium Processor Family Instruction Formats and Encodings, 64-Bit Mode .....	B-38
Table B-18.	Encoding of Granularity of Data Field (gg) .....	B-39



	PAGE
Table B-19. MMX Instruction Formats and Encodings.....	B-39
Table B-20. Formats and Encodings of XSAVE/XRSTOR/XGETBV/XSETBV Instructions.....	B-42
Table B-21. Formats and Encodings of P6 Family Instructions.....	B-42
Table B-22. Formats and Encodings of SSE Floating-Point Instructions.....	B-43
Table B-23. Formats and Encodings of SSE Integer Instructions.....	B-48
Table B-25. Encoding of Granularity of Data Field (gg).....	B-49
Table B-24. Format and Encoding of SSE Cacheability & Memory Ordering Instructions.....	B-49
Table B-26. Formats and Encodings of SSE2 Floating-Point Instructions.....	B-50
Table B-27. Formats and Encodings of SSE2 Integer Instructions.....	B-55
Table B-28. Format and Encoding of SSE2 Cacheability Instructions.....	B-59
Table B-29. Formats and Encodings of SSE3 Floating-Point Instructions.....	B-60
Table B-30. Formats and Encodings for SSE3 Event Management Instructions.....	B-60
Table B-31. Formats and Encodings for SSE3 Integer and Move Instructions.....	B-61
Table B-32. Formats and Encodings for SSSE3 Instructions.....	B-61
Table B-33. Formats and Encodings of AESNI and PCLMULQDQ Instructions.....	B-64
Table B-34. Special Case Instructions Promoted Using REX.W.....	B-65
Table B-35. Encodings of SSE4.1 instructions.....	B-67
Table B-36. Encodings of SSE4.2 instructions.....	B-73
Table B-37. Encodings of AVX instructions.....	B-74
Table B-38. General Floating-Point Instruction Formats.....	B-114
Table B-39. Floating-Point Instruction Formats and Encodings.....	B-114
Table B-40. Encodings for VMX Instructions.....	B-118
Table B-41. Encodings for SMX Instructions.....	B-119
Table C-1. Simple Intrinsics.....	C-2
Table C-2. Composite Intrinsics.....	C-14



The *Intel® 64 and IA-32 Architectures Software Developer's Manual, Volumes 2A, 2B, 2C & 2D: Instruction Set Reference* (order numbers 253666, 253667, 326018 and 334569) are part of a set that describes the architecture and programming environment of all Intel 64 and IA-32 architecture processors. Other volumes in this set are:

- The *Intel® 64 and IA-32 Architectures Software Developer's Manual, Volume 1: Basic Architecture* (Order Number 253665).
- The *Intel® 64 and IA-32 Architectures Software Developer's Manual, Volumes 3A, 3B, 3C & 3D: System Programming Guide* (order numbers 253668, 253669, 326019 and 332831).
- The *Intel® 64 and IA-32 Architectures Software Developer's Manual, Volume 4: Model-Specific Registers* (order number 335592).

The *Intel® 64 and IA-32 Architectures Software Developer's Manual, Volume 1*, describes the basic architecture and programming environment of Intel 64 and IA-32 processors. The *Intel® 64 and IA-32 Architectures Software Developer's Manual, Volumes 2A, 2B, 2C & 2D*, describe the instruction set of the processor and the opcode structure. These volumes apply to application programmers and to programmers who write operating systems or executives. The *Intel® 64 and IA-32 Architectures Software Developer's Manual, Volumes 3A, 3B, 3C & 3D*, describe the operating-system support environment of Intel 64 and IA-32 processors. These volumes target operating-system and BIOS designers. In addition, the *Intel® 64 and IA-32 Architectures Software Developer's Manual, Volume 3B*, addresses the programming environment for classes of software that host operating systems. The *Intel® 64 and IA-32 Architectures Software Developer's Manual, Volume 4*, describes the model-specific registers of Intel 64 and IA-32 processors.

## 1.1 INTEL® 64 AND IA-32 PROCESSORS COVERED IN THIS MANUAL

This manual set includes information pertaining primarily to the most recent Intel 64 and IA-32 processors, which include:

- Pentium® processors
- P6 family processors
- Pentium® 4 processors
- Pentium® M processors
- Intel® Xeon® processors
- Pentium® D processors
- Pentium® processor Extreme Editions
- 64-bit Intel® Xeon® processors
- Intel® Core™ Duo processor
- Intel® Core™ Solo processor
- Dual-Core Intel® Xeon® processor LV
- Intel® Core™2 Duo processor
- Intel® Core™2 Quad processor Q6000 series
- Intel® Xeon® processor 3000, 3200 series
- Intel® Xeon® processor 5000 series
- Intel® Xeon® processor 5100, 5300 series
- Intel® Core™2 Extreme processor X7000 and X6800 series
- Intel® Core™2 Extreme processor QX6000 series
- Intel® Xeon® processor 7100 series

## ABOUT THIS MANUAL

- Intel® Pentium® Dual-Core processor
- Intel® Xeon® processor 7200, 7300 series
- Intel® Xeon® processor 5200, 5400, 7400 series
- Intel® Core™2 Extreme processor QX9000 and X9000 series
- Intel® Core™2 Quad processor Q9000 series
- Intel® Core™2 Duo processor E8000, T9000 series
- Intel® Atom™ processor family
- Intel® Atom™ processors 200, 300, D400, D500, D2000, N200, N400, N2000, E2000, Z500, Z600, Z2000, C1000 series are built from 45 nm and 32 nm processes
- Intel® Core™ i7 processor
- Intel® Core™ i5 processor
- Intel® Xeon® processor E7-8800/4800/2800 product families
- Intel® Core™ i7-3930K processor
- 2nd generation Intel® Core™ i7-2xxx, Intel® Core™ i5-2xxx, Intel® Core™ i3-2xxx processor series
- Intel® Xeon® processor E3-1200 product family
- Intel® Xeon® processor E5-2400/1400 product family
- Intel® Xeon® processor E5-4600/2600/1600 product family
- 3rd generation Intel® Core™ processors
- Intel® Xeon® processor E3-1200 v2 product family
- Intel® Xeon® processor E5-2400/1400 v2 product families
- Intel® Xeon® processor E5-4600/2600/1600 v2 product families
- Intel® Xeon® processor E7-8800/4800/2800 v2 product families
- 4th generation Intel® Core™ processors
- The Intel® Core™ M processor family
- Intel® Core™ i7-59xx Processor Extreme Edition
- Intel® Core™ i7-49xx Processor Extreme Edition
- Intel® Xeon® processor E3-1200 v3 product family
- Intel® Xeon® processor E5-2600/1600 v3 product families
- 5th generation Intel® Core™ processors
- Intel® Xeon® processor D-1500 product family
- Intel® Xeon® processor E5 v4 family
- Intel® Atom™ processor X7-Z8000 and X5-Z8000 series
- Intel® Atom™ processor Z3400 series
- Intel® Atom™ processor Z3500 series
- 6th generation Intel® Core™ processors
- Intel® Xeon® processor E3-1500m v5 product family
- 7th generation Intel® Core™ processors
- Intel® Xeon Phi™ Processor 3200, 5200, 7200 Series
- Intel® Xeon® Processor Scalable Family

P6 family processors are IA-32 processors based on the P6 family microarchitecture. This includes the Pentium® Pro, Pentium® II, Pentium® III, and Pentium® III Xeon® processors.

The Pentium® 4, Pentium® D, and Pentium® processor Extreme Editions are based on the Intel NetBurst® microarchitecture. Most early Intel® Xeon® processors are based on the Intel NetBurst® microarchitecture. Intel Xeon processor 5000, 7100 series are based on the Intel NetBurst® microarchitecture.

The Intel® Core™ Duo, Intel® Core™ Solo and dual-core Intel® Xeon® processor LV are based on an improved Pentium® M processor microarchitecture.

The Intel® Xeon® processor 3000, 3200, 5100, 5300, 7200, and 7300 series, Intel® Pentium® dual-core, Intel® Core™2 Duo, Intel® Core™2 Quad, and Intel® Core™2 Extreme processors are based on Intel® Core™ microarchitecture.

The Intel® Xeon® processor 5200, 5400, 7400 series, Intel® Core™2 Quad processor Q9000 series, and Intel® Core™2 Extreme processors QX9000, X9000 series, Intel® Core™2 processor E8000 series are based on Enhanced Intel® Core™ microarchitecture.

The Intel® Atom™ processors 200, 300, D400, D500, D2000, N200, N400, N2000, E2000, Z500, Z600, Z2000, C1000 series are based on the Intel® Atom™ microarchitecture and supports Intel 64 architecture.

P6 family, Pentium® M, Intel® Core™ Solo, Intel® Core™ Duo processors, dual-core Intel® Xeon® processor LV, and early generations of Pentium 4 and Intel Xeon processors support IA-32 architecture. The Intel® Atom™ processor Z5xx series support IA-32 architecture.

The Intel® Xeon® processor 3000, 3200, 5000, 5100, 5200, 5300, 5400, 7100, 7200, 7300, 7400 series, Intel® Core™2 Duo, Intel® Core™2 Extreme, Intel® Core™2 Quad processors, Pentium® D processors, Pentium® Dual-Core processor, newer generations of Pentium 4 and Intel Xeon processor family support Intel® 64 architecture.

The Intel® Core™ i7 processor and Intel® Xeon® processor 3400, 5500, 7500 series are based on 45 nm Intel® microarchitecture code name Nehalem. Intel® microarchitecture code name Westmere is a 32 nm version of Intel® microarchitecture code name Nehalem. Intel® Xeon® processor 5600 series, Intel Xeon processor E7 and various Intel Core i7, i5, i3 processors are based on Intel® microarchitecture code name Westmere. These processors support Intel 64 architecture.

The Intel® Xeon® processor E5 family, Intel® Xeon® processor E3-1200 family, Intel® Xeon® processor E7-8800/4800/2800 product families, Intel® Core™ i7-3930K processor, and 2nd generation Intel® Core™ i7-2xxx, Intel® Core™ i5-2xxx, Intel® Core™ i3-2xxx processor series are based on the Intel® microarchitecture code name Sandy Bridge and support Intel 64 architecture.

The Intel® Xeon® processor E7-8800/4800/2800 v2 product families, Intel® Xeon® processor E3-1200 v2 product family and 3rd generation Intel® Core™ processors are based on the Intel® microarchitecture code name Ivy Bridge and support Intel 64 architecture.

The Intel® Xeon® processor E5-4600/2600/1600 v2 product families, Intel® Xeon® processor E5-2400/1400 v2 product families and Intel® Core™ i7-49xx Processor Extreme Edition are based on the Intel® microarchitecture code name Ivy Bridge-E and support Intel 64 architecture.

The Intel® Xeon® processor E3-1200 v3 product family and 4th Generation Intel® Core™ processors are based on the Intel® microarchitecture code name Haswell and support Intel 64 architecture.

The Intel® Xeon® processor E5-2600/1600 v3 product families and the Intel® Core™ i7-59xx Processor Extreme Edition are based on the Intel® microarchitecture code name Haswell-E and support Intel 64 architecture.

The Intel® Atom™ processor Z8000 series is based on the Intel microarchitecture code name Airmont.

The Intel® Atom™ processor Z3400 series and the Intel® Atom™ processor Z3500 series are based on the Intel microarchitecture code name Silvermont.

The Intel® Core™ M processor family, 5th generation Intel® Core™ processors, Intel® Xeon® processor D-1500 product family and the Intel® Xeon® processor E5 v4 family are based on the Intel® microarchitecture code name Broadwell and support Intel 64 architecture.

The Intel® Xeon® Processor Scalable Family, Intel® Xeon® processor E3-1500m v5 product family and 6th generation Intel® Core™ processors are based on the Intel® microarchitecture code name Skylake and support Intel 64 architecture.

The 7th generation Intel® Core™ processors are based on the Intel® microarchitecture code name Kaby Lake and support Intel 64 architecture.

The Intel® Xeon Phi™ Processor 3200, 5200, 7200 Series is based on the Intel® microarchitecture code name Knights Landing and supports Intel 64 architecture.

IA-32 architecture is the instruction set architecture and programming environment for Intel's 32-bit microprocessors. Intel® 64 architecture is the instruction set architecture and programming environment which is the superset of Intel's 32-bit and 64-bit architectures. It is compatible with the IA-32 architecture.

## 1.2 OVERVIEW OF VOLUME 2A, 2B, 2C AND 2D: INSTRUCTION SET REFERENCE

A description of *Intel® 64 and IA-32 Architectures Software Developer's Manual, Volumes 2A, 2B, 2C & 2D* content follows:

**Chapter 1 — About This Manual.** Gives an overview of all seven volumes of the *Intel® 64 and IA-32 Architectures Software Developer's Manual*. It also describes the notational conventions in these manuals and lists related Intel® manuals and documentation of interest to programmers and hardware designers.

**Chapter 2 — Instruction Format.** Describes the machine-level instruction format used for all IA-32 instructions and gives the allowable encodings of prefixes, the operand-identifier byte (ModR/M byte), the addressing-mode specifier byte (SIB byte), and the displacement and immediate bytes.

**Chapter 3 — Instruction Set Reference, A-L.** Describes Intel 64 and IA-32 instructions in detail, including an algorithmic description of operations, the effect on flags, the effect of operand- and address-size attributes, and the exceptions that may be generated. The instructions are arranged in alphabetical order. General-purpose, x87 FPU, Intel MMX™ technology, SSE/SSE2/SSE3/SSSE3/SSE4 extensions, and system instructions are included.

**Chapter 4 — Instruction Set Reference, M-U.** Continues the description of Intel 64 and IA-32 instructions started in Chapter 3. It starts *Intel® 64 and IA-32 Architectures Software Developer's Manual, Volume 2B*.

**Chapter 5 — Instruction Set Reference, V-Z.** Continues the description of Intel 64 and IA-32 instructions started in chapters 3 and 4. It provides the balance of the alphabetized list of instructions and starts *Intel® 64 and IA-32 Architectures Software Developer's Manual, Volume 2C*.

**Chapter 6— Safer Mode Extensions Reference.** Describes the safer mode extensions (SMX). SMX is intended for a system executive to support launching a measured environment in a platform where the identity of the software controlling the platform hardware can be measured for the purpose of making trust decisions. This chapter starts *Intel® 64 and IA-32 Architectures Software Developer's Manual, Volume 2D*.

**Appendix A — Opcode Map.** Gives an opcode map for the IA-32 instruction set.

**Appendix B — Instruction Formats and Encodings.** Gives the binary encoding of each form of each IA-32 instruction.

**Appendix C — Intel® C/C++ Compiler Intrinsics and Functional Equivalents.** Lists the Intel® C/C++ compiler intrinsics and their assembly code equivalents for each of the IA-32 MMX and SSE/SSE2/SSE3 instructions.

## 1.3 NOTATIONAL CONVENTIONS

This manual uses specific notation for data-structure formats, for symbolic representation of instructions, and for hexadecimal and binary numbers. A review of this notation makes the manual easier to read.

### 1.3.1 Bit and Byte Order

In illustrations of data structures in memory, smaller addresses appear toward the bottom of the figure; addresses increase toward the top. Bit positions are numbered from right to left. The numerical value of a set bit is equal to two raised to the power of the bit position. IA-32 processors are "little endian" machines; this means the bytes of a word are numbered starting from the least significant byte. Figure 1-1 illustrates these conventions.

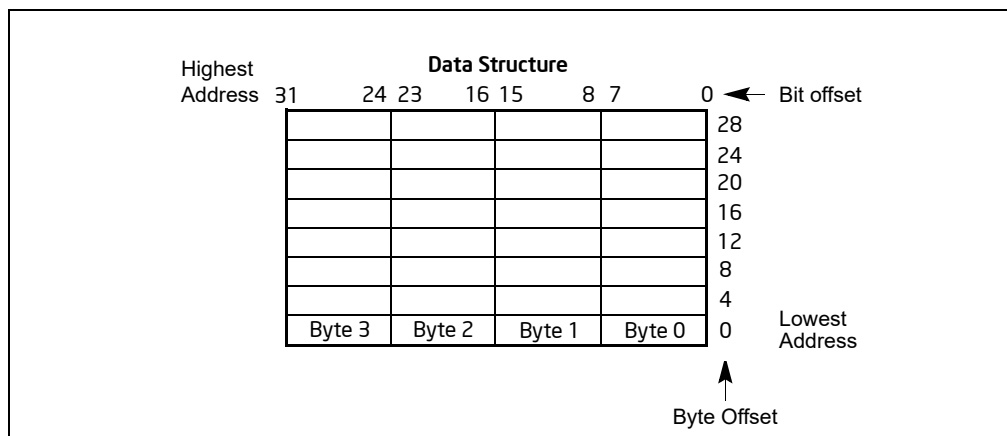

Figure 1-1. Bit and Byte Order

### 1.3.2 Reserved Bits and Software Compatibility

In many register and memory layout descriptions, certain bits are marked as *reserved*. When bits are marked as reserved, it is essential for compatibility with future processors that software treat these bits as having a future, though unknown, effect. The behavior of reserved bits should be regarded as not only undefined, but unpredictable. Software should follow these guidelines in dealing with reserved bits:

- Do not depend on the states of any reserved bits when testing the values of registers which contain such bits. Mask out the reserved bits before testing.
- Do not depend on the states of any reserved bits when storing to memory or to a register.
- Do not depend on the ability to retain information written into any reserved bits.
- When loading a register, always load the reserved bits with the values indicated in the documentation, if any, or reload them with values previously read from the same register.

#### NOTE

Avoid any software dependence upon the state of reserved bits in IA-32 registers. Depending upon the values of reserved register bits will make software dependent upon the unspecified manner in which the processor handles these bits. Programs that depend upon reserved values risk incompatibility with future processors.

### 1.3.3 Instruction Operands

When instructions are represented symbolically, a subset of the IA-32 assembly language is used. In this subset, an instruction has the following format:

```
label: mnemonic argument1, argument2, argument3
```

where:

- A **label** is an identifier which is followed by a colon.
- A **mnemonic** is a reserved name for a class of instruction opcodes which have the same function.
- The operands *argument1*, *argument2*, and *argument3* are optional. There may be from zero to three operands, depending on the opcode. When present, they take the form of either literals or identifiers for data items. Operand identifiers are either reserved names of registers or are assumed to be assigned to data items declared in another part of the program (which may not be shown in the example).

When two operands are present in an arithmetic or logical instruction, the right operand is the source and the left operand is the destination.

For example:

```
LOADREG: MOV EAX, SUBTOTAL
```

In this example, LOADREG is a label, MOV is the mnemonic identifier of an opcode, EAX is the destination operand, and SUBTOTAL is the source operand. Some assembly languages put the source and destination in reverse order.

### 1.3.4 Hexadecimal and Binary Numbers

Base 16 (hexadecimal) numbers are represented by a string of hexadecimal digits followed by the character H (for example, F82EH). A hexadecimal digit is a character from the following set: 0, 1, 2, 3, 4, 5, 6, 7, 8, 9, A, B, C, D, E, and F.

Base 2 (binary) numbers are represented by a string of 1s and 0s, sometimes followed by the character B (for example, 1010B). The "B" designation is only used in situations where confusion as to the type of number might arise.

### 1.3.5 Segmented Addressing

The processor uses byte addressing. This means memory is organized and accessed as a sequence of bytes. Whether one or more bytes are being accessed, a byte address is used to locate the byte or bytes in memory. The range of memory that can be addressed is called an address space.

The processor also supports segmented addressing. This is a form of addressing where a program may have many independent address spaces, called segments. For example, a program can keep its code (instructions) and stack in separate segments. Code addresses would always refer to the code space, and stack addresses would always refer to the stack space. The following notation is used to specify a byte address within a segment:

```
Segment-register:Byte-address
```

For example, the following segment address identifies the byte at address FF79H in the segment pointed by the DS register:

```
DS:FF79H
```

The following segment address identifies an instruction address in the code segment. The CS register points to the code segment and the EIP register contains the address of the instruction.

```
CS:EIP
```

### 1.3.6 Exceptions

An exception is an event that typically occurs when an instruction causes an error. For example, an attempt to divide by zero generates an exception. However, some exceptions, such as breakpoints, occur under other conditions. Some types of exceptions may provide error codes. An error code reports additional information about the error. An example of the notation used to show an exception and error code is shown below:

```
#PF(fault code)
```

This example refers to a page-fault exception under conditions where an error code naming a type of fault is reported. Under some conditions, exceptions which produce error codes may not be able to report an accurate code. In this case, the error code is zero, as shown below for a general-protection exception:

```
#GP(0)
```

### 1.3.7 A New Syntax for CPUID, CR, and MSR Values

Obtain feature flags, status, and system information by using the CPUID instruction, by checking control register bits, and by reading model-specific registers. We are moving toward a new syntax to represent this information. See Figure 1-2.



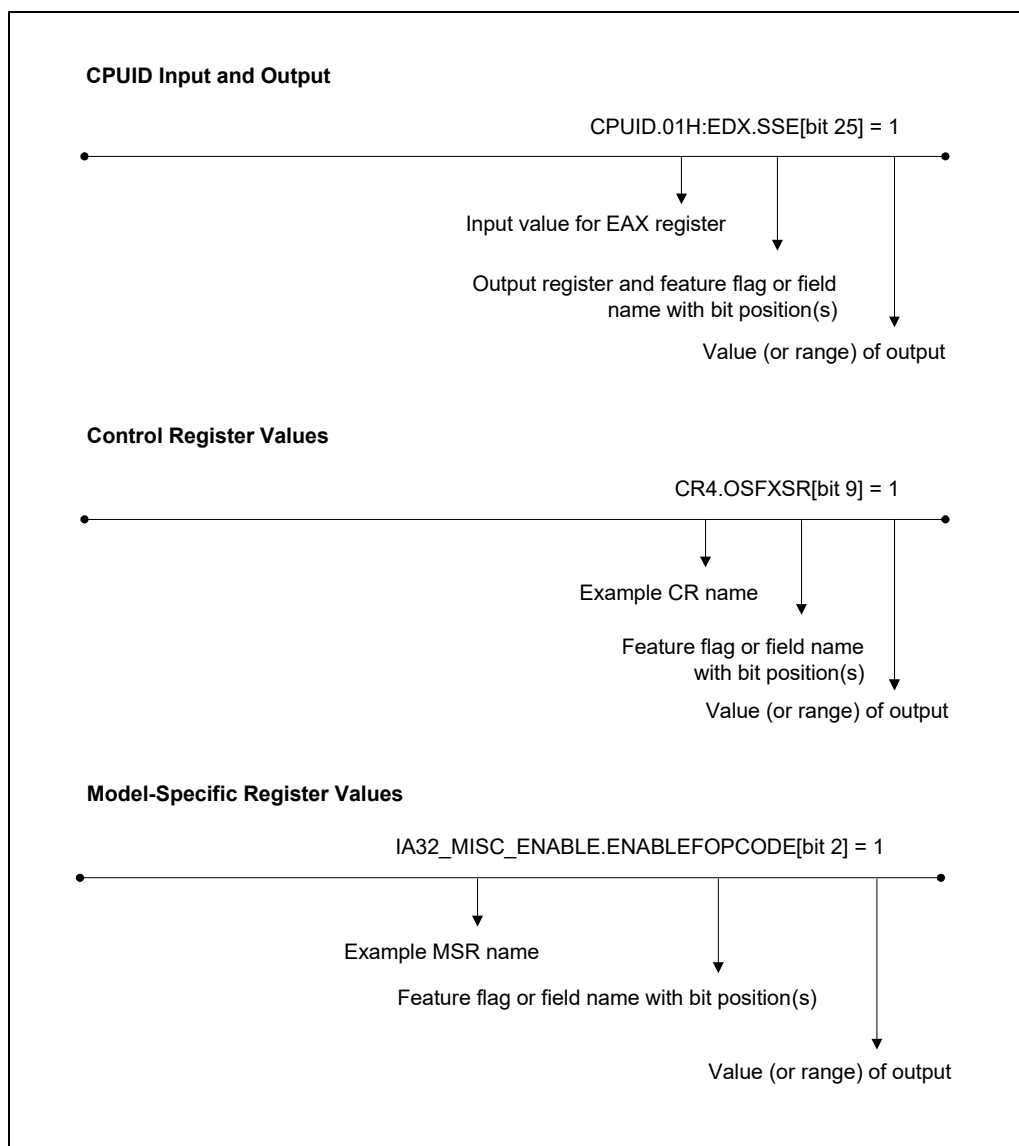

Figure 1-2. Syntax for CPUID, CR, and MSR Data Presentation

## 1.4 RELATED LITERATURE

Literature related to Intel 64 and IA-32 processors is listed and viewable on-line at:

<http://www.intel.com/content/www/us/en/processors/architectures-software-developer-manuals.html>

See also:

- The data sheet for a particular Intel 64 or IA-32 processor
- The specification update for a particular Intel 64 or IA-32 processor
- Intel® C++ Compiler documentation and online help:  
<http://software.intel.com/en-us/articles/intel-compilers/>
- Intel® Fortran Compiler documentation and online help:  
<http://software.intel.com/en-us/articles/intel-compilers/>
- Intel® Software Development Tools:  
<https://software.intel.com/en-us/intel-sdp-home>

## ABOUT THIS MANUAL

- Intel® 64 and IA-32 Architectures Software Developer's Manual (in one, four or ten volumes):  
<https://software.intel.com/en-us/articles/intel-sdm>
- Intel® 64 and IA-32 Architectures Optimization Reference Manual:  
<https://software.intel.com/en-us/articles/intel-sdm#optimization>
- Intel 64 Architecture x2APIC Specification:  
<http://www.intel.com/content/www/us/en/architecture-and-technology/64-architecture-x2apic-specification.html>
- Intel® Trusted Execution Technology Measured Launched Environment Programming Guide:  
<http://www.intel.com/content/www/us/en/software-developers/intel-txt-software-development-guide.html>
- Developing Multi-threaded Applications: A Platform Consistent Approach:  
<https://software.intel.com/sites/default/files/article/147714/51534-developing-multithreaded-applications.pdf>
- Using Spin-Loops on Intel® Pentium® 4 Processor and Intel® Xeon® Processor:  
<https://software.intel.com/sites/default/files/22/30/25602>
- Performance Monitoring Unit Sharing Guide  
<http://software.intel.com/file/30388>

Literature related to selected features in future Intel processors are available at:

- Intel® Architecture Instruction Set Extensions Programming Reference  
<https://software.intel.com/en-us/isa-extensions>
- Intel® Software Guard Extensions (Intel® SGX) Programming Reference  
<https://software.intel.com/en-us/isa-extensions/intel-sgx>

More relevant links are:

- Intel® Developer Zone:  
<https://software.intel.com/en-us>
- Developer centers:  
<http://www.intel.com/content/www/us/en/hardware-developers/developer-centers.html>
- Processor support general link:  
<http://www.intel.com/support/processors/>
- Intel® Hyper-Threading Technology (Intel® HT Technology):  
<http://www.intel.com/technology/platform-technology/hyper-threading/index.htm>

This chapter describes the instruction format for all Intel 64 and IA-32 processors. The instruction format for protected mode, real-address mode and virtual-8086 mode is described in Section 2.1. Increments provided for IA-32e mode and its sub-modes are described in Section 2.2.

## 2.1 INSTRUCTION FORMAT FOR PROTECTED MODE, REAL-ADDRESS MODE, AND VIRTUAL-8086 MODE

The Intel 64 and IA-32 architectures instruction encodings are subsets of the format shown in Figure 2-1. Instructions consist of optional instruction prefixes (in any order), primary opcode bytes (up to three bytes), an addressing-form specifier (if required) consisting of the ModR/M byte and sometimes the SIB (Scale-Index-Base) byte, a displacement (if required), and an immediate data field (if required).

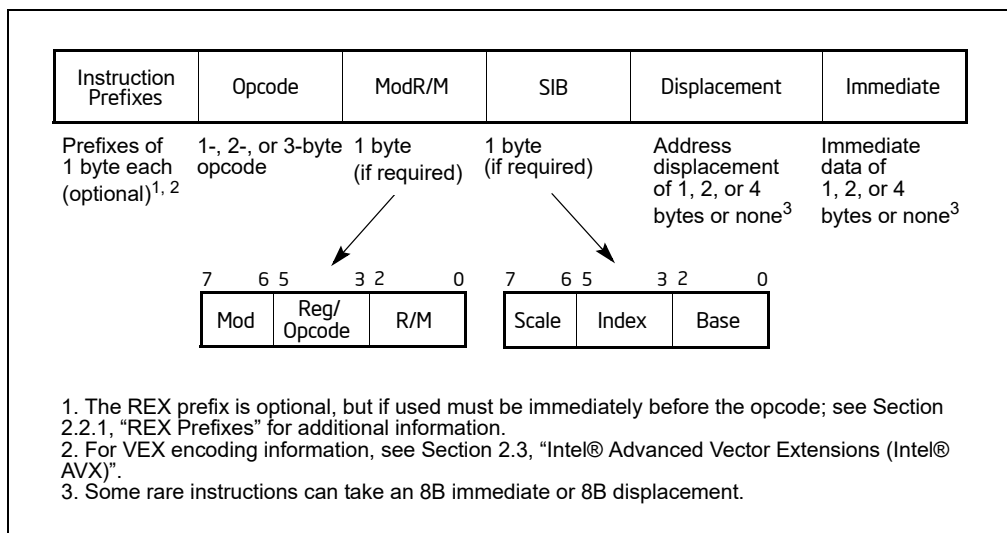

**Figure 2-1. Intel 64 and IA-32 Architectures Instruction Format**

### 2.1.1 Instruction Prefixes

Instruction prefixes are divided into four groups, each with a set of allowable prefix codes. For each instruction, it is only useful to include up to one prefix code from each of the four groups (Groups 1, 2, 3, 4). Groups 1 through 4 may be placed in any order relative to each other.

- Group 1
  - Lock and repeat prefixes:
    - LOCK prefix is encoded using F0H.
    - REPNE/REPZ prefix is encoded using F2H. Repeat-Not-Zero prefix applies only to string and input/output instructions. (F2H is also used as a mandatory prefix for some instructions.)
    - REP or REPE/REPZ is encoded using F3H. The repeat prefix applies only to string and input/output instructions. F3H is also used as a mandatory prefix for POPCNT, LZCNT and ADOX instructions.

## INSTRUCTION FORMAT

- BND prefix is encoded using F2H if the following conditions are true:
  - CPUID.(EAX=07H, ECX=0):EBX.MPX[bit 14] is set.
  - BNDCFGU.EN and/or IA32\_BNDCFGS.EN is set.
  - When the F2 prefix precedes a near CALL, a near RET, a near JMP, a short Jcc, or a near Jcc instruction (see Chapter 17, “Intel® MPX,” of the *Intel® 64 and IA-32 Architectures Software Developer’s Manual, Volume 1*).
- Group 2
  - Segment override prefixes:
    - 2EH—CS segment override (use with any branch instruction is reserved).
    - 36H—SS segment override prefix (use with any branch instruction is reserved).
    - 3EH—DS segment override prefix (use with any branch instruction is reserved).
    - 26H—ES segment override prefix (use with any branch instruction is reserved).
    - 64H—FS segment override prefix (use with any branch instruction is reserved).
    - 65H—GS segment override prefix (use with any branch instruction is reserved).
  - Branch hints<sup>1</sup>:
    - 2EH—Branch not taken (used only with Jcc instructions).
    - 3EH—Branch taken (used only with Jcc instructions).
- Group 3
  - Operand-size override prefix is encoded using 66H (66H is also used as a mandatory prefix for some instructions).
- Group 4
  - 67H—Address-size override prefix.

The LOCK prefix (F0H) forces an operation that ensures exclusive use of shared memory in a multiprocessor environment. See “LOCK—Assert LOCK# Signal Prefix” in Chapter 3, “Instruction Set Reference, A-L,” for a description of this prefix.

Repeat prefixes (F2H, F3H) cause an instruction to be repeated for each element of a string. Use these prefixes only with string and I/O instructions (MOVS, CMPS, SCAS, LODS, STOS, INS, and OUTS). Use of repeat prefixes and/or undefined opcodes with other Intel 64 or IA-32 instructions is reserved; such use may cause unpredictable behavior.

Some instructions may use F2H,F3H as a mandatory prefix to express distinct functionality.

Branch hint prefixes (2EH, 3EH) allow a program to give a hint to the processor about the most likely code path for a branch. Use these prefixes only with conditional branch instructions (Jcc). Other use of branch hint prefixes and/or other undefined opcodes with Intel 64 or IA-32 instructions is reserved; such use may cause unpredictable behavior.

The operand-size override prefix allows a program to switch between 16- and 32-bit operand sizes. Either size can be the default; use of the prefix selects the non-default size.

Some SSE2/SSE3/SSSE3/SSE4 instructions and instructions using a three-byte sequence of primary opcode bytes may use 66H as a mandatory prefix to express distinct functionality.

Other use of the 66H prefix is reserved; such use may cause unpredictable behavior.

The address-size override prefix (67H) allows programs to switch between 16- and 32-bit addressing. Either size can be the default; the prefix selects the non-default size. Using this prefix and/or other undefined opcodes when operands for the instruction do not reside in memory is reserved; such use may cause unpredictable behavior.

---

1. Some earlier microarchitectures used these as branch hints, but recent generations have not and they are reserved for future hint usage.

## 2.1.2 Opcodes

A primary opcode can be 1, 2, or 3 bytes in length. An additional 3-bit opcode field is sometimes encoded in the ModR/M byte. Smaller fields can be defined within the primary opcode. Such fields define the direction of operation, size of displacements, register encoding, condition codes, or sign extension. Encoding fields used by an opcode vary depending on the class of operation.

Two-byte opcode formats for general-purpose and SIMD instructions consist of one of the following:

- An escape opcode byte 0FH as the primary opcode and a second opcode byte.
- A mandatory prefix (66H, F2H, or F3H), an escape opcode byte, and a second opcode byte (same as previous bullet).

For example, CVTQ2PD consists of the following sequence: F3 0F E6. The first byte is a mandatory prefix (it is not considered as a repeat prefix).

Three-byte opcode formats for general-purpose and SIMD instructions consist of one of the following:

- An escape opcode byte 0FH as the primary opcode, plus two additional opcode bytes.
- A mandatory prefix (66H, F2H, or F3H), an escape opcode byte, plus two additional opcode bytes (same as previous bullet).

For example, PHADDW for XMM registers consists of the following sequence: 66 0F 38 01. The first byte is the mandatory prefix.

Valid opcode expressions are defined in Appendix A and Appendix B.

## 2.1.3 ModR/M and SIB Bytes

Many instructions that refer to an operand in memory have an addressing-form specifier byte (called the ModR/M byte) following the primary opcode. The ModR/M byte contains three fields of information:

- The *mod* field combines with the *r/m* field to form 32 possible values: eight registers and 24 addressing modes.
- The *reg/opcode* field specifies either a register number or three more bits of opcode information. The purpose of the *reg/opcode* field is specified in the primary opcode.
- The *r/m* field can specify a register as an operand or it can be combined with the *mod* field to encode an addressing mode. Sometimes, certain combinations of the *mod* field and the *r/m* field are used to express opcode information for some instructions.

Certain encodings of the ModR/M byte require a second addressing byte (the SIB byte). The base-plus-index and scale-plus-index forms of 32-bit addressing require the SIB byte. The SIB byte includes the following fields:

- The *scale* field specifies the scale factor.
- The *index* field specifies the register number of the index register.
- The *base* field specifies the register number of the base register.

See Section 2.1.5 for the encodings of the ModR/M and SIB bytes.

## 2.1.4 Displacement and Immediate Bytes

Some addressing forms include a displacement immediately following the ModR/M byte (or the SIB byte if one is present). If a displacement is required, it can be 1, 2, or 4 bytes.

If an instruction specifies an immediate operand, the operand always follows any displacement bytes. An immediate operand can be 1, 2 or 4 bytes.

### 2.1.5 Addressing-Mode Encoding of ModR/M and SIB Bytes

The values and corresponding addressing forms of the ModR/M and SIB bytes are shown in Table 2-1 through Table 2-3: 16-bit addressing forms specified by the ModR/M byte are in Table 2-1 and 32-bit addressing forms are in Table 2-2. Table 2-3 shows 32-bit addressing forms specified by the SIB byte. In cases where the reg/opcode field in the ModR/M byte represents an extended opcode, valid encodings are shown in Appendix B.

In Table 2-1 and Table 2-2, the Effective Address column lists 32 effective addresses that can be assigned to the first operand of an instruction by using the Mod and R/M fields of the ModR/M byte. The first 24 options provide ways of specifying a memory location; the last eight (Mod = 11B) provide ways of specifying general-purpose, MMX technology and XMM registers.

The Mod and R/M columns in Table 2-1 and Table 2-2 give the binary encodings of the Mod and R/M fields required to obtain the effective address listed in the first column. For example: see the row indicated by Mod = 11B, R/M = 000B. The row identifies the general-purpose registers EAX, AX or AL; MMX technology register MM0; or XMM register XMM0. The register used is determined by the opcode byte and the operand-size attribute.

Now look at the seventh row in either table (labeled "REG ="). This row specifies the use of the 3-bit Reg/Opcode field when the field is used to give the location of a second operand. The second operand must be a general-purpose, MMX technology, or XMM register. Rows one through five list the registers that may correspond to the value in the table. Again, the register used is determined by the opcode byte along with the operand-size attribute.

If the instruction does not require a second operand, then the Reg/Opcode field may be used as an opcode extension. This use is represented by the sixth row in the tables (labeled "/digit (Opcode)"). Note that values in row six are represented in decimal form.

The body of Table 2-1 and Table 2-2 (under the label "Value of ModR/M Byte (in Hexadecimal)") contains a 32 by 8 array that presents all of 256 values of the ModR/M byte (in hexadecimal). Bits 3, 4 and 5 are specified by the column of the table in which a byte resides. The row specifies bits 0, 1 and 2; and bits 6 and 7. The figure below demonstrates interpretation of one table value.

	Mod	11	
	RM		000
/digit (Opcode);	REG =	<b>001</b>	
	C8H	11	<b>001000</b>

**Figure 2-2. Table Interpretation of ModR/M Byte (C8H)**

Table 2-1. 16-Bit Addressing Forms with the ModR/M Byte

			AL AX EAX	CL CX ECX	DL DX EDX	BL BX EBX	AH SP ESP	CH BP <sup>1</sup> EBP	DH SI ESI	BH DI EDI
r8(/r)			MM0	MM1	MM2	MM3	MM4	MM5	MM6	MM7
r16(/r)			XMM0	XMM1	XMM2	XMM3	XMM4	XMM5	XMM6	XMM7
r32(/r)			0	1	2	3	4	5	6	7
mm(/r)			000	001	010	011	100	101	110	111
xmm(/r)										
(In decimal) /digit (Opcode)										
(In binary) REG =										
Effective Address	Mod	R/M	Value of ModR/M Byte (in Hexadecimal)							
[BX+SI]	00	000	00	08	10	18	20	28	30	38
[BX+DI]		001	01	09	11	19	21	29	31	39
[BP+SI]		010	02	0A	12	1A	22	2A	32	3A
[BP+DI]		011	03	0B	13	1B	23	2B	33	3B
[SI]		100	04	0C	14	1C	24	2C	34	3C
[DI]		101	05	0D	15	1D	25	2D	35	3D
disp16 <sup>2</sup>		110	06	0E	16	1E	26	2E	36	3E
[BX]		111	07	0F	17	1F	27	2F	37	3F
[BX+SI]+disp8 <sup>3</sup>	01	000	40	48	50	58	60	68	70	78
[BX+DI]+disp8		001	41	49	51	59	61	69	71	79
[BP+SI]+disp8		010	42	4A	52	5A	62	6A	72	7A
[BP+DI]+disp8		011	43	4B	53	5B	63	6B	73	7B
[SI]+disp8		100	44	4C	54	5C	64	6C	74	7C
[DI]+disp8		101	45	4D	55	5D	65	6D	75	7D
[BP]+disp8		110	46	4E	56	5E	66	6E	76	7E
[BX]+disp8		111	47	4F	57	5F	67	6F	77	7F
[BX+SI]+disp16	10	000	80	88	90	98	A0	A8	B0	B8
[BX+DI]+disp16		001	81	89	91	99	A1	A9	B1	B9
[BP+SI]+disp16		010	82	8A	92	9A	A2	AA	B2	BA
[BP+DI]+disp16		011	83	8B	93	9B	A3	AB	B3	BB
[SI]+disp16		100	84	8C	94	9C	A4	AC	B4	BC
[DI]+disp16		101	85	8D	95	9D	A5	AD	B5	BD
[BP]+disp16		110	86	8E	96	9E	A6	AE	B6	BE
[BX]+disp16		111	87	8F	97	9F	A7	AF	B7	BF
EAX/AX/AL/MM0/XMM0	11	000	C0	C8	D0	D8	E0	E8	F0	F8
ECX/CX/CL/MM1/XMM1		001	C1	C9	D1	D9	E1	E9	F1	F9
EDX/DX/DL/MM2/XMM2		010	C2	CA	D2	DA	E2	EA	F2	FA
EBX/BX/BL/MM3/XMM3		011	C3	CB	D3	DB	E3	EB	F3	FB
ESP/SP/AH/MM4/XMM4		100	C4	CC	D4	DC	E4	EC	F4	FC
EBP/BP/CH/MM5/XMM5		101	C5	CD	D5	DD	E5	ED	F5	FD
ESI/SI/DH/MM6/XMM6		110	C6	CE	D6	DE	E6	EE	F6	FE
EDI/DI/BH/MM7/XMM7		111	C7	CF	D7	DF	E7	EF	F7	FF

**NOTES:**

1. The default segment register is SS for the effective addresses containing a BP index, DS for other effective addresses.
2. The disp16 nomenclature denotes a 16-bit displacement that follows the ModR/M byte and that is added to the index.
3. The disp8 nomenclature denotes an 8-bit displacement that follows the ModR/M byte and that is sign-extended and added to the index.

Table 2-2. 32-Bit Addressing Forms with the ModR/M Byte

r8(/r) r16(/r) r32(/r) mm(/r) xmm(/r) (In decimal) /digit (Opcode) (In binary) REG =	AL AX EAX	CL CX ECX	DL DX EDX	BL BX EBX	AH SP ESP	CH BP EBP	DH SI ESI	BH DI EDI		
	MM0 XMM0	MM1 XMM1	MM2 XMM2	MM3 XMM3	MM4 XMM4	MM5 XMM5	MM6 XMM6	MM7 XMM7		
	0 000	1 001	2 010	3 011	4 100	5 101	6 110	7 111		
Effective Address	Mod	R/M	Value of ModR/M Byte (in Hexadecimal)							
[EAX] [ECX] [EDX] [EBX] [--][--] <sup>1</sup> disp32 <sup>2</sup> [ESI] [EDI]	00	000 001 010 011 100 101 110 111	00 01 02 03 04 05 06 07	08 09 0A 0B 0C 0D 0E 0F	10 11 12 13 14 15 16 17	18 19 1A 1B 1C 1D 1E 1F	20 21 22 23 24 25 26 27	28 29 2A 2B 2C 2D 2E 2F	30 31 32 33 34 35 36 37	38 39 3A 3B 3C 3D 3E 3F
[EAX]+disp8 <sup>3</sup> [ECX]+disp8 [EDX]+disp8 [EBX]+disp8 [--][--]+disp8 [EBP]+disp8 [ESI]+disp8 [EDI]+disp8	01	000 001 010 011 100 101 110 111	40 41 42 43 44 45 46 47	48 49 4A 4B 4C 4D 4E 4F	50 51 52 53 54 55 56 57	58 59 5A 5B 5C 5D 5E 5F	60 61 62 63 64 65 66 67	68 69 6A 6B 6C 6D 6E 6F	70 71 72 73 74 75 76 77	78 79 7A 7B 7C 7D 7E 7F
[EAX]+disp32 [ECX]+disp32 [EDX]+disp32 [EBX]+disp32 [--][--]+disp32 [EBP]+disp32 [ESI]+disp32 [EDI]+disp32	10	000 001 010 011 100 101 110 111	80 81 82 83 84 85 86 87	88 89 8A 8B 8C 8D 8E 8F	90 91 92 93 94 95 96 97	98 99 9A 9B 9C 9D 9E 9F	A0 A1 A2 A3 A4 A5 A6 A7	A8 A9 AA AB AC AD AE AF	B0 B1 B2 B3 B4 B5 B6 B7	B8 B9 BA BB BC BD BE BF
EAX/AX/AL/MM0/XMM0 ECX/CX/CL/MM/XMM1 EDX/DX/DL/MM2/XMM2 EBX/BX/BL/MM3/XMM3 ESP/SP/AH/MM4/XMM4 EBP/BP/CH/MM5/XMM5 ESI/SI/DH/MM6/XMM6 EDI/DI/BH/MM7/XMM7	11	000 001 010 011 100 101 110 111	C0 C1 C2 C3 C4 C5 C6 C7	C8 C9 CA CB CC CD CE CF	D0 D1 D2 D3 D4 D5 D6 D7	D8 D9 DA DB DC DD DE DF	E0 E1 E2 E3 E4 E5 E6 E7	E8 E9 EA EB EC ED EE EF	F0 F1 F2 F3 F4 F5 F6 F7	F8 F9 FA FB FC FD FE FF

**NOTES:**

1. The [--][--] nomenclature means a SIB follows the ModR/M byte.
2. The disp32 nomenclature denotes a 32-bit displacement that follows the ModR/M byte (or the SIB byte if one is present) and that is added to the index.
3. The disp8 nomenclature denotes an 8-bit displacement that follows the ModR/M byte (or the SIB byte if one is present) and that is sign-extended and added to the index.

Table 2-3 is organized to give 256 possible values of the SIB byte (in hexadecimal). General purpose registers used as a base are indicated across the top of the table, along with corresponding values for the SIB byte’s base field. Table rows in the body of the table indicate the register used as the index (SIB byte bits 3, 4 and 5) and the scaling factor (determined by SIB byte bits 6 and 7).



Table 2-3. 32-Bit Addressing Forms with the SIB Byte

r32 (In decimal) Base = (In binary) Base =			EAX 0 000	ECX 1 001	EDX 2 010	EBX 3 011	ESP 4 100	[*] 5 101	ESI 6 110	EDI 7 111
Scaled Index	SS	Index	Value of SIB Byte (in Hexadecimal)							
[EAX] [ECX] [EDX] [EBX] none [EBP] [ESI] [EDI]	00	000 001 010 011 100 101 110 111	00 08 10 18 20 28 30 38	01 09 11 19 21 29 31 39	02 0A 12 1A 22 2A 32 3A	03 0B 13 1B 23 2B 33 3B	04 0C 14 1C 24 2C 34 3C	05 0D 15 1D 25 2D 35 3D	06 0E 16 1E 26 2E 36 3E	07 0F 17 1F 27 2F 37 3F
[EAX*2] [ECX*2] [EDX*2] [EBX*2] none [EBP*2] [ESI*2] [EDI*2]	01	000 001 010 011 100 101 110 111	40 48 50 58 60 68 70 78	41 49 51 59 61 69 71 79	42 4A 52 5A 62 6A 72 7A	43 4B 53 5B 63 6B 73 7B	44 4C 54 5C 64 6C 74 7C	45 4D 55 5D 65 6D 75 7D	46 4E 56 5E 66 6E 76 7E	47 4F 57 5F 67 6F 77 7F
[EAX*4] [ECX*4] [EDX*4] [EBX*4] none [EBP*4] [ESI*4] [EDI*4]	10	000 001 010 011 100 101 110 111	80 88 90 98 A0 A8 B0 B8	81 89 91 99 A1 A9 B1 B9	82 8A 92 9A A2 AA B2 BA	83 8B 93 9B A3 AB B3 BB	84 8C 94 9C A4 AC B4 BC	85 8D 95 9D A5 AD B5 BD	86 8E 96 9E A6 AE B6 BE	87 8F 97 9F A7 AF B7 BF
[EAX*8] [ECX*8] [EDX*8] [EBX*8] none [EBP*8] [ESI*8] [EDI*8]	11	000 001 010 011 100 101 110 111	C0 C8 D0 D8 E0 E8 F0 F8	C1 C9 D1 D9 E1 E9 F1 F9	C2 CA D2 DA E2 EA F2 FA	C3 CB D3 DB E3 EB F3 FB	C4 CC D4 DC E4 EC F4 FC	C5 CD D5 DD E5 ED F5 FD	C6 CE D6 DE E6 EE F6 FE	C7 CF D7 DF E7 EF F7 FF

**NOTES:**

- The [\*] nomenclature means a disp32 with no base if the MOD is 00B. Otherwise, [\*] means disp8 or disp32 + [EBP]. This provides the following address modes:

MOD bits    Effective Address

- 00            [scaled index] + disp32  
01            [scaled index] + disp8 + [EBP]  
10            [scaled index] + disp32 + [EBP]

## 2.2 IA-32E MODE

IA-32e mode has two sub-modes. These are:

- Compatibility Mode.** Enables a 64-bit operating system to run most legacy protected mode software unmodified.
- 64-Bit Mode.** Enables a 64-bit operating system to run applications written to access 64-bit address space.

## 2.2.1 REX Prefixes

REX prefixes are instruction-prefix bytes used in 64-bit mode. They do the following:

- Specify GPRs and SSE registers.
- Specify 64-bit operand size.
- Specify extended control registers.

Not all instructions require a REX prefix in 64-bit mode. A prefix is necessary only if an instruction references one of the extended registers or uses a 64-bit operand. If a REX prefix is used when it has no meaning, it is ignored.

Only one REX prefix is allowed per instruction. If used, the REX prefix byte must immediately precede the opcode byte or the escape opcode byte (0FH). When a REX prefix is used in conjunction with an instruction containing a mandatory prefix, the mandatory prefix must come before the REX so the REX prefix can be immediately preceding the opcode or the escape byte. For example, CVTDQ2PD with a REX prefix should have REX placed between F3 and 0F E6. Other placements are ignored. The instruction-size limit of 15 bytes still applies to instructions with a REX prefix. See Figure 2-3.

Legacy Prefixes	REX Prefix	Opcode	ModR/M	SIB	Displacement	Immediate
Grp 1, Grp 2, Grp 3, Grp 4 (optional)	(optional)	1-, 2-, or 3-byte opcode	1 byte (if required)	1 byte (if required)	Address displacement of 1, 2, or 4 bytes	Immediate data of 1, 2, or 4 bytes or none

Figure 2-3. Prefix Ordering in 64-bit Mode

### 2.2.1.1 Encoding

Intel 64 and IA-32 instruction formats specify up to three registers by using 3-bit fields in the encoding, depending on the format:

- ModR/M: the reg and r/m fields of the ModR/M byte.
- ModR/M with SIB: the reg field of the ModR/M byte, the base and index fields of the SIB (scale, index, base) byte.
- Instructions without ModR/M: the reg field of the opcode.

In 64-bit mode, these formats do not change. Bits needed to define fields in the 64-bit context are provided by the addition of REX prefixes.

### 2.2.1.2 More on REX Prefix Fields

REX prefixes are a set of 16 opcodes that span one row of the opcode map and occupy entries 40H to 4FH. These opcodes represent valid instructions (INC or DEC) in IA-32 operating modes and in compatibility mode. In 64-bit mode, the same opcodes represent the instruction prefix REX and are not treated as individual instructions.

The single-byte-opcode forms of the INC/DEC instructions are not available in 64-bit mode. INC/DEC functionality is still available using ModR/M forms of the same instructions (opcodes FF/0 and FF/1).

See Table 2-4 for a summary of the REX prefix format. Figure 2-4 through Figure 2-7 show examples of REX prefix fields in use. Some combinations of REX prefix fields are invalid. In such cases, the prefix is ignored. Some additional information follows:

- Setting REX.W can be used to determine the operand size but does not solely determine operand width. Like the 66H size prefix, 64-bit operand size override has no effect on byte-specific operations.
- For non-byte operations: if a 66H prefix is used with prefix (REX.W = 1), 66H is ignored.
- If a 66H override is used with REX and REX.W = 0, the operand size is 16 bits.

- REX.R modifies the ModR/M reg field when that field encodes a GPR, SSE, control or debug register. REX.R is ignored when ModR/M specifies other registers or defines an extended opcode.
- REX.X bit modifies the SIB index field.
- REX.B either modifies the base in the ModR/M r/m field or SIB base field; or it modifies the opcode reg field used for accessing GPRs.

**Table 2-4. REX Prefix Fields [BITS: 0100WRXB]**

Field Name	Bit Position	Definition
-	7:4	0100
W	3	0 = Operand size determined by CS.D 1 = 64 Bit Operand Size
R	2	Extension of the ModR/M reg field
X	1	Extension of the SIB index field
B	0	Extension of the ModR/M r/m field, SIB base field, or Opcode reg field

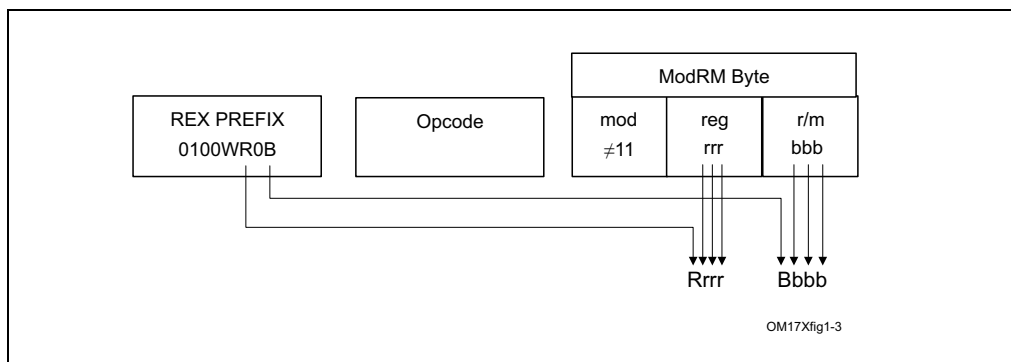

**Figure 2-4. Memory Addressing Without a SIB Byte; REX.X Not Used**

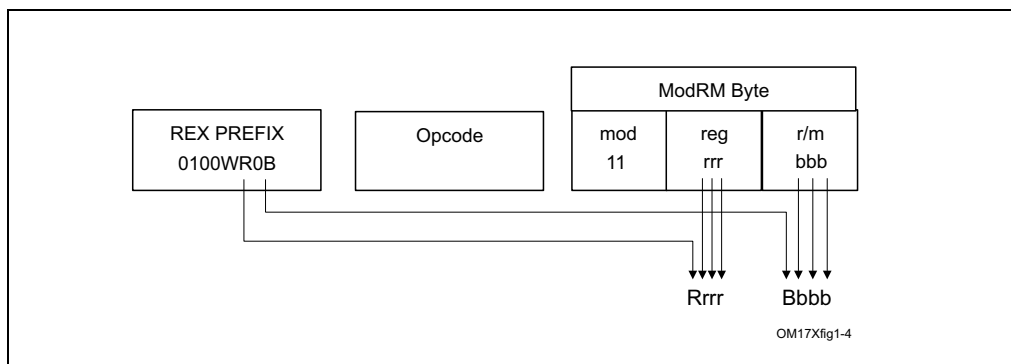

**Figure 2-5. Register-Register Addressing (No Memory Operand); REX.X Not Used**

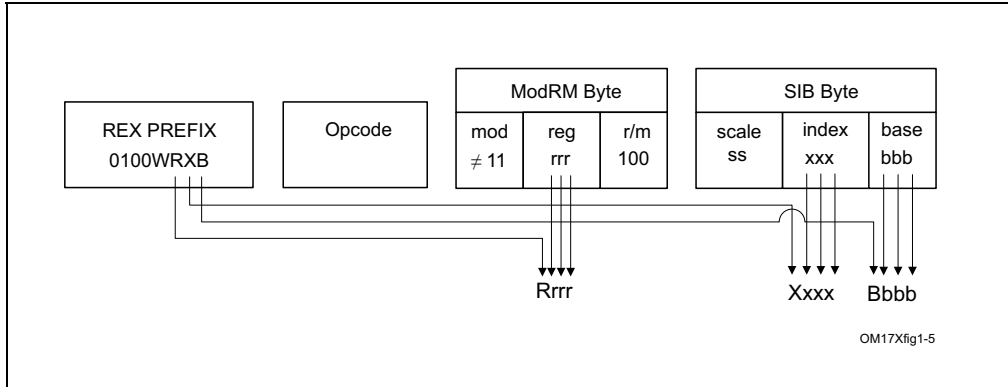

Figure 2-6. Memory Addressing With a SIB Byte

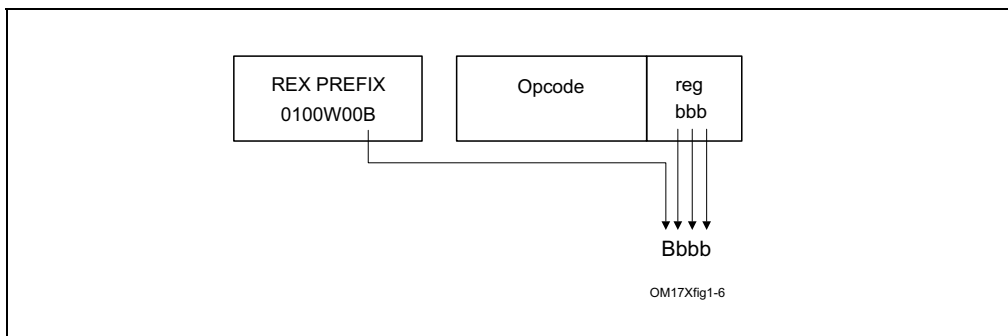

Figure 2-7. Register Operand Coded in Opcode Byte; REX.X & REX.R Not Used

In the IA-32 architecture, byte registers (AH, AL, BH, BL, CH, CL, DH, and DL) are encoded in the ModR/M byte’s reg field, the r/m field or the opcode reg field as registers 0 through 7. REX prefixes provide an additional addressing capability for byte-registers that makes the least-significant byte of GPRs available for byte operations. Certain combinations of the fields of the ModR/M byte and the SIB byte have special meaning for register encodings. For some combinations, fields expanded by the REX prefix are not decoded. Table 2-5 describes how each case behaves.

Table 2-5. Special Cases of REX Encodings

ModR/M or SIB	Sub-field Encodings	Compatibility Mode Operation	Compatibility Mode Implications	Additional Implications
ModR/M Byte	mod ≠ 11 r/m = b*100(ESP)	SIB byte present.	SIB byte required for ESP-based addressing.	REX prefix adds a fourth bit (b) which is not decoded (don't care). SIB byte also required for R12-based addressing.
ModR/M Byte	mod = 0 r/m = b*101(EBP)	Base register not used.	EBP without a displacement must be done using mod = 01 with displacement of 0.	REX prefix adds a fourth bit (b) which is not decoded (don't care). Using RBP or R13 without displacement must be done using mod = 01 with a displacement of 0.
SIB Byte	index = 0100(ESP)	Index register not used.	ESP cannot be used as an index register.	REX prefix adds a fourth bit (b) which is decoded. There are no additional implications. The expanded index field allows distinguishing RSP from R12, therefore R12 can be used as an index.
SIB Byte	base = 0101(EBP)	Base register is unused if mod = 0.	Base register depends on mod encoding.	REX prefix adds a fourth bit (b) which is not decoded. This requires explicit displacement to be used with EBP/RBP or R13.

**NOTES:**

\* Don't care about value of REX.B

### 2.2.1.3 Displacement

Addressing in 64-bit mode uses existing 32-bit ModR/M and SIB encodings. The ModR/M and SIB displacement sizes do not change. They remain 8 bits or 32 bits and are sign-extended to 64 bits.

### 2.2.1.4 Direct Memory-Offset MOVs

In 64-bit mode, direct memory-offset forms of the MOV instruction are extended to specify a 64-bit immediate absolute address. This address is called a moffset. No prefix is needed to specify this 64-bit memory offset. For these MOV instructions, the size of the memory offset follows the address-size default (64 bits in 64-bit mode). See Table 2-6.

Table 2-6. Direct Memory Offset Form of MOV

Opcode	Instruction
A0	MOV AL, moffset
A1	MOV EAX, moffset
A2	MOV moffset, AL
A3	MOV moffset, EAX

### 2.2.1.5 Immediates

In 64-bit mode, the typical size of immediate operands remains 32 bits. When the operand size is 64 bits, the processor sign-extends all immediates to 64 bits prior to their use.

Support for 64-bit immediate operands is accomplished by expanding the semantics of the existing move (MOV reg, imm16/32) instructions. These instructions (opcodes B8H – BFH) move 16-bits or 32-bits of immediate data (depending on the effective operand size) into a GPR. When the effective operand size is 64 bits, these instructions can be used to load an immediate into a GPR. A REX prefix is needed to override the 32-bit default operand size to a 64-bit operand size.

For example:

```
48 B8 8877665544332211 MOV RAX,1122334455667788H
```

### 2.2.1.6 RIP-Relative Addressing

A new addressing form, RIP-relative (relative instruction-pointer) addressing, is implemented in 64-bit mode. An effective address is formed by adding displacement to the 64-bit RIP of the next instruction.

In IA-32 architecture and compatibility mode, addressing relative to the instruction pointer is available only with control-transfer instructions. In 64-bit mode, instructions that use ModR/M addressing can use RIP-relative addressing. Without RIP-relative addressing, all ModR/M modes address memory relative to zero.

RIP-relative addressing allows specific ModR/M modes to address memory relative to the 64-bit RIP using a signed 32-bit displacement. This provides an offset range of  $\pm 2\text{GB}$  from the RIP. Table 2-7 shows the ModR/M and SIB encodings for RIP-relative addressing. Redundant forms of 32-bit displacement-addressing exist in the current ModR/M and SIB encodings. There is one ModR/M encoding and there are several SIB encodings. RIP-relative addressing is encoded using a redundant form.

In 64-bit mode, the ModR/M Disp32 (32-bit displacement) encoding is re-defined to be RIP+Disp32 rather than displacement-only. See Table 2-7.

**Table 2-7. RIP-Relative Addressing**

ModR/M and SIB Sub-field Encodings		Compatibility Mode Operation	64-bit Mode Operation	Additional Implications in 64-bit mode
ModR/M Byte	mod = 00	Disp32	RIP + Disp32	Must use SIB form with normal (zero-based) displacement addressing
	r/m = 101 (none)			
SIB Byte	base = 101 (none)	if mod = 00, Disp32	Same as legacy	None
	index = 100 (none)			
	scale = 0, 1, 2, 4			

The ModR/M encoding for RIP-relative addressing does not depend on using a prefix. Specifically, the r/m bit field encoding of 101B (used to select RIP-relative addressing) is not affected by the REX prefix. For example, selecting R13 (REX.B = 1, r/m = 101B) with mod = 00B still results in RIP-relative addressing. The 4-bit r/m field of REX.B combined with ModR/M is not fully decoded. In order to address R13 with no displacement, software must encode R13 + 0 using a 1-byte displacement of zero.

RIP-relative addressing is enabled by 64-bit mode, not by a 64-bit address-size. The use of the address-size prefix does not disable RIP-relative addressing. The effect of the address-size prefix is to truncate and zero-extend the computed effective address to 32 bits.

### 2.2.1.7 Default 64-Bit Operand Size

In 64-bit mode, two groups of instructions have a default operand size of 64 bits (do not need a REX prefix for this operand size). These are:

- Near branches.
- All instructions, except far branches, that implicitly reference the RSP.

## 2.2.2 Additional Encodings for Control and Debug Registers

In 64-bit mode, more encodings for control and debug registers are available. The REX.R bit is used to modify the ModR/M reg field when that field encodes a control or debug register (see Table 2-4). These encodings enable the processor to address CR8-CR15 and DR8-DR15. An additional control register (CR8) is defined in 64-bit mode. CR8 becomes the Task Priority Register (TPR).

In the first implementation of IA-32e mode, CR9-CR15 and DR8-DR15 are not implemented. Any attempt to access unimplemented registers results in an invalid-opcode exception (#UD).

## 2.3 INTEL® ADVANCED VECTOR EXTENSIONS (INTEL® AVX)

Intel AVX instructions are encoded using an encoding scheme that combines prefix bytes, opcode extension field, operand encoding fields, and vector length encoding capability into a new prefix, referred to as VEX. In the VEX encoding scheme, the VEX prefix may be two or three bytes long, depending on the instruction semantics. Despite the two-byte or three-byte length of the VEX prefix, the VEX encoding format provides a more compact representation/packing of the components of encoding an instruction in Intel 64 architecture. The VEX encoding scheme also allows more headroom for future growth of Intel 64 architecture.

### 2.3.1 Instruction Format

Instruction encoding using VEX prefix provides several advantages:

- Instruction syntax support for three operands and up-to four operands when necessary. For example, the third source register used by VBLENDVPD is encoded using bits 7:4 of the immediate byte.
- Encoding support for vector length of 128 bits (using XMM registers) and 256 bits (using YMM registers).
- Encoding support for instruction syntax of non-destructive source operands.
- Elimination of escape opcode byte (0FH), SIMD prefix byte (66H, F2H, F3H) via a compact bit field representation within the VEX prefix.
- Elimination of the need to use REX prefix to encode the extended half of general-purpose register sets (R8-R15) for direct register access, memory addressing, or accessing XMM8-XMM15 (including YMM8-YMM15).
- Flexible and more compact bit fields are provided in the VEX prefix to retain the full functionality provided by REX prefix. REX.W, REX.X, REX.B functionalities are provided in the three-byte VEX prefix only because only a subset of SIMD instructions need them.
- Extensibility for future instruction extensions without significant instruction length increase.

Figure 2-8 shows the Intel 64 instruction encoding format with VEX prefix support. Legacy instruction without a VEX prefix is fully supported and unchanged. The use of VEX prefix in an Intel 64 instruction is optional, but a VEX prefix is required for Intel 64 instructions that operate on YMM registers or support three and four operand syntax. VEX prefix is not a constant-valued, “single-purpose” byte like 0FH, 66H, F2H, F3H in legacy SSE instructions. VEX prefix provides substantially richer capability than the REX prefix.

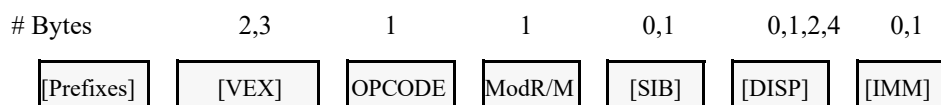

Figure 2-8. Instruction Encoding Format with VEX Prefix

### 2.3.2 VEX and the LOCK prefix

Any VEX-encoded instruction with a LOCK prefix preceding VEX will #UD.

### 2.3.3 VEX and the 66H, F2H, and F3H prefixes

Any VEX-encoded instruction with a 66H, F2H, or F3H prefix preceding VEX will #UD.

### 2.3.4 VEX and the REX prefix

Any VEX-encoded instruction with a REX prefix preceding VEX will #UD.

### 2.3.5 The VEX Prefix

The VEX prefix is encoded in either the two-byte form (the first byte must be C5H) or in the three-byte form (the first byte must be C4H). The two-byte VEX is used mainly for 128-bit, scalar, and the most common 256-bit AVX instructions; while the three-byte VEX provides a compact replacement of REX and 3-byte opcode instructions (including AVX and FMA instructions). Beyond the first byte of the VEX prefix, it consists of a number of bit fields providing specific capability, they are shown in Figure 2-9.

The bit fields of the VEX prefix can be summarized by its functional purposes:

- Non-destructive source register encoding (applicable to three and four operand syntax): This is the first source operand in the instruction syntax. It is represented by the notation, VEX.vvvv. This field is encoded using 1's complement form (inverted form), i.e. XMM0/YMM0/R0 is encoded as 1111B, XMM15/YMM15/R15 is encoded as 0000B.
- Vector length encoding: This 1-bit field represented by the notation VEX.L. L= 0 means vector length is 128 bits wide, L=1 means 256 bit vector. The value of this field is written as VEX.128 or VEX.256 in this document to distinguish encoded values of other VEX bit fields.
- REX prefix functionality: Full REX prefix functionality is provided in the three-byte form of VEX prefix. However the VEX bit fields providing REX functionality are encoded using 1's complement form, i.e. XMM0/YMM0/R0 is encoded as 1111B, XMM15/YMM15/R15 is encoded as 0000B.
  - Two-byte form of the VEX prefix only provides the equivalent functionality of REX.R, using 1's complement encoding. This is represented as VEX.R.
  - Three-byte form of the VEX prefix provides REX.R, REX.X, REX.B functionality using 1's complement encoding and three dedicated bit fields represented as VEX.R, VEX.X, VEX.B.
  - Three-byte form of the VEX prefix provides the functionality of REX.W only to specific instructions that need to override default 32-bit operand size for a general purpose register to 64-bit size in 64-bit mode. For those applicable instructions, VEX.W field provides the same functionality as REX.W. VEX.W field can provide completely different functionality for other instructions.

Consequently, the use of REX prefix with VEX encoded instructions is not allowed. However, the intent of the REX prefix for expanding register set is reserved for future instruction set extensions using VEX prefix encoding format.

- Compaction of SIMD prefix: Legacy SSE instructions effectively use SIMD prefixes (66H, F2H, F3H) as an opcode extension field. VEX prefix encoding allows the functional capability of such legacy SSE instructions (operating on XMM registers, bits 255:128 of corresponding YMM unmodified) to be encoded using the VEX.pp field without the presence of any SIMD prefix. The VEX-encoded 128-bit instruction will zero-out bits 255:128 of the destination register. VEX-encoded instruction may have 128 bit vector length or 256 bits length.
- Compaction of two-byte and three-byte opcode: More recently introduced legacy SSE instructions employ two and three-byte opcode. The one or two leading bytes are: 0FH, and 0FH 3AH/0FH 38H. The one-byte escape (0FH) and two-byte escape (0FH 3AH, 0FH 38H) can also be interpreted as an opcode extension field. The VEX.mmmmm field provides compaction to allow many legacy instruction to be encoded without the constant byte sequence, 0FH, 0FH 3AH, 0FH 38H. These VEX-encoded instruction may have 128 bit vector length or 256 bits length.

The VEX prefix is required to be the last prefix and immediately precedes the opcode bytes. It must follow any other prefixes. If VEX prefix is present a REX prefix is not supported.

The 3-byte VEX leaves room for future expansion with 3 reserved bits. REX and the 66h/F2h/F3h prefixes are reclaimed for future use.

VEX prefix has a two-byte form and a three byte form. If an instruction syntax can be encoded using the two-byte form, it can also be encoded using the three byte form of VEX. The latter increases the length of the instruction by one byte. This may be helpful in some situations for code alignment.

The VEX prefix supports 256-bit versions of floating-point SSE, SSE2, SSE3, and SSE4 instructions. Note, certain new instruction functionality can only be encoded with the VEX prefix.

The VEX prefix will #UD on any instruction containing MMX register sources or destinations.



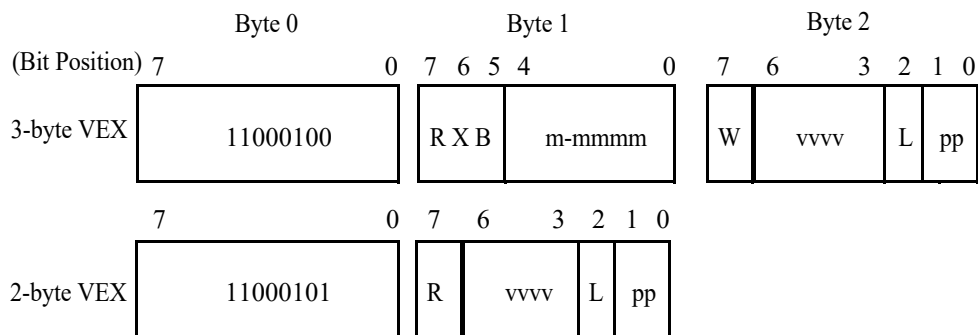

R: REX.R in 1's complement (inverted) form  
 1: Same as REX.R=0 (must be 1 in 32-bit mode)  
 0: Same as REX.R=1 (64-bit mode only)

X: REX.X in 1's complement (inverted) form  
 1: Same as REX.X=0 (must be 1 in 32-bit mode)  
 0: Same as REX.X=1 (64-bit mode only)

B: REX.B in 1's complement (inverted) form  
 1: Same as REX.B=0 (Ignored in 32-bit mode).  
 0: Same as REX.B=1 (64-bit mode only)

W: opcode specific (use like REX.W, or used for opcode extension, or ignored, depending on the opcode byte)

m-mmmm:  
 00000: Reserved for future use (will #UD)  
 00001: implied 0F leading opcode byte  
 00010: implied 0F 38 leading opcode bytes  
 00011: implied 0F 3A leading opcode bytes  
 00100-11111: Reserved for future use (will #UD)

vvvv: a register specifier (in 1's complement form) or 1111 if unused.

L: Vector Length  
 0: scalar or 128-bit vector  
 1: 256-bit vector

pp: opcode extension providing equivalent functionality of a SIMD prefix  
 00: None  
 01: 66  
 10: F3  
 11: F2

**Figure 2-9. VEX bit fields**

The following subsections describe the various fields in two or three-byte VEX prefix.

### 2.3.5.1 VEX Byte 0, bits[7:0]

VEX Byte 0, bits [7:0] must contain the value 11000101b (C5h) or 11000100b (C4h). The 3-byte VEX uses the C4h first byte, while the 2-byte VEX uses the C5h first byte.

### 2.3.5.2 VEX Byte 1, bit [7] - 'R'

VEX Byte 1, bit [7] contains a bit analogous to a bit inverted REX.R. In protected and compatibility modes the bit must be set to '1' otherwise the instruction is LES or LDS.

This bit is present in both 2- and 3-byte VEX prefixes.

The usage of WRXB bits for legacy instructions is explained in detail section 2.2.1.2 of Intel 64 and IA-32 Architectures Software developer's manual, Volume 2A.

This bit is stored in bit inverted format.

### 2.3.5.3 3-byte VEX byte 1, bit[6] - 'X'

Bit[6] of the 3-byte VEX byte 1 encodes a bit analogous to a bit inverted REX.X. It is an extension of the SIB Index field in 64-bit modes. In 32-bit modes, this bit must be set to '1' otherwise the instruction is LES or LDS.

This bit is available only in the 3-byte VEX prefix.

This bit is stored in bit inverted format.

### 2.3.5.4 3-byte VEX byte 1, bit[5] - 'B'

Bit[5] of the 3-byte VEX byte 1 encodes a bit analogous to a bit inverted REX.B. In 64-bit modes, it is an extension of the ModR/M r/m field, or the SIB base field. In 32-bit modes, this bit is ignored.

This bit is available only in the 3-byte VEX prefix.

This bit is stored in bit inverted format.

### 2.3.5.5 3-byte VEX byte 2, bit[7] - 'W'

Bit[7] of the 3-byte VEX byte 2 is represented by the notation VEX.W. It can provide following functions, depending on the specific opcode.

- For AVX instructions that have equivalent legacy SSE instructions (typically these SSE instructions have a general-purpose register operand with its operand size attribute promotable by REX.W), if REX.W promotes the operand size attribute of the general-purpose register operand in legacy SSE instruction, VEX.W has same meaning in the corresponding AVX equivalent form. In 32-bit modes for these instructions, VEX.W is silently ignored.
- For AVX instructions that have equivalent legacy SSE instructions (typically these SSE instructions have operands with their operand size attribute fixed and not promotable by REX.W), if REX.W is don't care in legacy SSE instruction, VEX.W is ignored in the corresponding AVX equivalent form irrespective of mode.
- For new AVX instructions where VEX.W has no defined function (typically these meant the combination of the opcode byte and VEX.mmmmm did not have any equivalent SSE functions), VEX.W is reserved as zero and setting to other than zero will cause instruction to #UD.

### 2.3.5.6 2-byte VEX Byte 1, bits[6:3] and 3-byte VEX Byte 2, bits [6:3]- 'vvvv' the Source or Dest Register Specifier

In 32-bit mode the VEX first byte C4 and C5 alias onto the LES and LDS instructions. To maintain compatibility with existing programs the VEX 2nd byte, bits [7:6] must be 11b. To achieve this, the VEX payload bits are selected to place only inverted, 64-bit valid fields (extended register selectors) in these upper bits.

The 2-byte VEX Byte 1, bits [6:3] and the 3-byte VEX, Byte 2, bits [6:3] encode a field (shorthand VEX.vvvv) that for instructions with 2 or more source registers and an XMM or YMM or memory destination encodes the first source register specifier stored in inverted (1's complement) form.

VEX.vvvv is not used by the instructions with one source (except certain shifts, see below) or on instructions with no XMM or YMM or memory destination. If an instruction does not use VEX.vvvv then it should be set to 1111b otherwise instruction will #UD.

In 64-bit mode all 4 bits may be used. See Table 2-8 for the encoding of the XMM or YMM registers. In 32-bit and 16-bit modes bit 6 must be 1 (if bit 6 is not 1, the 2-byte VEX version will generate LDS instruction and the 3-byte VEX version will ignore this bit).

**Table 2-8. VEX.vvvv to register name mapping**

VEX.vvvv	Dest Register	Valid in Legacy/Compatibility 32-bit modes?
1111B	XMM0/YMM0	Valid
1110B	XMM1/YMM1	Valid
1101B	XMM2/YMM2	Valid
1100B	XMM3/YMM3	Valid
1011B	XMM4/YMM4	Valid
1010B	XMM5/YMM5	Valid
1001B	XMM6/YMM6	Valid
1000B	XMM7/YMM7	Valid
0111B	XMM8/YMM8	Invalid
0110B	XMM9/YMM9	Invalid
0101B	XMM10/YMM10	Invalid
0100B	XMM11/YMM11	Invalid
0011B	XMM12/YMM12	Invalid
0010B	XMM13/YMM13	Invalid
0001B	XMM14/YMM14	Invalid
0000B	XMM15/YMM15	Invalid

The VEX.vvvv field is encoded in bit inverted format for accessing a register operand.

### 2.3.6 Instruction Operand Encoding and VEX.vvvv, ModR/M

VEX-encoded instructions support three-operand and four-operand instruction syntax. Some VEX-encoded instructions have syntax with less than three operands, e.g. VEX-encoded pack shift instructions support one source operand and one destination operand).

The roles of VEX.vvvv, reg field of ModR/M byte (ModR/M.reg), r/m field of ModR/M byte (ModR/M.r/m) with respect to encoding destination and source operands vary with different type of instruction syntax.

The role of VEX.vvvv can be summarized to three situations:

- VEX.vvvv encodes the first source register operand, specified in inverted (1's complement) form and is valid for instructions with 2 or more source operands.
- VEX.vvvv encodes the destination register operand, specified in 1's complement form for certain vector shifts. The instructions where VEX.vvvv is used as a destination are listed in Table 2-9. The notation in the "Opcode" column in Table 2-9 is described in detail in section 3.1.1.
- VEX.vvvv does not encode any operand, the field is reserved and should contain 1111b.

**Table 2-9. Instructions with a VEX.vvvv destination**

Opcode	Instruction mnemonic
VEX.NDD.128.66.0F 73 /7 ib	VPSLLDQ xmm1, xmm2, imm8
VEX.NDD.128.66.0F 73 /3 ib	VPSRLDQ xmm1, xmm2, imm8
VEX.NDD.128.66.0F 71 /2 ib	VPSRLW xmm1, xmm2, imm8
VEX.NDD.128.66.0F 72 /2 ib	VPSRLD xmm1, xmm2, imm8
VEX.NDD.128.66.0F 73 /2 ib	VPSRLQ xmm1, xmm2, imm8
VEX.NDD.128.66.0F 71 /4 ib	VPSRAW xmm1, xmm2, imm8
VEX.NDD.128.66.0F 72 /4 ib	VPSRAD xmm1, xmm2, imm8
VEX.NDD.128.66.0F 71 /6 ib	VPSLLW xmm1, xmm2, imm8
VEX.NDD.128.66.0F 72 /6 ib	VPSLLD xmm1, xmm2, imm8
VEX.NDD.128.66.0F 73 /6 ib	VPSLLQ xmm1, xmm2, imm8

The role of ModR/M.r/m field can be summarized to two situations:

- ModR/M.r/m encodes the instruction operand that references a memory address.
- For some instructions that do not support memory addressing semantics, ModR/M.r/m encodes either the destination register operand or a source register operand.

The role of ModR/M.reg field can be summarized to two situations:

- ModR/M.reg encodes either the destination register operand or a source register operand.
- For some instructions, ModR/M.reg is treated as an opcode extension and not used to encode any instruction operand.

For instruction syntax that support four operands, VEX.vvvv, ModR/M.r/m, ModR/M.reg encodes three of the four operands. The role of bits 7:4 of the immediate byte serves the following situation:

- Imm8[7:4] encodes the third source register operand.

### 2.3.6.1 3-byte VEX byte 1, bits[4:0] - “m-mmmm”

Bits[4:0] of the 3-byte VEX byte 1 encode an implied leading opcode byte (0F, 0F 38, or 0F 3A). Several bits are reserved for future use and will #UD unless 0.

**Table 2-10. VEX.m-mmmm interpretation**

VEX.m-mmmm	Implied Leading Opcode Bytes
00000B	Reserved
00001B	0F
00010B	0F 38
00011B	0F 3A
00100-11111B	Reserved
(2-byte VEX)	0F

VEX.m-mmmm is only available on the 3-byte VEX. The 2-byte VEX implies a leading 0Fh opcode byte.

### 2.3.6.2 2-byte VEX byte 1, bit[2], and 3-byte VEX byte 2, bit [2]- “L”

The vector length field, VEX.L, is encoded in bit[2] of either the second byte of 2-byte VEX, or the third byte of 3-byte VEX. If “VEX.L = 1”, it indicates 256-bit vector operation. “VEX.L = 0” indicates scalar and 128-bit vector operations.

The instruction VZEROUPPER is a special case that is encoded with VEX.L = 0, although its operation zero’s bits 255:128 of all YMM registers accessible in the current operating mode.

See the following table.

**Table 2-11. VEX.L interpretation**

VEX.L	Vector Length
0	128-bit (or 32/64-bit scalar)
1	256-bit

### 2.3.6.3 2-byte VEX byte 1, bits[1:0], and 3-byte VEX byte 2, bits [1:0]- “pp”

Up to one implied prefix is encoded by bits[1:0] of either the 2-byte VEX byte 1 or the 3-byte VEX byte 2. The prefix behaves as if it was encoded prior to VEX, but after all other encoded prefixes.

See the following table.

Table 2-12. VEX.pp interpretation

pp	Implies this prefix after other prefixes but before VEX
00B	None
01B	66
10B	F3
11B	F2

### 2.3.7 The Opcode Byte

One (and only one) opcode byte follows the 2 or 3 byte VEX. Legal opcodes are specified in Appendix B, in color. Any instruction that uses illegal opcode will #UD.

### 2.3.8 The MODRM, SIB, and Displacement Bytes

The encodings are unchanged but the interpretation of reg\_field or rm\_field differs (see above).

### 2.3.9 The Third Source Operand (Immediate Byte)

VEX-encoded instructions can support instruction with a four operand syntax. VBLENDVPD, VBLENDVPS, and PBLENDVB use imm8[7:4] to encode one of the source registers.

### 2.3.10 AVX Instructions and the Upper 128-bits of YMM registers

If an instruction with a destination XMM register is encoded with a VEX prefix, the processor zeroes the upper bits (above bit 128) of the equivalent YMM register. Legacy SSE instructions without VEX preserve the upper bits.

#### 2.3.10.1 Vector Length Transition and Programming Considerations

An instruction encoded with a VEX.128 prefix that loads a YMM register operand operates as follows:

- Data is loaded into bits 127:0 of the register
- Bits above bit 127 in the register are cleared.

Thus, such an instruction clears bits 255:128 of a destination YMM register on processors with a maximum vector-register width of 256 bits. In the event that future processors extend the vector registers to greater widths, an instruction encoded with a VEX.128 or VEX.256 prefix will also clear any bits beyond bit 255. (This is in contrast with legacy SSE instructions, which have no VEX prefix; these modify only bits 127:0 of any destination register operand.)

Programmers should bear in mind that instructions encoded with VEX.128 and VEX.256 prefixes will clear any future extensions to the vector registers. A calling function that uses such extensions should save their state before calling legacy functions. This is not possible for involuntary calls (e.g., into an interrupt-service routine). It is recommended that software handling involuntary calls accommodate this by not executing instructions encoded with VEX.128 and VEX.256 prefixes. In the event that it is not possible or desirable to restrict these instructions, then software must take special care to avoid actions that would, on future processors, zero the upper bits of vector registers.

Processors that support further vector-register extensions (defining bits beyond bit 255) will also extend the XSAVE and XRSTOR instructions to save and restore these extensions. To ensure forward compatibility, software that handles involuntary calls and that uses instructions encoded with VEX.128 and VEX.256 prefixes should first save and then restore the vector registers (with any extensions) using the XSAVE and XRSTOR instructions with save/restore masks that set bits that correspond to all vector-register extensions. Ideally, software should rely on a mechanism that is cognizant of which bits to set. (E.g., an OS mechanism that sets the save/restore mask bits for all vector-register extensions that are enabled in XCR0.) Saving and restoring state with instructions other than XSAVE and XRSTOR will, on future processors with wider vector registers, corrupt the extended state of the vector registers - even if doing so functions correctly on processors supporting 256-bit vector registers. (The same is true

if XSAVE and XRSTOR are used with a save/restore mask that does not set bits corresponding to all supported extensions to the vector registers.)

### 2.3.11 AVX Instruction Length

The AVX instructions described in this document (including VEX and ignoring other prefixes) do not exceed 11 bytes in length, but may increase in the future. The maximum length of an Intel 64 and IA-32 instruction remains 15 bytes.

### 2.3.12 Vector SIB (VSIB) Memory Addressing

In Intel® Advanced Vector Extensions 2 (Intel® AVX2), an SIB byte that follows the ModR/M byte can support VSIB memory addressing to an array of linear addresses. VSIB addressing is only supported in a subset of Intel AVX2 instructions. VSIB memory addressing requires 32-bit or 64-bit effective address. In 32-bit mode, VSIB addressing is not supported when address size attribute is overridden to 16 bits. In 16-bit protected mode, VSIB memory addressing is permitted if address size attribute is overridden to 32 bits. Additionally, VSIB memory addressing is supported only with VEX prefix.

In VSIB memory addressing, the SIB byte consists of:

- The scale field (bit 7:6) specifies the scale factor.
- The index field (bits 5:3) specifies the register number of the vector index register, each element in the vector register specifies an index.
- The base field (bits 2:0) specifies the register number of the base register.

Table 2-3 shows the 32-bit VSIB addressing form. It is organized to give 256 possible values of the SIB byte (in hexadecimal). General purpose registers used as a base are indicated across the top of the table, along with corresponding values for the SIB byte's base field. The register names also include R8L-R15L applicable only in 64-bit mode (when address size override prefix is used, but the value of VEX.B is not shown in Table 2-3). In 32-bit mode, R8L-R15L does not apply.

Table rows in the body of the table indicate the vector index register used as the index field and each supported scaling factor shown separately. Vector registers used in the index field can be XMM or YMM registers. The left-most column includes vector registers VR8-VR15 (i.e. XMM8/YMM8-XMM15/YMM15), which are only available in 64-bit mode and does not apply if encoding in 32-bit mode.

**Table 2-13. 32-Bit VSIB Addressing Forms of the SIB Byte**

r32			EAX/ R8L	ECX/ R9L	EDX/ R10L	EBX/ R11L	ESP/ R12L	EBP/ R13L <sup>1</sup>	ESI/ R14L	EDI/ R15L	
(In decimal) Base =			0	1	2	3	4	5	6	7	
(In binary) Base =			000	001	010	011	100	101	110	111	
Scaled Index	SS	Index	Value of SIB Byte (in Hexadecimal)								
VR0/VR8	*1	00	000	00	01	02	03	04	05	06	07
VR1/VR9			001	08	09	0A	0B	0C	0D	0E	0F
VR2/VR10			010	10	11	12	13	14	15	16	17
VR3/VR11			011	18	19	1A	1B	1C	1D	1E	1F
VR4/VR12			100	20	21	22	23	24	25	26	27
VR5/VR13			101	28	29	2A	2B	2C	2D	2E	2F
VR6/VR14			110	30	31	32	33	34	35	36	37
VR7/VR15			111	38	39	3A	3B	3C	3D	3E	3F
VR0/VR8	*2	01	000	40	41	42	43	44	45	46	47
VR1/VR9			001	48	49	4A	4B	4C	4D	4E	4F
VR2/VR10			010	50	51	52	53	54	55	56	57
VR3/VR11			011	58	59	5A	5B	5C	5D	5E	5F
VR4/VR12			100	60	61	62	63	64	65	66	67
VR5/VR13			101	68	69	6A	6B	6C	6D	6E	6F
VR6/VR14			110	70	71	72	73	74	75	76	77
VR7/VR15			111	78	79	7A	7B	7C	7D	7E	7F

Table 2-13. 32-Bit VSIB Addressing Forms of the SIB Byte (Contd.)

VR0/VR8	*4	10	000	80	81	82	83	84	85	86	87
VR1/VR9			001	88	89	8A	8B	8C	8D	8E	8F
VR2/VR10			010	90	91	92	93	94	95	96	97
VR3/VR11			011	98	99	9A	9B	9C	9D	9E	9F
VR4/VR12			100	A0	A1	A2	A3	A4	A5	A6	A7
VR5/VR13			101	A8	A9	AA	AB	AC	AD	AE	AF
VR6/VR14			110	B0	B1	B2	B3	B4	B5	B6	B7
VR7/VR15			111	B8	B9	BA	BB	BC	BD	BE	BF
VR0/VR8	*8	11	000	C0	C1	C2	C3	C4	C5	C6	C7
VR1/VR9			001	C8	C9	CA	CB	CC	CD	CE	CF
VR2/VR10			010	D0	D1	D2	D3	D4	D5	D6	D7
VR3/VR11			011	D8	D9	DA	DB	DC	DD	DE	DF
VR4/VR12			100	E0	E1	E2	E3	E4	E5	E6	E7
VR5/VR13			101	E8	E9	EA	EB	EC	ED	EE	EF
VR6/VR14			110	F0	F1	F2	F3	F4	F5	F6	F7
VR7/VR15			111	F8	F9	FA	FB	FC	FD	FE	FF

**NOTES:**

1. If ModR/M.mod = 00b, the base address is zero, then effective address is computed as [scaled vector index] + disp32. Otherwise the base address is computed as [EBP/R13]+ disp, the displacement is either 8 bit or 32 bit depending on the value of ModR/M.mod:

MOD	Effective Address
00b	[Scaled Vector Register] + Disp32
01b	[Scaled Vector Register] + Disp8 + [EBP/R13]
10b	[Scaled Vector Register] + Disp32 + [EBP/R13]

**2.3.12.1 64-bit Mode VSIB Memory Addressing**

In 64-bit mode VSIB memory addressing uses the VEX.B field and the base field of the SIB byte to encode one of the 16 general-purpose register as the base register. The VEX.X field and the index field of the SIB byte encode one of the 16 vector registers as the vector index register.

In 64-bit mode the top row of Table 2-13 base register should be interpreted as the full 64-bit of each register.

**2.4 AVX AND SSE INSTRUCTION EXCEPTION SPECIFICATION**

To look up the exceptions of legacy 128-bit SIMD instruction, 128-bit VEX-encoded instructions, and 256-bit VEX-encoded instruction, Table 2-14 summarizes the exception behavior into separate classes, with detailed exception conditions defined in sub-sections 2.4.1 through 2.5.1. For example, ADDPS contains the entry:

“See Exceptions Type 2”

In this entry, “Type2” can be looked up in Table 2-14.

The instruction’s corresponding CPUID feature flag can be identified in the fourth column of the Instruction summary table.

Note: #UD on CPUID feature flags=0 is not guaranteed in a virtualized environment if the hardware supports the feature flag.

**NOTE**

Instructions that operate only with MMX, X87, or general-purpose registers are not covered by the exception classes defined in this section. For instructions that operate on MMX registers, see Section 22.25.3, “Exception Conditions of Legacy SIMD Instructions Operating on MMX Registers” in the *Intel® 64 and IA-32 Architectures Software Developer’s Manual, Volume 3B*.

**Table 2-14. Exception class description**

Exception Class	Instruction set	Mem arg	Floating-Point Exceptions (#XM)
Type 1	AVX, Legacy SSE	16/32 byte explicitly aligned	None
Type 2	AVX, Legacy SSE	16/32 byte not explicitly aligned	Yes
Type 3	AVX, Legacy SSE	< 16 byte	Yes
Type 4	AVX, Legacy SSE	16/32 byte not explicitly aligned	No
Type 5	AVX, Legacy SSE	< 16 byte	No
Type 6	AVX (no Legacy SSE)	Varies	(At present, none do)
Type 7	AVX, Legacy SSE	None	None
Type 8	AVX	None	None
Type 11	F16C	8 or 16 byte, Not explicitly aligned, no AC#	Yes
Type 12	AVX2	Not explicitly aligned, no AC#	No

See Table 2-15 for lists of instructions in each exception class.



Table 2-15. Instructions in each Exception Class

Exception Class	Instruction
Type 1	(V)MOVAPD, (V)MOVAPS, (V)MOVDDQA, (V)MOVNTDQ, (V)MOVNTDQA, (V)MOVNTPD, (V)MOVNTPS
Type 2	(V)ADDPD, (V)ADDPs, (V)ADDSUBPD, (V)ADDSUBPS, (V)CMPPD, (V)CMPPS, (V)CVTDQ2PS, (V)CVTPD2DQ, (V)CVTPD2PS, (V)CVTPS2DQ, (V)CVTTPD2DQ, (V)CVTTPS2DQ, (V)DIVPD, (V)DIVPS, (V)DPPD*, (V)DPPS*, (V)FMADD132PD, (V)FMADD213PD, (V)FMADD231PD, (V)FMADD132PS, (V)FMADD213PS, (V)FMADD231PS, (V)FMADDSUB132PD, (V)FMADDSUB213PD, (V)FMADDSUB231PD, (V)FMADDSUB132PS, (V)FMADDSUB213PS, (V)FMADDSUB231PS, (V)FMSUBADD132PD, (V)FMSUBADD213PD, (V)FMSUBADD231PD, (V)FMSUBADD132PS, (V)FMSUBADD213PS, (V)FMSUBADD231PS, (V)FMSUB132PD, (V)FMSUB213PD, (V)FMSUB231PD, (V)FMSUB132PS, (V)FMSUB213PS, (V)FMSUB231PS, (V)FNMADD132PD, (V)FNMADD213PD, (V)FNMADD231PD, (V)FNMADD132PS, (V)FNMADD213PS, (V)FNMADD231PS, (V)FNMMSUB132PD, (V)FNMMSUB213PD, (V)FNMMSUB231PD, (V)FNMMSUB132PS, (V)FNMMSUB213PS, (V)FNMMSUB231PS, (V)HADDPD, (V)HADDPs, (V)HADDPS, (V)HSUBPD, (V)HSUBPS, (V)MAXPD, (V)MAXPS, (V)MINPD, (V)MINPS, (V)MULPD, (V)MULPS, (V)ROUNDPS, (V)SQRTPD, (V)SQRTPS, (V)SUBPD, (V)SUBPS
Type 3	(V)ADDS, (V)ADDSs, (V)CMPD, (V)CMPs, (V)COMISD, (V)COMISS, (V)CVTSD2PS, (V)CVTSD2SI, (V)CVTSD2SS, (V)CVTSD2SD, (V)CVTSD2SS, (V)CVTSS2SD, (V)CVTSS2SI, (V)CVTSS2SI, (V)CVTSS2SI, (V)DIVSD, (V)DIVSS, (V)FMADD132SD, (V)FMADD213SD, (V)FMADD231SD, (V)FMADD132SS, (V)FMADD213SS, (V)FMADD231SS, (V)FMSUB132SD, (V)FMSUB213SD, (V)FMSUB231SD, (V)FMSUB132SS, (V)FMSUB213SS, (V)FMSUB231SS, (V)FNMADD132SD, (V)FNMADD213SD, (V)FNMADD231SD, (V)FNMADD132SS, (V)FNMADD213SS, (V)FNMADD231SS, (V)FNMMSUB132SD, (V)FNMMSUB213SD, (V)FNMMSUB231SD, (V)FNMMSUB132SS, (V)FNMMSUB213SS, (V)FNMMSUB231SS, (V)MAXSD, (V)MAXSS, (V)MINS, (V)MINSs, (V)MULSD, (V)MULSS, (V)ROUNDSD, (V)ROUNDSS, (V)SQRTSD, (V)SQRTSS, (V)SUBSD, (V)SUBSS, (V)UCOMISD, (V)UCOMISS
Type 4	(V)AESDEC, (V)AESDECLAST, (V)AESENC, (V)AESENCLAST, (V)AESIMC, (V)AESKEYGENASSIST, (V)ANDPD, (V)ANDPS, (V)ANDNPD, (V)ANDNPS, (V)BLENDPD, (V)BLENDPS, (V)BLENDVPD, (V)BLENDVPS, (V)LDDQU***, (V)MASKMOVDQU, (V)PTEST, (V)TESTPS, (V)TESTPD, (V)MOVDQU*, (V)MOVSHDUP, (V)MOVSLDUP, (V)MOVUPD*, (V)MOVUPS*, (V)MPSADBW, (V)ORPD, (V)ORPS, (V)PABSB, (V)PABSW, (V)PABSD, (V)PACKSSWB, (V)PACKSSDW, (V)PACKUSWB, (V)PACKUSDW, (V)PADDB, (V)PADDW, (V)PADDD, (V)PADDQ, (V)PADDSB, (V)PADDSW, (V)PADDUSB, (V)PADDUSW, (V)PALIGNR, (V)PAND, (V)PANDN, (V)PAVGB, (V)PAVGW, (V)PBLENDVB, (V)PBLENDW, (V)PCMP(E/I)STRI/M***, (V)PCMPEQB, (V)PCMPEQW, (V)PCMPEQD, (V)PCMPEQQ, (V)PCMPGTB, (V)PCMPGTW, (V)PCMPGTD, (V)PCMPGTQ, (V)PCLMULQDQ, (V)PHADDW, (V)PHADD, (V)PHADDSW, (V)PHMINPOSUW, (V)PHSUBD, (V)PHSUBW, (V)PHSUBSW, (V)PMADDWD, (V)PMADDUBSW, (V)PMASXB, (V)PMASXW, (V)PMASXD, (V)PMASXUB, (V)PMASXUW, (V)PMASXUD, (V)PMINSB, (V)PMINSW, (V)PMINSD, (V)PMINUB, (V)PMINUW, (V)PMINUD, (V)PMULHUW, (V)PMULHRW, (V)PMULHW, (V)PMULLW, (V)PMULLD, (V)PMULUDQ, (V)PMULDQ, (V)POR, (V)PSADBW, (V)PSHUFB, (V)PSHUFD, (V)PSHUFW, (V)PSHUFLW, (V)PSIGNB, (V)PSIGNW, (V)PSIGND, (V)PSLLW, (V)PSLLD, (V)PSLLQ, (V)PSRAW, (V)PSRAD, (V)PSRLW, (V)PSRLD, (V)PSRLQ, (V)PSUBB, (V)PSUBW, (V)PSUBD, (V)PSUBQ, (V)PSUBSB, (V)PSUBSW, (V)PUNPCKHBW, (V)PUNPCKHWD, (V)PUNPCKHDQ, (V)PUNPCKHQDQ, (V)PUNPCKLBW, (V)PUNPCKLWD, (V)PUNPCKLDQ, (V)PUNPCKLQDQ, (V)PXOR, (V)RCPPS, (V)RSQRTPS, (V)SHUFPD, (V)SHUFPS, (V)UNPCKHPD, (V)UNPCKHPS, (V)UNPCKLPD, (V)UNPCKLPS, (V)XORPD, (V)XORPS, (V)VPBLEND, (V)VPERMD, (V)VPERMPS, (V)VPERMPD, (V)VPERMQ, (V)VPSLLVD, (V)VPSLLVQ, (V)VPSRAVD, (V)VPSRLVD, (V)VPSRLVQ, (V)VPERMILPD, (V)VPERMILPS, (V)VPERM2F128
Type 5	(V)CVTDQ2PD, (V)EXTRACTPS, (V)INSERTPS, (V)MOVD, (V)MOVQ, (V)MOVDDUP, (V)MOVLPD, (V)MOVLPS, (V)MOVHPD, (V)MOVHPS, (V)MOVSD, (V)MOVSS, (V)PEXTRB, (V)PEXTRD, (V)PEXTRW, (V)PEXTRQ, (V)PINSRB, (V)PINSRD, (V)PINSRW, (V)PINSRQ, (V)RCPPS, (V)RSQRTSS, (V)PMOVSX/ZX, (V)VDMXCSR*, (V)VSTMXCSR
Type 6	VEXTRACTF128, VBROADCASTSS, VBROADCASTSD, VBROADCASTF128, VINSERTF128, VMASKMOVPS**, (V)VMASKMOVDP**, (V)VMASKMOVQ, (V)VMASKMOVQ, VBROADCASTI128, VPBROADCASTB, VPBROADCASTD, VPBROADCASTW, VPBROADCASTQ, VEXTRACTI128, VINSERTI128, VPERM2I128
Type 7	(V)MOVLHPS, (V)MOVHLPs, (V)MOVMSKPD, (V)MOVMSKPS, (V)PMOVMSKB, (V)PSLLDQ, (V)PSRLDQ, (V)PSLLW, (V)PSLLD, (V)PSLLQ, (V)PSRAW, (V)PSRAD, (V)PSRLW, (V)PSRLD, (V)PSRLQ
Type 8	VZEROALL, VZERoupper
Type 11	VCVTPH2PS, VCVTPS2PH
Type 12	VGATHERDPS, VGATHERDPD, VGATHERQPS, VGATHERQPD, VPGATHERDD, VPGATHERDQ, VPGATHERQD, VPGATHERQQ

(\*) - Additional exception restrictions are present - see the Instruction description for details

(\*\*) - Instruction behavior on alignment check reporting with mask bits of less than all 1s are the same as with mask bits of all 1s, i.e. no alignment checks are performed.

## INSTRUCTION FORMAT

(\*\*\*) - PCMPSTRI, PCMPSTRM, PCMPISTRI, PCMPISTRM and LDDQU instructions do not cause #GP if the memory operand is not aligned to 16-Byte boundary.

Table 2-15 classifies exception behaviors for AVX instructions. Within each class of exception conditions that are listed in Table 2-18 through Table 2-27, certain subsets of AVX instructions may be subject to #UD exception depending on the encoded value of the VEX.L field. Table 2-17 provides supplemental information of AVX instructions that may be subject to #UD exception if encoded with incorrect values in the VEX.W or VEX.L field.

**Table 2-16. #UD Exception and VEX.W=1 Encoding**

Exception Class	#UD If VEX.W = 1 in all modes	#UD If VEX.W = 1 in non-64-bit modes
Type 1		
Type 2		
Type 3		
Type 4	VBLENDVPD, VBLENDVPS, VPBLENDVB, VTESTPD, VTESTPS, VPBLEND, VPERMD, VPERMPS, VPERM2I128, VPSRAVD, VPERMILPD, VPERMILPS, VPERM2F128	
Type 5		
Type 6	VEXTRACTF128, VBROADCASTSS, VBROADCASTSD, VBROADCASTF128, VINSERTF128, VMASKMOVPS, VMASKMOVPD, VBROADCASTI128, VPBROADCASTB/W/D, VEXTRACTI128, VINSERTI128	
Type 7		
Type 8		
Type 11	VCVTPH2PS, VCVTPS2PH	
Type 12		

Table 2-17. #UD Exception and VEX.L Field Encoding

Exception Class	#UD If VEX.L = 0	#UD If (VEX.L = 1 && AVX2 not present && AVX present)	#UD If (VEX.L = 1 && AVX2 present)
Type 1		VMOVNTDQA	
Type 2		VDPPD	VDPPD
Type 3			
Type 4		VMASKMOVDQU, VMPSADBW, VPABSB/W/D, VPACKSSWB/DW, VPACKUSWB/DW, VPADDB/W/D, VPADDQ, VPADDSB/W, VPADDUSB/W, VPALIGNR, VPAND, VPANDN, VPAVGB/W, VPBLENDVB, VPBLENDW, VPCMP(E/I)STRI/M, VPCMPEQB/W/D/Q, VPCMPGTB/W/D/Q, VPHADDW/D, VPHADDSW, VPHMINPOSUW, VPHSUBD/W, VPHSUBSW, VPMADDWD, VPMADDUBSW, VPMASB/W/D, VPMAXUB/W/D, VPMINSB/W/D, VPMINUB/W/D, VPMULHUW, VPMULHRW, VPMULHW/LW, VPMULLD, VPMULLDQ, VPMULDQ, VPOR, VPSADBW, VPSHUF/D, VPSHUFHW/LW, VPSIGNB/W/D, VPSLLW/D/Q, VPSRAW/D, VPSRLW/D/Q, VPSUBB/W/D/Q, VPSUBSB/W, VPUNPCKHBW/W/D/DQ, VPUNPCKHQDQ, VPUNPCKLBW/W/D/DQ, VPUNPCKLQDQ, VPXOR	VPCMP(E/I)STRI/M, PHMINPOSUW
Type 5		VEXTRACTPS, VINSERTPS, VMOVD, VMOVQ, VMOVLPD, VMOVLPS, VMOVHPD, VMOVHPS, VPEXTRB, VPEXTRD, VPEXTRW, VPEXTRQ, VPINSRB, VPINSRD, VPINSRW, VPINSRQ, VPMOVSX/ZX, VLDMXCSR, VSTMXCSR	Same as column 3
Type 6	VEXTRACTF128, VPERM2F128, VBROADCASTSD, VBROADCASTF128, VINSERTF128,		
Type 7		VMOVLHPS, VMOVHLPS, VPMOVMASKB, VPSLLDQ, VPSRLDQ, VPSLLW, VPSLLD, VPSLLQ, VPSRAW, VPSRAD, VPSRLW, VPSRLD, VPSRLQ	VMOVLHPS, VMOVHLPS
Type 8			
Type 11			
Type 12			

## 2.4.1 Exceptions Type 1 (Aligned memory reference)

Table 2-18. Type 1 Class Exception Conditions

Exception	Real	Virtual-8086	Protected and Compatibility	64-bit	Cause of Exception
Invalid Opcode, #UD	X	X			VEX prefix.
			X	X	VEX prefix: If XCRO[2:1] ≠ '11b'. If CR4.OSXSAVE[bit 18]=0.
	X	X	X	X	Legacy SSE instruction: If CR0.EM[bit 2] = 1. If CR4.OSFXSR[bit 9] = 0.
	X	X	X	X	If preceded by a LOCK prefix (FOH).
			X	X	If any REX, F2, F3, or 66 prefixes precede a VEX prefix.
	X	X	X	X	If any corresponding CPUID feature flag is '0'.
Device Not Available, #NM	X	X	X	X	If CR0.TS[bit 3]=1.
Stack, SS(0)			X		For an illegal address in the SS segment.
				X	If a memory address referencing the SS segment is in a non-canonical form.
General Protection, #GP(0)			X	X	VEX.256: Memory operand is not 32-byte aligned. VEX.128: Memory operand is not 16-byte aligned.
	X	X	X	X	Legacy SSE: Memory operand is not 16-byte aligned.
			X		For an illegal memory operand effective address in the CS, DS, ES, FS or GS segments.
				X	If the memory address is in a non-canonical form.
	X	X			If any part of the operand lies outside the effective address space from 0 to FFFFH.
Page Fault #PF(fault-code)		X	X	X	For a page fault.

## 2.4.2 Exceptions Type 2 (>=16 Byte Memory Reference, Unaligned)

Table 2-19. Type 2 Class Exception Conditions

Exception	Real	Virtual 8086	Protected and Compatibility	64-bit	Cause of Exception
Invalid Opcode, #UD	X	X			VEX prefix.
	X	X	X	X	If an unmasked SIMD floating-point exception and CR4.OSXMMEXCPT[bit 10] = 0.
			X	X	VEX prefix: If XCRO[2:1] ≠ '11b'. If CR4.OSXSAVE[bit 18]=0.
	X	X	X	X	Legacy SSE instruction: If CRO.EM[bit 2] = 1. If CR4.OSFXSR[bit 9] = 0.
	X	X	X	X	If preceded by a LOCK prefix (F0H).
			X	X	If any REX, F2, F3, or 66 prefixes precede a VEX prefix.
	X	X	X	X	If any corresponding CPUID feature flag is '0'.
Device Not Available, #NM	X	X	X	X	If CRO.TS[bit 3]=1.
Stack, SS(0)			X		For an illegal address in the SS segment.
				X	If a memory address referencing the SS segment is in a non-canonical form.
General Protection, #GP(0)	X	X	X	X	Legacy SSE: Memory operand is not 16-byte aligned.
			X		For an illegal memory operand effective address in the CS, DS, ES, FS or GS segments.
				X	If the memory address is in a non-canonical form.
	X	X			If any part of the operand lies outside the effective address space from 0 to FFFFH.
Page Fault #PF(fault-code)		X	X	X	For a page fault.
SIMD Floating-point Exception, #XM	X	X	X	X	If an unmasked SIMD floating-point exception and CR4.OSXMMEXCPT[bit 10] = 1.

## 2.4.3 Exceptions Type 3 (<16 Byte memory argument)

Table 2-20. Type 3 Class Exception Conditions

Exception	Real	Virtual-8086	Protected and Compatibility	64-bit	Cause of Exception
Invalid Opcode, #UD	X	X			VEX prefix.
	X	X	X	X	If an unmasked SIMD floating-point exception and CR4.OSXMMEXCPT[bit 10] = 0.
			X	X	VEX prefix: If XCRO[2:1] ≠ '11b'. If CR4.OSXSAVE[bit 18]=0.
	X	X	X	X	Legacy SSE instruction: If CR0.EM[bit 2] = 1. If CR4.OSFXSR[bit 9] = 0.
	X	X	X	X	If preceded by a LOCK prefix (FOH).
			X	X	If any REX, F2, F3, or 66 prefixes precede a VEX prefix.
	X	X	X	X	If any corresponding CPUID feature flag is '0'.
Device Not Available, #NM	X	X	X	X	If CR0.TS[bit 3]=1.
Stack, SS(0)			X		For an illegal address in the SS segment.
				X	If a memory address referencing the SS segment is in a non-canonical form.
General Protection, #GP(0)			X		For an illegal memory operand effective address in the CS, DS, ES, FS or GS segments.
				X	If the memory address is in a non-canonical form.
	X	X			If any part of the operand lies outside the effective address space from 0 to FFFFH.
Page Fault #PF(fault-code)		X	X	X	For a page fault.
Alignment Check #AC(0)		X	X	X	If alignment checking is enabled and an unaligned memory reference of 8 Bytes or less is made while the current privilege level is 3.
SIMD Floating-point Exception, #XM	X	X	X	X	If an unmasked SIMD floating-point exception and CR4.OSXMMEXCPT[bit 10] = 1.

## 2.4.4 Exceptions Type 4 (>=16 Byte mem arg no alignment, no floating-point exceptions)

Table 2-21. Type 4 Class Exception Conditions

Exception	Real	Virtual-8086	Protected and Compatibility	64-bit	Cause of Exception
Invalid Opcode, #UD	X	X			VEX prefix.
			X	X	VEX prefix: If XCRO[2:1] ≠ '11b'. If CR4.OSXSAVE[bit 18]=0.
	X	X	X	X	Legacy SSE instruction: If CRO.EM[bit 2] = 1. If CR4.OSFXSR[bit 9] = 0.
	X	X	X	X	If preceded by a LOCK prefix (FOH).
			X	X	If any REX, F2, F3, or 66 prefixes precede a VEX prefix.
	X	X	X	X	If any corresponding CPUID feature flag is '0'.
Device Not Available, #NM	X	X	X	X	If CRO.TS[bit 3]=1.
Stack, SS(0)			X		For an illegal address in the SS segment.
				X	If a memory address referencing the SS segment is in a non-canonical form.
General Protection, #GP(0)	X	X	X	X	Legacy SSE: Memory operand is not 16-byte aligned. <sup>1</sup>
			X		For an illegal memory operand effective address in the CS, DS, ES, FS or GS segments.
				X	If the memory address is in a non-canonical form.
	X	X			If any part of the operand lies outside the effective address space from 0 to FFFFH.
Page Fault #PF(fault-code)		X	X	X	For a page fault.

### NOTES:

1. PCMPSTRI, PCMPSTRM, PCMPISTRI, PCMPISTRM and LDDQU instructions do not cause #GP if the memory operand is not aligned to 16-Byte boundary.

## 2.4.5 Exceptions Type 5 (<16 Byte mem arg and no FP exceptions)

Table 2-22. Type 5 Class Exception Conditions

Exception	Real	Virtual-8086	Protected and Compatibility	64-bit	Cause of Exception
Invalid Opcode, #UD	X	X			VEX prefix.
			X	X	VEX prefix: If XCRO[2:1] ≠ '11b'. If CR4.OSXSAVE[bit 18]=0.
	X	X	X	X	Legacy SSE instruction: If CRO.EM[bit 2] = 1. If CR4.OSFXSR[bit 9] = 0.
	X	X	X	X	If preceded by a LOCK prefix (F0H).
			X	X	If any REX, F2, F3, or 66 prefixes precede a VEX prefix.
	X	X	X	X	If any corresponding CPUID feature flag is '0'.
Device Not Available, #NM	X	X	X	X	If CRO.TS[bit 3]=1.
Stack, SS(0)			X		For an illegal address in the SS segment.
				X	If a memory address referencing the SS segment is in a non-canonical form.
General Protection, #GP(0)			X		For an illegal memory operand effective address in the CS, DS, ES, FS or GS segments.
				X	If the memory address is in a non-canonical form.
	X	X			If any part of the operand lies outside the effective address space from 0 to FFFFH.
Page Fault #PF(fault-code)		X	X	X	For a page fault.
Alignment Check #AC(0)		X	X	X	If alignment checking is enabled and an unaligned memory reference is made while the current privilege level is 3.



## 2.4.6 Exceptions Type 6 (VEX-Encoded Instructions Without Legacy SSE Analogues)

Note: At present, the AVX instructions in this category do not generate floating-point exceptions.

**Table 2-23. Type 6 Class Exception Conditions**

Exception	Real	Virtual-8086	Protected and Compatibility	64-bit	Cause of Exception
Invalid Opcode, #UD	X	X			VEX prefix.
			X	X	If XCRO[2:1] ≠ '11b'. If CR4.OSXSAVE[bit 18]=0.
			X	X	If preceded by a LOCK prefix (F0H).
			X	X	If any REX, F2, F3, or 66 prefixes precede a VEX prefix.
			X	X	If any corresponding CPUID feature flag is '0'.
Device Not Available, #NM			X	X	If CR0.TS[bit 3]=1.
Stack, SS(0)			X		For an illegal address in the SS segment.
				X	If a memory address referencing the SS segment is in a non-canonical form.
General Protection, #GP(0)			X		For an illegal memory operand effective address in the CS, DS, ES, FS or GS segments.
				X	If the memory address is in a non-canonical form.
Page Fault #PF(fault-code)			X	X	For a page fault.
Alignment Check #AC(0)			X	X	For 4 or 8 byte memory references if alignment checking is enabled and an unaligned memory reference is made while the current privilege level is 3.

### 2.4.7 Exceptions Type 7 (No FP exceptions, no memory arg)

**Table 2-24. Type 7 Class Exception Conditions**

Exception	Real	Virtual-8086	Protected and Compatibility	64-bit	Cause of Exception
Invalid Opcode, #UD	X	X			VEX prefix.
			X	X	VEX prefix: If XCRO[2:1] ≠ '11b'. If CR4.OSXSAVE[bit 18]=0.
	X	X	X	X	Legacy SSE instruction: If CRO.EM[bit 2] = 1. If CR4.OSFXSR[bit 9] = 0.
	X	X	X	X	If preceded by a LOCK prefix (FOH).
			X	X	If any REX, F2, F3, or 66 prefixes precede a VEX prefix.
	X	X	X	X	If any corresponding CPUID feature flag is '0'.
Device Not Available, #NM			X	X	If CRO.TS[bit 3]=1.

### 2.4.8 Exceptions Type 8 (AVX and no memory argument)

**Table 2-25. Type 8 Class Exception Conditions**

Exception	Real	Virtual-8086	Protected and Compatibility	64-bit	Cause of Exception
Invalid Opcode, #UD	X	X			Always in Real or Virtual-8086 mode.
			X	X	If XCRO[2:1] ≠ '11b'. If CR4.OSXSAVE[bit 18]=0. If CPUID.01H.ECX.AVX[bit 28]=0. If VEX.vvvv ≠ 1111B.
	X	X	X	X	If proceeded by a LOCK prefix (FOH).
Device Not Available, #NM			X	X	If CRO.TS[bit 3]=1.

## 2.4.9 Exception Type 11 (VEX-only, mem arg no AC, floating-point exceptions)

Table 2-26. Type 11 Class Exception Conditions

Exception	Real	Virtual-8086	Protected and Compatibility	64-bit	Cause of Exception
Invalid Opcode, #UD	X	X			VEX prefix.
			X	X	VEX prefix: If XCRO[2:1] ≠ '11b'. If CR4.OSXSAVE[bit 18]=0.
	X	X	X	X	If preceded by a LOCK prefix (FOH).
			X	X	If any REX, F2, F3, or 66 prefixes precede a VEX prefix.
	X	X	X	X	If any corresponding CPUID feature flag is '0'.
Device Not Available, #NM	X	X	X	X	If CR0.TS[bit 3]=1.
Stack, SS(0)			X		For an illegal address in the SS segment.
				X	If a memory address referencing the SS segment is in a non-canonical form.
General Protection, #GP(0)			X		For an illegal memory operand effective address in the CS, DS, ES, FS or GS segments.
				X	If the memory address is in a non-canonical form.
	X	X			If any part of the operand lies outside the effective address space from 0 to FFFFH.
Page Fault #PF (fault-code)		X	X	X	For a page fault.
SIMD Floating-Point Exception, #XM	X	X	X	X	If an unmasked SIMD floating-point exception and CR4.OSXMMEXCPT[bit 10] = 1.

## 2.4.10 Exception Type 12 (VEX-only, VSIB mem arg, no AC, no floating-point exceptions)

Table 2-27. Type 12 Class Exception Conditions

Exception	Real	Virtual-8086	Protected and Compatibility	64-bit	Cause of Exception
Invalid Opcode, #UD	X	X			VEX prefix.
			X	X	VEX prefix: If XCRO[2:1] ≠ '11b'. If CR4.OSXSAVE[bit 18]=0.
	X	X	X	X	If preceded by a LOCK prefix (F0H).
			X	X	If any REX, F2, F3, or 66 prefixes precede a VEX prefix.
	X	X	X	NA	If address size attribute is 16 bit.
	X	X	X	X	If ModR/M.mod = '11b'.
	X	X	X	X	If ModR/M.rm ≠ '100b'.
	X	X	X	X	If any corresponding CPUID feature flag is '0'.
Device Not Available, #NM	X	X	X	X	If CR0.TS[bit 3]=1.
			X		For an illegal address in the SS segment.
Stack, SS(0)				X	If a memory address referencing the SS segment is in a non-canonical form.
			X		For an illegal memory operand effective address in the CS, DS, ES, FS or GS segments.
General Protection, #GP(0)				X	If the memory address is in a non-canonical form.
	X	X			If any part of the operand lies outside the effective address space from 0 to FFFFH.
Page Fault #PF (fault-code)		X	X	X	For a page fault.

## 2.5 VEX ENCODING SUPPORT FOR GPR INSTRUCTIONS

VEX prefix may be used to encode instructions that operate on neither YMM nor XMM registers. VEX-encoded general-purpose-register instructions have the following properties:

- Instruction syntax support for three encodable operands.
- Encoding support for instruction syntax of non-destructive source operand, destination operand encoded via VEX.vvvv, and destructive three-operand syntax.
- Elimination of escape opcode byte (0FH), two-byte escape via a compact bit field representation within the VEX prefix.
- Elimination of the need to use REX prefix to encode the extended half of general-purpose register sets (R8-R15) for direct register access or memory addressing.
- Flexible and more compact bit fields are provided in the VEX prefix to retain the full functionality provided by REX prefix. REX.W, REX.X, REX.B functionalities are provided in the three-byte VEX prefix only.
- VEX-encoded GPR instructions are encoded with VEX.L=0.

Any VEX-encoded GPR instruction with a 66H, F2H, or F3H prefix preceding VEX will #UD.

Any VEX-encoded GPR instruction with a REX prefix proceeding VEX will #UD.

VEX-encoded GPR instructions are not supported in real and virtual 8086 modes.

## 2.5.1 Exception Conditions for VEX-Encoded GPR Instructions

The exception conditions applicable to VEX-encoded GPR instruction differs from those of legacy GPR instructions. Table 2-28 lists VEX-encoded GPR instructions. The exception conditions for VEX-encoded GPR instructions are found in Table 2-29 for those instructions which have a default operand size of 32 bits and 16-bit operand size is not encodable.

**Table 2-28. VEX-Encoded GPR Instructions**

Exception Class	Instruction
See Table 2-29	ANDN, BLSI, BLSMSK, BLSR, BZHI, MULX, PDEP, PEXT, RORX, SARX, SHLX, SHRX

(\*) - Additional exception restrictions are present - see the Instruction description for details.

**Table 2-29. Exception Definition (VEX-Encoded GPR Instructions)**

Exception	Real	Virtual-8086	Protected and Compatibility	64-bit	Cause of Exception
Invalid Opcode, #UD	X	X	X	X	If BMI1/BMI2 CPUID feature flag is '0'.
	X	X			If a VEX prefix is present.
			X	X	If any REX, F2, F3, or 66 prefixes precede a VEX prefix.
Stack, SS(0)	X	X	X		For an illegal address in the SS segment.
				X	If a memory address referencing the SS segment is in a non-canonical form.
General Protection, #GP(0)			X		For an illegal memory operand effective address in the CS, DS, ES, FS or GS segments. If the DS, ES, FS, or GS register is used to access memory and it contains a null segment selector.
				X	If the memory address is in a non-canonical form.
	X	X			If any part of the operand lies outside the effective address space from 0 to FFFFH.
Page Fault #PF(fault-code)		X	X	X	For a page fault.
Alignment Check #AC(0)		X	X	X	If alignment checking is enabled and an unaligned memory reference is made while the current privilege level is 3.

## 2.6 INTEL® AVX-512 ENCODING

The majority of the Intel AVX-512 family of instructions (operating on 512/256/128-bit vector register operands) are encoded using a new prefix (called EVEX). Opmask instructions (operating on opmask register operands) are encoded using the VEX prefix. The EVEX prefix has some parts resembling the instruction encoding scheme using the VEX prefix, and many other capabilities not available with the VEX prefix.

The significant feature differences between EVEX and VEX are summarized below.

## INSTRUCTION FORMAT

- EVEX is a 4-Byte prefix (the first byte must be 62H); VEX is either a 2-Byte (C5H is the first byte) or 3-Byte (C4H is the first byte) prefix.
- EVEX prefix can encode 32 vector registers (XMM/YMM/ZMM) in 64-bit mode.
- EVEX prefix can encode an opmask register for conditional processing or selection control in EVEX-encoded vector instructions. Opmask instructions, whose source/destination operands are opmask registers and treat the content of an opmask register as a single value, are encoded using the VEX prefix.
- EVEX memory addressing with disp8 form uses a compressed disp8 encoding scheme to improve the encoding density of the instruction byte stream.
- EVEX prefix can encode functionality that are specific to instruction classes (e.g., packed instruction with “load+op” semantic can support embedded broadcast functionality, floating-point instruction with rounding semantic can support static rounding functionality, floating-point instruction with non-rounding arithmetic semantic can support “suppress all exceptions” functionality).

### 2.6.1 Instruction Format and EVEX

The placement of the EVEX prefix in an IA instruction is represented in Figure 2-10. Note that the values contained within brackets are optional.

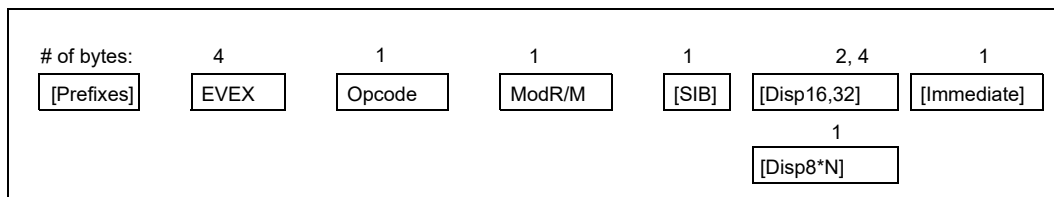

Figure 2-10. AVX-512 Instruction Format and the EVEX Prefix

The EVEX prefix is a 4-byte prefix, with the first two bytes derived from unused encoding form of the 32-bit-mode-only BOUND instruction. The layout of the EVEX prefix is shown in Figure 2-11. The first byte must be 62H, followed by three payload bytes, denoted as P0, P1, and P2 individually or collectively as P[23:0] (see Figure 2-11).

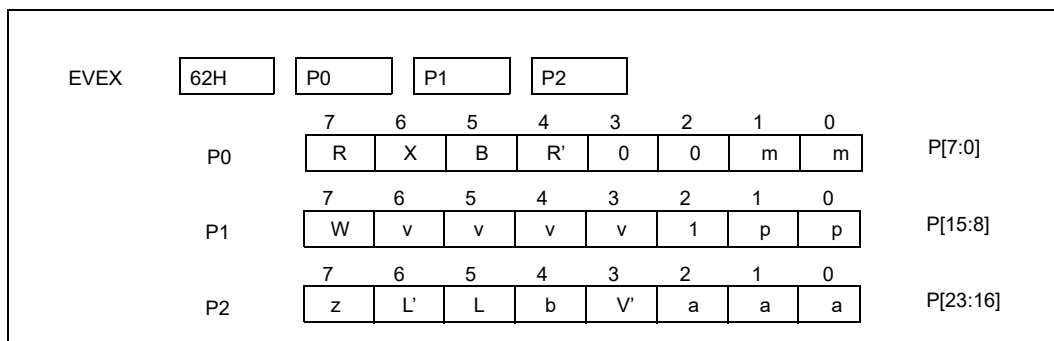

Figure 2-11. Bit Field Layout of the EVEX Prefix

Table 2-30. EVEX Prefix Bit Field Functional Grouping

Notation	Bit field Group	Position	Comment
--	Reserved	P[3 : 2]	Must be 0.
--	Fixed Value	P[10]	Must be 1.
EVEX.mm	Compressed legacy escape	P[1: 0]	Identical to low two bits of VEX.mmmmm.
EVEX.pp	Compressed legacy prefix	P[9 : 8]	Identical to VEX.pp.
EVEX.RXB	Next-8 register specifier modifier	P[7 : 5]	Combine with ModR/M.reg, ModR/M.rm (base, index/vidx).
EVEX.R'	High-16 register specifier modifier	P[4]	Combine with EVEX.R and ModR/M.reg.
EVEX.X	High-16 register specifier modifier	P[6]	Combine with EVEX.B and ModR/M.rm, when SIB/VSIB absent.
EVEX.vvvv	NDS register specifier	P[14 : 11]	Same as VEX.vvvv.
EVEX.V'	High-16 NDS/VIDX register specifier	P[19]	Combine with EVEX.vvvv or when VSIB present.
EVEX.aaa	Embedded opmask register specifier	P[18 : 16]	
EVEX.W	Osize promotion/Opcode extension	P[15]	
EVEX.z	Zeroing/Merging	P[23]	
EVEX.b	Broadcast/RC/SAE Context	P[20]	
EVEX.L'L	Vector length/RC	P[22 : 21]	

The bit fields in P[23:0] are divided into the following functional groups (Table 2-30 provides a tabular summary):

- Reserved bits: P[3:2] must be 0, otherwise #UD.
- Fixed-value bit: P[10] must be 1, otherwise #UD.
- Compressed legacy prefix/escape bytes: P[1:0] is identical to the lowest 2 bits of VEX.mmmmm; P[9:8] is identical to VEX.pp.
- Operand specifier modifier bits for vector register, general purpose register, memory addressing: P[7:5] allows access to the next set of 8 registers beyond the low 8 registers when combined with ModR/M register specifiers.
- Operand specifier modifier bit for vector register: P[4] (or EVEX.R') allows access to the high 16 vector register set when combined with P[7] and ModR/M.reg specifier; P[6] can also provide access to a high 16 vector register when SIB or VSIB addressing are not needed.
- Non-destructive source /vector index operand specifier: P[19] and P[14:11] encode the second source vector register operand in a non-destructive source syntax, vector index register operand can access an upper 16 vector register using P[19].
- Op-mask register specifiers: P[18:16] encodes op-mask register set k0-k7 in instructions operating on vector registers.
- EVEX.W: P[15] is similar to VEX.W which serves either as opcode extension bit or operand size promotion to 64-bit in 64-bit mode.
- Vector destination merging/zeroing: P[23] encodes the destination result behavior which either zeroes the masked elements or leave masked element unchanged.
- Broadcast/Static-rounding/SAE context bit: P[20] encodes multiple functionality, which differs across different classes of instructions and can affect the meaning of the remaining field (EVEX.L'L). The functionality for the following instruction classes are:
  - Broadcasting a single element across the destination vector register: this applies to the instruction class with Load+Op semantic where one of the source operand is from memory.
  - Redirect L'L field (P[22:21]) as static rounding control for floating-point instructions with rounding semantic. Static rounding control overrides MXCSR.RC field and implies "Suppress all exceptions" (SAE).
  - Enable SAE for floating -point instructions with arithmetic semantic that is not rounding.
  - For instruction classes outside of the afore-mentioned three classes, setting EVEX.b will cause #UD.

- Vector length/rounding control specifier: P[22:21] can serve one of three options.
  - Vector length information for packed vector instructions.
  - Ignored for instructions operating on vector register content as a single data element.
  - Rounding control for floating-point instructions that have a rounding semantic and whose source and destination operands are all vector registers.

## 2.6.2 Register Specifier Encoding and EVEX

EVEX-encoded instruction can access 8 opmask registers, 16 general-purpose registers and 32 vector registers in 64-bit mode (8 general-purpose registers and 8 vector registers in non-64-bit modes). EVEX-encoding can support instruction syntax that access up to 4 instruction operands. Normal memory addressing modes and VSIB memory addressing are supported with EVEX prefix encoding. The mapping of register operands used by various instruction syntax and memory addressing in 64-bit mode are shown in Table 2-31. Opmask register encoding is described in Section 2.6.3.

**Table 2-31. 32-Register Support in 64-bit Mode Using EVEX with Embedded REX Bits**

	4 <sup>1</sup>	3	[2:0]	Reg. Type	Common Usages
<b>REG</b>	EVEX.R'	REX.R	modrm.reg	GPR, Vector	Destination or Source
<b>NDS/NDD</b>	EVEX.V'	EVEX.vvvv		GPR, Vector	2ndSource or Destination
<b>RM</b>	EVEX.X	EVEX.B	modrm.r/m	GPR, Vector	1st Source or Destination
<b>BASE</b>	0	EVEX.B	modrm.r/m	GPR	memory addressing
<b>INDEX</b>	0	EVEX.X	sib.index	GPR	memory addressing
<b>VIDX</b>	EVEX.V'	EVEX.X	sib.index	Vector	VSIB memory addressing

### NOTES:

1. Not applicable for accessing general purpose registers.

The mapping of register operands used by various instruction syntax and memory addressing in 32-bit modes are shown in Table 2-32.

**Table 2-32. EVEX Encoding Register Specifiers in 32-bit Mode**

	[2:0]	Reg. Type	Common Usages
<b>REG</b>	modrm.reg	GPR, Vector	Destination or Source
<b>NDS/NDD</b>	EVEX.vvv	GPR, Vector	2nd Source or Destination
<b>RM</b>	modrm.r/m	GPR, Vector	1st Source or Destination
<b>BASE</b>	modrm.r/m	GPR	Memory Addressing
<b>INDEX</b>	sib.index	GPR	Memory Addressing
<b>VIDX</b>	sib.index	Vector	VSIB Memory Addressing

## 2.6.3 Opmask Register Encoding

There are eight opmask registers, k0-k7. Opmask register encoding falls into two categories:

- Opmask registers that are the source or destination operands of an instruction treating the content of opmask register as a scalar value, are encoded using the VEX prefix scheme. It can support up to three operands using standard modR/M byte's reg field and rm field and VEX.vvvv. Such a scalar opmask instruction does not support conditional update of the destination operand.
- An opmask register providing conditional processing and/or conditional update of the destination register of a vector instruction is encoded using EVEX.aaa field (see Section 2.6.4).



- An opmask register serving as the destination or source operand of a vector instruction is encoded using standard modR/M byte's reg field and rm fields.

Table 2-33. Opmask Register Specifier Encoding

	[2:0]	Register Access	Common Usages
REG	modrm.reg	k0-k7	Source
NDS	VEX.vvvv	k0-k7	2nd Source
RM	modrm.r/m	k0-7	1st Source
{k1}	EVEX.aaa	k0 <sup>1</sup> -k7	Opmask

**NOTES:**

- Instructions that overwrite the conditional mask in opmask do not permit using k0 as the embedded mask.

## 2.6.4 Masking Support in EVEX

EVEX can encode an opmask register to conditionally control per-element computational operation and updating of result of an instruction to the destination operand. The predicate operand is known as the opmask register. The EVEX.aaa field, P[18:16] of the EVEX prefix, is used to encode one out of a set of eight 64-bit architectural registers. Note that from this set of 8 architectural registers, only k1 through k7 can be addressed as predicate operands. k0 can be used as a regular source or destination but cannot be encoded as a predicate operand.

AVX-512 instructions support two types of masking with EVEX.z bit (P[23]) controlling the type of masking:

- Merging-masking, which is the default type of masking for EVEX-encoded vector instructions, preserves the old value of each element of the destination where the corresponding mask bit has a 0. It corresponds to the case of EVEX.z = 0.
- Zeroing-masking, is enabled by having the EVEX.z bit set to 1. In this case, an element of the destination is set to 0 when the corresponding mask bit has a 0 value.

AVX-512 Foundation instructions can be divided into the following groups:

- Instructions which support “zeroing-masking”.
  - Also allow merging-masking.
- Instructions which require aaa = 000.
  - Do not allow any form of masking.
- Instructions which allow merging-masking but do not allow zeroing-masking.
  - Require EVEX.z to be set to 0.
  - This group is mostly composed of instructions that write to memory.
- Instructions which require aaa <> 000 do not allow EVEX.z to be set to 1.
  - Allow merging-masking and do not allow zeroing-masking, e.g., gather instructions.

## 2.6.5 Compressed Displacement (disp8\*N) Support in EVEX

For memory addressing using disp8 form, EVEX-encoded instructions always use a compressed displacement scheme by multiplying disp8 in conjunction with a scaling factor N that is determined based on the vector length, the value of EVEX.b bit (embedded broadcast) and the input element size of the instruction. In general, the factor N corresponds to the number of bytes characterizing the internal memory operation of the input operand (e.g., 64 when the accessing a full 512-bit memory vector). The scale factor N is listed in Table 2-34 and Table 2-35 below, where EVEX encoded instructions are classified using the **tupletype** attribute. The scale factor N of each tupletype is listed based on the vector length (VL) and other factors affecting it.

Table 2-34 covers EVEX-encoded instructions which has a load semantic in conjunction with additional computational or data element movement operation, operating either on the full vector or half vector (due to conversion of

numerical precision from a wider format to narrower format). EVEX.b is supported for such instructions for data element sizes which are either dword or qword (see Section 2.6.11).

EVEX-encoded instruction that are pure load/store, and “Load+op” instruction semantic that operate on data element size less than dword do not support broadcasting using EVEX.b. These are listed in Table 2-35. Table 2-35 also includes many broadcast instructions which perform broadcast using a subset of data elements without using EVEX.b. These instructions and a few data element size conversion instructions are covered in Table 2-35. Instruction classified in Table 2-35 do not use EVEX.b and EVEX.b must be 0, otherwise #UD will occur.

The tuple type will be referenced in the instruction operand encoding table in the reference page of each instruction, providing the cross reference for the scaling factor N to encoding memory addressing operand.

Note that the disp8\*N rules still apply when using 16b addressing.

**Table 2-34. Compressed Displacement (DISP8\*N) Affected by Embedded Broadcast**

TupleType	EVEX.b	InputSize	EVEX.W	Broadcast	N (VL=128)	N (VL=256)	N (VL= 512)	Comment
Full	0	32bit	0	none	16	32	64	Load+Op (Full Vector Dword/Qword)
	1	32bit	0	{1tox}	4	4	4	
	0	64bit	1	none	16	32	64	
	1	64bit	1	{1tox}	8	8	8	
Half	0	32bit	0	none	8	16	32	Load+Op (Half Vector)
	1	32bit	0	{1tox}	4	4	4	

**Table 2-35. EVEX DISP8\*N for Instructions Not Affected by Embedded Broadcast**

TupleType	InputSize	EVEX.W	N (VL= 128)	N (VL= 256)	N (VL= 512)	Comment
Full Mem	N/A	N/A	16	32	64	Load/store or subDword full vector
Tuple1 Scalar	8bit	N/A	1	1	1	1 Tuple
	16bit	N/A	2	2	2	
	32bit	0	4	4	4	
	64bit	1	8	8	8	
Tuple1 Fixed	32bit	N/A	4	4	4	1 Tuple, memsize not affected by EVEX.W
	64bit	N/A	8	8	8	
Tuple2	32bit	0	8	8	8	Broadcast (2 elements)
	64bit	1	NA	16	16	
Tuple4	32bit	0	NA	16	16	Broadcast (4 elements)
	64bit	1	NA	NA	32	
Tuple8	32bit	0	NA	NA	32	Broadcast (8 elements)
Half Mem	N/A	N/A	8	16	32	SubQword Conversion
Quarter Mem	N/A	N/A	4	8	16	SubDword Conversion
Eighth Mem	N/A	N/A	2	4	8	SubWord Conversion
Mem128	N/A	N/A	16	16	16	Shift count from memory
MOVDDUP	N/A	N/A	8	32	64	VMOVDDUP

## 2.6.6 EVEX Encoding of Broadcast/Rounding/SAE Support

EVEX.b can provide three types of encoding context, depending on the instruction classes:

- Embedded broadcasting of one data element from a source memory operand to the destination for vector instructions with “load+op” semantic.
- Static rounding control overriding MXCSR.RC for floating-point instructions with rounding semantic.
- “Suppress All exceptions” (SAE) overriding MXCSR mask control for floating-point arithmetic instructions that do not have rounding semantic.

## 2.6.7 Embedded Broadcast Support in EVEX

EVEX encodes an embedded broadcast functionality that is supported on many vector instructions with 32-bit (double word or single-precision floating-point) and 64-bit data elements, and when the source operand is from memory. EVEX.b (P[20]) bit is used to enable broadcast on load-op instructions. When enabled, only one element is loaded from memory and broadcasted to all other elements instead of loading the full memory size.

The following instruction classes do not support embedded broadcasting:

- Instructions with only one scalar result is written to the vector destination.
- Instructions with explicit broadcast functionality provided by its opcode.
- Instruction semantic is a pure load or a pure store operation.

## 2.6.8 Static Rounding Support in EVEX

Static rounding control embedded in the EVEX encoding system applies only to register-to-register flavor of floating-point instructions with rounding semantic at two distinct vector lengths: (i) scalar, (ii) 512-bit. In both cases, the field EVEX.L'L expresses rounding mode control overriding MXCSR.RC if EVEX.b is set. When EVEX.b is set, “suppress all exceptions” is implied. The processor behaves as if all MXCSR masking controls are set.

## 2.6.9 SAE Support in EVEX

The EVEX encoding system allows arithmetic floating-point instructions without rounding semantic to be encoded with the SAE attribute. This capability applies to scalar and 512-bit vector lengths, register-to-register only, by setting EVEX.b. When EVEX.b is set, “suppress all exceptions” is implied. The processor behaves as if all MXCSR masking controls are set.

## 2.6.10 Vector Length Orthogonality

The architecture of EVEX encoding scheme can support SIMD instructions operating at multiple vector lengths. Many AVX-512 Foundation instructions operate at 512-bit vector length. The vector length of EVEX encoded vector instructions are generally determined using the L'L field in EVEX prefix, except for 512-bit floating-point, reg-reg instructions with rounding semantic. The table below shows the vector length corresponding to various values of the L'L bits. When EVEX is used to encode scalar instructions, L'L is generally ignored.

When EVEX.b bit is set for a register-register instructions with floating-point rounding semantic, the same two bits P2[6:5] specifies rounding mode for the instruction, with implied SAE behavior. The mapping of different instruction classes relative to the embedded broadcast/rounding/SAE control and the EVEX.L'L fields are summarized in Table 2-36.

**Table 2-36. EVEX Embedded Broadcast/Rounding/SAE and Vector Length on Vector Instructions**

Position	P2[4]	P2[6:5]	P2[6:5]
Broadcast/Rounding/SAE Context	EVEX.b	EVEX.L'L	EVEX.RC
Reg-reg, FP Instructions w/ rounding semantic	Enable static rounding control (SAE implied)	Vector length Implied (512 bit or scalar)	00b: SAE + RNE 01b: SAE + RD 10b: SAE + RU 11b: SAE + RZ
FP Instructions w/o rounding semantic, can cause #XF	SAE control	00b: 128-bit 01b: 256-bit 10b: 512-bit 11b: Reserved (#UD)	NA
Load+op Instructions w/ memory source	Broadcast Control		NA
Other Instructions ( Explicit Load/Store/Broadcast/Gather/Scatter)	Must be 0 (otherwise #UD)		NA

## 2.6.11 #UD Equations for EVEX

Instructions encoded using EVEX can face three types of UD conditions: state dependent, opcode independent and opcode dependent.

### 2.6.11.1 State Dependent #UD

In general, attempts to execute an instruction, which required OS support for incremental extended state component, will #UD if required state components were not enabled by OS. Table 2-37 lists instruction categories with respect to required processor state components. Attempts to execute a given category of instructions while enabled states were less than the required bit vector in XCR0 shown in Table 2-37 will cause #UD.

**Table 2-37. OS XSAVE Enabling Requirements of Instruction Categories**

Instruction Categories	Vector Register State Access	Required XCR0 Bit Vector [7:0]
Legacy SIMD prefix encoded Instructions (e.g SSE)	XMM	xxxxxx11b
VEX-encoded instructions operating on YMM	YMM	xxxxx111b
EVEX-encoded 128-bit instructions	ZMM	111xx111b
EVEX-encoded 256-bit instructions	ZMM	111xx111b
EVEX-encoded 512-bit instructions	ZMM	111xx111b
VEX-encoded instructions operating on opmask	k-reg	xx1xxx11b

### 2.6.11.2 Opcode Independent #UD

A number of bit fields in EVEX encoded instruction must obey mode-specific but opcode-independent patterns listed in Table 2-38.

**Table 2-38. Opcode Independent, State Dependent EVEX Bit Fields**

Position	Notation	64-bit #UD	Non-64-bit #UD
P[3 : 2]	--	if > 0	if > 0
P[10]	--	if 0	if 0
P[1 : 0]	EVEX.mm	if 00b	if 00b
P[7 : 6]	EVEX.RX	None (valid)	None (BOUND if EVEX.RX != 11b)

### 2.6.11.3 Opcode Dependent #UD

This section describes legal values for the rest of the EVEX bit fields. Table 2-39 lists the #UD conditions of EVEX prefix bit fields which encodes or modifies register operands.

**Table 2-39. #UD Conditions of Operand-Encoding EVEX Prefix Bit Fields**

Notation	Position	Operand Encoding	64-bit #UD	Non-64-bit #UD
EVEX.R	P[7]	ModRM.reg encodes k-reg	if EVEX.R = 0	None (BOUND if EVEX.RX != 11b)
		ModRM.reg is opcode extension	None (ignored)	
		ModRM.reg encodes all other registers	None (valid)	
EVEX.X	P[6]	ModRM.r/m encodes ZMM/YMM/XMM	None (valid)	
		ModRM.r/m encodes k-reg or GPR	None (ignored)	
		ModRM.r/m without SIB/VSIB	None (ignored)	
		ModRM.r/m with SIB/VSIB	None (valid)	
EVEX.B	P[5]	ModRM.r/m encodes k-reg	None (ignored)	None (ignored)
		ModRM.r/m encodes other registers	None (valid)	
		ModRM.r/m base present	None (valid)	
		ModRM.r/m base not present	None (ignored)	
EVEXR'	P[4]	ModRM.reg encodes k-reg or GPR	if 0	None (ignored)
		ModRM.reg is opcode extension	None (ignored)	
		ModRM.reg encodes ZMM/YMM/XMM	None (valid)	
EVEX.vvvv	P[14 : 11]	vvvv encodes ZMM/YMM/XMM	None (valid)	None (valid) P[14] ignored
		Otherwise	if != 1111b	if != 1111b
EVEXV'	P[19]	Encodes ZMM/YMM/XMM	None (valid)	None (ignored)
		Otherwise	if 0	None (ignored)

Table 2-40 lists the #UD conditions of instruction encoding of opmask register using EVEX.aaa and EVEX.z

**Table 2-40. #UD Conditions of Opmask Related Encoding Field**

Notation	Position	Operand Encoding	64-bit #UD	Non-64-bit #UD
EVEX.aaa	P[18 : 16]	Instructions do not use opmask for conditional processing <sup>1</sup> .	if aaa != 000b	if aaa != 000b
		Opmask used as conditional processing mask and updated at completion <sup>2</sup> .	if aaa = 000b	if aaa = 000b;
		Opmask used as conditional processing.	None (valid <sup>3</sup> )	None (valid <sup>1</sup> )
EVEX.z	P[23]	Vector instruction using opmask as source or destination <sup>4</sup> .	if EVEX.z != 0	if EVEX.z != 0
		Store instructions or gather/scatter instructions.	if EVEX.z != 0	if EVEX.z != 0
		Instruction supporting conditional processing mask with EVEX.aaa = 000b.	if EVEX.z != 0	if EVEX.z != 0
VEX.vvvv	Varies	K-regs are instruction operands not mask control.	if vvvv = 0xxx	None

#### NOTES:

1. E.g., VBROADCASTMxxx, VPMOVM2x, VPMOVx2M.

2. E.g., Gather/Scatter family.

3. aaa can take any value. A value of 000 indicates that there is no masking on the instruction; in this case, all elements will be processed as if there was a mask of 'all ones' regardless of the actual value in KO.

4. E.g., VFPClassPD/PS, VCMPB/D/Q/W family, VPMOVM2x, VPMOVx2M.

Table 2-41 lists the #UD conditions of EVEX bit fields that depends on the context of EVEX.b.

**Table 2-41. #UD Conditions Dependent on EVEX.b Context**

Notation	Position	Operand Encoding	64-bit #UD	Non-64-bit #UD
EVEX.L'Lb	P[22 : 20]	Reg-reg, FP instructions with rounding semantic.	None (valid <sup>1</sup> )	None (valid <sup>1</sup> )
		Other reg-reg, FP instructions that can cause #XF.	None (valid <sup>2</sup> )	None (valid <sup>2</sup> )
		Other reg-mem instructions in Table 2-34.	None (valid <sup>3</sup> )	None (valid <sup>3</sup> )
		Other instruction classes <sup>4</sup> in Table 2-35.	If EVEX.b > 0	If EVEX.b > 0

**NOTES:**

1. L'L specifies rounding control, see Table 2-36, supports {er} syntax.
2. L'L specifies vector length, see Table 2-36, supports {sae} syntax.
3. L'L specifies vector length, see Table 2-36, supports embedded broadcast syntax
4. L'L specifies either vector length or ignored.

### 2.6.12 Device Not Available

EVEX-encoded instructions follow the same rules when it comes to generating #NM (Device Not Available) exception. In particular, it is generated when CR0.TS[bit 3]= 1.

### 2.6.13 Scalar Instructions

EVEX-encoded scalar SIMD instructions can access up to 32 registers in 64-bit mode. Scalar instructions support masking (using the least significant bit of the opmask register), but broadcasting is not supported.

## 2.7 EXCEPTION CLASSIFICATIONS OF EVEX-ENCODED INSTRUCTIONS

The exception behavior of EVEX-encoded instructions can be classified into the classes shown in the rest of this section. The classification of EVEX-encoded instructions follow a similar framework as those of AVX and AVX2 instructions using the VEX prefix. Exception types for EVEX-encoded instructions are named in the style of "E##" or with a suffix "E##XX". The "##" designation generally follows that of AVX/AVX2 instructions. The majority of EVEX encoded instruction with "Load+op" semantic supports memory fault suppression, which is represented by E##. The instructions with "Load+op" semantic but do not support fault suppression are named "E##NF". A summary table of exception classes by class names are shown below.

**Table 2-42. EVEX-Encoded Instruction Exception Class Summary**

Exception Class	Instruction set	Mem arg	(#XM)
Type E1	Vector Moves/Load/Stores	Explicitly aligned, w/ fault suppression	None
Type E1NF	Vector Non-temporal Stores	Explicitly aligned, no fault suppression	None
Type E2	FP Vector Load+op	Support fault suppression	Yes
Type E2NF	FP Vector Load+op	No fault suppression	Yes
Type E3	FP Scalar/Partial Vector, Load+Op	Support fault suppression	Yes
Type E3NF	FP Scalar/Partial Vector, Load+Op	No fault suppression	Yes
Type E4	Integer Vector Load+op	Support fault suppression	No
Type E4NF	Integer Vector Load+op	No fault suppression	No
Type E5	Legacy-like Promotion	Varies, Support fault suppression	No

**Table 2-42. EVEX-Encoded Instruction Exception Class Summary**

Exception Class	Instruction set	Mem arg	(#XM)
Type E5NF	Legacy-like Promotion	Varies, No fault suppression	No
Type E6	Post AVX Promotion	Varies, w/ fault suppression	No
Type E6NF	Post AVX Promotion	Varies, no fault suppression	No
Type E7NM	Register-to-register op	None	None
Type E9NF	Miscellaneous 128-bit	Vector-length Specific, no fault suppression	None
Type E10	Non-XF Scalar	Vector Length ignored, w/ fault suppression	None
Type E10NF	Non-XF Scalar	Vector Length ignored, no fault suppression	None
Type E11	VCVTPH2PS	Half Vector Length, w/ fault suppression	Yes
Type E11NF	VCVTPS2PH	Half Vector Length, no fault suppression	Yes
Type E12	Gather and Scatter Family	VSIB addressing, w/ fault suppression	None
Type E12NP	Gather and Scatter Prefetch Family	VSIB addressing, w/o page fault	None

Table 2-43 lists EVEX-encoded instruction mnemonic by exception classes.

**Table 2-43. EVEX Instructions in each Exception Class**

Exception Class	Instruction
Type E1	VMOVAPD, VMOVAPS, VMOVDQA32, VMOVDQA64
Type E1NF	VMOVNTDQ, VMOVNTDQA, VMOVNTPD, VMOVNTPS
Type E2	VADDPD, VADDPs, VCMPPD, VCMPPS, VCVTDQ2PS, VCVTPD2DQ, VCVTPD2PS, VCVTPS2DQ, VCVTTPD2DQ, VCVTTPS2DQ, VDIVPD, VDIVPS, VFMADDxxxPD, VFMADDxxxPS, VFMSUBADDxxxPD, VFMSUBADDxxxPS, VFMSUBxxxPD, VFMSUBxxxPS, VFNMADDxxxPD, VFNMADDxxxPS, VFNMSUBxxxPD, VFNMSUBxxxPS, VMAXPD, VMAXPS, VMINPD, VMINPS, VMULPD, VMULPS, VSQRTPD, VSQRTPS, VSUBPD, VSUBPS VCVTPD2QQ, VCVTPD2UQQ, VCVTPD2UDQ, VCVTPS2UDQS, VCVTQQ2PD, VCVTQQ2PS, VCVTTPD2DQ, VCVTTPD2QQ, VCVTTPD2UDQ, VCVTTPD2UQQ, VCVTTPS2DQ, VCVTTPS2UDQ, VCVTUDQ2PS, VCVTUQQ2PD, VCVTUQQ2PS, VFIXUPIMMPD, VFIXUPIMMPS, VGETEXPPD, VGETEXPPS, VGETMANTPD, VGETMANTPS, VRANGEPD, VRANGEPS, VREDUCEPD, VREDUCEPS, VRNDSCALEPD, VRNDSCALEPS, VSCALEFPD, VSCALEFPS, VRCP28PD, VRCP28PS, VRSQRT28PD, VRSQRT28PS
Type E3	VADDSD, VADDSS, VCMPSD, VCMPSs, VCVTPS2PD, VCVTSD2SS, VCVTSS2SD, VDIVSD, VDIVSS, VMAXSD, VMAXSS, VMINSD, VMINSS, VMULSD, VMULSS, VSQRTSD, VSQRTSS, VSUBSD, VSUBSS VCVTPS2QQ, VCVTPS2UQQ, VCVTTPS2QQ, VCVTTPS2UQQ, VFMADDxxxSD, VFMADDxxxSS, VFMSUBxxxSD, VFMSUBxxxSS, VFNMADDxxxSD, VFNMADDxxxSS, VFNMSUBxxxSD, VFNMSUBxxxSS, VFIXUPIMMSD, VFIXUPIMMSS, VGETEXPSD, VGETEXPSS, VGETMANTSD, VGETMANTSS, VRANGESD, VRANGESS, VREDUCESD, VREDUCESS, VRNDSCALESD, VRNDSCALESS, VSCALEFSD, VSCALEFSS, VRCP28SD, VRCP28SS, VRSQRT28SD, VRSQRT28SS
Type E3NF	VCOMISD, VCOMISS, VCVTSD2SI, VCVTSI2SD, VCVTSI2SS, VCVTSS2SI, VCVTSS2SD, VCVTSS2SI, VUCOMISD, VUCOMISS VCVTSD2USI, VCVTSS2USI, VCVTSS2USI, VCVTSS2USI, VCVTUSI2SD, VCVTUSI2SS

Table 2-43. EVEX Instructions in each Exception Class (Contd.)

Exception Class	Instruction
Type E4	VANDPD, VANDPS, VANDNPD, VANDNPS, VORPD, VORPS, VPABSD, VPABSQ, VPADDD, VPADDQ, VPANDD, VPANDQ, VPANDND, VPANDNQ, VPCMPEQD, VPCMPEQQ, VPCMPGTD, VPCMPGTQ, VPMAXSD, VPMAXSQ, VPMAXUD, VPMAXUQ, VPMINSQ, VPMINSQ, VPMINUD, VPMINUQ, VPMULLD, VPMULLQ, VPMULUDQ, VPMULDQ, VPORD, VPORQ, VPSUBD, VPSUBQ, VPXORD, VPXORQ, VXORPD, VXORPS, VPSLLVD, VPSLLVQ, VBLENDMPD, VBLENDMPS, VPBLENDMD, VPBLENDMQ, VFPCLASSPD, VFPCLASSPS, VPCMPD, VPCMPQ, VPCMPUD, VPCMPUQ, VPLZCNTD, VPLZCNTQ, VPROLD, VPROLQ, (VPSLLD, VPSLLQ, VPSRAD, VPSRAQ, VPSRLD, VPSRLQ) <sup>1</sup> , VPTERNLOGD, VPTERNLOGQ, VPTESTMD, VPTESTMQ, VPTESTNMD, VPTESTNMQ, VRCP14PD, VRCP14PS, VRSQRT14PD, VRSQRT14PS, VPSRAVW, VPSRAVD, VPSRAVW, VPSRAVQ, VPMADD52LUQ, VPMADD52HUQ
E4.nb <sup>2</sup>	VMOVUPD, VMOVUPS, VMOVDQU8, VMOVDQU16, VMOVDQU32, VMOVDQU64, VPCMPB, VPCMPW, VPCMPUB, VPCMPUW, VEXPANDPD, VEXPANDPS, VPCOMPRESSD, VPCOMPRESSQ, VEXPANDD, VEXPANDQ, VCOMPRESSPD, VCOMPRESSPS, VPABSB, VPABSW, VPADDB, VPADDW, VPADDSB, VPADDSW, VPADDUSB, VPADDUSW, VPAVGB, VPAVGW, VPCMPEQB, VPCMPEQW, VPCMPGTB, VPCMPGTW, VPMAXSB, VPMAXSW, VPMAXUB, VPMAXUW, VPMINSB, VPMINSW, VPMINUB, VPMINUW, VPMULHRW, VPMULHUW, VPMULHW, VPMULLW, VPSUBB, VPSUBW, VPSUBSB, VPSUBSW, VPTESTMB, VPTESTMW, VPTESTNMB, VPTESTNMW, VPSLLW, VPSRAW, VPSRLW, VPSLLVW, VPSRLVW
Type E4NF	VPACKSSDW, VPACKUSDW, VPSHUFD, VPUNPCKHDQ, VPUNPCKHQDQ, VPUNPCKLDQ, VPUNPCKLQDQ, VSHUFPD, VSHUFPS, VUNPCKHPD, VUNPCKHPS, VUNPCKLPD, VUNPCKLPS, VPERMD, VPERMPS, VPERMPD, VPERMQ, VALIGND, VALIGNQ, VPCONFLICTD, VPCONFLICTQ, VPERMI2D, VPERMI2PS, VPERMI2PD, VPERMI2Q, VPERMT2D, VPERMT2PS, VPERMT2Q, VPERMT2PD, VPERMILPD, VPERMILPS, VSHUFI32X4, VSHUFI64X2, VSHUFF32X4, VSHUFF64X2, VPMULTISHIFTQB
E4NF.nb <sup>2</sup>	VDBPSADBW, VPACKSSWB, VPACKUSWB, VPALIGNR, VPMADDWD, VPMADDUBSW, VMOVSHDUP, VMOVSLDUP, VPSADBW, VPSHUFB, VPSHUFBW, VPSHUFLW, VPSLLDQ, VPSRLDQ, VPSLLW, VPSRAW, VPSRLW, (VPSLLD, VPSLLQ, VPSRAD, VPSRAQ, VPSRLD, VPSRLQ) <sup>3</sup> , VPUNPCKHBW, VPUNPCKHWD, VPUNPCKLBW, VPUNPCKLWD, VPERMW, VPERMI2W, VPERMT2W
Type E5	VCVTDQ2PD, PMOVSWB, PMOVXWB, PMOVXBD, PMOVXQB, PMOVXWD, PMOVXWQ, PMOVXQD, PMOVZXBW, PMOVZXBQ, PMOVZXBQ, PMOVZXWD, PMOVZXWQ, PMOVZXDQ, VCVTUDQ2PD
Type E5NF	VMOVDDUP
Type E6	VBROADCASTSS, VBROADCASTSD, VBROADCASTF32X4, VBROADCASTI32X4, VPBROADCASTB, VPBROADCASTD, VPBROADCASTW, VPBROADCASTQ, VBROADCASTF32X2, VBROADCASTF32X4, VBROADCASTF64X2, VBROADCASTF32X8, VBROADCASTF64X4, VBROADCASTI32X2, VBROADCASTI32X4, VBROADCASTI64X2, VBROADCASTI32X8, VBROADCASTI64X4, VFPCLASSSD, VFPCLASSSS, VPMOVQB, VPMOVQB, VPMOVUSQB, VPMOVQW, VPMOVSQW, VPMOVUSQW, VPMOVQD, VPMOVSD, VPMOVUSQD, VPMOVDB, VPMOVSD, VPMOVUSDB, VPMOVDW, VPMOVSDW, VPMOVUSDW, VPMOVWB, VPMOVSWB, VPMOVUSWB
Type E6NF	VEXTRACTF32X4, VEXTRACTF64X2, VEXTRACTF32X8, VINSERTF32X4, VINSERTF64X2, VINSERTF64X4, VINSERTF32X8, VINSERTI32X4, VINSERTI64X2, VINSERTI64X4, VINSERTI32X8, VEXTRACTI32X4, VEXTRACTI64X2, VEXTRACTI32X8, VEXTRACTI64X4, VPBROADCASTMB2Q, VPBROADCASTMW2D
Type E7NM.128 <sup>4</sup>	VMOVLHPS, VMOVHLPS
Type E7NM.	(VPBROADCASTD, VPBROADCASTQ, VPBROADCASTB, VPBROADCASTW) <sup>5</sup> , VPMOVM2B, VPMOVM2D, VPMOVM2Q, VPMOVM2W, VPMOV2M, VPMOVB2M, VPMOVD2M, VPMOVQ2M, VPMOVW2M



Table 2-43. EVEX Instructions in each Exception Class (Contd.)

Exception Class	Instruction
Type E9NF	VEXTRACTPS, VINSERTPS, VMOVHPD, VMOVHPS, VMOVLPD, VMOVLPS, VMOVD, VMOVQ, VPEXTRB, VPEXTRD, VPEXTRW, VPEXTRQ, VPINSRB, VPINSRD, VPINSRW, VPINSRQ
Type E10	VMOVSD, VMOVSS, VRCP14SD, VRCP14SS, VRSQRT14SD, VRSQRT14SS,
Type E10NF	(VCVTSI2SD, VCVTUSI2SD) <sup>6</sup>
Type E11	VCVTPH2PS, VCVTPS2PH
Type E12	VGATHERDPS, VGATHERDPD, VGATHERQPS, VGATHERQPD, VPGATHERDD, VPGATHERDQ, VPGATHERQD, VPGATHERQQ, VPSCATTERDD, VPSCATTERDQ, VPSCATTERQD, VPSCATTERQQ, VSCATTERDPD, VSCATTERDPS, VSCATTERQPD, VSCATTERQPS
Type E12NP	VGATHERPFODPD, VGATHERPFODPS, VGATHERPFOQPD, VGATHERPFOQPS, VGATHERPF1DPD, VGATHERPF1DPS, VGATHERPF1QPD, VGATHERPF1QPS, VSCATTERPFODPD, VSCATTERPFODPS, VSCATTERPFOQPD, VSCATTERPFOQPS, VSCATTERPF1DPD, VSCATTERPF1DPS, VSCATTERPF1QPD, VSCATTERPF1QPS

**NOTES:**

1. Operand encoding Full tupletype with immediate.
2. Embedded broadcast is not supported with the “.nb” suffix.
3. Operand encoding Mem128 tupletype.
4. #UD raised if EVEX.L'L !=00b (VL=128).
5. The source operand is a general purpose register.
6. W0 encoding only.

## 2.7.1 Exceptions Type E1 and E1NF of EVEX-Encoded Instructions

EVEX-encoded instructions with memory alignment restrictions, and supporting memory fault suppression follow exception class E1.

**Table 2-44. Type E1 Class Exception Conditions**

Exception	Real	Virtual 80x86	Protected and Compatibility	64-bit	Cause of Exception
Invalid Opcode, #UD	X	X			If EVEX prefix present.
			X	X	If CR4.OSXSAVE[bit 18]=0. If any one of following conditions applies: <ul style="list-style-type: none"> <li>State requirement, Table 2-37 not met.</li> <li>Opcode independent #UD condition in Table 2-38.</li> <li>Operand encoding #UD conditions in Table 2-39.</li> <li>Opmask encoding #UD condition of Table 2-40.</li> <li>If EVEX.b != 0.</li> <li>If EVEX.L'L != 10b (VL=512).</li> </ul>
	X	X	X	X	If preceded by a LOCK prefix (FOH).
			X	X	If any REX, F2, F3, or 66 prefixes precede a EVEX prefix.
	X	X	X	X	If any corresponding CPUID feature flag is '0'.
Device Not Available, #NM	X	X	X	X	If CR0.TS[bit 3]=1.
Stack, SS(0)			X		If fault suppression not set, and an illegal address in the SS segment.
				X	If fault suppression not set, and a memory address referencing the SS segment is in a non-canonical form.
General Protection, #GP(0)			X	X	EVEX.512: Memory operand is not 64-byte aligned. EVEX.256: Memory operand is not 32-byte aligned. EVEX.128: Memory operand is not 16-byte aligned.
			X		If fault suppression not set, and an illegal memory operand effective address in the CS, DS, ES, FS or GS segments.
				X	If fault suppression not set, and the memory address is in a non-canonical form.
	X	X			If fault suppression not set, and any part of the operand lies outside the effective address space from 0 to FFFFH.
Page Fault #PF(fault-code)		X	X	X	If fault suppression not set, and a page fault.

EVEX-encoded instructions with memory alignment restrictions, but do not support memory fault suppression follow exception class E1NF.

**Table 2-45. Type E1NF Class Exception Conditions**

Exception	Real	Virtual 80x86	Protected and Compatibility	64-bit	Cause of Exception
Invalid Opcode, #UD	X	X			If EVEX prefix present.
			X	X	If CR4.OSXSAVE[bit 18]=0. If any one of following conditions applies: <ul style="list-style-type: none"> <li>▪ State requirement, Table 2-37 not met.</li> <li>▪ Opcode independent #UD condition in Table 2-38.</li> <li>▪ Operand encoding #UD conditions in Table 2-39.</li> <li>▪ Opmask encoding #UD condition of Table 2-40.</li> <li>▪ If EVEX.b != 0.</li> <li>▪ If EVEX.L'L != 10b (VL=512).</li> </ul>
	X	X	X	X	If preceded by a LOCK prefix (F0H).
			X	X	If any REX, F2, F3, or 66 prefixes precede a EVEX prefix.
	X	X	X	X	If any corresponding CPUID feature flag is '0'.
Device Not Available, #NM	X	X	X	X	If CR0.TS[bit 3]=1.
Stack, SS(0)			X		For an illegal address in the SS segment.
				X	If a memory address referencing the SS segment is in a non-canonical form.
General Protection, #GP(0)			X	X	EVEX.512: Memory operand is not 64-byte aligned. EVEX.256: Memory operand is not 32-byte aligned. EVEX.128: Memory operand is not 16-byte aligned.
			X		For an illegal memory operand effective address in the CS, DS, ES, FS or GS segments.
				X	If the memory address is in a non-canonical form.
	X	X			If any part of the operand lies outside the effective address space from 0 to FFFFH.
Page Fault #PF(fault-code)		X	X	X	For a page fault.

## 2.7.2 Exceptions Type E2 of EVEX-Encoded Instructions

EVEX-encoded vector instructions with arithmetic semantic follow exception class E2.

**Table 2-46. Type E2 Class Exception Conditions**

Exception	Real	Virtual 8086	Protected and Compatibility	64-bit	Cause of Exception
Invalid Opcode, #UD	X	X			If EVEX prefix present.
	X	X	X	X	If an unmasked SIMD floating-point exception and CR4.OSXMMEXCPT[bit 10] = 0.
			X	X	If CR4.OSXSAVE[bit 18]=0. If any one of following conditions applies: <ul style="list-style-type: none"> <li>▪ State requirement, Table 2-37 not met.</li> <li>▪ Opcode independent #UD condition in Table 2-38.</li> <li>▪ Operand encoding #UD conditions in Table 2-39.</li> <li>▪ Opmask encoding #UD condition of Table 2-40.</li> <li>▪ If EVEX.L'L != 10b (VL=512).</li> </ul>
	X	X	X	X	If preceded by a LOCK prefix (F0H).
			X	X	If any REX, F2, F3, or 66 prefixes precede a EVEX prefix.
	X	X	X	X	If any corresponding CPUID feature flag is '0'.
Device Not Available, #NM	X	X	X	X	If CR0.TS[bit 3]=1.
Stack, SS(0)			X		If fault suppression not set, and an illegal address in the SS segment.
				X	If fault suppression not set, and a memory address referencing the SS segment is in a non-canonical form.
General Protection, #GP(0)			X		If fault suppression not set, and an illegal memory operand effective address in the CS, DS, ES, FS or GS segments.
				X	If fault suppression not set, and the memory address is in a non-canonical form.
	X	X			If fault suppression not set, and any part of the operand lies outside the effective address space from 0 to FFFFH.
Page Fault #PF(fault-code)		X	X	X	If fault suppression not set, and a page fault.
Alignment Check #AC(0)		X	X	X	If EVEX.B=1, alignment checking is enabled, and an unaligned memory reference of 8 bytes or less is made while the current privilege level is 3.
SIMD Floating-point Exception, #XM	X	X	X	X	If an unmasked SIMD floating-point exception, {sae} or {er} not set, and CR4.OSXMMEXCPT[bit 10] = 1.

## 2.7.3 Exceptions Type E3 and E3NF of EVEX-Encoded Instructions

EVEX-encoded scalar instructions with arithmetic semantic that support memory fault suppression follow exception class E3.

**Table 2-47. Type E3 Class Exception Conditions**

Exception	Real	Virtual 80x86	Protected and Compatibility	64-bit	Cause of Exception
Invalid Opcode, #UD	X	X			If EVEX prefix present.
	X	X	X	X	If an unmasked SIMD floating-point exception and CR4.OSXMMEXCPT[bit 10] = 0.
			X	X	If CR4.OSXSAVE[bit 18]=0. If any one of following conditions applies: <ul style="list-style-type: none"> <li>▪ State requirement, Table 2-37 not met.</li> <li>▪ Opcode independent #UD condition in Table 2-38.</li> <li>▪ Operand encoding #UD conditions in Table 2-39.</li> <li>▪ Opmask encoding #UD condition of Table 2-40.</li> <li>▪ If EVEX.b != 0.</li> </ul>
	X	X	X	X	If preceded by a LOCK prefix (F0H).
			X	X	If any REX, F2, F3, or 66 prefixes precede a EVEX prefix.
	X	X	X	X	If any corresponding CPUID feature flag is '0'.
Device Not Available, #NM	X	X	X	X	If CR0.TS[bit 3]=1.
Stack, SS(0)			X		If fault suppression not set, and an illegal address in the SS segment.
				X	If fault suppression not set, and a memory address referencing the SS segment is in a non-canonical form.
General Protection, #GP(0)			X		If fault suppression not set, and an illegal memory operand effective address in the CS, DS, ES, FS or GS segments.
				X	If fault suppression not set, and the memory address is in a non-canonical form.
	X	X			If fault suppression not set, and any part of the operand lies outside the effective address space from 0 to FFFFH.
Page Fault #PF(fault-code)		X	X	X	If fault suppression not set, and a page fault.
Alignment Check #AC(0)		X	X	X	If alignment checking is enabled and an unaligned memory reference of 8 bytes or less is made while the current privilege level is 3.
SIMD Floating-point Exception, #XM	X	X	X	X	If an unmasked SIMD floating-point exception, {sae} or {er} not set, and CR4.OSXMMEXCPT[bit 10] = 1.

EVEX-encoded scalar instructions with arithmetic semantic that do not support memory fault suppression follow exception class E3NF.

**Table 2-48. Type E3NF Class Exception Conditions**

Exception	Real	Virtual 80x86	Protected and Compatibility	64-bit	Cause of Exception
Invalid Opcode, #UD	X	X			EVEX prefix.
	X	X	X	X	If an unmasked SIMD floating-point exception and CR4.OSXMMEXCPT[bit 10] = 0.
			X	X	If CR4.OSXSAVE[bit 18]=0. If any one of following conditions applies: <ul style="list-style-type: none"> <li>▪ State requirement, Table 2-37 not met.</li> <li>▪ Opcode independent #UD condition in Table 2-38.</li> <li>▪ Operand encoding #UD conditions in Table 2-39.</li> <li>▪ Opmask encoding #UD condition of Table 2-40.</li> <li>▪ If EVEX.b != 0.</li> </ul>
	X	X	X	X	If preceded by a LOCK prefix (F0H).
			X	X	If any REX, F2, F3, or 66 prefixes precede a EVEX prefix.
	X	X	X	X	If any corresponding CPUID feature flag is '0'.
Device Not Available, #NM	X	X	X	X	If CR0.TS[bit 3]=1.
Stack, SS(0)			X		For an illegal address in the SS segment.
				X	If a memory address referencing the SS segment is in a non-canonical form.
General Protection, #GP(0)			X		For an illegal memory operand effective address in the CS, DS, ES, FS or GS segments.
				X	If the memory address is in a non-canonical form.
	X	X			If any part of the operand lies outside the effective address space from 0 to FFFFH.
Page Fault #PF(fault-code)		X	X	X	For a page fault.
Alignment Check #AC(0)		X	X	X	If alignment checking is enabled and an unaligned memory reference of 8 bytes or less is made while the current privilege level is 3.
SIMD Floating-point Exception, #XM	X	X	X	X	If an unmasked SIMD floating-point exception, {sae} or {er} not set, and CR4.OSXMMEXCPT[bit 10] = 1.

## 2.7.4 Exceptions Type E4 and E4NF of EVEX-Encoded Instructions

EVEX-encoded vector instructions that cause no SIMD FP exception and support memory fault suppression follow exception class E4.

**Table 2-49. Type E4 Class Exception Conditions**

Exception	Real	Virtual 80x86	Protected and Compatibility	64-bit	Cause of Exception
Invalid Opcode, #UD	X	X			If EVEX prefix present.
			X	X	If CR4.OSXSAVE[bit 18]=0. If any one of following conditions applies: <ul style="list-style-type: none"> <li>▪ State requirement, Table 2-37 not met.</li> <li>▪ Opcode independent #UD condition in Table 2-38.</li> <li>▪ Operand encoding #UD conditions in Table 2-39.</li> <li>▪ Opmask encoding #UD condition of Table 2-40.</li> <li>▪ If EVEX.b != 0 and in E4.nb subclass (see E4.nb entries in Table 2-43).</li> <li>▪ If EVEX.L'L != 10b (VL=512).</li> </ul>
	X	X	X	X	If preceded by a LOCK prefix (F0H).
			X	X	If any REX, F2, F3, or 66 prefixes precede a EVEX prefix.
	X	X	X	X	If any corresponding CPUID feature flag is '0'.
Device Not Available, #NM	X	X	X	X	If CR0.TS[bit 3]=1.
Stack, SS(0)			X		If fault suppression not set, and an illegal address in the SS segment.
				X	If fault suppression not set, and a memory address referencing the SS segment is in a non-canonical form.
General Protection, #GP(0)			X		If fault suppression not set, and an illegal memory operand effective address in the CS, DS, ES, FS or GS segments.
				X	If fault suppression not set, and the memory address is in a non-canonical form.
	X	X			If fault suppression not set, and any part of the operand lies outside the effective address space from 0 to FFFFH.
Page Fault #PF(fault-code)		X	X	X	If fault suppression not set, and a page fault.
Alignment Check #AC(0)		X	X	X	If EVEX.B=1, alignment checking is enabled, and an unaligned memory reference of 8 bytes or less is made while the current privilege level is 3.

EVEX-encoded vector instructions that do not cause SIMD FP exception nor support memory fault suppression follow exception class E4NF.

**Table 2-50. Type E4NF Class Exception Conditions**

Exception	Real	Virtual 180x86	Protected and Compatibility	64-bit	Cause of Exception
Invalid Opcode, #UD	X	X			If EVEX prefix present.
			X	X	If CR4.OSXSAVE[bit 18]=0. If any one of following conditions applies: <ul style="list-style-type: none"> <li>▪ State requirement, Table 2-37 not met.</li> <li>▪ Opcode independent #UD condition in Table 2-38.</li> <li>▪ Operand encoding #UD conditions in Table 2-39.</li> <li>▪ Opmask encoding #UD condition of Table 2-40.</li> <li>▪ If EVEX.b != 0 and in E4NF.nb subclass (see E4NF.nb entries in Table 2-43).</li> <li>▪ If EVEX.L'L != 10b (VL=512).</li> </ul>
	X	X	X	X	If preceded by a LOCK prefix (F0H).
			X	X	If any REX, F2, F3, or 66 prefixes precede a EVEX prefix.
	X	X	X	X	If any corresponding CPUID feature flag is '0'.
Device Not Available, #NM	X	X	X	X	If CR0.TS[bit 3]=1.
Stack, SS(0)			X		For an illegal address in the SS segment.
				X	If a memory address referencing the SS segment is in a non-canonical form.
General Protection, #GP(0)			X		For an illegal memory operand effective address in the CS, DS, ES, FS or GS segments.
				X	If the memory address is in a non-canonical form.
	X	X			If any part of the operand lies outside the effective address space from 0 to FFFFH.
Page Fault #PF(fault-code)		X	X	X	For a page fault.



## 2.7.5 Exceptions Type E5 and E5NF

EVEX-encoded scalar/partial-vector instructions that cause no SIMD FP exception and support memory fault suppression follow exception class E5.

**Table 2-51. Type E5 Class Exception Conditions**

Exception	Real	Virtual 80x86	Protected and Compatibility	64-bit	Cause of Exception
Invalid Opcode, #UD	X	X			If EVEX prefix present.
			X	X	If CR4.OSXSAVE[bit 18]=0. If any one of following conditions applies: <ul style="list-style-type: none"> <li>State requirement, Table 2-37 not met.</li> <li>Opcode independent #UD condition in Table 2-38.</li> <li>Operand encoding #UD conditions in Table 2-39.</li> <li>Opmask encoding #UD condition of Table 2-40.</li> <li>If EVEX.b != 0.</li> <li>If EVEX.L'L != 10b (VL=512).</li> </ul>
	X	X	X	X	If preceded by a LOCK prefix (FOH).
			X	X	If any REX, F2, F3, or 66 prefixes precede a EVEX prefix.
	X	X	X	X	If any corresponding CPUID feature flag is '0'.
Device Not Available, #NM	X	X	X	X	If CR0.TS[bit 3]=1.
Stack, SS(0)			X		If fault suppression not set, and an illegal address in the SS segment.
				X	If fault suppression not set, and a memory address referencing the SS segment is in a non-canonical form.
General Protection, #GP(0)			X		If fault suppression not set, and an illegal memory operand effective address in the CS, DS, ES, FS or GS segments.
				X	If fault suppression not set, and the memory address is in a non-canonical form.
	X	X			If fault suppression not set, and any part of the operand lies outside the effective address space from 0 to FFFFH.
Page Fault #PF(fault-code)		X	X	X	If fault suppression not set, and a page fault.
Alignment Check #AC(0)		X	X	X	If alignment checking is enabled and an unaligned memory reference of 8 bytes or less is made while the current privilege level is 3.

EVEX-encoded scalar/partial vector instructions that do not cause SIMD FP exception nor support memory fault suppression follow exception class E5NF.

Table 2-52. Type E5NF Class Exception Conditions

Exception	Real	Virtual 80x86	Protected and Compatibility	64-bit	Cause of Exception
Invalid Opcode, #UD	X	X			If EVEX prefix present.
			X	X	If CR4.OSXSAVE[bit 18]=0. If any one of following conditions applies: <ul style="list-style-type: none"> <li>▪ State requirement, Table 2-37 not met.</li> <li>▪ Opcode independent #UD condition in Table 2-38.</li> <li>▪ Operand encoding #UD conditions in Table 2-39.</li> <li>▪ Opmask encoding #UD condition of Table 2-40.</li> <li>▪ If EVEX.b != 0.</li> <li>▪ If EVEX.L'L != 10b (VL=512).</li> </ul>
	X	X	X	X	If preceded by a LOCK prefix (FOH).
			X	X	If any REX, F2, F3, or 66 prefixes precede a EVEX prefix.
	X	X	X	X	If any corresponding CPUID feature flag is '0'.
Device Not Available, #NM	X	X	X	X	If CR0.TS[bit 3]=1.
Stack, SS(0)			X		If an illegal address in the SS segment.
				X	If a memory address referencing the SS segment is in a non-canonical form.
General Protection, #GP(0)			X		If an illegal memory operand effective address in the CS, DS, ES, FS or GS segments.
				X	If the memory address is in a non-canonical form.
	X	X			If any part of the operand lies outside the effective address space from 0 to FFFFH.
Page Fault #PF(fault-code)		X	X	X	For a page fault.
Alignment Check #AC(0)		X	X	X	If alignment checking is enabled and an unaligned memory reference of 8 bytes or less is made while the current privilege level is 3.

## 2.7.6 Exceptions Type E6 and E6NF

Table 2-53. Type E6 Class Exception Conditions

Exception	Real	Virtual 80x86	Protected and Compatibility	64-bit	Cause of Exception
Invalid Opcode, #UD	X	X			If EVEX prefix present.
			X	X	If CR4.OSXSAVE[bit 18]=0. If any one of following conditions applies: <ul style="list-style-type: none"> <li>▪ State requirement, Table 2-37 not met.</li> <li>▪ Opcode independent #UD condition in Table 2-38.</li> <li>▪ Operand encoding #UD conditions in Table 2-39.</li> <li>▪ Opmask encoding #UD condition of Table 2-40.</li> <li>▪ If EVEX.b != 0.</li> <li>▪ If EVEX.L'L != 10b (VL=512).</li> </ul>
			X	X	If preceded by a LOCK prefix (FOH).
			X	X	If any REX, F2, F3, or 66 prefixes precede a EVEX prefix.
			X	X	If any corresponding CPUID feature flag is '0'.
Device Not Available, #NM			X	X	If CR0.TS[bit 3]=1.
Stack, SS(0)			X		If fault suppression not set, and an illegal address in the SS segment.
				X	If fault suppression not set, and a memory address referencing the SS segment is in a non-canonical form.
General Protection, #GP(0)			X		If fault suppression not set, and an illegal memory operand effective address in the CS, DS, ES, FS or GS segments.
				X	If fault suppression not set, and the memory address is in a non-canonical form.
Page Fault #PF(fault-code)			X	X	If fault suppression not set, and a page fault.
Alignment Check #AC(0)			X	X	For 4 or 8 byte memory references if alignment checking is enabled and an unaligned memory reference of 8 bytes or less is made while the current privilege level is 3.

EVEX-encoded instructions that do not cause SIMD FP exception nor support memory fault suppression follow exception class E6NF.

**Table 2-54. Type E6NF Class Exception Conditions**

Exception	Real	Virtual 80x86	Protected and Compatibility	64-bit	Cause of Exception
Invalid Opcode, #UD	X	X			If EVEX prefix present.
			X	X	If CR4.OSXSAVE[bit 18]=0. If any one of following conditions applies: <ul style="list-style-type: none"> <li>▪ State requirement, Table 2-37 not met.</li> <li>▪ Opcode independent #UD condition in Table 2-38.</li> <li>▪ Operand encoding #UD conditions in Table 2-39.</li> <li>▪ Opmask encoding #UD condition of Table 2-40.</li> <li>▪ If EVEX.b != 0.</li> <li>▪ If EVEX.L'L != 10b (VL=512).</li> </ul>
			X	X	If preceded by a LOCK prefix (FOH).
			X	X	If any REX, F2, F3, or 66 prefixes precede a EVEX prefix.
			X	X	If any corresponding CPUID feature flag is '0'.
Device Not Available, #NM			X	X	If CR0.TS[bit 3]=1.
Stack, SS(0)			X		For an illegal address in the SS segment.
				X	If a memory address referencing the SS segment is in a non-canonical form.
General Protection, #GP(0)			X		For an illegal memory operand effective address in the CS, DS, ES, FS or GS segments.
				X	If the memory address is in a non-canonical form.
Page Fault #PF(fault-code)			X	X	For a page fault.
Alignment Check #AC(0)			X	X	For 4 or 8 byte memory references if alignment checking is enabled and an unaligned memory reference of 8 bytes or less is made while the current privilege level is 3.

## 2.7.7 Exceptions Type E7NM

EVEX-encoded instructions that cause no SIMD FP exception and do not reference memory follow exception class E7NM.

**Table 2-55. Type E7NM Class Exception Conditions**

Exception	Real	Virtual 80x86	Protected and Compatibility	64-bit	Cause of Exception
Invalid Opcode, #UD	X	X			If EVEX prefix present.
			X	X	If CR4.OSXSAVE[bit 18]=0. If any one of following conditions applies: <ul style="list-style-type: none"> <li>▪ State requirement, Table 2-37 not met.</li> <li>▪ Opcode independent #UD condition in Table 2-38.</li> <li>▪ Operand encoding #UD conditions in Table 2-39.</li> <li>▪ Opmask encoding #UD condition of Table 2-40.</li> <li>▪ If EVEX.b != 0.</li> <li>▪ Instruction specific EVEX.L'L restriction not met.</li> </ul>
	X	X	X	X	If preceded by a LOCK prefix (FOH).
			X	X	If any REX, F2, F3, or 66 prefixes precede a EVEX prefix.
	X	X	X	X	If any corresponding CPUID feature flag is '0'.
Device Not Available, #NM			X	X	If CR0.TS[bit 3]=1.

## 2.7.8 Exceptions Type E9 and E9NF

EVEX-encoded vector or partial-vector instructions that do not cause no SIMD FP exception and support memory fault suppression follow exception class E9.

**Table 2-56. Type E9 Class Exception Conditions**

Exception	Real	Virtual 80x86	Protected and Compatibility	64-bit	Cause of Exception
Invalid Opcode, #UD	X	X			If EVEX prefix present.
			X	X	If CR4.OSXSAVE[bit 18]=0. If any one of following conditions applies: <ul style="list-style-type: none"> <li>State requirement, Table 2-37 not met.</li> <li>Opcode independent #UD condition in Table 2-38.</li> <li>Operand encoding #UD conditions in Table 2-39.</li> <li>Opmask encoding #UD condition of Table 2-40.</li> <li>If EVEX.b != 0.</li> <li>If EVEX.L'L != 00b (VL=128).</li> </ul>
	X	X	X	X	If preceded by a LOCK prefix (FOH).
			X	X	If any REX, F2, F3, or 66 prefixes precede a EVEX prefix.
	X	X	X	X	If any corresponding CPUID feature flag is '0'.
Device Not Available, #NM	X	X	X	X	If CR0.TS[bit 3]=1.
Stack, SS(0)			X		If fault suppression not set, and an illegal address in the SS segment.
				X	If fault suppression not set, and a memory address referencing the SS segment is in a non-canonical form.
General Protection, #GP(0)			X		If fault suppression not set, and an illegal memory operand effective address in the CS, DS, ES, FS or GS segments.
				X	If fault suppression not set, and the memory address is in a non-canonical form.
	X	X			If fault suppression not set, and any part of the operand lies outside the effective address space from 0 to FFFFH.
Page Fault #PF(fault-code)		X	X	X	If fault suppression not set, and a page fault.
Alignment Check #AC(0)		X	X	X	If alignment checking is enabled and an unaligned memory reference of 8 bytes or less is made while the current privilege level is 3.

EVEX-encoded vector or partial-vector instructions that must be encoded with VEX.L'L = 0, do not cause SIMD FP exception nor support memory fault suppression follow exception class E9NF.

**Table 2-57. Type E9NF Class Exception Conditions**

Exception	Real	Virtual 80x86	Protected and Compatibility	64-bit	Cause of Exception
Invalid Opcode, #UD	X	X			If EVEX prefix present.
			X	X	If CR4.OSXSAVE[bit 18]=0. If any one of following conditions applies: <ul style="list-style-type: none"> <li>▪ State requirement, Table 2-37 not met.</li> <li>▪ Opcode independent #UD condition in Table 2-38.</li> <li>▪ Operand encoding #UD conditions in Table 2-39.</li> <li>▪ Opmask encoding #UD condition of Table 2-40.</li> <li>▪ If EVEX.b != 0.</li> <li>▪ If EVEX.L'L != 00b (VL=128).</li> </ul>
	X	X	X	X	If preceded by a LOCK prefix (FOH).
			X	X	If any REX, F2, F3, or 66 prefixes precede a EVEX prefix.
	X	X	X	X	If any corresponding CPUID feature flag is '0'.
Device Not Available, #NM	X	X	X	X	If CR0.TS[bit 3]=1.
Stack, SS(0)			X		If an illegal address in the SS segment.
				X	If a memory address referencing the SS segment is in a non-canonical form.
General Protection, #GP(0)			X		If an illegal memory operand effective address in the CS, DS, ES, FS or GS segments.
				X	If the memory address is in a non-canonical form.
	X	X			If any part of the operand lies outside the effective address space from 0 to FFFFH.
Page Fault #PF(fault-code)		X	X	X	For a page fault.
Alignment Check #AC(0)		X	X	X	If alignment checking is enabled and an unaligned memory reference is made while the current privilege level is 3.

## 2.7.9 Exceptions Type E10

EVEX-encoded scalar instructions that ignore EVEX.L'L vector length encoding and do not cause no SIMD FP exception, support memory fault suppression follow exception class E10.

**Table 2-58. Type E10 Class Exception Conditions**

Exception	Real	Virtual 80x86	Protected and Compatibility	64-bit	Cause of Exception
Invalid Opcode, #UD	X	X			If EVEX prefix present.
			X	X	If CR4.OSXSAVE[bit 18]=0. If any one of following conditions applies: <ul style="list-style-type: none"> <li>State requirement, Table 2-37 not met.</li> <li>Opcode independent #UD condition in Table 2-38.</li> <li>Operand encoding #UD conditions in Table 2-39.</li> <li>Opmask encoding #UD condition of Table 2-40.</li> <li>If EVEX.b != 0.</li> </ul>
	X	X	X	X	If preceded by a LOCK prefix (FOH).
			X	X	If any REX, F2, F3, or 66 prefixes precede a EVEX prefix.
	X	X	X	X	If any corresponding CPUID feature flag is '0'.
Device Not Available, #NM	X	X	X	X	If CR0.TS[bit 3]=1.
Stack, SS(0)			X		If fault suppression not set, and an illegal address in the SS segment.
				X	If fault suppression not set, and a memory address referencing the SS segment is in a non-canonical form.
General Protection, #GP(0)			X		If fault suppression not set, and an illegal memory operand effective address in the CS, DS, ES, FS or GS segments.
				X	If fault suppression not set, and the memory address is in a non-canonical form.
	X	X			If fault suppression not set, and any part of the operand lies outside the effective address space from 0 to FFFFH.
Page Fault #PF(fault-code)		X	X	X	If fault suppression not set, and a page fault.
Alignment Check #AC(0)		X	X	X	If alignment checking is enabled and an unaligned memory reference of 8 bytes or less is made while the current privilege level is 3.



EVEX-encoded scalar instructions that must be encoded with VEX.L'L = 0, do not cause SIMD FP exception nor support memory fault suppression follow exception class E10NF.

**Table 2-59. Type E10NF Class Exception Conditions**

Exception	Real	Virtual 80x86	Protected and Compatibility	64-bit	Cause of Exception
Invalid Opcode, #UD	X	X			If EVEX prefix present.
			X	X	If CR4.OSXSAVE[bit 18]=0. If any one of following conditions applies: <ul style="list-style-type: none"> <li>State requirement, Table 2-37 not met.</li> <li>Opcode independent #UD condition in Table 2-38.</li> <li>Operand encoding #UD conditions in Table 2-39.</li> <li>Opmask encoding #UD condition of Table 2-40.</li> <li>If EVEX.b != 0.</li> </ul>
	X	X	X	X	If preceded by a LOCK prefix (F0H).
			X	X	If any REX, F2, F3, or 66 prefixes precede a EVEX prefix.
	X	X	X	X	If any corresponding CPUID feature flag is '0'.
Device Not Available, #NM	X	X	X	X	If CR0.TS[bit 3]=1.
Stack, SS(0)			X		If fault suppression not set, and an illegal address in the SS segment.
				X	If fault suppression not set, and a memory address referencing the SS segment is in a non-canonical form.
General Protection, #GP(0)			X		If fault suppression not set, and an illegal memory operand effective address in the CS, DS, ES, FS or GS segments.
				X	If fault suppression not set, and the memory address is in a non-canonical form.
	X	X			If fault suppression not set, and any part of the operand lies outside the effective address space from 0 to FFFFH.
Page Fault #PF(fault-code)		X	X	X	If fault suppression not set, and a page fault.
Alignment Check #AC(0)		X	X	X	If alignment checking is enabled and an unaligned memory reference of 8 bytes or less is made while the current privilege level is 3.

## 2.7.10 Exception Type E11 (EVEX-only, mem arg no AC, floating-point exceptions)

EVEX-encoded instructions that can cause SIMD FP exception, memory operand support fault suppression but do not cause #AC follow exception class E11.

**Table 2-60. Type E11 Class Exception Conditions**

Exception	Real	Virtual 80x86	Protected and Compatibility	64-bit	Cause of Exception
Invalid Opcode, #UD	X	X			If EVEX prefix present.
			X	X	If CR4.OSXSAVE[bit 18]=0. If any one of following conditions applies: <ul style="list-style-type: none"> <li>State requirement, Table 2-37 not met.</li> <li>Opcode independent #UD condition in Table 2-38.</li> <li>Operand encoding #UD conditions in Table 2-39.</li> <li>Opmask encoding #UD condition of Table 2-40.</li> <li>If EVEX.b != 0.</li> <li>If EVEX.L'L != 10b (VL=512).</li> </ul>
	X	X	X	X	If preceded by a LOCK prefix (FOH).
			X	X	If any REX, F2, F3, or 66 prefixes precede a EVEX prefix.
	X	X	X	X	If any corresponding CPUID feature flag is '0'.
Device Not Available, #NM	X	X	X	X	If CR0.TS[bit 3]=1.
Stack, SS(0)			X		If fault suppression not set, and an illegal address in the SS segment.
				X	If fault suppression not set, and a memory address referencing the SS segment is in a non-canonical form.
General Protection, #GP(0)			X		If fault suppression not set, and an illegal memory operand effective address in the CS, DS, ES, FS or GS segments.
				X	If fault suppression not set, and the memory address is in a non-canonical form.
	X	X			If fault suppression not set, and any part of the operand lies outside the effective address space from 0 to FFFFH.
Page Fault #PF (fault-code)		X	X	X	If fault suppression not set, and a page fault.
SIMD Floating-Point Exception, #XM	X	X	X	X	If an unmasked SIMD floating-point exception, {sae} not set, and CR4.OSXMMEX-CPT[bit 10] = 1.

## 2.7.11 Exception Type E12 and E12NP (VSIB mem arg, no AC, no floating-point exceptions)

Table 2-61. Type E12 Class Exception Conditions

Exception	Real	Virtual 80x86	Protected and Compatibility	64-bit	Cause of Exception
Invalid Opcode, #UD	X	X			If EVEX prefix present.
			X	X	If CR4.OSXSAVE[bit 18]=0. If any one of following conditions applies: <ul style="list-style-type: none"> <li>State requirement, Table 2-37 not met.</li> <li>Opcode independent #UD condition in Table 2-38.</li> <li>Operand encoding #UD conditions in Table 2-39.</li> <li>Opmask encoding #UD condition of Table 2-40.</li> <li>If EVEX.b != 0.</li> <li>If EVEX.L'L != 10b (VL=512).</li> <li>If vvvv != 1111b.</li> </ul>
	X	X	X	X	If preceded by a LOCK prefix (F0H).
			X	X	If any REX, F2, F3, or 66 prefixes precede a VEX prefix.
	X	X	X	NA	If address size attribute is 16 bit.
	X	X	X	X	If ModR/M.mod = '11b'.
	X	X	X	X	If ModR/M.rm != '100b'.
	X	X	X	X	If any corresponding CPUID feature flag is '0'.
	X	X	X	X	If k0 is used (gather or scatter operation).
X	X	X	X	If index = destination register (gather operation).	
Device Not Available, #NM	X	X	X	X	If CR0.TS[bit 3]=1.
Stack, SS(0)			X		For an illegal address in the SS segment.
				X	If a memory address referencing the SS segment is in a non-canonical form.
General Protection, #GP(0)			X		For an illegal memory operand effective address in the CS, DS, ES, FS or GS segments.
				X	If the memory address is in a non-canonical form.
	X	X			If any part of the operand lies outside the effective address space from 0 to FFFFH.
Page Fault #PF (fault-code)		X	X	X	For a page fault.

EVEX-encoded prefetch instructions that do not cause #PF follow exception class E12NP.

**Table 2-62. Type E12NP Class Exception Conditions**

Exception	Real	Virtual 80x86	Protected and Compatibility	64-bit	Cause of Exception
Invalid Opcode, #UD	X	X			If EVEX prefix present.
			X	X	If CR4.OSXSAVE[bit 18]=0. If any one of following conditions applies: <ul style="list-style-type: none"> <li>▪ State requirement, Table 2-37 not met.</li> <li>▪ Opcode independent #UD condition in Table 2-38.</li> <li>▪ Operand encoding #UD conditions in Table 2-39.</li> <li>▪ Opmask encoding #UD condition of Table 2-40.</li> <li>▪ If EVEX.b != 0.</li> <li>▪ If EVEX.L'L != 10b (VL=512).</li> </ul>
	X	X	X	X	If preceded by a LOCK prefix (F0H).
			X	X	If any REX, F2, F3, or 66 prefixes precede a VEX prefix.
	X	X	X	NA	If address size attribute is 16 bit.
	X	X	X	X	If ModR/M.mod = '11b'.
	X	X	X	X	If ModR/M.rm != '100b'.
	X	X	X	X	If any corresponding CPUID feature flag is '0'.
X	X	X	X	If k0 is used (gather or scatter operation).	
Device Not Available, #NM	X	X	X	X	If CR0.TS[bit 3]=1.
Stack, SS(0)			X		For an illegal address in the SS segment.
				X	If a memory address referencing the SS segment is in a non-canonical form.
General Protection, #GP(0)			X		For an illegal memory operand effective address in the CS, DS, ES, FS or GS segments.
				X	If the memory address is in a non-canonical form.
	X	X			If any part of the operand lies outside the effective address space from 0 to FFFFH.

## 2.8 EXCEPTION CLASSIFICATIONS OF OPMASK INSTRUCTIONS

The exception behavior of VEX-encoded opmask instructions are listed below.

Exception conditions of Opmask instructions that do not address memory are listed as Type K20.

**Table 2-63. TYPE K20 Exception Definition (VEX-Encoded OpMask Instructions w/o Memory Arg)**

Exception	Real	Virtual 80x86	Protected and Compatibility	64-bit	Cause of Exception
Invalid Opcode, #UD	X	X	X	X	If relevant CPUID feature flag is '0'.
	X	X			If a VEX prefix is present.
			X	X	If CR4.OSXSAVE[bit 18]=0. If any one of following conditions applies: <ul style="list-style-type: none"> <li>▪ State requirement, Table 2-37 not met.</li> <li>▪ Opcode independent #UD condition in Table 2-38.</li> <li>▪ Operand encoding #UD conditions in Table 2-39.</li> </ul>
			X	X	If any REX, F2, F3, or 66 prefixes precede a VEX prefix.
			X	X	If ModRM:[7:6] != 11b.
Device Not Available, #NM	X	X	X	X	If CR0.TS[bit 3]=1.

Exception conditions of Opmask instructions that address memory are listed as Type K21.

**Table 2-64. TYPE K21 Exception Definition (VEX-Encoded OpMask Instructions Addressing Memory)**

Exception	Real	Virtual 80x86	Protected and Compatibility	64-bit	Cause of Exception
Invalid Opcode, #UD	X	X	X	X	If relevant CPUID feature flag is '0'.
	X	X			If a VEX prefix is present.
			X	X	If CR4.OSXSAVE[bit 18]=0. If any one of following conditions applies: <ul style="list-style-type: none"> <li>▪ State requirement, Table 2-37 not met.</li> <li>▪ Opcode independent #UD condition in Table 2-38.</li> <li>▪ Operand encoding #UD conditions in Table 2-39.</li> </ul>
Device Not Available, #NM	X	X	X	X	If CR0.TS[bit 3]=1.
			X	X	If any REX, F2, F3, or 66 prefixes precede a VEX prefix.
Stack, SS(0)	X	X	X		For an illegal address in the SS segment.
				X	If a memory address referencing the SS segment is in a non-canonical form.
General Protection, #GP(0)			X		For an illegal memory operand effective address in the CS, DS, ES, FS or GS segments. If the DS, ES, FS, or GS register is used to access memory and it contains a null segment selector.
				X	If the memory address is in a non-canonical form.
	X	X			If any part of the operand lies outside the effective address space from 0 to FFFFH.
Page Fault #PF(fault-code)		X	X	X	For a page fault.
Alignment Check #AC(0)		X	X	X	If alignment checking is enabled and an unaligned memory reference of 8 bytes or less is made while the current privilege level is 3.

## CHAPTER 3 INSTRUCTION SET REFERENCE, A-L

This chapter describes the instruction set for the Intel 64 and IA-32 architectures (A-L) in IA-32e, protected, virtual-8086, and real-address modes of operation. The set includes general-purpose, x87 FPU, MMX, SSE/SSE2/SSE3/SSSE3/SSE4, AESNI/PCLMULQDQ, AVX and system instructions. See also Chapter 4, “Instruction Set Reference, M-U,” in the *Intel® 64 and IA-32 Architectures Software Developer’s Manual, Volume 2B*, and Chapter 5, “Instruction Set Reference, V-Z,” in the *Intel® 64 and IA-32 Architectures Software Developer’s Manual, Volume 2C*.

For each instruction, each operand combination is described. A description of the instruction and its operand, an operational description, a description of the effect of the instructions on flags in the EFLAGS register, and a summary of exceptions that can be generated are also provided.

### 3.1 INTERPRETING THE INSTRUCTION REFERENCE PAGES

This section describes the format of information contained in the instruction reference pages in this chapter. It explains notational conventions and abbreviations used in these sections.

#### 3.1.1 Instruction Format

The following is an example of the format used for each instruction description in this chapter. The heading below introduces the example. The table below provides an example summary table.

#### CMC—Complement Carry Flag [this is an example]

Opcode	Instruction	Op/En	64/32-bit Mode	CPUID Feature Flag	Description
F5	CMC	Z0	V/V	NA	Complement carry flag.

#### Instruction Operand Encoding

Op/En	Operand 1	Operand 2	Operand 3	Operand 4
Z0	NA	NA	NA	NA

### 3.1.1.1 Opcode Column in the Instruction Summary Table (Instructions without VEX Prefix)

The “Opcode” column in the table above shows the object code produced for each form of the instruction. When possible, codes are given as hexadecimal bytes in the same order in which they appear in memory. Definitions of entries other than hexadecimal bytes are as follows:

- **NP** — Indicates the use of 66/F2/F3 prefixes (beyond those already part of the instructions opcode) are not allowed with the instruction. Such use will either cause an invalid-opcode exception (#UD) or result in the encoding for a different instruction.
- **REX.W** — Indicates the use of a REX prefix that affects operand size or instruction semantics. The ordering of the REX prefix and other optional/mandatory instruction prefixes are discussed Chapter 2. Note that REX prefixes that promote legacy instructions to 64-bit behavior are not listed explicitly in the opcode column.
- **/digit** — A digit between 0 and 7 indicates that the ModR/M byte of the instruction uses only the r/m (register or memory) operand. The reg field contains the digit that provides an extension to the instruction's opcode.
- **/r** — Indicates that the ModR/M byte of the instruction contains a register operand and an r/m operand.
- **cb, cw, cd, cp, co, ct** — A 1-byte (cb), 2-byte (cw), 4-byte (cd), 6-byte (cp), 8-byte (co) or 10-byte (ct) value following the opcode. This value is used to specify a code offset and possibly a new value for the code segment register.
- **ib, iw, id, io** — A 1-byte (ib), 2-byte (iw), 4-byte (id) or 8-byte (io) immediate operand to the instruction that follows the opcode, ModR/M bytes or scale-indexing bytes. The opcode determines if the operand is a signed value. All words, doublewords and quadwords are given with the low-order byte first.
- **+rb, +rw, +rd, +ro** — Indicated the lower 3 bits of the opcode byte is used to encode the register operand without a modR/M byte. The instruction lists the corresponding hexadecimal value of the opcode byte with low 3 bits as 000b. In non-64-bit mode, a register code, from 0 through 7, is added to the hexadecimal value of the opcode byte. In 64-bit mode, indicates the four bit field of REX.b and opcode[2:0] field encodes the register operand of the instruction. “+ro” is applicable only in 64-bit mode. See Table 3-1 for the codes.
- **+i** — A number used in floating-point instructions when one of the operands is ST(i) from the FPU register stack. The number i (which can range from 0 to 7) is added to the hexadecimal byte given at the left of the plus sign to form a single opcode byte.

**Table 3-1. Register Codes Associated With +rb, +rw, +rd, +ro**

byte register			word register			dword register			quadword register (64-Bit Mode only)		
Register	REX.B	Reg Field	Register	REX.B	Reg Field	Register	REX.B	Reg Field	Register	REX.B	Reg Field
AL	None	0	AX	None	0	EAX	None	0	RAX	None	0
CL	None	1	CX	None	1	ECX	None	1	RCX	None	1
DL	None	2	DX	None	2	EDX	None	2	RDX	None	2
BL	None	3	BX	None	3	EBX	None	3	RBX	None	3
AH	Not encodable (N.E.)	4	SP	None	4	ESP	None	4	N/A	N/A	N/A
CH	N.E.	5	BP	None	5	EBP	None	5	N/A	N/A	N/A
DH	N.E.	6	SI	None	6	ESI	None	6	N/A	N/A	N/A
BH	N.E.	7	DI	None	7	EDI	None	7	N/A	N/A	N/A
SPL	Yes	4	SP	None	4	ESP	None	4	RSP	None	4
BPL	Yes	5	BP	None	5	EBP	None	5	RBP	None	5
SIL	Yes	6	SI	None	6	ESI	None	6	RSI	None	6
DIL	Yes	7	DI	None	7	EDI	None	7	RDI	None	7

Registers R8 - R15 (see below): Available in 64-Bit Mode Only



Table 3-1. Register Codes Associated With +rb, +rw, +rd, +ro (Contd.)

byte register			word register			dword register			quadword register (64-Bit Mode only)		
Register	REX.B	Reg Field	Register	REX.B	Reg Field	Register	REX.B	Reg Field	Register	REX.B	Reg Field
R8L	Yes	0	R8W	Yes	0	R8D	Yes	0	R8	Yes	0
R9L	Yes	1	R9W	Yes	1	R9D	Yes	1	R9	Yes	1
R10L	Yes	2	R10W	Yes	2	R10D	Yes	2	R10	Yes	2
R11L	Yes	3	R11W	Yes	3	R11D	Yes	3	R11	Yes	3
R12L	Yes	4	R12W	Yes	4	R12D	Yes	4	R12	Yes	4
R13L	Yes	5	R13W	Yes	5	R13D	Yes	5	R13	Yes	5
R14L	Yes	6	R14W	Yes	6	R14D	Yes	6	R14	Yes	6
R15L	Yes	7	R15W	Yes	7	R15D	Yes	7	R15	Yes	7

### 3.1.1.2 Opcode Column in the Instruction Summary Table (Instructions with VEX prefix)

In the Instruction Summary Table, the Opcode column presents each instruction encoded using the VEX prefix in following form (including the modR/M byte if applicable, the immediate byte if applicable):

VEX.[NDS].[128,256].[66,F2,F3].OF/OF3A/OF38.[WO,W1] opcode [/r] [/ib,/is4]

- **VEX** — Indicates the presence of the VEX prefix is required. The VEX prefix can be encoded using the three-byte form (the first byte is C4H), or using the two-byte form (the first byte is C5H). The two-byte form of VEX only applies to those instructions that do not require the following fields to be encoded: VEX.mmmmm, VEX.W, VEX.X, VEX.B. Refer to Section 2.3 for more detail on the VEX prefix.

The encoding of various sub-fields of the VEX prefix is described using the following notations:

- **NDS, NDD, DDS**: Specifies that VEX.vvvv field is valid for the encoding of a register operand:
  - **VEX.NDS**: VEX.vvvv encodes the first source register in an instruction syntax where the content of source registers will be preserved.
  - **VEX.NDD**: VEX.vvvv encodes the destination register that cannot be encoded by ModR/M:reg field.
  - **VEX.DDS**: VEX.vvvv encodes the second source register in a three-operand instruction syntax where the content of first source register will be overwritten by the result.
  - If none of NDS, NDD, and DDS is present, VEX.vvvv must be 1111b (i.e. VEX.vvvv does not encode an operand). The VEX.vvvv field can be encoded using either the 2-byte or 3-byte form of the VEX prefix.
- **128,256**: VEX.L field can be 0 (denoted by VEX.128 or VEX.LZ) or 1 (denoted by VEX.256). The VEX.L field can be encoded using either the 2-byte or 3-byte form of the VEX prefix. The presence of the notation VEX.256 or VEX.128 in the opcode column should be interpreted as follows:
  - If VEX.256 is present in the opcode column: The semantics of the instruction must be encoded with VEX.L = 1. An attempt to encode this instruction with VEX.L = 0 can result in one of two situations: (a) if VEX.128 version is defined, the processor will behave according to the defined VEX.128 behavior; (b) an #UD occurs if there is no VEX.128 version defined.
  - If VEX.128 is present in the opcode column but there is no VEX.256 version defined for the same opcode byte: Two situations apply: (a) For VEX-encoded, 128-bit SIMD integer instructions, software must encode the instruction with VEX.L = 0. The processor will treat the opcode byte encoded with VEX.L = 1 by causing an #UD exception; (b) For VEX-encoded, 128-bit packed floating-point instructions, software must encode the instruction with VEX.L = 0. The processor will treat the opcode byte encoded with VEX.L = 1 by causing an #UD exception (e.g. VMOVLPS).
  - If VEX.LIG is present in the opcode column: The VEX.L value is ignored. This generally applies to VEX-encoded scalar SIMD floating-point instructions. Scalar SIMD floating-point instruction can be distin-

guished from the mnemonic of the instruction. Generally, the last two letters of the instruction mnemonic would be either "SS", "SD", or "SI" for SIMD floating-point conversion instructions.

- If VEX.LZ is present in the opcode column: The VEX.L must be encoded to be 0B, an #UD occurs if VEX.L is not zero.
- **66,F2,F3**: The presence or absence of these values map to the VEX.pp field encodings. If absent, this corresponds to VEX.pp=00B. If present, the corresponding VEX.pp value affects the "opcode" byte in the same way as if a SIMD prefix (66H, F2H or F3H) does to the ensuing opcode byte. Thus a non-zero encoding of VEX.pp may be considered as an implied 66H/F2H/F3H prefix. The VEX.pp field may be encoded using either the 2-byte or 3-byte form of the VEX prefix.
- **0F,0F3A,0F38**: The presence maps to a valid encoding of the VEX.mmmmm field. Only three encoded values of VEX.mmmmm are defined as valid, corresponding to the escape byte sequence of 0FH, 0F3AH and 0F38H. The effect of a valid VEX.mmmmm encoding on the ensuing opcode byte is same as if the corresponding escape byte sequence on the ensuing opcode byte for non-VEX encoded instructions. Thus a valid encoding of VEX.mmmmm may be consider as an implies escape byte sequence of either 0FH, 0F3AH or 0F38H. The VEX.mmmmm field must be encoded using the 3-byte form of VEX prefix.
- **0F,0F3A,0F38 and 2-byte/3-byte VEX**: The presence of 0F3A and 0F38 in the opcode column implies that opcode can only be encoded by the three-byte form of VEX. The presence of 0F in the opcode column does not preclude the opcode to be encoded by the two-byte of VEX if the semantics of the opcode does not require any subfield of VEX not present in the two-byte form of the VEX prefix.
- **W0**: VEX.W=0.
- **W1**: VEX.W=1.
- The presence of W0/W1 in the opcode column applies to two situations: (a) it is treated as an extended opcode bit, (b) the instruction semantics support an operand size promotion to 64-bit of a general-purpose register operand or a 32-bit memory operand. The presence of W1 in the opcode column implies the opcode must be encoded using the 3-byte form of the VEX prefix. The presence of W0 in the opcode column does not preclude the opcode to be encoded using the C5H form of the VEX prefix, if the semantics of the opcode does not require other VEX subfields not present in the two-byte form of the VEX prefix. Please see Section 2.3 on the subfield definitions within VEX.
- **WIG**: can use C5H form (if not requiring VEX.mmmmm) or VEX.W value is ignored in the C4H form of VEX prefix.
- If WIG is present, the instruction may be encoded using either the two-byte form or the three-byte form of VEX. When encoding the instruction using the three-byte form of VEX, the value of VEX.W is ignored.
- **opcode** — Instruction opcode.
- **/is4** — An 8-bit immediate byte is present containing a source register specifier in either imm8[7:4] (for 64-bit mode) or imm8[6:4] (for 32-bit mode), and instruction-specific payload in imm8[3:0].
- In general, the encoding of f VEX.R, VEX.X, VEX.B field are not shown explicitly in the opcode column. The encoding scheme of VEX.R, VEX.X, VEX.B fields must follow the rules defined in Section 2.3.

**EVEX.[NDS/NDD/DDS].[128,256,512,LIG].[66,F2,F3].0F/0F3A/0F38.[W0,W1,WIG] opcode [/r] [ib]**

- **EVEX** — The EVEX prefix is encoded using the four-byte form (the first byte is 62H). Refer to Section 2.6.1 for more detail on the EVEX prefix.

The encoding of various sub-fields of the EVEX prefix is described using the following notations:

- **NDS, NDD, DDS**: implies that EVEX.vvvv (and EVEX.v') field is valid for the encoding of an operand. It may specify either the source register (NDS) or the destination register (NDD). DDS expresses a syntax where vvvv encodes the second source register in a three-operand instruction syntax where the content of first source register will be overwritten by the result. If both NDS and NDD absent (i.e. EVEX.vvvv does not encode an operand), EVEX.vvvv must be 1111b (and EVEX.v' must be 1b).
- **128, 256, 512, LIG**: This corresponds to the vector length; three values are allowed by EVEX: 512-bit, 256-bit and 128-bit. Alternatively, vector length is ignored (LIG) for certain instructions; this typically applies to scalar instructions operating on one data element of a vector register.

- **66,F2,F3**: The presence of these value maps to the EVEX.pp field encodings. The corresponding VEX.pp value affects the “opcode” byte in the same way as if a SIMD prefix (66H, F2H or F3H) does to the ensuing opcode byte. Thus a non-zero encoding of VEX.pp may be considered as an implied 66H/F2H/F3H prefix.
- **0F,0F3A,0F38**: The presence maps to a valid encoding of the EVEX.mmm field. Only three encoded values of EVEX.mmm are defined as valid, corresponding to the escape byte sequence of 0FH, 0F3AH and 0F38H. The effect of a valid EVEX.mmm encoding on the ensuing opcode byte is the same as if the corresponding escape byte sequence on the ensuing opcode byte for non-EVEX encoded instructions. Thus a valid encoding of EVEX.mmm may be considered as an implied escape byte sequence of either 0FH, 0F3AH or 0F38H.
- **W0**: EVEX.W=0.
- **W1**: EVEX.W=1.
- **WIG**: EVEX.W bit ignored
- **opcode** — Instruction opcode.
- In general, the encoding of EVEX.R and R', EVEX.X and X', and EVEX.B and B' fields are not shown explicitly in the opcode column.

### 3.1.1.3 Instruction Column in the Opcode Summary Table

The “Instruction” column gives the syntax of the instruction statement as it would appear in an ASM386 program. The following is a list of the symbols used to represent operands in the instruction statements:

- **rel8** — A relative address in the range from 128 bytes before the end of the instruction to 127 bytes after the end of the instruction.
- **rel16, rel32** — A relative address within the same code segment as the instruction assembled. The rel16 symbol applies to instructions with an operand-size attribute of 16 bits; the rel32 symbol applies to instructions with an operand-size attribute of 32 bits.
- **ptr16:16, ptr16:32** — A far pointer, typically to a code segment different from that of the instruction. The notation *16:16* indicates that the value of the pointer has two parts. The value to the left of the colon is a 16-bit selector or value destined for the code segment register. The value to the right corresponds to the offset within the destination segment. The ptr16:16 symbol is used when the instruction's operand-size attribute is 16 bits; the ptr16:32 symbol is used when the operand-size attribute is 32 bits.
- **r8** — One of the byte general-purpose registers: AL, CL, DL, BL, AH, CH, DH, BH, BPL, SPL, DIL and SIL; or one of the byte registers (R8L - R15L) available when using REX.R and 64-bit mode.
- **r16** — One of the word general-purpose registers: AX, CX, DX, BX, SP, BP, SI, DI; or one of the word registers (R8-R15) available when using REX.R and 64-bit mode.
- **r32** — One of the doubleword general-purpose registers: EAX, ECX, EDX, EBX, ESP, EBP, ESI, EDI; or one of the doubleword registers (R8D - R15D) available when using REX.R in 64-bit mode.
- **r64** — One of the quadword general-purpose registers: RAX, RBX, RCX, RDX, RDI, RSI, RBP, RSP, R8-R15. These are available when using REX.R and 64-bit mode.
- **imm8** — An immediate byte value. The imm8 symbol is a signed number between -128 and +127 inclusive. For instructions in which imm8 is combined with a word or doubleword operand, the immediate value is sign-extended to form a word or doubleword. The upper byte of the word is filled with the topmost bit of the immediate value.
- **imm16** — An immediate word value used for instructions whose operand-size attribute is 16 bits. This is a number between -32,768 and +32,767 inclusive.
- **imm32** — An immediate doubleword value used for instructions whose operand-size attribute is 32 bits. It allows the use of a number between +2,147,483,647 and -2,147,483,648 inclusive.
- **imm64** — An immediate quadword value used for instructions whose operand-size attribute is 64 bits. The value allows the use of a number between +9,223,372,036,854,775,807 and -9,223,372,036,854,775,808 inclusive.

- **r/m8** — A byte operand that is either the contents of a byte general-purpose register (AL, CL, DL, BL, AH, CH, DH, BH, BPL, SPL, DIL and SIL) or a byte from memory. Byte registers R8L - R15L are available using REX.R in 64-bit mode.
- **r/m16** — A word general-purpose register or memory operand used for instructions whose operand-size attribute is 16 bits. The word general-purpose registers are: AX, CX, DX, BX, SP, BP, SI, DI. The contents of memory are found at the address provided by the effective address computation. Word registers R8W - R15W are available using REX.R in 64-bit mode.
- **r/m32** — A doubleword general-purpose register or memory operand used for instructions whose operand-size attribute is 32 bits. The doubleword general-purpose registers are: EAX, ECX, EDX, EBX, ESP, EBP, ESI, EDI. The contents of memory are found at the address provided by the effective address computation. Doubleword registers R8D - R15D are available when using REX.R in 64-bit mode.
- **r/m64** — A quadword general-purpose register or memory operand used for instructions whose operand-size attribute is 64 bits when using REX.W. Quadword general-purpose registers are: RAX, RBX, RCX, RDX, RDI, RSI, RBP, RSP, R8–R15; these are available only in 64-bit mode. The contents of memory are found at the address provided by the effective address computation.
- **m** — A 16-, 32- or 64-bit operand in memory.
- **m8** — A byte operand in memory, usually expressed as a variable or array name, but pointed to by the DS:(E)SI or ES:(E)DI registers. In 64-bit mode, it is pointed to by the RSI or RDI registers.
- **m16** — A word operand in memory, usually expressed as a variable or array name, but pointed to by the DS:(E)SI or ES:(E)DI registers. This nomenclature is used only with the string instructions.
- **m32** — A doubleword operand in memory, usually expressed as a variable or array name, but pointed to by the DS:(E)SI or ES:(E)DI registers. This nomenclature is used only with the string instructions.
- **m64** — A memory quadword operand in memory.
- **m128** — A memory double quadword operand in memory.
- **m16:16, m16:32 & m16:64** — A memory operand containing a far pointer composed of two numbers. The number to the left of the colon corresponds to the pointer's segment selector. The number to the right corresponds to its offset.
- **m16&32, m16&16, m32&32, m16&64** — A memory operand consisting of data item pairs whose sizes are indicated on the left and the right side of the ampersand. All memory addressing modes are allowed. The m16&16 and m32&32 operands are used by the BOUND instruction to provide an operand containing an upper and lower bounds for array indices. The m16&32 operand is used by LIDT and LGDT to provide a word with which to load the limit field, and a doubleword with which to load the base field of the corresponding GDTR and IDTR registers. The m16&64 operand is used by LIDT and LGDT in 64-bit mode to provide a word with which to load the limit field, and a quadword with which to load the base field of the corresponding GDTR and IDTR registers.
- **m80bcd**— A Binary Coded Decimal (BCD) operand in memory, 80 bits.
- **moffs8, moffs16, moffs32, moffs64** — A simple memory variable (memory offset) of type byte, word, or doubleword used by some variants of the MOV instruction. The actual address is given by a simple offset relative to the segment base. No ModR/M byte is used in the instruction. The number shown with moffs indicates its size, which is determined by the address-size attribute of the instruction.
- **Sreg** — A segment register. The segment register bit assignments are ES = 0, CS = 1, SS = 2, DS = 3, FS = 4, and GS = 5.
- **m32fp, m64fp, m80fp** — A single-precision, double-precision, and double extended-precision (respectively) floating-point operand in memory. These symbols designate floating-point values that are used as operands for x87 FPU floating-point instructions.
- **m16int, m32int, m64int** — A word, doubleword, and quadword integer (respectively) operand in memory. These symbols designate integers that are used as operands for x87 FPU integer instructions.
- **ST or ST(0)** — The top element of the FPU register stack.
- **ST(i)** — The *i*<sup>th</sup> element from the top of the FPU register stack (*i* ← 0 through 7).
- **mm** — An MMX register. The 64-bit MMX registers are: MM0 through MM7.

- **mm/m32** — The low order 32 bits of an MMX register or a 32-bit memory operand. The 64-bit MMX registers are: MM0 through MM7. The contents of memory are found at the address provided by the effective address computation.
- **mm/m64** — An MMX register or a 64-bit memory operand. The 64-bit MMX registers are: MM0 through MM7. The contents of memory are found at the address provided by the effective address computation.
- **xmm** — An XMM register. The 128-bit XMM registers are: XMM0 through XMM7; XMM8 through XMM15 are available using REX.R in 64-bit mode.
- **xmm/m32** — An XMM register or a 32-bit memory operand. The 128-bit XMM registers are XMM0 through XMM7; XMM8 through XMM15 are available using REX.R in 64-bit mode. The contents of memory are found at the address provided by the effective address computation.
- **xmm/m64** — An XMM register or a 64-bit memory operand. The 128-bit SIMD floating-point registers are XMM0 through XMM7; XMM8 through XMM15 are available using REX.R in 64-bit mode. The contents of memory are found at the address provided by the effective address computation.
- **xmm/m128** — An XMM register or a 128-bit memory operand. The 128-bit XMM registers are XMM0 through XMM7; XMM8 through XMM15 are available using REX.R in 64-bit mode. The contents of memory are found at the address provided by the effective address computation.
- **<XMM0>** — Indicates implied use of the XMM0 register.  
When there is ambiguity, **xmm1** indicates the first source operand using an XMM register and **xmm2** the second source operand using an XMM register.  
Some instructions use the XMM0 register as the third source operand, indicated by **<XMM0>**. The use of the third XMM register operand is implicit in the instruction encoding and does not affect the ModR/M encoding.
- **ymm** — A YMM register. The 256-bit YMM registers are: YMM0 through YMM7; YMM8 through YMM15 are available in 64-bit mode.
- **m256** — A 32-byte operand in memory. This nomenclature is used only with AVX instructions.
- **ymm/m256** — A YMM register or 256-bit memory operand.
- **<YMM0>** — Indicates use of the YMM0 register as an implicit argument.
- **bnd** — A 128-bit bounds register. BND0 through BND3.
- **mib** — A memory operand using SIB addressing form, where the index register is not used in address calculation, Scale is ignored. Only the base and displacement are used in effective address calculation.
- **m512** — A 64-byte operand in memory.
- **zmm/m512** — A ZMM register or 512-bit memory operand.
- **{k1}{z}** — A mask register used as instruction writemask. The 64-bit k registers are: k1 through k7. Writemask specification is available exclusively via EVEX prefix. The masking can either be done as a merging-masking, where the old values are preserved for masked out elements or as a zeroing masking. The type of masking is determined by using the EVEX.z bit.
- **{k1}** — Without {z}: a mask register used as instruction writemask for instructions that do not allow zeroing-masking but support merging-masking. This corresponds to instructions that require the value of the aaa field to be different than 0 (e.g., gather) and store-type instructions which allow only merging-masking.
- **k1** — A mask register used as a regular operand (either destination or source). The 64-bit k registers are: k0 through k7.
- **mV** — A vector memory operand; the operand size is dependent on the instruction.
- **vm32{x,y,z}** — A vector array of memory operands specified using VSIB memory addressing. The array of memory addresses are specified using a common base register, a constant scale factor, and a vector index register with individual elements of 32-bit index value in an XMM register (vm32x), a YMM register (vm32y) or a ZMM register (vm32z).
- **vm64{x,y,z}** — A vector array of memory operands specified using VSIB memory addressing. The array of memory addresses are specified using a common base register, a constant scale factor, and a vector index register with individual elements of 64-bit index value in an XMM register (vm64x), a YMM register (vm64y) or a ZMM register (vm64z).

- **zmm/m512/m32bcst** — An operand that can be a ZMM register, a 512-bit memory location or a 512-bit vector loaded from a 32-bit memory location.
- **zmm/m512/m64bcst** — An operand that can be a ZMM register, a 512-bit memory location or a 512-bit vector loaded from a 64-bit memory location.
- **<ZMM0>** — Indicates use of the ZMM0 register as an implicit argument.
- **{er}** — Indicates support for embedded rounding control, which is only applicable to the register-register form of the instruction. This also implies support for SAE (Suppress All Exceptions).
- **{sae}** — Indicates support for SAE (Suppress All Exceptions). This is used for instructions that support SAE, but do not support embedded rounding control.
- **SRC1** — Denotes the first source operand in the instruction syntax of an instruction encoded with the VEX/EVEX prefix and having two or more source operands.
- **SRC2** — Denotes the second source operand in the instruction syntax of an instruction encoded with the VEX/EVEX prefix and having two or more source operands.
- **SRC3** — Denotes the third source operand in the instruction syntax of an instruction encoded with the VEX/EVEX prefix and having three source operands.
- **SRC** — The source in a single-source instruction.
- **DST** — the destination in an instruction. This field is encoded by `reg_field`.

### 3.1.1.4 Operand Encoding Column in the Instruction Summary Table

The “operand encoding” column is abbreviated as Op/En in the Instruction Summary table heading. Instruction operand encoding information is provided for each assembly instruction syntax using a letter to cross reference to a row entry in the operand encoding definition table that follows the instruction summary table. The operand encoding table in each instruction reference page lists each instruction operand (according to each instruction syntax and operand ordering shown in the instruction column) relative to the ModRM byte, VEX.vvvv field or additional operand encoding placement.

EVEX encoded instructions employ compressed `disp8*N` encoding of the displacement bytes, where N is defined in Table 2-34 and Table 2-35, according to tuple types. The tuple type for an instruction is listed in the operand encoding definition table where applicable.

#### NOTES

- The letters in the Op/En column of an instruction apply **ONLY** to the encoding definition table immediately following the instruction summary table.
- In the encoding definition table, the letter ‘r’ within a pair of parenthesis denotes the content of the operand will be read by the processor. The letter ‘w’ within a pair of parenthesis denotes the content of the operand will be updated by the processor.

### 3.1.1.5 64/32-bit Mode Column in the Instruction Summary Table

The “64/32-bit Mode” column indicates whether the opcode sequence is supported in (a) 64-bit mode or (b) the Compatibility mode and other IA-32 modes that apply in conjunction with the CPUID feature flag associated specific instruction extensions.

The 64-bit mode support is to the left of the ‘slash’ and has the following notation:

- **V** — Supported.
- **I** — Not supported.
- **N.E.** — Indicates an instruction syntax is not encodable in 64-bit mode (it may represent part of a sequence of valid instructions in other modes).
- **N.P.** — Indicates the REX prefix does not affect the legacy instruction in 64-bit mode.
- **N.I.** — Indicates the opcode is treated as a new instruction in 64-bit mode.
- **N.S.** — Indicates an instruction syntax that requires an address override prefix in 64-bit mode and is not supported. Using an address override prefix in 64-bit mode may result in model-specific execution behavior.



The Compatibility/Legacy Mode support is to the right of the 'slash' and has the following notation:

- **V** — Supported.
- **I** — Not supported.
- **N.E.** — Indicates an Intel 64 instruction mnemonics/syntax that is not encodable; the opcode sequence is not applicable as an individual instruction in compatibility mode or IA-32 mode. The opcode may represent a valid sequence of legacy IA-32 instructions.

### 3.1.1.6 CPUID Support Column in the Instruction Summary Table

The fourth column holds abbreviated CPUID feature flags (e.g., appropriate bit in CPUID.1.ECX, CPUID.1.EDX for SSE/SSE2/SSE3/SSSE3/SSE4.1/SSE4.2/AESNI/PCLMULQDQ/AVX/RDRAND support) that indicate processor support for the instruction. If the corresponding flag is '0', the instruction will #UD.

### 3.1.1.7 Description Column in the Instruction Summary Table

The "Description" column briefly explains forms of the instruction.

### 3.1.1.8 Description Section

Each instruction is then described by number of information sections. The "Description" section describes the purpose of the instructions and required operands in more detail.

Summary of terms that may be used in the description section:

- **Legacy SSE** — Refers to SSE, SSE2, SSE3, SSSE3, SSE4, AESNI, PCLMULQDQ and any future instruction sets referencing XMM registers and encoded without a VEX prefix.
- **VEX.vvvv** — The VEX bit field specifying a source or destination register (in 1's complement form).
- **rm\_field** — shorthand for the ModR/M *r/m* field and any REX.B
- **reg\_field** — shorthand for the ModR/M *reg* field and any REX.R

### 3.1.1.9 Operation Section

The "Operation" section contains an algorithm description (frequently written in pseudo-code) for the instruction. Algorithms are composed of the following elements:

- Comments are enclosed within the symbol pairs "(" and "\*".
- Compound statements are enclosed in keywords, such as: IF, THEN, ELSE and FI for an if statement; DO and OD for a do statement; or CASE... OF for a case statement.
- A register name implies the contents of the register. A register name enclosed in brackets implies the contents of the location whose address is contained in that register. For example, ES:[DI] indicates the contents of the location whose ES segment relative address is in register DI. [SI] indicates the contents of the address contained in register SI relative to the SI register's default segment (DS) or the overridden segment.
- Parentheses around the "E" in a general-purpose register name, such as (E)SI, indicates that the offset is read from the SI register if the address-size attribute is 16, from the ESI register if the address-size attribute is 32. Parentheses around the "R" in a general-purpose register name, (R)SI, in the presence of a 64-bit register definition such as (R)SI, indicates that the offset is read from the 64-bit RSI register if the address-size attribute is 64.
- Brackets are used for memory operands where they mean that the contents of the memory location is a segment-relative offset. For example, [SRC] indicates that the content of the source operand is a segment-relative offset.
- $A \leftarrow B$  indicates that the value of B is assigned to A.
- The symbols =, ≠, >, <, ≥, and ≤ are relational operators used to compare two values: meaning equal, not equal, greater or equal, less or equal, respectively. A relational expression such as  $A = B$  is TRUE if the value of A is equal to B; otherwise it is FALSE.



- The expression “« COUNT” and “» COUNT” indicates that the destination operand should be shifted left or right by the number of bits indicated by the count operand.

The following identifiers are used in the algorithmic descriptions:

- **OperandSize and AddressSize** — The **OperandSize** identifier represents the operand-size attribute of the instruction, which is 16, 32 or 64-bits. The **AddressSize** identifier represents the address-size attribute, which is 16, 32 or 64-bits. For example, the following pseudo-code indicates that the operand-size attribute depends on the form of the MOV instruction used.

```

IF Instruction = MOVW
    THEN OperandSize ← 16;
ELSE
    IF Instruction = MOVD
        THEN OperandSize ← 32;
    ELSE
        IF Instruction = MOVQ
            THEN OperandSize ← 64;
        FI;
    FI;
FI;

```

See “Operand-Size and Address-Size Attributes” in Chapter 3 of the *Intel® 64 and IA-32 Architectures Software Developer’s Manual, Volume 1*, for guidelines on how these attributes are determined.

- **StackAddrSize** — Represents the stack address-size attribute associated with the instruction, which has a value of 16, 32 or 64-bits. See “Address-Size Attribute for Stack” in Chapter 6, “Procedure Calls, Interrupts, and Exceptions,” of the *Intel® 64 and IA-32 Architectures Software Developer’s Manual, Volume 1*.
- **SRC** — Represents the source operand.
- **DEST** — Represents the destination operand.
- **MAXVL** — The maximum vector register width pertaining to the instruction. This is not the vector-length encoding in the instruction’s encoding but is instead determined by the current value of XCR0. For details, refer to the table below. Note that the value of MAXVL is the largest of the features enabled. Future processors may define new bits in XCR0 whose setting may imply other values for MAXVL.

#### MAXVL Definition

XCR0 Component	MAXVL
XCR0.SSE	128
XCR0.AVX	256
XCR0.{ZMM_Hi256, Hi16_ZMM, OPMASK}	512

The following functions are used in the algorithmic descriptions:

- **ZeroExtend(value)** — Returns a value zero-extended to the operand-size attribute of the instruction. For example, if the operand-size attribute is 32, zero extending a byte value of –10 converts the byte from F6H to a doubleword value of 000000F6H. If the value passed to the ZeroExtend function and the operand-size attribute are the same size, ZeroExtend returns the value unaltered.
- **SignExtend(value)** — Returns a value sign-extended to the operand-size attribute of the instruction. For example, if the operand-size attribute is 32, sign extending a byte containing the value –10 converts the byte from F6H to a doubleword value of FFFFFFF6H. If the value passed to the SignExtend function and the operand-size attribute are the same size, SignExtend returns the value unaltered.
- **SaturateSignedWordToSignedByte** — Converts a signed 16-bit value to a signed 8-bit value. If the signed 16-bit value is less than –128, it is represented by the saturated value –128 (80H); if it is greater than 127, it is represented by the saturated value 127 (7FH).

- **SaturateSignedDwordToSignedWord** — Converts a signed 32-bit value to a signed 16-bit value. If the signed 32-bit value is less than  $-32768$ , it is represented by the saturated value  $-32768$  (8000H); if it is greater than  $32767$ , it is represented by the saturated value  $32767$  (7FFFH).
- **SaturateSignedWordToUnsignedByte** — Converts a signed 16-bit value to an unsigned 8-bit value. If the signed 16-bit value is less than zero, it is represented by the saturated value zero (00H); if it is greater than 255, it is represented by the saturated value 255 (FFH).
- **SaturateToSignedByte** — Represents the result of an operation as a signed 8-bit value. If the result is less than  $-128$ , it is represented by the saturated value  $-128$  (80H); if it is greater than 127, it is represented by the saturated value 127 (7FH).
- **SaturateToSignedWord** — Represents the result of an operation as a signed 16-bit value. If the result is less than  $-32768$ , it is represented by the saturated value  $-32768$  (8000H); if it is greater than  $32767$ , it is represented by the saturated value  $32767$  (7FFFH).
- **SaturateToUnsignedByte** — Represents the result of an operation as a signed 8-bit value. If the result is less than zero it is represented by the saturated value zero (00H); if it is greater than 255, it is represented by the saturated value 255 (FFH).
- **SaturateToUnsignedWord** — Represents the result of an operation as a signed 16-bit value. If the result is less than zero it is represented by the saturated value zero (00H); if it is greater than 65535, it is represented by the saturated value 65535 (FFFFH).
- **LowOrderWord(DEST \* SRC)** — Multiplies a word operand by a word operand and stores the least significant word of the doubleword result in the destination operand.
- **HighOrderWord(DEST \* SRC)** — Multiplies a word operand by a word operand and stores the most significant word of the doubleword result in the destination operand.
- **Push(value)** — Pushes a value onto the stack. The number of bytes pushed is determined by the operand-size attribute of the instruction. See the "Operation" subsection of the "PUSH—Push Word, Doubleword or Quadword Onto the Stack" section in Chapter 4 of the *Intel® 64 and IA-32 Architectures Software Developer's Manual, Volume 2B*.
- **Pop()** — removes the value from the top of the stack and returns it. The statement  $EAX \leftarrow \text{Pop}()$ ; assigns to EAX the 32-bit value from the top of the stack. Pop will return either a word, a doubleword or a quadword depending on the operand-size attribute. See the "Operation" subsection in the "POP—Pop a Value from the Stack" section of Chapter 4 of the *Intel® 64 and IA-32 Architectures Software Developer's Manual, Volume 2B*.
- **PopRegisterStack** — Marks the FPU ST(0) register as empty and increments the FPU register stack pointer (TOP) by 1.
- **Switch-Tasks** — Performs a task switch.
- **Bit(BitBase, BitOffset)** — Returns the value of a bit within a bit string. The bit string is a sequence of bits in memory or a register. Bits are numbered from low-order to high-order within registers and within memory bytes. If the BitBase is a register, the BitOffset can be in the range 0 to [15, 31, 63] depending on the mode and register size. See Figure 3-1: the function  $\text{Bit}[RAX, 21]$  is illustrated.

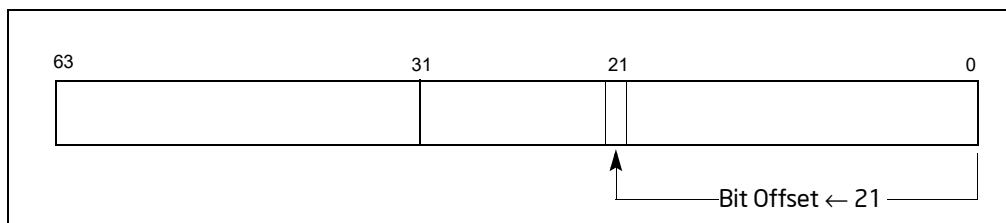

**Figure 3-1. Bit Offset for BIT[RAX, 21]**

If BitBase is a memory address, the BitOffset has different ranges depending on the operand size (see Table 3-2).

**Table 3-2. Range of Bit Positions Specified by Bit Offset Operands**

Operand Size	Immediate BitOffset	Register BitOffset
16	0 to 15	$-2^{15}$ to $2^{15} - 1$
32	0 to 31	$-2^{31}$ to $2^{31} - 1$
64	0 to 63	$-2^{63}$ to $2^{63} - 1$

The addressed bit is numbered (Offset MOD 8) within the byte at address (BitBase + (BitOffset DIV 8)) where DIV is signed division with rounding towards negative infinity and MOD returns a positive number (see Figure 3-2).

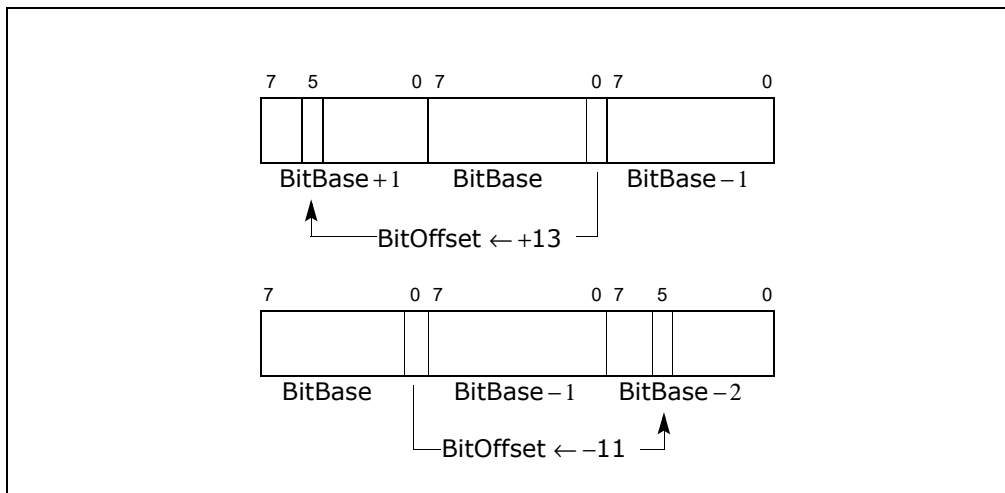

**Figure 3-2. Memory Bit Indexing**

### 3.1.1.10 Intel® C/C++ Compiler Intrinsics Equivalents Section

The Intel C/C++ compiler intrinsic functions give access to the full power of the Intel Architecture Instruction Set, while allowing the compiler to optimize register allocation and instruction scheduling for faster execution. Most of these functions are associated with a single IA instruction, although some may generate multiple instructions or different instructions depending upon how they are used. In particular, these functions are used to invoke instructions that perform operations on vector registers that can hold multiple data elements. These SIMD instructions use the following data types.

- `__m128`, `__m256` and `__m512` can represent 4, 8 or 16 packed single-precision floating-point values, and are used with the vector registers and SSE, AVX, or AVX-512 instruction set extension families. The `__m128` data type is also used with various single-precision floating-point scalar instructions that perform calculations using only the lowest 32 bits of a vector register; the remaining bits of the result come from one of the sources or are set to zero depending upon the instruction.
- `__m128d`, `__m256d` and `__m512d` can represent 2, 4 or 8 packed double-precision floating-point values, and are used with the vector registers and SSE, AVX, or AVX-512 instruction set extension families. The `__m128d` data type is also used with various double-precision floating-point scalar instructions that perform calculations using only the lowest 64 bits of a vector register; the remaining bits of the result come from one of the sources or are set to zero depending upon the instruction.
- `__m128i`, `__m256i` and `__m512i` can represent integer data in bytes, words, doublewords, quadwords, and occasionally larger data types.

Each of these data types incorporates in its name the number of bits it can hold. For example, the `__m128` type holds 128 bits, and because each single-precision floating-point value is 32 bits long the `__m128` type holds (128/32) or four values. Normally the compiler will allocate memory for these data types on an even multiple of the size of the type. Such aligned memory locations may be faster to read and write than locations at other addresses.

These SIMD data types are not basic Standard C data types or C++ objects, so they may be used only with the assignment operator, passed as function arguments, and returned from a function call. If you access the internal members of these types directly, or indirectly by using them in a union, there may be side effects affecting optimization, so it is recommended to use them only with the SIMD instruction intrinsic functions described in this manual or the Intel C/C++ compiler documentation.

Many intrinsic functions names are prefixed with an indicator of the vector length and suffixed by an indicator of the vector element data type, although some functions do not follow the rules below. The prefixes are:

- `_mm_` indicates that the function operates on 128-bit (or sometimes 64-bit) vectors.
- `_mm256_` indicates the function operates on 256-bit vectors.
- `_mm512_` indicates that the function operates on 512-bit vectors.

The suffixes include:

- `_ps`, which indicates a function that operates on packed single-precision floating-point data. Packed single-precision floating-point data corresponds to arrays of the C/C++ type `float` with either 4, 8 or 16 elements. Values of this type can be loaded from an array using the `_mm_loadu_ps`, `_mm256_loadu_ps`, or `_mm512_loadu_ps` functions, or created from individual values using `_mm_set_ps`, `_mm256_set_ps`, or `_mm512_set_ps` functions, and they can be stored in an array using `_mm_storeu_ps`, `_mm256_storeu_ps`, or `_mm512_storeu_ps`.
- `_ss`, which indicates a function that operates on scalar single-precision floating-point data. Single-precision floating-point data corresponds to the C/C++ type `float`, and values of type `float` can be converted to type `__m128` for use with these functions using the `_mm_set_ss` function, and converted back using the `_mm_cvtss_f32` function. When used with functions that operate on packed single-precision floating-point data the scalar element corresponds with the first packed value.
- `_pd`, which indicates a function that operates on packed double-precision floating-point data. Packed double-precision floating-point data corresponds to arrays of the C/C++ type `double` with either 2, 4, or 8 elements. Values of this type can be loaded from an array using the `_mm_loadu_pd`, `_mm256_loadu_pd`, or `_mm512_loadu_pd` functions, or created from individual values using `_mm_set_pd`, `_mm256_set_pd`, or `_mm512_set_pd` functions, and they can be stored in an array using `_mm_storeu_pd`, `_mm256_storeu_pd`, or `_mm512_storeu_pd`.
- `_sd`, which indicates a function that operates on scalar double-precision floating-point data. Double-precision floating-point data corresponds to the C/C++ type `double`, and values of type `double` can be converted to type `__m128d` for use with these functions using the `_mm_set_sd` function, and converted back using the `_mm_cvtsd_f64` function. When used with functions that operate on packed double-precision floating-point data the scalar element corresponds with the first packed value.
- `_epi8`, which indicates a function that operates on packed 8-bit signed integer values. Packed 8-bit signed integers correspond to an array of `signed char` with 16, 32 or 64 elements. Values of this type can be created from individual elements using `_mm_set_epi8`, `_mm256_set_epi8`, or `_mm512_set_epi8` functions.
- `_epi16`, which indicates a function that operates on packed 16-bit signed integer values. Packed 16-bit signed integers correspond to an array of `short` with 8, 16 or 32 elements. Values of this type can be created from individual elements using `_mm_set_epi16`, `_mm256_set_epi16`, or `_mm512_set_epi16` functions.
- `_epi32`, which indicates a function that operates on packed 32-bit signed integer values. Packed 32-bit signed integers correspond to an array of `int` with 4, 8 or 16 elements. Values of this type can be created from individual elements using `_mm_set_epi32`, `_mm256_set_epi32`, or `_mm512_set_epi32` functions.
- `_epi64`, which indicates a function that operates on packed 64-bit signed integer values. Packed 64-bit signed integers correspond to an array of `long long` (or `long` if it is a 64-bit data type) with 2, 4 or 8 elements. Values of this type can be created from individual elements using `_mm_set_epi32`, `_mm256_set_epi32`, or `_mm512_set_epi32` functions.
- `_epu8`, which indicates a function that operates on packed 8-bit unsigned integer values. Packed 8-bit unsigned integers correspond to an array of `unsigned char` with 16, 32 or 64 elements.

- `_epu16`, which indicates a function that operates on packed 16-bit unsigned integer values. Packed 16-bit unsigned integers correspond to an array of *unsigned short* with 8, 16 or 32 elements.
- `_epu32`, which indicates a function that operates on packed 32-bit unsigned integer values. Packed 32-bit unsigned integers correspond to an array of *unsigned* with 4, 8 or 16 elements.
- `_epu64`, which indicates a function that operates on packed 64-bit unsigned integer values. Packed 64-bit unsigned integers correspond to an array of *unsigned long long* (or *unsigned long* if it is a 64-bit data type) with 2, 4 or 8 elements.
- `_si128`, which indicates a function that operates on a single 128-bit value of type `__m128i`.
- `_si256`, which indicates a function that operates on a single a 256-bit value of type `__m256i`.
- `_si512`, which indicates a function that operates on a single a 512-bit value of type `__m512i`.

Values of any packed integer type can be loaded from an array using the `_mm_loadu_si128`, `_mm256_loadu_si256`, or `_mm512_loadu_si512` functions, and they can be stored in an array using `_mm_storeu_si128`, `_mm256_storeu_si256`, or `_mm512_storeu_si512`.

These functions and data types are used with the SSE, AVX, and AVX-512 instruction set extension families. In addition there are similar functions that correspond to MMX instructions. These are less frequently used because they require additional state management, and only operate on 64-bit packed integer values.

The declarations of Intel C/C++ compiler intrinsic functions may reference some non-standard data types, such as `__int64`. The C Standard header `stdint.h` defines similar platform-independent types, and the documentation for that header gives characteristics that apply to corresponding non-standard types according to the following table.

**Table 3-3. Standard and Non-standard Data Types**

Non-standard Type	Standard Type (from <code>stdint.h</code> )
<code>__int64</code>	<code>int64_t</code>
<code>unsigned __int64</code>	<code>uint64_t</code>
<code>__int32</code>	<code>int32_t</code>
<code>unsigned __int32</code>	<code>uint32_t</code>
<code>__int16</code>	<code>int16_t</code>
<code>unsigned __int16</code>	<code>uint16_t</code>

For a more detailed description of each intrinsic function and additional information related to its usage, refer to the online Intel Intrinsics Guide, <https://software.intel.com/sites/landingpage/IntrinsicsGuide>.

### 3.1.1.11 Flags Affected Section

The “Flags Affected” section lists the flags in the EFLAGS register that are affected by the instruction. When a flag is cleared, it is equal to 0; when it is set, it is equal to 1. The arithmetic and logical instructions usually assign values to the status flags in a uniform manner (see Appendix A, “EFLAGS Cross-Reference,” in the *Intel® 64 and IA-32 Architectures Software Developer’s Manual, Volume 1*). Non-conventional assignments are described in the “Operation” section. The values of flags listed as **undefined** may be changed by the instruction in an indeterminate manner. Flags that are not listed are unchanged by the instruction.

### 3.1.1.12 FPU Flags Affected Section

The floating-point instructions have an “FPU Flags Affected” section that describes how each instruction can affect the four condition code flags of the FPU status word.

### 3.1.1.13 Protected Mode Exceptions Section

The “Protected Mode Exceptions” section lists the exceptions that can occur when the instruction is executed in protected mode and the reasons for the exceptions. Each exception is given a mnemonic that consists of a pound

sign (#) followed by two letters and an optional error code in parentheses. For example, #GP(0) denotes a general protection exception with an error code of 0. Table 3-4 associates each two-letter mnemonic with the corresponding exception vector and name. See Chapter 6, “Procedure Calls, Interrupts, and Exceptions,” in the *Intel® 64 and IA-32 Architectures Software Developer’s Manual, Volume 3A*, for a detailed description of the exceptions.

Application programmers should consult the documentation provided with their operating systems to determine the actions taken when exceptions occur.

**Table 3-4. Intel 64 and IA-32 General Exceptions**

Vector	Name	Source	Protected Mode <sup>7</sup>	Real Address Mode	Virtual 8086 Mode
0	#DE—Divide Error	DIV and IDIV instructions.	Yes	Yes	Yes
1	#DB—Debug	Any code or data reference.	Yes	Yes	Yes
3	#BP—Breakpoint	INT 3 instruction.	Yes	Yes	Yes
4	#OF—Overflow	INTO instruction.	Yes	Yes	Yes
5	#BR—BOUND Range Exceeded	BOUND instruction.	Yes	Yes	Yes
6	#UD—Invalid Opcode (Undefined Opcode)	UD instruction or reserved opcode.	Yes	Yes	Yes
7	#NM—Device Not Available (No Math Coprocessor)	Floating-point or WAIT/FWAIT instruction.	Yes	Yes	Yes
8	#DF—Double Fault	Any instruction that can generate an exception, an NMI, or an INTR.	Yes	Yes	Yes
10	#TS—Invalid TSS	Task switch or TSS access.	Yes	Reserved	Yes
11	#NP—Segment Not Present	Loading segment registers or accessing system segments.	Yes	Reserved	Yes
12	#SS—Stack Segment Fault	Stack operations and SS register loads.	Yes	Yes	Yes
13	#GP—General Protection <sup>2</sup>	Any memory reference and other protection checks.	Yes	Yes	Yes
14	#PF—Page Fault	Any memory reference.	Yes	Reserved	Yes
16	#MF—Floating-Point Error (Math Fault)	Floating-point or WAIT/FWAIT instruction.	Yes	Yes	Yes
17	#AC—Alignment Check	Any data reference in memory.	Yes	Reserved	Yes
18	#MC—Machine Check	Model dependent machine check errors.	Yes	Yes	Yes
19	#XM—SIMD Floating-Point Numeric Error	SSE/SSE2/SSE3 floating-point instructions.	Yes	Yes	Yes

**NOTES:**

1. Apply to protected mode, compatibility mode, and 64-bit mode.
2. In the real-address mode, vector 13 is the segment overrun exception.

### 3.1.1.14 Real-Address Mode Exceptions Section

The “Real-Address Mode Exceptions” section lists the exceptions that can occur when the instruction is executed in real-address mode (see Table 3-4).

### 3.1.1.15 Virtual-8086 Mode Exceptions Section

The “Virtual-8086 Mode Exceptions” section lists the exceptions that can occur when the instruction is executed in virtual-8086 mode (see Table 3-4).

### 3.1.1.16 Floating-Point Exceptions Section

The “Floating-Point Exceptions” section lists exceptions that can occur when an x87 FPU floating-point instruction is executed. All of these exception conditions result in a floating-point error exception (#MF, exception 16) being generated. Table 3-5 associates a one- or two-letter mnemonic with the corresponding exception name. See “Floating-Point Exception Conditions” in Chapter 8 of the *Intel® 64 and IA-32 Architectures Software Developer’s Manual, Volume 1*, for a detailed description of these exceptions.

**Table 3-5. x87 FPU Floating-Point Exceptions**

Mnemonic	Name	Source
#IS #IA	Floating-point invalid operation: - Stack overflow or underflow - Invalid arithmetic operation	- x87 FPU stack overflow or underflow - Invalid FPU arithmetic operation
#Z	Floating-point divide-by-zero	Divide-by-zero
#D	Floating-point denormal operand	Source operand that is a denormal number
#O	Floating-point numeric overflow	Overflow in result
#U	Floating-point numeric underflow	Underflow in result
#P	Floating-point inexact result (precision)	Inexact result (precision)

### 3.1.1.17 SIMD Floating-Point Exceptions Section

The “SIMD Floating-Point Exceptions” section lists exceptions that can occur when an SSE/SSE2/SSE3 floating-point instruction is executed. All of these exception conditions result in a SIMD floating-point error exception (#XM, exception 19) being generated. Table 3-6 associates a one-letter mnemonic with the corresponding exception name. For a detailed description of these exceptions, refer to “SSE and SSE2 Exceptions”, in Chapter 11 of the *Intel® 64 and IA-32 Architectures Software Developer’s Manual, Volume 1*.

**Table 3-6. SIMD Floating-Point Exceptions**

Mnemonic	Name	Source
#I	Floating-point invalid operation	Invalid arithmetic operation or source operand
#Z	Floating-point divide-by-zero	Divide-by-zero
#D	Floating-point denormal operand	Source operand that is a denormal number
#O	Floating-point numeric overflow	Overflow in result
#U	Floating-point numeric underflow	Underflow in result
#P	Floating-point inexact result	Inexact result (precision)

### 3.1.1.18 Compatibility Mode Exceptions Section

This section lists exceptions that occur within compatibility mode.

### 3.1.1.19 64-Bit Mode Exceptions Section

This section lists exceptions that occur within 64-bit mode.

## 3.2 INSTRUCTIONS (A-L)

The remainder of this chapter provides descriptions of Intel 64 and IA-32 instructions (A-L). See also: Chapter 4, “Instruction Set Reference, M-U,” in the *Intel® 64 and IA-32 Architectures Software Developer’s Manual, Volume 2B*, and Chapter 5, “Instruction Set Reference, V-Z,” in the *Intel® 64 and IA-32 Architectures Software Developer’s Manual, Volume 2C*.



## AAA—ASCII Adjust After Addition

Opcode	Instruction	Op/En	64-bit Mode	Compat/Leg Mode	Description
37	AAA	Z0	Invalid	Valid	ASCII adjust AL after addition.

### Instruction Operand Encoding

Op/En	Operand 1	Operand 2	Operand 3	Operand 4
Z0	NA	NA	NA	NA

### Description

Adjusts the sum of two unpacked BCD values to create an unpacked BCD result. The AL register is the implied source and destination operand for this instruction. The AAA instruction is only useful when it follows an ADD instruction that adds (binary addition) two unpacked BCD values and stores a byte result in the AL register. The AAA instruction then adjusts the contents of the AL register to contain the correct 1-digit unpacked BCD result.

If the addition produces a decimal carry, the AH register increments by 1, and the CF and AF flags are set. If there was no decimal carry, the CF and AF flags are cleared and the AH register is unchanged. In either case, bits 4 through 7 of the AL register are set to 0.

This instruction executes as described in compatibility mode and legacy mode. It is not valid in 64-bit mode.

### Operation

```
IF 64-Bit Mode
  THEN
    #UD;
  ELSE
    IF ((AL AND 0FH) > 9) or (AF = 1)
      THEN
        AX ← AX + 106H;
        AF ← 1;
        CF ← 1;
      ELSE
        AF ← 0;
        CF ← 0;
    FI;
    AL ← AL AND 0FH;
```

FI;

### Flags Affected

The AF and CF flags are set to 1 if the adjustment results in a decimal carry; otherwise they are set to 0. The OF, SF, ZF, and PF flags are undefined.

### Protected Mode Exceptions

#UD If the LOCK prefix is used.

### Real-Address Mode Exceptions

Same exceptions as protected mode.

### Virtual-8086 Mode Exceptions

Same exceptions as protected mode.

**Compatibility Mode Exceptions**

Same exceptions as protected mode.

**64-Bit Mode Exceptions**

#UD                      If in 64-bit mode.

## AAD—ASCII Adjust AX Before Division

Opcode	Instruction	Op/En	64-bit Mode	Compat/Leg Mode	Description
D5 0A	AAD	Z0	Invalid	Valid	ASCII adjust AX before division.
D5 <i>ib</i>	AAD <i>imm8</i>	Z0	Invalid	Valid	Adjust AX before division to number base <i>imm8</i> .

### Instruction Operand Encoding

Op/En	Operand 1	Operand 2	Operand 3	Operand 4
Z0	NA	NA	NA	NA

### Description

Adjusts two unpacked BCD digits (the least-significant digit in the AL register and the most-significant digit in the AH register) so that a division operation performed on the result will yield a correct unpacked BCD value. The AAD instruction is only useful when it precedes a DIV instruction that divides (binary division) the adjusted value in the AX register by an unpacked BCD value.

The AAD instruction sets the value in the AL register to  $(AL + (10 * AH))$ , and then clears the AH register to 00H. The value in the AX register is then equal to the binary equivalent of the original unpacked two-digit (base 10) number in registers AH and AL.

The generalized version of this instruction allows adjustment of two unpacked digits of any number base (see the “Operation” section below), by setting the *imm8* byte to the selected number base (for example, 08H for octal, 0AH for decimal, or 0CH for base 12 numbers). The AAD mnemonic is interpreted by all assemblers to mean adjust ASCII (base 10) values. To adjust values in another number base, the instruction must be hand coded in machine code (D5 *imm8*).

This instruction executes as described in compatibility mode and legacy mode. It is not valid in 64-bit mode.

### Operation

```
IF 64-Bit Mode
  THEN
    #UD;
  ELSE
    tempAL ← AL;
    tempAH ← AH;
    AL ← (tempAL + (tempAH * imm8)) AND FFH;
    (* imm8 is set to 0AH for the AAD mnemonic.*)
    AH ← 0;
```

FI;

The immediate value (*imm8*) is taken from the second byte of the instruction.

### Flags Affected

The SF, ZF, and PF flags are set according to the resulting binary value in the AL register; the OF, AF, and CF flags are undefined.

### Protected Mode Exceptions

#UD If the LOCK prefix is used.

### Real-Address Mode Exceptions

Same exceptions as protected mode.

**Virtual-8086 Mode Exceptions**

Same exceptions as protected mode.

**Compatibility Mode Exceptions**

Same exceptions as protected mode.

**64-Bit Mode Exceptions**

#UD                      If in 64-bit mode.

## AAM—ASCII Adjust AX After Multiply

Opcode	Instruction	Op/En	64-bit Mode	Compat/Leg Mode	Description
D4 0A	AAM	Z0	Invalid	Valid	ASCII adjust AX after multiply.
D4 <i>ib</i>	AAM <i>imm8</i>	Z0	Invalid	Valid	Adjust AX after multiply to number base <i>imm8</i> .

### Instruction Operand Encoding

Op/En	Operand 1	Operand 2	Operand 3	Operand 4
Z0	NA	NA	NA	NA

### Description

Adjusts the result of the multiplication of two unpacked BCD values to create a pair of unpacked (base 10) BCD values. The AX register is the implied source and destination operand for this instruction. The AAM instruction is only useful when it follows an MUL instruction that multiplies (binary multiplication) two unpacked BCD values and stores a word result in the AX register. The AAM instruction then adjusts the contents of the AX register to contain the correct 2-digit unpacked (base 10) BCD result.

The generalized version of this instruction allows adjustment of the contents of the AX to create two unpacked digits of any number base (see the “Operation” section below). Here, the *imm8* byte is set to the selected number base (for example, 08H for octal, 0AH for decimal, or 0CH for base 12 numbers). The AAM mnemonic is interpreted by all assemblers to mean adjust to ASCII (base 10) values. To adjust to values in another number base, the instruction must be hand coded in machine code (D4 *imm8*).

This instruction executes as described in compatibility mode and legacy mode. It is not valid in 64-bit mode.

### Operation

```
IF 64-Bit Mode
  THEN
    #UD;
  ELSE
    tempAL ← AL;
    AH ← tempAL / imm8; (* imm8 is set to 0AH for the AAM mnemonic *)
    AL ← tempAL MOD imm8;
FI;
```

The immediate value (*imm8*) is taken from the second byte of the instruction.

### Flags Affected

The SF, ZF, and PF flags are set according to the resulting binary value in the AL register. The OF, AF, and CF flags are undefined.

### Protected Mode Exceptions

#DE If an immediate value of 0 is used.  
 #UD If the LOCK prefix is used.

### Real-Address Mode Exceptions

Same exceptions as protected mode.

### Virtual-8086 Mode Exceptions

Same exceptions as protected mode.

### Compatibility Mode Exceptions

Same exceptions as protected mode.

### 64-Bit Mode Exceptions

#UD                      If in 64-bit mode.

## AAS—ASCII Adjust AL After Subtraction

Opcode	Instruction	Op/En	64-bit Mode	Compat/Leg Mode	Description
3F	AAS	Z0	Invalid	Valid	ASCII adjust AL after subtraction.

### Instruction Operand Encoding

Op/En	Operand 1	Operand 2	Operand 3	Operand 4
Z0	NA	NA	NA	NA

### Description

Adjusts the result of the subtraction of two unpacked BCD values to create a unpacked BCD result. The AL register is the implied source and destination operand for this instruction. The AAS instruction is only useful when it follows a SUB instruction that subtracts (binary subtraction) one unpacked BCD value from another and stores a byte result in the AL register. The AAA instruction then adjusts the contents of the AL register to contain the correct 1-digit unpacked BCD result.

If the subtraction produced a decimal carry, the AH register decrements by 1, and the CF and AF flags are set. If no decimal carry occurred, the CF and AF flags are cleared, and the AH register is unchanged. In either case, the AL register is left with its top four bits set to 0.

This instruction executes as described in compatibility mode and legacy mode. It is not valid in 64-bit mode.

### Operation

```

IF 64-bit mode
  THEN
    #UD;
  ELSE
    IF ((AL AND 0FH) > 9) or (AF = 1)
      THEN
        AX ← AX - 6;
        AH ← AH - 1;
        AF ← 1;
        CF ← 1;
        AL ← AL AND 0FH;
      ELSE
        CF ← 0;
        AF ← 0;
        AL ← AL AND 0FH;
    FI;
  FI;

```

### Flags Affected

The AF and CF flags are set to 1 if there is a decimal borrow; otherwise, they are cleared to 0. The OF, SF, ZF, and PF flags are undefined.

### Protected Mode Exceptions

#UD If the LOCK prefix is used.

### Real-Address Mode Exceptions

Same exceptions as protected mode.

**Virtual-8086 Mode Exceptions**

Same exceptions as protected mode.

**Compatibility Mode Exceptions**

Same exceptions as protected mode.

**64-Bit Mode Exceptions**

#UD                      If in 64-bit mode.



## ADC—Add with Carry

Opcode	Instruction	Op/En	64-bit Mode	Compat/Leg Mode	Description
14 <i>ib</i>	ADC AL, <i>imm8</i>	I	Valid	Valid	Add with carry <i>imm8</i> to AL.
15 <i>iw</i>	ADC AX, <i>imm16</i>	I	Valid	Valid	Add with carry <i>imm16</i> to AX.
15 <i>id</i>	ADC EAX, <i>imm32</i>	I	Valid	Valid	Add with carry <i>imm32</i> to EAX.
REX.W + 15 <i>id</i>	ADC RAX, <i>imm32</i>	I	Valid	N.E.	Add with carry <i>imm32</i> sign extended to 64-bits to RAX.
80 /2 <i>ib</i>	ADC <i>r/m8</i> , <i>imm8</i>	MI	Valid	Valid	Add with carry <i>imm8</i> to <i>r/m8</i> .
REX + 80 /2 <i>ib</i>	ADC <i>r/m8</i> , <i>imm8</i>	MI	Valid	N.E.	Add with carry <i>imm8</i> to <i>r/m8</i> .
81 /2 <i>iw</i>	ADC <i>r/m16</i> , <i>imm16</i>	MI	Valid	Valid	Add with carry <i>imm16</i> to <i>r/m16</i> .
81 /2 <i>id</i>	ADC <i>r/m32</i> , <i>imm32</i>	MI	Valid	Valid	Add with CF <i>imm32</i> to <i>r/m32</i> .
REX.W + 81 /2 <i>id</i>	ADC <i>r/m64</i> , <i>imm32</i>	MI	Valid	N.E.	Add with CF <i>imm32</i> sign extended to 64-bits to <i>r/m64</i> .
83 /2 <i>ib</i>	ADC <i>r/m16</i> , <i>imm8</i>	MI	Valid	Valid	Add with CF sign-extended <i>imm8</i> to <i>r/m16</i> .
83 /2 <i>ib</i>	ADC <i>r/m32</i> , <i>imm8</i>	MI	Valid	Valid	Add with CF sign-extended <i>imm8</i> into <i>r/m32</i> .
REX.W + 83 /2 <i>ib</i>	ADC <i>r/m64</i> , <i>imm8</i>	MI	Valid	N.E.	Add with CF sign-extended <i>imm8</i> into <i>r/m64</i> .
10 / <i>r</i>	ADC <i>r/m8</i> , <i>r8</i>	MR	Valid	Valid	Add with carry byte register to <i>r/m8</i> .
REX + 10 / <i>r</i>	ADC <i>r/m8</i> , <i>r8</i>	MR	Valid	N.E.	Add with carry byte register to <i>r/m64</i> .
11 / <i>r</i>	ADC <i>r/m16</i> , <i>r16</i>	MR	Valid	Valid	Add with carry <i>r16</i> to <i>r/m16</i> .
11 / <i>r</i>	ADC <i>r/m32</i> , <i>r32</i>	MR	Valid	Valid	Add with CF <i>r32</i> to <i>r/m32</i> .
REX.W + 11 / <i>r</i>	ADC <i>r/m64</i> , <i>r64</i>	MR	Valid	N.E.	Add with CF <i>r64</i> to <i>r/m64</i> .
12 / <i>r</i>	ADC <i>r8</i> , <i>r/m8</i>	RM	Valid	Valid	Add with carry <i>r/m8</i> to byte register.
REX + 12 / <i>r</i>	ADC <i>r8</i> , <i>r/m8</i>	RM	Valid	N.E.	Add with carry <i>r/m64</i> to byte register.
13 / <i>r</i>	ADC <i>r16</i> , <i>r/m16</i>	RM	Valid	Valid	Add with carry <i>r/m16</i> to <i>r16</i> .
13 / <i>r</i>	ADC <i>r32</i> , <i>r/m32</i>	RM	Valid	Valid	Add with CF <i>r/m32</i> to <i>r32</i> .
REX.W + 13 / <i>r</i>	ADC <i>r64</i> , <i>r/m64</i>	RM	Valid	N.E.	Add with CF <i>r/m64</i> to <i>r64</i> .

### NOTES:

\*In 64-bit mode, *r/m8* can not be encoded to access the following byte registers if a REX prefix is used: AH, BH, CH, DH.

### Instruction Operand Encoding

Op/En	Operand 1	Operand 2	Operand 3	Operand 4
RM	ModRM:reg ( <i>r</i> , <i>w</i> )	ModRM:r/m ( <i>r</i> )	NA	NA
MR	ModRM:r/m ( <i>r</i> , <i>w</i> )	ModRM:reg ( <i>r</i> )	NA	NA
MI	ModRM:r/m ( <i>r</i> , <i>w</i> )	<i>imm8/16/32</i>	NA	NA
I	AL/AX/EAX/RAX	<i>imm8/16/32</i>	NA	NA

### Description

Adds the destination operand (first operand), the source operand (second operand), and the carry (CF) flag and stores the result in the destination operand. The destination operand can be a register or a memory location; the source operand can be an immediate, a register, or a memory location. (However, two memory operands cannot be used in one instruction.) The state of the CF flag represents a carry from a previous addition. When an immediate value is used as an operand, it is sign-extended to the length of the destination operand format.

The ADC instruction does not distinguish between signed or unsigned operands. Instead, the processor evaluates the result for both data types and sets the OF and CF flags to indicate a carry in the signed or unsigned result, respectively. The SF flag indicates the sign of the signed result.

The ADC instruction is usually executed as part of a multibyte or multiword addition in which an ADD instruction is followed by an ADC instruction.

This instruction can be used with a LOCK prefix to allow the instruction to be executed atomically.

In 64-bit mode, the instruction's default operation size is 32 bits. Using a REX prefix in the form of REX.R permits access to additional registers (R8-R15). Using a REX prefix in the form of REX.W promotes operation to 64 bits. See the summary chart at the beginning of this section for encoding data and limits.

## Operation

$DEST \leftarrow DEST + SRC + CF;$

## Intel C/C++ Compiler Intrinsic Equivalent

ADC: extern unsigned char \_addcarry\_u8(unsigned char c\_in, unsigned char src1, unsigned char src2, unsigned char \*sum\_out);

ADC: extern unsigned char \_addcarry\_u16(unsigned char c\_in, unsigned short src1, unsigned short src2, unsigned short \*sum\_out);

ADC: extern unsigned char \_addcarry\_u32(unsigned char c\_in, unsigned int src1, unsigned char int, unsigned int \*sum\_out);

ADC: extern unsigned char \_addcarry\_u64(unsigned char c\_in, unsigned \_\_int64 src1, unsigned \_\_int64 src2, unsigned \_\_int64 \*sum\_out);

## Flags Affected

The OF, SF, ZF, AF, CF, and PF flags are set according to the result.

## Protected Mode Exceptions

#GP(0)	If the destination is located in a non-writable segment. If a memory operand effective address is outside the CS, DS, ES, FS, or GS segment limit. If the DS, ES, FS, or GS register is used to access memory and it contains a NULL segment selector.
#SS(0)	If a memory operand effective address is outside the SS segment limit.
#PF(fault-code)	If a page fault occurs.
#AC(0)	If alignment checking is enabled and an unaligned memory reference is made while the current privilege level is 3.
#UD	If the LOCK prefix is used but the destination is not a memory operand.

## Real-Address Mode Exceptions

#GP	If a memory operand effective address is outside the CS, DS, ES, FS, or GS segment limit.
#SS	If a memory operand effective address is outside the SS segment limit.
#UD	If the LOCK prefix is used but the destination is not a memory operand.

## Virtual-8086 Mode Exceptions

#GP(0)	If a memory operand effective address is outside the CS, DS, ES, FS, or GS segment limit.
#SS(0)	If a memory operand effective address is outside the SS segment limit.
#PF(fault-code)	If a page fault occurs.
#AC(0)	If alignment checking is enabled and an unaligned memory reference is made.
#UD	If the LOCK prefix is used but the destination is not a memory operand.

### Compatibility Mode Exceptions

Same exceptions as in protected mode.

### 64-Bit Mode Exceptions

#SS(0)	If a memory address referencing the SS segment is in a non-canonical form.
#GP(0)	If the memory address is in a non-canonical form.
#PF(fault-code)	If a page fault occurs.
#AC(0)	If alignment checking is enabled and an unaligned memory reference is made while the current privilege level is 3.
#UD	If the LOCK prefix is used but the destination is not a memory operand.

## ADCX – Unsigned Integer Addition of Two Operands with Carry Flag

Opcode/ Instruction	Op/ En	64/32bit Mode Support	CPUID Feature Flag	Description
66 0F 38 F6 /r ADCX r32, r/m32	RM	V/V	ADX	Unsigned addition of r32 with CF, r/m32 to r32, writes CF.
66 REX.w 0F 38 F6 /r ADCX r64, r/m64	RM	V/NE	ADX	Unsigned addition of r64 with CF, r/m64 to r64, writes CF.

### Instruction Operand Encoding

Op/En	Operand 1	Operand 2	Operand 3	Operand 4
RM	ModRM:reg (r, w)	ModRM:r/m (r)	NA	NA

### Description

Performs an unsigned addition of the destination operand (first operand), the source operand (second operand) and the carry-flag (CF) and stores the result in the destination operand. The destination operand is a general-purpose register, whereas the source operand can be a general-purpose register or memory location. The state of CF can represent a carry from a previous addition. The instruction sets the CF flag with the carry generated by the unsigned addition of the operands.

The ADCX instruction is executed in the context of multi-precision addition, where we add a series of operands with a carry-chain. At the beginning of a chain of additions, we need to make sure the CF is in a desired initial state. Often, this initial state needs to be 0, which can be achieved with an instruction to zero the CF (e.g. XOR).

This instruction is supported in real mode and virtual-8086 mode. The operand size is always 32 bits if not in 64-bit mode.

In 64-bit mode, the default operation size is 32 bits. Using a REX Prefix in the form of REX.R permits access to additional registers (R8-15). Using REX Prefix in the form of REX.W promotes operation to 64 bits.

ADCX executes normally either inside or outside a transaction region.

Note: ADCX defines the OF flag differently than the ADD/ADC instructions as defined in *Intel® 64 and IA-32 Architectures Software Developer's Manual, Volume 2A*.

### Operation

IF OperandSize is 64-bit

THEN CF:DEST[63:0] ← DEST[63:0] + SRC[63:0] + CF;

ELSE CF:DEST[31:0] ← DEST[31:0] + SRC[31:0] + CF;

FI;

### Flags Affected

CF is updated based on result. OF, SF, ZF, AF and PF flags are unmodified.

### Intel C/C++ Compiler Intrinsic Equivalent

unsigned char \_addcarryx\_u32 (unsigned char c\_in, unsigned int src1, unsigned int src2, unsigned int \*sum\_out);

unsigned char \_addcarryx\_u64 (unsigned char c\_in, unsigned \_\_int64 src1, unsigned \_\_int64 src2, unsigned \_\_int64 \*sum\_out);

### SIMD Floating-Point Exceptions

None

### Protected Mode Exceptions

#UD If the LOCK prefix is used.

If CPUID.(EAX=07H, ECX=0H):EBX.ADX[bit 19] = 0.

#SS(0) For an illegal address in the SS segment.

#GP(0)	For an illegal memory operand effective address in the CS, DS, ES, FS or GS segments. If the DS, ES, FS, or GS register is used to access memory and it contains a null segment selector.
#PF(fault-code)	For a page fault.
#AC(0)	If alignment checking is enabled and an unaligned memory reference is made while the current privilege level is 3.

### Real-Address Mode Exceptions

#UD	If the LOCK prefix is used. If CPUID.(EAX=07H, ECX=0H):EBX.ADX[bit 19] = 0.
#SS(0)	For an illegal address in the SS segment.
#GP(0)	If any part of the operand lies outside the effective address space from 0 to FFFFH.

### Virtual-8086 Mode Exceptions

#UD	If the LOCK prefix is used. If CPUID.(EAX=07H, ECX=0H):EBX.ADX[bit 19] = 0.
#SS(0)	For an illegal address in the SS segment.
#GP(0)	If any part of the operand lies outside the effective address space from 0 to FFFFH.
#PF(fault-code)	For a page fault.
#AC(0)	If alignment checking is enabled and an unaligned memory reference is made while the current privilege level is 3.

### Compatibility Mode Exceptions

Same exceptions as in protected mode.

### 64-Bit Mode Exceptions

#UD	If the LOCK prefix is used. If CPUID.(EAX=07H, ECX=0H):EBX.ADX[bit 19] = 0.
#SS(0)	If a memory address referencing the SS segment is in a non-canonical form.
#GP(0)	If the memory address is in a non-canonical form.
#PF(fault-code)	For a page fault.
#AC(0)	If alignment checking is enabled and an unaligned memory reference is made while the current privilege level is 3.

**ADD—Add**

Opcode	Instruction	Op/En	64-bit Mode	Compat/Leg Mode	Description
04 <i>ib</i>	ADD AL, <i>imm8</i>	I	Valid	Valid	Add <i>imm8</i> to AL.
05 <i>iw</i>	ADD AX, <i>imm16</i>	I	Valid	Valid	Add <i>imm16</i> to AX.
05 <i>id</i>	ADD EAX, <i>imm32</i>	I	Valid	Valid	Add <i>imm32</i> to EAX.
REX.W + 05 <i>id</i>	ADD RAX, <i>imm32</i>	I	Valid	N.E.	Add <i>imm32 sign-extended to 64-bits</i> to RAX.
80 /0 <i>ib</i>	ADD <i>r/m8</i> , <i>imm8</i>	MI	Valid	Valid	Add <i>imm8</i> to <i>r/m8</i> .
REX + 80 /0 <i>ib</i>	ADD <i>r/m8</i> <sup>*</sup> , <i>imm8</i>	MI	Valid	N.E.	Add <i>sign-extended imm8</i> to <i>r/m8</i> .
81 /0 <i>iw</i>	ADD <i>r/m16</i> , <i>imm16</i>	MI	Valid	Valid	Add <i>imm16</i> to <i>r/m16</i> .
81 /0 <i>id</i>	ADD <i>r/m32</i> , <i>imm32</i>	MI	Valid	Valid	Add <i>imm32</i> to <i>r/m32</i> .
REX.W + 81 /0 <i>id</i>	ADD <i>r/m64</i> , <i>imm32</i>	MI	Valid	N.E.	Add <i>imm32 sign-extended to 64-bits</i> to <i>r/m64</i> .
83 /0 <i>ib</i>	ADD <i>r/m16</i> , <i>imm8</i>	MI	Valid	Valid	Add <i>sign-extended imm8</i> to <i>r/m16</i> .
83 /0 <i>ib</i>	ADD <i>r/m32</i> , <i>imm8</i>	MI	Valid	Valid	Add <i>sign-extended imm8</i> to <i>r/m32</i> .
REX.W + 83 /0 <i>ib</i>	ADD <i>r/m64</i> , <i>imm8</i>	MI	Valid	N.E.	Add <i>sign-extended imm8</i> to <i>r/m64</i> .
00 / <i>r</i>	ADD <i>r/m8</i> , <i>r8</i>	MR	Valid	Valid	Add <i>r8</i> to <i>r/m8</i> .
REX + 00 / <i>r</i>	ADD <i>r/m8</i> <sup>*</sup> , <i>r8</i> <sup>*</sup>	MR	Valid	N.E.	Add <i>r8</i> to <i>r/m8</i> .
01 / <i>r</i>	ADD <i>r/m16</i> , <i>r16</i>	MR	Valid	Valid	Add <i>r16</i> to <i>r/m16</i> .
01 / <i>r</i>	ADD <i>r/m32</i> , <i>r32</i>	MR	Valid	Valid	Add <i>r32</i> to <i>r/m32</i> .
REX.W + 01 / <i>r</i>	ADD <i>r/m64</i> , <i>r64</i>	MR	Valid	N.E.	Add <i>r64</i> to <i>r/m64</i> .
02 / <i>r</i>	ADD <i>r8</i> , <i>r/m8</i>	RM	Valid	Valid	Add <i>r/m8</i> to <i>r8</i> .
REX + 02 / <i>r</i>	ADD <i>r8</i> <sup>*</sup> , <i>r/m8</i> <sup>*</sup>	RM	Valid	N.E.	Add <i>r/m8</i> to <i>r8</i> .
03 / <i>r</i>	ADD <i>r16</i> , <i>r/m16</i>	RM	Valid	Valid	Add <i>r/m16</i> to <i>r16</i> .
03 / <i>r</i>	ADD <i>r32</i> , <i>r/m32</i>	RM	Valid	Valid	Add <i>r/m32</i> to <i>r32</i> .
REX.W + 03 / <i>r</i>	ADD <i>r64</i> , <i>r/m64</i>	RM	Valid	N.E.	Add <i>r/m64</i> to <i>r64</i> .

**NOTES:**

\*In 64-bit mode, *r/m8* can not be encoded to access the following byte registers if a REX prefix is used: AH, BH, CH, DH.

**Instruction Operand Encoding**

Op/En	Operand 1	Operand 2	Operand 3	Operand 4
RM	ModRM:reg ( <i>r</i> , <i>w</i> )	ModRM:r/m ( <i>r</i> )	NA	NA
MR	ModRM:r/m ( <i>r</i> , <i>w</i> )	ModRM:reg ( <i>r</i> )	NA	NA
MI	ModRM:r/m ( <i>r</i> , <i>w</i> )	<i>imm8/16/32</i>	NA	NA
I	AL/AX/EAX/RAX	<i>imm8/16/32</i>	NA	NA

**Description**

Adds the destination operand (first operand) and the source operand (second operand) and then stores the result in the destination operand. The destination operand can be a register or a memory location; the source operand can be an immediate, a register, or a memory location. (However, two memory operands cannot be used in one instruction.) When an immediate value is used as an operand, it is sign-extended to the length of the destination operand format.

The ADD instruction performs integer addition. It evaluates the result for both signed and unsigned integer operands and sets the CF and OF flags to indicate a carry (overflow) in the signed or unsigned result, respectively. The SF flag indicates the sign of the signed result.

This instruction can be used with a LOCK prefix to allow the instruction to be executed atomically.

In 64-bit mode, the instruction's default operation size is 32 bits. Using a REX prefix in the form of REX.R permits access to additional registers (R8-R15). Using a REX prefix in the form of REX.W promotes operation to 64 bits. See the summary chart at the beginning of this section for encoding data and limits.

## Operation

DEST ← DEST + SRC;

## Flags Affected

The OF, SF, ZF, AF, CF, and PF flags are set according to the result.

## Protected Mode Exceptions

#GP(0)	If the destination is located in a non-writable segment. If a memory operand effective address is outside the CS, DS, ES, FS, or GS segment limit. If the DS, ES, FS, or GS register is used to access memory and it contains a NULL segment selector.
#SS(0)	If a memory operand effective address is outside the SS segment limit.
#PF(fault-code)	If a page fault occurs.
#AC(0)	If alignment checking is enabled and an unaligned memory reference is made while the current privilege level is 3.
#UD	If the LOCK prefix is used but the destination is not a memory operand.

## Real-Address Mode Exceptions

#GP	If a memory operand effective address is outside the CS, DS, ES, FS, or GS segment limit.
#SS	If a memory operand effective address is outside the SS segment limit.
#UD	If the LOCK prefix is used but the destination is not a memory operand.

## Virtual-8086 Mode Exceptions

#GP(0)	If a memory operand effective address is outside the CS, DS, ES, FS, or GS segment limit.
#SS(0)	If a memory operand effective address is outside the SS segment limit.
#PF(fault-code)	If a page fault occurs.
#AC(0)	If alignment checking is enabled and an unaligned memory reference is made.
#UD	If the LOCK prefix is used but the destination is not a memory operand.

## Compatibility Mode Exceptions

Same exceptions as in protected mode.

## 64-Bit Mode Exceptions

#SS(0)	If a memory address referencing the SS segment is in a non-canonical form.
#GP(0)	If the memory address is in a non-canonical form.
#PF(fault-code)	If a page fault occurs.
#AC(0)	If alignment checking is enabled and an unaligned memory reference is made while the current privilege level is 3.
#UD	If the LOCK prefix is used but the destination is not a memory operand.

## ADDPD—Add Packed Double-Precision Floating-Point Values

Opcode/ Instruction	Op / En	64/32 bit Mode Support	CPUID Feature Flag	Description
66 0F 58 /r ADDPD xmm1, xmm2/m128	A	V/V	SSE2	Add packed double-precision floating-point values from xmm2/mem to xmm1 and store result in xmm1.
VEX.NDS.128.66.0F.WIG 58 /r VADDPD xmm1,xmm2, xmm3/m128	B	V/V	AVX	Add packed double-precision floating-point values from xmm3/mem to xmm2 and store result in xmm1.
VEX.NDS.256.66.0F.WIG 58 /r VADDPD ymm1, ymm2, ymm3/m256	B	V/V	AVX	Add packed double-precision floating-point values from ymm3/mem to ymm2 and store result in ymm1.
EVEX.NDS.128.66.0F.W1 58 /r VADDPD xmm1 {k1}{z}, xmm2, xmm3/m128/m64bcst	C	V/V	AVX512VL AVX512F	Add packed double-precision floating-point values from xmm3/m128/m64bcst to xmm2 and store result in xmm1 with writemask k1.
EVEX.NDS.256.66.0F.W1 58 /r VADDPD ymm1 {k1}{z}, ymm2, ymm3/m256/m64bcst	C	V/V	AVX512VL AVX512F	Add packed double-precision floating-point values from ymm3/m256/m64bcst to ymm2 and store result in ymm1 with writemask k1.
EVEX.NDS.512.66.0F.W1 58 /r VADDPD zmm1 {k1}{z}, zmm2, zmm3/m512/m64bcst{er}	C	V/V	AVX512F	Add packed double-precision floating-point values from zmm3/m512/m64bcst to zmm2 and store result in zmm1 with writemask k1.

### Instruction Operand Encoding

Op/En	Tuple Type	Operand 1	Operand 2	Operand 3	Operand 4
A	NA	ModRM:reg (r, w)	ModRM:r/m (r)	NA	NA
B	NA	ModRM:reg (w)	VEX.vvvv	ModRM:r/m (r)	NA
C	Full	ModRM:reg (w)	EVEX.vvvv	ModRM:r/m (r)	NA

### Description

Add two, four or eight packed double-precision floating-point values from the first source operand to the second source operand, and stores the packed double-precision floating-point results in the destination operand.

EVEX encoded versions: The first source operand is a ZMM/YMM/XMM register. The second source operand can be a ZMM/YMM/XMM register, a 512/256/128-bit memory location or a 512/256/128-bit vector broadcasted from a 64-bit memory location. The destination operand is a ZMM/YMM/XMM register conditionally updated with writemask k1.

VEX.256 encoded version: The first source operand is a YMM register. The second source operand can be a YMM register or a 256-bit memory location. The destination operand is a YMM register. The upper bits (MAXVL-1:256) of the corresponding ZMM register destination are zeroed.

VEX.128 encoded version: the first source operand is a XMM register. The second source operand is an XMM register or 128-bit memory location. The destination operand is an XMM register. The upper bits (MAXVL-1:128) of the corresponding ZMM register destination are zeroed.

128-bit Legacy SSE version: The second source can be an XMM register or an 128-bit memory location. The destination is not distinct from the first source XMM register and the upper Bits (MAXVL-1:128) of the corresponding ZMM register destination are unmodified.



**Operation****VADDPD (EVEX encoded versions) when src2 operand is a vector register**

(KL, VL) = (2, 128), (4, 256), (8, 512)

IF (VL = 512) AND (EVEX.b = 1)

```

    THEN
        SET_RM(EVEX.RC);
    ELSE
        SET_RM(MXCSR.RM);
FI;
FOR j ← 0 TO KL-1
    i ← j * 64
    IF k1[j] OR *no writemask*
        THEN DEST[i+63:i] ← SRC1[i+63:i] + SRC2[i+63:i]
        ELSE
            IF *merging-masking* ; merging-masking
                THEN *DEST[i+63:i] remains unchanged*
            ELSE ; zeroing-masking
                DEST[i+63:i] ← 0
            FI
        FI
FI;
ENDFOR
DEST[MAXVL-1:VL] ← 0

```

**VADDPD (EVEX encoded versions) when src2 operand is a memory source**

(KL, VL) = (2, 128), (4, 256), (8, 512)

```

FOR j ← 0 TO KL-1
    i ← j * 64
    IF k1[j] OR *no writemask*
        THEN
            IF (EVEX.b = 1)
                THEN
                    DEST[i+63:i] ← SRC1[i+63:i] + SRC2[63:0]
                ELSE
                    DEST[i+63:i] ← SRC1[i+63:i] + SRC2[i+63:i]
            FI;
        ELSE
            IF *merging-masking* ; merging-masking
                THEN *DEST[i+63:i] remains unchanged*
            ELSE ; zeroing-masking
                DEST[i+63:i] ← 0
            FI
        FI
FI;
ENDFOR
DEST[MAXVL-1:VL] ← 0

```

**VADDPD (VEX.256 encoded version)**

DEST[63:0] ← SRC1[63:0] + SRC2[63:0]

DEST[127:64] ← SRC1[127:64] + SRC2[127:64]

DEST[191:128] ← SRC1[191:128] + SRC2[191:128]

DEST[255:192] ← SRC1[255:192] + SRC2[255:192]

DEST[MAXVL-1:256] ← 0

.

**VADDPD (VEX.128 encoded version)**

DEST[63:0] ← SRC1[63:0] + SRC2[63:0]  
 DEST[127:64] ← SRC1[127:64] + SRC2[127:64]  
 DEST[MAXVL-1:128] ← 0

**ADDPD (128-bit Legacy SSE version)**

DEST[63:0] ← DEST[63:0] + SRC[63:0]  
 DEST[127:64] ← DEST[127:64] + SRC[127:64]  
 DEST[MAXVL-1:128] (Unmodified)

**Intel C/C++ Compiler Intrinsic Equivalent**

VADDPD \_\_m512d \_\_mm512\_add\_pd (\_\_m512d a, \_\_m512d b);  
 VADDPD \_\_m512d \_\_mm512\_mask\_add\_pd (\_\_m512d s, \_\_mmask8 k, \_\_m512d a, \_\_m512d b);  
 VADDPD \_\_m512d \_\_mm512\_maskz\_add\_pd (\_\_mmask8 k, \_\_m512d a, \_\_m512d b);  
 VADDPD \_\_m256d \_\_mm256\_mask\_add\_pd (\_\_m256d s, \_\_mmask8 k, \_\_m256d a, \_\_m256d b);  
 VADDPD \_\_m256d \_\_mm256\_maskz\_add\_pd (\_\_mmask8 k, \_\_m256d a, \_\_m256d b);  
 VADDPD \_\_m128d \_\_mm\_mask\_add\_pd (\_\_m128d s, \_\_mmask8 k, \_\_m128d a, \_\_m128d b);  
 VADDPD \_\_m128d \_\_mm\_maskz\_add\_pd (\_\_mmask8 k, \_\_m128d a, \_\_m128d b);  
 VADDPD \_\_m512d \_\_mm512\_add\_round\_pd (\_\_m512d a, \_\_m512d b, int);  
 VADDPD \_\_m512d \_\_mm512\_mask\_add\_round\_pd (\_\_m512d s, \_\_mmask8 k, \_\_m512d a, \_\_m512d b, int);  
 VADDPD \_\_m512d \_\_mm512\_maskz\_add\_round\_pd (\_\_mmask8 k, \_\_m512d a, \_\_m512d b, int);  
 ADDPD \_\_m256d \_\_mm256\_add\_pd (\_\_m256d a, \_\_m256d b);  
 ADDPD \_\_m128d \_\_mm\_add\_pd (\_\_m128d a, \_\_m128d b);

**SIMD Floating-Point Exceptions**

Overflow, Underflow, Invalid, Precision, Denormal

**Other Exceptions**

VEX-encoded instruction, see Exceptions Type 2.

EVEX-encoded instruction, see Exceptions Type E2.

## ADDPS—Add Packed Single-Precision Floating-Point Values

Opcode/ Instruction	Op / En	64/32 bit Mode Support	CPUID Feature Flag	Description
NP 0F 58 /r ADDPS xmm1, xmm2/m128	A	V/V	SSE	Add packed single-precision floating-point values from xmm2/m128 to xmm1 and store result in xmm1.
VEX.NDS.128.0F.WIG 58 /r VADDPS xmm1, xmm2, xmm3/m128	B	V/V	AVX	Add packed single-precision floating-point values from xmm3/m128 to xmm2 and store result in xmm1.
VEX.NDS.256.0F.WIG 58 /r VADDPS ymm1, ymm2, ymm3/m256	B	V/V	AVX	Add packed single-precision floating-point values from ymm3/m256 to ymm2 and store result in ymm1.
EVEX.NDS.128.0F.W0 58 /r VADDPS xmm1 {k1}{z}, xmm2, xmm3/m128/m32bcst	C	V/V	AVX512VL AVX512F	Add packed single-precision floating-point values from xmm3/m128/m32bcst to xmm2 and store result in xmm1 with writemask k1.
EVEX.NDS.256.0F.W0 58 /r VADDPS ymm1 {k1}{z}, ymm2, ymm3/m256/m32bcst	C	V/V	AVX512VL AVX512F	Add packed single-precision floating-point values from ymm3/m256/m32bcst to ymm2 and store result in ymm1 with writemask k1.
EVEX.NDS.512.0F.W0 58 /r VADDPS zmm1 {k1}{z}, zmm2, zmm3/m512/m32bcst {er}	C	V/V	AVX512F	Add packed single-precision floating-point values from zmm3/m512/m32bcst to zmm2 and store result in zmm1 with writemask k1.

### Instruction Operand Encoding

Op/En	Tuple Type	Operand 1	Operand 2	Operand 3	Operand 4
A	NA	ModRM:reg (r, w)	ModRM:r/m (r)	NA	NA
B	NA	ModRM:reg (w)	VEX.vvvv	ModRM:r/m (r)	NA
C	Full	ModRM:reg (w)	EVEX.vvvv	ModRM:r/m (r)	NA

### Description

Add four, eight or sixteen packed single-precision floating-point values from the first source operand with the second source operand, and stores the packed single-precision floating-point results in the destination operand.

EVEX encoded versions: The first source operand is a ZMM/YMM/XMM register. The second source operand can be a ZMM/YMM/XMM register, a 512/256/128-bit memory location or a 512/256/128-bit vector broadcasted from a 32-bit memory location. The destination operand is a ZMM/YMM/XMM register conditionally updated with writemask k1.

VEX.256 encoded version: The first source operand is a YMM register. The second source operand can be a YMM register or a 256-bit memory location. The destination operand is a YMM register. The upper bits (MAXVL-1:256) of the corresponding ZMM register destination are zeroed.

VEX.128 encoded version: the first source operand is a XMM register. The second source operand is an XMM register or 128-bit memory location. The destination operand is an XMM register. The upper bits (MAXVL-1:128) of the corresponding ZMM register destination are zeroed.

128-bit Legacy SSE version: The second source can be an XMM register or an 128-bit memory location. The destination is not distinct from the first source XMM register and the upper Bits (MAXVL-1:128) of the corresponding ZMM register destination are unmodified.

**Operation****VADDPS (EVEX encoded versions) when src2 operand is a register**

(KL, VL) = (4, 128), (8, 256), (16, 512)

IF (VL = 512) AND (EVEX.b = 1)

THEN

SET\_RM(EVEX.RC);

ELSE

SET\_RM(MXCSR.RM);

FI;

FOR j ← 0 TO KL-1

i ← j \* 32

IF k1[j] OR \*no writemask\*

THEN DEST[i+31:i] ← SRC1[i+31:i] + SRC2[i+31:i]

ELSE

IF \*merging-masking\* ; merging-masking

THEN \*DEST[i+31:i] remains unchanged\*

ELSE ; zeroing-masking

DEST[i+31:i] ← 0

FI

FI;

ENDFOR;

DEST[MAXVL-1:VL] ← 0

**VADDPS (EVEX encoded versions) when src2 operand is a memory source**

(KL, VL) = (4, 128), (8, 256), (16, 512)

FOR j ← 0 TO KL-1

i ← j \* 32

IF k1[j] OR \*no writemask\*

THEN

IF (EVEX.b = 1)

THEN

DEST[i+31:i] ← SRC1[i+31:i] + SRC2[31:0]

ELSE

DEST[i+31:i] ← SRC1[i+31:i] + SRC2[i+31:i]

FI;

ELSE

IF \*merging-masking\* ; merging-masking

THEN \*DEST[i+31:i] remains unchanged\*

ELSE ; zeroing-masking

DEST[i+31:i] ← 0

FI

FI;

ENDFOR;

DEST[MAXVL-1:VL] ← 0

**VADDPS (VEX.256 encoded version)**

$\text{DEST}[31:0] \leftarrow \text{SRC1}[31:0] + \text{SRC2}[31:0]$   
 $\text{DEST}[63:32] \leftarrow \text{SRC1}[63:32] + \text{SRC2}[63:32]$   
 $\text{DEST}[95:64] \leftarrow \text{SRC1}[95:64] + \text{SRC2}[95:64]$   
 $\text{DEST}[127:96] \leftarrow \text{SRC1}[127:96] + \text{SRC2}[127:96]$   
 $\text{DEST}[159:128] \leftarrow \text{SRC1}[159:128] + \text{SRC2}[159:128]$   
 $\text{DEST}[191:160] \leftarrow \text{SRC1}[191:160] + \text{SRC2}[191:160]$   
 $\text{DEST}[223:192] \leftarrow \text{SRC1}[223:192] + \text{SRC2}[223:192]$   
 $\text{DEST}[255:224] \leftarrow \text{SRC1}[255:224] + \text{SRC2}[255:224]$   
 $\text{DEST}[\text{MAXVL}-1:256] \leftarrow 0$

**VADDPS (VEX.128 encoded version)**

$\text{DEST}[31:0] \leftarrow \text{SRC1}[31:0] + \text{SRC2}[31:0]$   
 $\text{DEST}[63:32] \leftarrow \text{SRC1}[63:32] + \text{SRC2}[63:32]$   
 $\text{DEST}[95:64] \leftarrow \text{SRC1}[95:64] + \text{SRC2}[95:64]$   
 $\text{DEST}[127:96] \leftarrow \text{SRC1}[127:96] + \text{SRC2}[127:96]$   
 $\text{DEST}[\text{MAXVL}-1:128] \leftarrow 0$

**ADDPS (128-bit Legacy SSE version)**

$\text{DEST}[31:0] \leftarrow \text{SRC1}[31:0] + \text{SRC2}[31:0]$   
 $\text{DEST}[63:32] \leftarrow \text{SRC1}[63:32] + \text{SRC2}[63:32]$   
 $\text{DEST}[95:64] \leftarrow \text{SRC1}[95:64] + \text{SRC2}[95:64]$   
 $\text{DEST}[127:96] \leftarrow \text{SRC1}[127:96] + \text{SRC2}[127:96]$   
 $\text{DEST}[\text{MAXVL}-1:128]$  (Unmodified)

**Intel C/C++ Compiler Intrinsic Equivalent**

VADDPS \_\_m512 \_\_mm512\_add\_ps (\_\_m512 a, \_\_m512 b);  
VADDPS \_\_m512 \_\_mm512\_mask\_add\_ps (\_\_m512 s, \_\_mmask16 k, \_\_m512 a, \_\_m512 b);  
VADDPS \_\_m512 \_\_mm512\_maskz\_add\_ps (\_\_mmask16 k, \_\_m512 a, \_\_m512 b);  
VADDPS \_\_m256 \_\_mm256\_mask\_add\_ps (\_\_m256 s, \_\_mmask8 k, \_\_m256 a, \_\_m256 b);  
VADDPS \_\_m256 \_\_mm256\_maskz\_add\_ps (\_\_mmask8 k, \_\_m256 a, \_\_m256 b);  
VADDPS \_\_m128 \_\_mm\_mask\_add\_ps (\_\_m128d s, \_\_mmask8 k, \_\_m128 a, \_\_m128 b);  
VADDPS \_\_m128 \_\_mm\_maskz\_add\_ps (\_\_mmask8 k, \_\_m128 a, \_\_m128 b);  
VADDPS \_\_m512 \_\_mm512\_add\_round\_ps (\_\_m512 a, \_\_m512 b, int);  
VADDPS \_\_m512 \_\_mm512\_mask\_add\_round\_ps (\_\_m512 s, \_\_mmask16 k, \_\_m512 a, \_\_m512 b, int);  
VADDPS \_\_m512 \_\_mm512\_maskz\_add\_round\_ps (\_\_mmask16 k, \_\_m512 a, \_\_m512 b, int);  
ADDPS \_\_m256 \_\_mm256\_add\_ps (\_\_m256 a, \_\_m256 b);  
ADDPS \_\_m128 \_\_mm\_add\_ps (\_\_m128 a, \_\_m128 b);

**SIMD Floating-Point Exceptions**

Overflow, Underflow, Invalid, Precision, Denormal

**Other Exceptions**

VEX-encoded instruction, see Exceptions Type 2.

EVEX-encoded instruction, see Exceptions Type E2.

**ADDSD—Add Scalar Double-Precision Floating-Point Values**

Opcode/ Instruction	Op / En	64/32 bit Mode Support	CPUID Feature Flag	Description
F2 0F 58 /r ADDSD xmm1, xmm2/m64	A	V/V	SSE2	Add the low double-precision floating-point value from xmm2/mem to xmm1 and store the result in xmm1.
VEX.NDS.LIG.F2.0F.WIG 58 /r VADDSD xmm1, xmm2, xmm3/m64	B	V/V	AVX	Add the low double-precision floating-point value from xmm3/mem to xmm2 and store the result in xmm1.
EVEX.NDS.LIG.F2.0F.W1 58 /r VADDSD xmm1 {k1}{z}, xmm2, xmm3/m64{er}	C	V/V	AVX512F	Add the low double-precision floating-point value from xmm3/m64 to xmm2 and store the result in xmm1 with writemask k1.

**Instruction Operand Encoding**

Op/En	Tuple Type	Operand 1	Operand 2	Operand 3	Operand 4
A	NA	ModRM:reg (r, w)	ModRM:r/m (r)	NA	NA
B	NA	ModRM:reg (w)	VEX.vvvv	ModRM:r/m (r)	NA
C	Tuple1 Scalar	ModRM:reg (w)	EVEX.vvvv	ModRM:r/m (r)	NA

**Description**

Adds the low double-precision floating-point values from the second source operand and the first source operand and stores the double-precision floating-point result in the destination operand.

The second source operand can be an XMM register or a 64-bit memory location. The first source and destination operands are XMM registers.

128-bit Legacy SSE version: The first source and destination operands are the same. Bits (MAXVL-1:64) of the corresponding destination register remain unchanged.

EVEX and VEX.128 encoded version: The first source operand is encoded by EVEX.vvvv/VEX.vvvv. Bits (127:64) of the XMM register destination are copied from corresponding bits in the first source operand. Bits (MAXVL-1:128) of the destination register are zeroed.

EVEX version: The low quadword element of the destination is updated according to the writemask.

Software should ensure VADDSD is encoded with VEX.L=0. Encoding VADDSD with VEX.L=1 may encounter unpredictable behavior across different processor generations.

## Operation

### VADDSD (EVEX encoded version)

```

IF (EVEX.b = 1) AND SRC2 *is a register*
    THEN
        SET_RM(EVEX.RC);
    ELSE
        SET_RM(MXCSR.RM);
FI;
IF k1[0] or *no writemask*
    THEN DEST[63:0] ← SRC1[63:0] + SRC2[63:0]
    ELSE
        IF *merging-masking* ; merging-masking
            THEN *DEST[63:0] remains unchanged*
            ELSE ; zeroing-masking
                THEN DEST[63:0] ← 0
        FI;
FI;
DEST[127:64] ← SRC1[127:64]
DEST[MAXVL-1:128] ← 0

```

### VADDSD (VEX.128 encoded version)

```

DEST[63:0] ← SRC1[63:0] + SRC2[63:0]
DEST[127:64] ← SRC1[127:64]
DEST[MAXVL-1:128] ← 0

```

### ADDSD (128-bit Legacy SSE version)

```

DEST[63:0] ← DEST[63:0] + SRC[63:0]
DEST[MAXVL-1:64] (Unmodified)

```

## Intel C/C++ Compiler Intrinsic Equivalent

```

VADDSD __m128d __mm_mask_add_sd (__m128d s, __mmask8 k, __m128d a, __m128d b);
VADDSD __m128d __mm_maskz_add_sd (__mmask8 k, __m128d a, __m128d b);
VADDSD __m128d __mm_add_round_sd (__m128d a, __m128d b, int);
VADDSD __m128d __mm_mask_add_round_sd (__m128d s, __mmask8 k, __m128d a, __m128d b, int);
VADDSD __m128d __mm_maskz_add_round_sd (__mmask8 k, __m128d a, __m128d b, int);
ADDSD __m128d __mm_add_sd (__m128d a, __m128d b);

```

## SIMD Floating-Point Exceptions

Overflow, Underflow, Invalid, Precision, Denormal

## Other Exceptions

VEX-encoded instruction, see Exceptions Type 3.

EVEX-encoded instruction, see Exceptions Type E3.

## ADDSS—Add Scalar Single-Precision Floating-Point Values

Opcode/ Instruction	Op / En	64/32 bit Mode Support	CPUID Feature Flag	Description
F3 0F 58 /r ADDSS xmm1, xmm2/m32	A	V/V	SSE	Add the low single-precision floating-point value from xmm2/mem to xmm1 and store the result in xmm1.
VEX.NDS.LIG.F3.0F.WIG 58 /r VADDSS xmm1, xmm2, xmm3/m32	B	V/V	AVX	Add the low single-precision floating-point value from xmm3/mem to xmm2 and store the result in xmm1.
EVEX.NDS.LIG.F3.0F.W0 58 /r VADDSS xmm1{k1}{z}, xmm2, xmm3/m32{er}	C	V/V	AVX512F	Add the low single-precision floating-point value from xmm3/m32 to xmm2 and store the result in xmm1 with writemask k1.

### Instruction Operand Encoding

Op/En	Tuple Type	Operand 1	Operand 2	Operand 3	Operand 4
A	NA	ModRM:reg (r, w)	ModRM:r/m (r)	NA	NA
B	NA	ModRM:reg (w)	VEX.vvvv	ModRM:r/m (r)	NA
C	Tuple1 Scalar	ModRM:reg (w)	EVEX.vvvv	ModRM:r/m (r)	NA

### Description

Adds the low single-precision floating-point values from the second source operand and the first source operand, and stores the double-precision floating-point result in the destination operand.

The second source operand can be an XMM register or a 64-bit memory location. The first source and destination operands are XMM registers.

128-bit Legacy SSE version: The first source and destination operands are the same. Bits (MAXVL-1:32) of the corresponding the destination register remain unchanged.

EVEX and VEX.128 encoded version: The first source operand is encoded by EVEX.vvvv/VEX.vvvv. Bits (127:32) of the XMM register destination are copied from corresponding bits in the first source operand. Bits (MAXVL-1:128) of the destination register are zeroed.

EVEX version: The low doubleword element of the destination is updated according to the writemask.

Software should ensure VADDSS is encoded with VEX.L=0. Encoding VADDSS with VEX.L=1 may encounter unpredictable behavior across different processor generations.



## Operation

### VADDSS (EVEX encoded versions)

```

IF (EVEX.b = 1) AND SRC2 *is a register*
    THEN
        SET_RM(EVEX.RC);
    ELSE
        SET_RM(MXCSR.RM);
FI;
IF k1[0] or *no writemask*
    THEN DEST[31:0] ← SRC1[31:0] + SRC2[31:0]
    ELSE
        IF *merging-masking* ; merging-masking
            THEN *DEST[31:0] remains unchanged*
            ELSE ; zeroing-masking
                THEN DEST[31:0] ← 0
        FI;
FI;
DEST[127:32] ← SRC1[127:32]
DEST[MAXVL-1:128] ← 0

```

### VADDSS DEST, SRC1, SRC2 (VEX.128 encoded version)

```

DEST[31:0] ← SRC1[31:0] + SRC2[31:0]
DEST[127:32] ← SRC1[127:32]
DEST[MAXVL-1:128] ← 0

```

### ADDSS DEST, SRC (128-bit Legacy SSE version)

```

DEST[31:0] ← DEST[31:0] + SRC[31:0]
DEST[MAXVL-1:32] (Unmodified)

```

## Intel C/C++ Compiler Intrinsic Equivalent

```

VADDSS __m128 _mm_mask_add_ss (__m128 s, __mmask8 k, __m128 a, __m128 b);
VADDSS __m128 _mm_maskz_add_ss (__mmask8 k, __m128 a, __m128 b);
VADDSS __m128 _mm_add_round_ss (__m128 a, __m128 b, int);
VADDSS __m128 _mm_mask_add_round_ss (__m128 s, __mmask8 k, __m128 a, __m128 b, int);
VADDSS __m128 _mm_maskz_add_round_ss (__mmask8 k, __m128 a, __m128 b, int);
ADDSS __m128 _mm_add_ss (__m128 a, __m128 b);

```

## SIMD Floating-Point Exceptions

Overflow, Underflow, Invalid, Precision, Denormal

## Other Exceptions

VEX-encoded instruction, see Exceptions Type 3.

EVEX-encoded instruction, see Exceptions Type E3.

**ADDSUBPD—Packed Double-FP Add/Subtract**

Opcode/ Instruction	Op/ En	64/32-bit Mode	CPUID Feature Flag	Description
66 0F D0 /r ADDSUBPD <i>xmm1, xmm2/m128</i>	RM	V/V	SSE3	Add/subtract double-precision floating-point values from <i>xmm2/m128</i> to <i>xmm1</i> .
VEX.NDS.128.66.0F.WIG D0 /r VADDSUBPD <i>xmm1, xmm2, xmm3/m128</i>	RVM	V/V	AVX	Add/subtract packed double-precision floating-point values from <i>xmm3/mem</i> to <i>xmm2</i> and stores result in <i>xmm1</i> .
VEX.NDS.256.66.0F.WIG D0 /r VADDSUBPD <i>ymm1, ymm2, ymm3/m256</i>	RVM	V/V	AVX	Add / subtract packed double-precision floating-point values from <i>ymm3/mem</i> to <i>ymm2</i> and stores result in <i>ymm1</i> .

**Instruction Operand Encoding**

Op/En	Operand 1	Operand 2	Operand 3	Operand 4
RM	ModRM:reg ( <i>r, w</i> )	ModRM:r/m ( <i>r</i> )	NA	NA
RVM	ModRM:reg ( <i>w</i> )	VEX.vvvv ( <i>r</i> )	ModRM:r/m ( <i>r</i> )	NA

**Description**

Adds odd-numbered double-precision floating-point values of the first source operand (second operand) with the corresponding double-precision floating-point values from the second source operand (third operand); stores the result in the odd-numbered values of the destination operand (first operand). Subtracts the even-numbered double-precision floating-point values from the second source operand from the corresponding double-precision floating values in the first source operand; stores the result into the even-numbered values of the destination operand.

In 64-bit mode, using a REX prefix in the form of REX.R permits this instruction to access additional registers (XMM8-XMM15).

128-bit Legacy SSE version: The second source can be an XMM register or a 128-bit memory location. The destination is not distinct from the first source XMM register and the upper bits (MAXVL-1:128) of the corresponding YMM register destination are unmodified. See Figure 3-3.

VEX.128 encoded version: the first source operand is an XMM register or 128-bit memory location. The destination operand is an XMM register. The upper bits (MAXVL-1:128) of the corresponding YMM register destination are zeroed.

VEX.256 encoded version: The first source operand is a YMM register. The second source operand can be a YMM register or a 256-bit memory location. The destination operand is a YMM register.

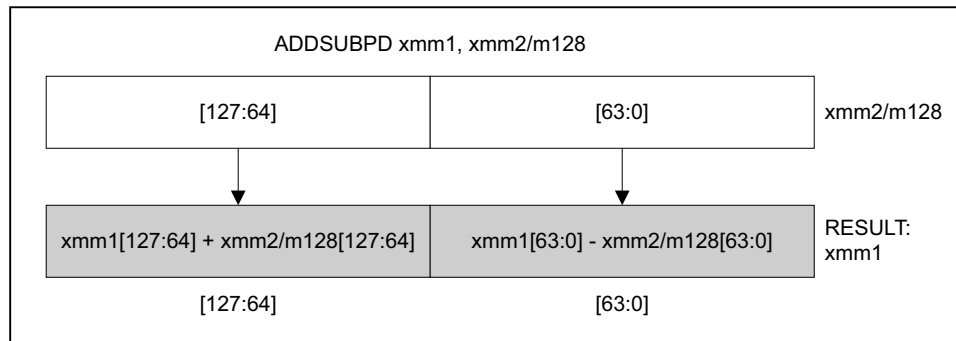

**Figure 3-3. ADDSUBPD—Packed Double-FP Add/Subtract**

### Operation

#### ADDSUBPD (128-bit Legacy SSE version)

DEST[63:0] ← DEST[63:0] - SRC[63:0]  
 DEST[127:64] ← DEST[127:64] + SRC[127:64]  
 DEST[MAXVL-1:128] (Unmodified)

#### VADDSUBPD (VEX.128 encoded version)

DEST[63:0] ← SRC1[63:0] - SRC2[63:0]  
 DEST[127:64] ← SRC1[127:64] + SRC2[127:64]  
 DEST[MAXVL-1:128] ← 0

#### VADDSUBPD (VEX.256 encoded version)

DEST[63:0] ← SRC1[63:0] - SRC2[63:0]  
 DEST[127:64] ← SRC1[127:64] + SRC2[127:64]  
 DEST[191:128] ← SRC1[191:128] - SRC2[191:128]  
 DEST[255:192] ← SRC1[255:192] + SRC2[255:192]

### Intel C/C++ Compiler Intrinsic Equivalent

ADDSUBPD: `__m128d _mm_addsub_pd(__m128d a, __m128d b)`

VADDSUBPD: `__m256d _mm256_addsub_pd(__m256d a, __m256d b)`

### Exceptions

When the source operand is a memory operand, it must be aligned on a 16-byte boundary or a general-protection exception (#GP) will be generated.

### SIMD Floating-Point Exceptions

Overflow, Underflow, Invalid, Precision, Denormal.

### Other Exceptions

See Exceptions Type 2.

**ADDSUBPS—Packed Single-FP Add/Subtract**

Opcode/ Instruction	Op/ En	64/32-bit Mode	CPUID Feature Flag	Description
F2 0F D0 /r ADDSUBPS <i>xmm1</i> , <i>xmm2/m128</i>	RM	V/V	SSE3	Add/subtract single-precision floating-point values from <i>xmm2/m128</i> to <i>xmm1</i> .
VEX.NDS.128.F2.0F.WIG D0 /r VADDSUBPS <i>xmm1</i> , <i>xmm2</i> , <i>xmm3/m128</i>	RVM	V/V	AVX	Add/subtract single-precision floating-point values from <i>xmm3/mem</i> to <i>xmm2</i> and stores result in <i>xmm1</i> .
VEX.NDS.256.F2.0F.WIG D0 /r VADDSUBPS <i>ymm1</i> , <i>ymm2</i> , <i>ymm3/m256</i>	RVM	V/V	AVX	Add / subtract single-precision floating-point values from <i>ymm3/mem</i> to <i>ymm2</i> and stores result in <i>ymm1</i> .

**Instruction Operand Encoding**

Op/En	Operand 1	Operand 2	Operand 3	Operand 4
RM	ModRM:reg ( <i>r</i> , <i>w</i> )	ModRM:r/m ( <i>r</i> )	NA	NA
RVM	ModRM:reg ( <i>w</i> )	VEX.vvvv ( <i>r</i> )	ModRM:r/m ( <i>r</i> )	NA

**Description**

Adds odd-numbered single-precision floating-point values of the first source operand (second operand) with the corresponding single-precision floating-point values from the second source operand (third operand); stores the result in the odd-numbered values of the destination operand (first operand). Subtracts the even-numbered single-precision floating-point values from the second source operand from the corresponding single-precision floating values in the first source operand; stores the result into the even-numbered values of the destination operand.

In 64-bit mode, using a REX prefix in the form of REX.R permits this instruction to access additional registers (XMM8-XMM15).

128-bit Legacy SSE version: The second source can be an XMM register or an 128-bit memory location. The destination is not distinct from the first source XMM register and the upper bits (MAXVL-1:128) of the corresponding YMM register destination are unmodified. See Figure 3-4.

VEX.128 encoded version: the first source operand is an XMM register or 128-bit memory location. The destination operand is an XMM register. The upper bits (MAXVL-1:128) of the corresponding YMM register destination are zeroed.

VEX.256 encoded version: The first source operand is a YMM register. The second source operand can be a YMM register or a 256-bit memory location. The destination operand is a YMM register.

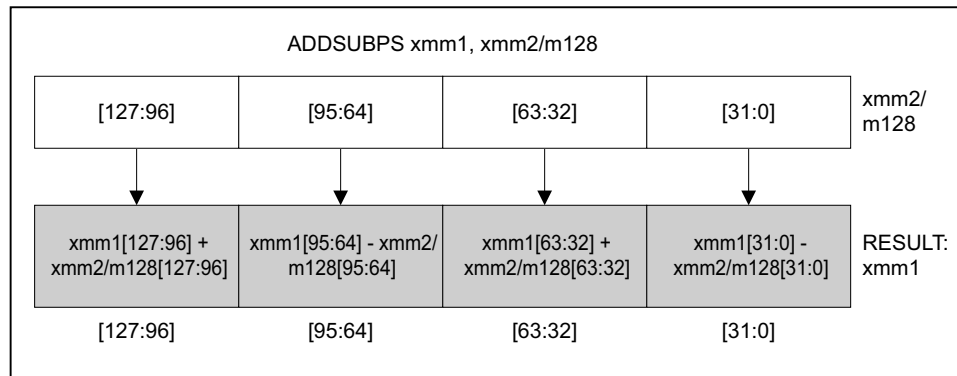

OM15992

Figure 3-4. ADDSUBBPS—Packed Single-FP Add/Subtract

### Operation

#### ADDSUBBPS (128-bit Legacy SSE version)

$DEST[31:0] \leftarrow DEST[31:0] - SRC[31:0]$   
 $DEST[63:32] \leftarrow DEST[63:32] + SRC[63:32]$   
 $DEST[95:64] \leftarrow DEST[95:64] - SRC[95:64]$   
 $DEST[127:96] \leftarrow DEST[127:96] + SRC[127:96]$   
 $DEST[MAXVL-1:128]$  (Unmodified)

#### VADDSUBBPS (VEX.128 encoded version)

$DEST[31:0] \leftarrow SRC1[31:0] - SRC2[31:0]$   
 $DEST[63:32] \leftarrow SRC1[63:32] + SRC2[63:32]$   
 $DEST[95:64] \leftarrow SRC1[95:64] - SRC2[95:64]$   
 $DEST[127:96] \leftarrow SRC1[127:96] + SRC2[127:96]$   
 $DEST[MAXVL-1:128] \leftarrow 0$

#### VADDSUBBPS (VEX.256 encoded version)

$DEST[31:0] \leftarrow SRC1[31:0] - SRC2[31:0]$   
 $DEST[63:32] \leftarrow SRC1[63:32] + SRC2[63:32]$   
 $DEST[95:64] \leftarrow SRC1[95:64] - SRC2[95:64]$   
 $DEST[127:96] \leftarrow SRC1[127:96] + SRC2[127:96]$   
 $DEST[159:128] \leftarrow SRC1[159:128] - SRC2[159:128]$   
 $DEST[191:160] \leftarrow SRC1[191:160] + SRC2[191:160]$   
 $DEST[223:192] \leftarrow SRC1[223:192] - SRC2[223:192]$   
 $DEST[255:224] \leftarrow SRC1[255:224] + SRC2[255:224]$

### Intel C/C++ Compiler Intrinsic Equivalent

ADDSUBBPS: `_mm128_mm_addsub_ps(__m128 a, __m128 b)`

VADDSUBBPS: `_mm256_mm256_addsub_ps(__m256 a, __m256 b)`

### Exceptions

When the source operand is a memory operand, the operand must be aligned on a 16-byte boundary or a general-protection exception (#GP) will be generated.

**SIMD Floating-Point Exceptions**

Overflow, Underflow, Invalid, Precision, Denormal.

**Other Exceptions**

See Exceptions Type 2.

## ADOX – Unsigned Integer Addition of Two Operands with Overflow Flag

Opcode/ Instruction	Op/ En	64/32bit Mode Support	CPUID Feature Flag	Description
F3 0F 38 F6 /r ADOX r32, r/m32	RM	V/V	ADX	Unsigned addition of r32 with OF, r/m32 to r32, writes OF.
F3 REX.w 0F 38 F6 /r ADOX r64, r/m64	RM	V/NE	ADX	Unsigned addition of r64 with OF, r/m64 to r64, writes OF.

### Instruction Operand Encoding

Op/En	Operand 1	Operand 2	Operand 3	Operand 4
RM	ModRM:reg (r, w)	ModRM:r/m (r)	NA	NA

### Description

Performs an unsigned addition of the destination operand (first operand), the source operand (second operand) and the overflow-flag (OF) and stores the result in the destination operand. The destination operand is a general-purpose register, whereas the source operand can be a general-purpose register or memory location. The state of OF represents a carry from a previous addition. The instruction sets the OF flag with the carry generated by the unsigned addition of the operands.

The ADOX instruction is executed in the context of multi-precision addition, where we add a series of operands with a carry-chain. At the beginning of a chain of additions, we execute an instruction to zero the OF (e.g. XOR).

This instruction is supported in real mode and virtual-8086 mode. The operand size is always 32 bits if not in 64-bit mode.

In 64-bit mode, the default operation size is 32 bits. Using a REX Prefix in the form of REX.R permits access to additional registers (R8-15). Using REX Prefix in the form of REX.W promotes operation to 64-bits.

ADOX executes normally either inside or outside a transaction region.

Note: ADOX defines the CF and OF flags differently than the ADD/ADC instructions as defined in *Intel® 64 and IA-32 Architectures Software Developer's Manual, Volume 2A*.

### Operation

IF OperandSize is 64-bit

```
THEN OF:DEST[63:0] ← DEST[63:0] + SRC[63:0] + OF;
ELSE OF:DEST[31:0] ← DEST[31:0] + SRC[31:0] + OF;
```

FI;

### Flags Affected

OF is updated based on result. CF, SF, ZF, AF and PF flags are unmodified.

### Intel C/C++ Compiler Intrinsic Equivalent

```
unsigned char _addcarryx_u32 (unsigned char c_in, unsigned int src1, unsigned int src2, unsigned int *sum_out);
```

```
unsigned char _addcarryx_u64 (unsigned char c_in, unsigned __int64 src1, unsigned __int64 src2, unsigned __int64 *sum_out);
```

### SIMD Floating-Point Exceptions

None

**Protected Mode Exceptions**

#UD	If the LOCK prefix is used. If CPUID.(EAX=07H, ECX=0H):EBX.ADX[bit 19] = 0.
#SS(0)	For an illegal address in the SS segment.
#GP(0)	For an illegal memory operand effective address in the CS, DS, ES, FS or GS segments. If the DS, ES, FS, or GS register is used to access memory and it contains a null segment selector.
#PF(fault-code)	For a page fault.
#AC(0)	If alignment checking is enabled and an unaligned memory reference is made while the current privilege level is 3.

**Real-Address Mode Exceptions**

#UD	If the LOCK prefix is used. If CPUID.(EAX=07H, ECX=0H):EBX.ADX[bit 19] = 0.
#SS(0)	For an illegal address in the SS segment.
#GP(0)	If any part of the operand lies outside the effective address space from 0 to FFFFH.

**Virtual-8086 Mode Exceptions**

#UD	If the LOCK prefix is used. If CPUID.(EAX=07H, ECX=0H):EBX.ADX[bit 19] = 0.
#SS(0)	For an illegal address in the SS segment.
#GP(0)	If any part of the operand lies outside the effective address space from 0 to FFFFH.
#PF(fault-code)	For a page fault.
#AC(0)	If alignment checking is enabled and an unaligned memory reference is made while the current privilege level is 3.

**Compatibility Mode Exceptions**

Same exceptions as in protected mode.

**64-Bit Mode Exceptions**

#UD	If the LOCK prefix is used. If CPUID.(EAX=07H, ECX=0H):EBX.ADX[bit 19] = 0.
#SS(0)	If a memory address referencing the SS segment is in a non-canonical form.
#GP(0)	If the memory address is in a non-canonical form.
#PF(fault-code)	For a page fault.
#AC(0)	If alignment checking is enabled and an unaligned memory reference is made while the current privilege level is 3.



## AESDEC—Perform One Round of an AES Decryption Flow

Opcode/ Instruction	Op/ En	64/32-bit Mode	CPUID Feature Flag	Description
66 0F 38 DE /r AESDEC xmm1, xmm2/m128	RM	V/V	AES	Perform one round of an AES decryption flow, using the Equivalent Inverse Cipher, operating on a 128-bit data (state) from xmm1 with a 128-bit round key from xmm2/m128.
VEX.NDS.128.66.0F38.WIG DE /r VAESDEC xmm1, xmm2, xmm3/m128	RVM	V/V	Both AES and AVX flags	Perform one round of an AES decryption flow, using the Equivalent Inverse Cipher, operating on a 128-bit data (state) from xmm2 with a 128-bit round key from xmm3/m128; store the result in xmm1.

### Instruction Operand Encoding

Op/En	Operand 1	Operand2	Operand3	Operand4
RM	ModRM:reg (r, w)	ModRM:r/m (r)	NA	NA
RVM	ModRM:reg (w)	VEX.vvvv (r)	ModRM:r/m (r)	NA

### Description

This instruction performs a single round of the AES decryption flow using the Equivalent Inverse Cipher, with the round key from the second source operand, operating on a 128-bit data (state) from the first source operand, and store the result in the destination operand.

Use the AESDEC instruction for all but the last decryption round. For the last decryption round, use the AESDECLAST instruction.

128-bit Legacy SSE version: The first source operand and the destination operand are the same and must be an XMM register. The second source operand can be an XMM register or a 128-bit memory location. Bits (MAXVL-1:128) of the corresponding YMM destination register remain unchanged.

VEX.128 encoded version: The first source operand and the destination operand are XMM registers. The second source operand can be an XMM register or a 128-bit memory location. Bits (MAXVL-1:128) of the destination YMM register are zeroed.

### Operation

#### AESDEC

```
STATE ← SRC1;
RoundKey ← SRC2;
STATE ← InvShiftRows( STATE );
STATE ← InvSubBytes( STATE );
STATE ← InvMixColumns( STATE );
DEST[127:0] ← STATE XOR RoundKey;
DEST[MAXVL-1:128] (Unmodified)
```

#### VAESDEC

```
STATE ← SRC1;
RoundKey ← SRC2;
STATE ← InvShiftRows( STATE );
STATE ← InvSubBytes( STATE );
STATE ← InvMixColumns( STATE );
DEST[127:0] ← STATE XOR RoundKey;
DEST[MAXVL-1:128] ← 0
```

### Intel C/C++ Compiler Intrinsic Equivalent

(V)AESDEC: `__m128i _mm_aesdec (__m128i, __m128i)`

### SIMD Floating-Point Exceptions

None

### Other Exceptions

See Exceptions Type 4.

## AESDECLAST—Perform Last Round of an AES Decryption Flow

Opcode/ Instruction	Op/ En	64/32-bit Mode	CPUID Feature Flag	Description
66 0F 38 DF /r AESDECLAST xmm1, xmm2/m128	RM	V/V	AES	Perform the last round of an AES decryption flow, using the Equivalent Inverse Cipher, operating on a 128-bit data (state) from xmm1 with a 128-bit round key from xmm2/m128.
VEX.NDS.128.66.0F38.WIG DF /r VAESDECLAST xmm1, xmm2, xmm3/m128	RVM	V/V	Both AES and AVX flags	Perform the last round of an AES decryption flow, using the Equivalent Inverse Cipher, operating on a 128-bit data (state) from xmm2 with a 128-bit round key from xmm3/m128; store the result in xmm1.

### Instruction Operand Encoding

Op/En	Operand 1	Operand2	Operand3	Operand4
RM	ModRM:reg (r, w)	ModRM:r/m (r)	NA	NA
RVM	ModRM:reg (w)	VEX.vvvv (r)	ModRM:r/m (r)	NA

### Description

This instruction performs the last round of the AES decryption flow using the Equivalent Inverse Cipher, with the round key from the second source operand, operating on a 128-bit data (state) from the first source operand, and store the result in the destination operand.

128-bit Legacy SSE version: The first source operand and the destination operand are the same and must be an XMM register. The second source operand can be an XMM register or a 128-bit memory location. Bits (MAXVL-1:128) of the corresponding YMM destination register remain unchanged.

VEX.128 encoded version: The first source operand and the destination operand are XMM registers. The second source operand can be an XMM register or a 128-bit memory location. Bits (MAXVL-1:128) of the destination YMM register are zeroed.

### Operation

#### AESDECLAST

```
STATE ← SRC1;
RoundKey ← SRC2;
STATE ← InvShiftRows( STATE );
STATE ← InvSubBytes( STATE );
DEST[127:0] ← STATE XOR RoundKey;
DEST[MAXVL-1:128] (Unmodified)
```

#### VAESDECLAST

```
STATE ← SRC1;
RoundKey ← SRC2;
STATE ← InvShiftRows( STATE );
STATE ← InvSubBytes( STATE );
DEST[127:0] ← STATE XOR RoundKey;
DEST[MAXVL-1:128] ← 0
```

### Intel C/C++ Compiler Intrinsic Equivalent

(V)AESDECLAST: `__m128i _mm_aesdeclast (__m128i, __m128i)`

**SIMD Floating-Point Exceptions**

None

**Other Exceptions**

See Exceptions Type 4.

## AESENC—Perform One Round of an AES Encryption Flow

Opcode/ Instruction	Op/ En	64/32-bit Mode	CPUID Feature Flag	Description
66 0F 38 DC /r AESENC xmm1, xmm2/m128	RM	V/V	AES	Perform one round of an AES encryption flow, operating on a 128-bit data (state) from xmm1 with a 128-bit round key from xmm2/m128.
VEX.NDS.128.66.0F38.WIG DC /r VAESENC xmm1, xmm2, xmm3/m128	RVM	V/V	Both AES and AVX flags	Perform one round of an AES encryption flow, operating on a 128-bit data (state) from xmm2 with a 128-bit round key from the xmm3/m128; store the result in xmm1.

### Instruction Operand Encoding

Op/En	Operand 1	Operand2	Operand3	Operand4
RM	ModRM:reg (r, w)	ModRM:r/m (r)	NA	NA
RVM	ModRM:reg (w)	VEX.vvvv (r)	ModRM:r/m (r)	NA

### Description

This instruction performs a single round of an AES encryption flow using a round key from the second source operand, operating on 128-bit data (state) from the first source operand, and store the result in the destination operand.

Use the AESENC instruction for all but the last encryption rounds. For the last encryption round, use the AESENC-CLAST instruction.

128-bit Legacy SSE version: The first source operand and the destination operand are the same and must be an XMM register. The second source operand can be an XMM register or a 128-bit memory location. Bits (MAXVL-1:128) of the corresponding YMM destination register remain unchanged.

VEX.128 encoded version: The first source operand and the destination operand are XMM registers. The second source operand can be an XMM register or a 128-bit memory location. Bits (MAXVL-1:128) of the destination YMM register are zeroed.

### Operation

#### AESENC

```
STATE ← SRC1;
RoundKey ← SRC2;
STATE ← ShiftRows( STATE );
STATE ← SubBytes( STATE );
STATE ← MixColumns( STATE );
DEST[127:0] ← STATE XOR RoundKey;
DEST[MAXVL-1:128] (Unmodified)
```

#### VAESENC

```
STATE ← SRC1;
RoundKey ← SRC2;
STATE ← ShiftRows( STATE );
STATE ← SubBytes( STATE );
STATE ← MixColumns( STATE );
DEST[127:0] ← STATE XOR RoundKey;
DEST[MAXVL-1:128] ← 0
```

### Intel C/C++ Compiler Intrinsic Equivalent

(V)AESENC: `__m128i _mm_aesenc (__m128i, __m128i)`

### SIMD Floating-Point Exceptions

None

### Other Exceptions

See Exceptions Type 4.

## AESENCLAST—Perform Last Round of an AES Encryption Flow

Opcode/ Instruction	Op/ En	64/32-bit Mode	CPUID Feature Flag	Description
66 0F 38 DD /r AESENCLAST xmm1, xmm2/m128	RM	V/V	AES	Perform the last round of an AES encryption flow, operating on a 128-bit data (state) from xmm1 with a 128-bit round key from xmm2/m128.
VEX.NDS.128.66.0F38.WIG DD /r VAESENCLAST xmm1, xmm2, xmm3/m128	RVM	V/V	Both AES and AVX flags	Perform the last round of an AES encryption flow, operating on a 128-bit data (state) from xmm2 with a 128 bit round key from xmm3/m128; store the result in xmm1.

### Instruction Operand Encoding

Op/En	Operand 1	Operand2	Operand3	Operand4
RM	ModRM:reg (r, w)	ModRM:r/m (r)	NA	NA
RVM	ModRM:reg (w)	VEX.vvvv (r)	ModRM:r/m (r)	NA

### Description

This instruction performs the last round of an AES encryption flow using a round key from the second source operand, operating on 128-bit data (state) from the first source operand, and store the result in the destination operand.

128-bit Legacy SSE version: The first source operand and the destination operand are the same and must be an XMM register. The second source operand can be an XMM register or a 128-bit memory location. Bits (MAXVL-1:128) of the corresponding YMM destination register remain unchanged.

VEX.128 encoded version: The first source operand and the destination operand are XMM registers. The second source operand can be an XMM register or a 128-bit memory location. Bits (MAXVL-1:128) of the destination YMM register are zeroed.

### Operation

#### AESENCLAST

```
STATE ← SRC1;
RoundKey ← SRC2;
STATE ← ShiftRows( STATE );
STATE ← SubBytes( STATE );
DEST[127:0] ← STATE XOR RoundKey;
DEST[MAXVL-1:128] (Unmodified)
```

#### VAESENCLAST

```
STATE ← SRC1;
RoundKey ← SRC2;
STATE ← ShiftRows( STATE );
STATE ← SubBytes( STATE );
DEST[127:0] ← STATE XOR RoundKey;
DEST[MAXVL-1:128] ← 0
```

### Intel C/C++ Compiler Intrinsic Equivalent

(V)AESENCLAST: `__m128i _mm_aesencast (__m128i, __m128i)`

**SIMD Floating-Point Exceptions**

None

**Other Exceptions**

See Exceptions Type 4.



## AESIMC—Perform the AES InvMixColumn Transformation

Opcode/ Instruction	Op/ En	64/32-bit Mode	CPUID Feature Flag	Description
66 0F 38 DB /r AESIMC xmm1, xmm2/m128	RM	V/V	AES	Perform the InvMixColumn transformation on a 128-bit round key from xmm2/m128 and store the result in xmm1.
VEX.128.66.0F38.WIG DB /r VAESIMC xmm1, xmm2/m128	RM	V/V	Both AES and AVX flags	Perform the InvMixColumn transformation on a 128-bit round key from xmm2/m128 and store the result in xmm1.

### Instruction Operand Encoding

Op/En	Operand 1	Operand2	Operand3	Operand4
RM	ModRM:reg (w)	ModRM:r/m (r)	NA	NA

### Description

Perform the InvMixColumns transformation on the source operand and store the result in the destination operand. The destination operand is an XMM register. The source operand can be an XMM register or a 128-bit memory location.

Note: the AESIMC instruction should be applied to the expanded AES round keys (except for the first and last round key) in order to prepare them for decryption using the “Equivalent Inverse Cipher” (defined in FIPS 197).

128-bit Legacy SSE version: Bits (MAXVL-1:128) of the corresponding YMM destination register remain unchanged.

VEX.128 encoded version: Bits (MAXVL-1:128) of the destination YMM register are zeroed.

Note: In VEX-encoded versions, VEX.vvvv is reserved and must be 1111b, otherwise instructions will #UD.

### Operation

#### AESIMC

DEST[127:0] ← InvMixColumns( SRC );  
DEST[MAXVL-1:128] (Unmodified)

#### VAESIMC

DEST[127:0] ← InvMixColumns( SRC );  
DEST[MAXVL-1:128] ← 0;

### Intel C/C++ Compiler Intrinsic Equivalent

(V)AESIMC: `__m128i _mm_aesimc (__m128i)`

### SIMD Floating-Point Exceptions

None

### Other Exceptions

See Exceptions Type 4; additionally

#UD If VEX.vvvv ≠ 1111B.

**AESKEYGENASSIST—AES Round Key Generation Assist**

Opcode/ Instruction	Op/ En	64/32-bit Mode	CPUID Feature Flag	Description
66 0F 3A DF /r ib AESKEYGENASSIST xmm1, xmm2/m128, imm8	RMI	V/V	AES	Assist in AES round key generation using an 8 bits Round Constant (RCON) specified in the immediate byte, operating on 128 bits of data specified in xmm2/m128 and stores the result in xmm1.
VEX.128.66.0F3A.WIG DF /r ib VAESKEYGENASSIST xmm1, xmm2/m128, imm8	RMI	V/V	Both AES and AVX flags	Assist in AES round key generation using 8 bits Round Constant (RCON) specified in the immediate byte, operating on 128 bits of data specified in xmm2/m128 and stores the result in xmm1.

**Instruction Operand Encoding**

Op/En	Operand 1	Operand2	Operand3	Operand4
RMI	ModRM:reg (w)	ModRM:r/m (r)	imm8	NA

**Description**

Assist in expanding the AES cipher key, by computing steps towards generating a round key for encryption, using 128-bit data specified in the source operand and an 8-bit round constant specified as an immediate, store the result in the destination operand.

The destination operand is an XMM register. The source operand can be an XMM register or a 128-bit memory location.

128-bit Legacy SSE version: Bits (MAXVL-1:128) of the corresponding YMM destination register remain unchanged.

VEX.128 encoded version: Bits (MAXVL-1:128) of the destination YMM register are zeroed.

Note: In VEX-encoded versions, VEX.vvvv is reserved and must be 1111b, otherwise instructions will #UD.

**Operation****AESKEYGENASSIST**

$X3[31:0] \leftarrow \text{SRC}[127:96];$

$X2[31:0] \leftarrow \text{SRC}[95:64];$

$X1[31:0] \leftarrow \text{SRC}[63:32];$

$X0[31:0] \leftarrow \text{SRC}[31:0];$

$\text{RCON}[31:0] \leftarrow \text{ZeroExtend}(\text{Imm8}[7:0]);$

$\text{DEST}[31:0] \leftarrow \text{SubWord}(X1);$

$\text{DEST}[63:32] \leftarrow \text{RotWord}(\text{SubWord}(X1)) \text{ XOR } \text{RCON};$

$\text{DEST}[95:64] \leftarrow \text{SubWord}(X3);$

$\text{DEST}[127:96] \leftarrow \text{RotWord}(\text{SubWord}(X3)) \text{ XOR } \text{RCON};$

$\text{DEST}[\text{MAXVL}-1:128] \text{ (Unmodified)}$

**VAESKEYGENASSIST**

$X3[31:0] \leftarrow \text{SRC}[127:96];$   
 $X2[31:0] \leftarrow \text{SRC}[95:64];$   
 $X1[31:0] \leftarrow \text{SRC}[63:32];$   
 $X0[31:0] \leftarrow \text{SRC}[31:0];$   
 $\text{RCON}[31:0] \leftarrow \text{ZeroExtend}(\text{Imm8}[7:0]);$   
 $\text{DEST}[31:0] \leftarrow \text{SubWord}(X1);$   
 $\text{DEST}[63:32] \leftarrow \text{RotWord}(\text{SubWord}(X1)) \text{ XOR } \text{RCON};$   
 $\text{DEST}[95:64] \leftarrow \text{SubWord}(X3);$   
 $\text{DEST}[127:96] \leftarrow \text{RotWord}(\text{SubWord}(X3)) \text{ XOR } \text{RCON};$   
 $\text{DEST}[\text{MAXVL}-1:128] \leftarrow 0;$

**Intel C/C++ Compiler Intrinsic Equivalent**

(V)AESKEYGENASSIST: `__m128i _mm_aeskeygenassist (__m128i, const int)`

**SIMD Floating-Point Exceptions**

None

**Other Exceptions**

See Exceptions Type 4; additionally

#UD If VEX.vvvv  $\neq$  1111B.

## AND—Logical AND

Opcode	Instruction	Op/En	64-bit Mode	Compat/Leg Mode	Description
24 <i>ib</i>	AND AL, <i>imm8</i>	I	Valid	Valid	AL AND <i>imm8</i> .
25 <i>iw</i>	AND AX, <i>imm16</i>	I	Valid	Valid	AX AND <i>imm16</i> .
25 <i>id</i>	AND EAX, <i>imm32</i>	I	Valid	Valid	EAX AND <i>imm32</i> .
REX.W + 25 <i>id</i>	AND RAX, <i>imm32</i>	I	Valid	N.E.	RAX AND <i>imm32</i> sign-extended to 64-bits.
80 /4 <i>ib</i>	AND <i>r/m8</i> , <i>imm8</i>	MI	Valid	Valid	<i>r/m8</i> AND <i>imm8</i> .
REX + 80 /4 <i>ib</i>	AND <i>r/m8</i> <sup>*</sup> , <i>imm8</i>	MI	Valid	N.E.	<i>r/m8</i> AND <i>imm8</i> .
81 /4 <i>iw</i>	AND <i>r/m16</i> , <i>imm16</i>	MI	Valid	Valid	<i>r/m16</i> AND <i>imm16</i> .
81 /4 <i>id</i>	AND <i>r/m32</i> , <i>imm32</i>	MI	Valid	Valid	<i>r/m32</i> AND <i>imm32</i> .
REX.W + 81 /4 <i>id</i>	AND <i>r/m64</i> , <i>imm32</i>	MI	Valid	N.E.	<i>r/m64</i> AND <i>imm32</i> sign extended to 64-bits.
83 /4 <i>ib</i>	AND <i>r/m16</i> , <i>imm8</i>	MI	Valid	Valid	<i>r/m16</i> AND <i>imm8</i> (sign-extended).
83 /4 <i>ib</i>	AND <i>r/m32</i> , <i>imm8</i>	MI	Valid	Valid	<i>r/m32</i> AND <i>imm8</i> (sign-extended).
REX.W + 83 /4 <i>ib</i>	AND <i>r/m64</i> , <i>imm8</i>	MI	Valid	N.E.	<i>r/m64</i> AND <i>imm8</i> (sign-extended).
20 /r	AND <i>r/m8</i> , <i>r8</i>	MR	Valid	Valid	<i>r/m8</i> AND <i>r8</i> .
REX + 20 /r	AND <i>r/m8</i> <sup>*</sup> , <i>r8</i> <sup>*</sup>	MR	Valid	N.E.	<i>r/m64</i> AND <i>r8</i> (sign-extended).
21 /r	AND <i>r/m16</i> , <i>r16</i>	MR	Valid	Valid	<i>r/m16</i> AND <i>r16</i> .
21 /r	AND <i>r/m32</i> , <i>r32</i>	MR	Valid	Valid	<i>r/m32</i> AND <i>r32</i> .
REX.W + 21 /r	AND <i>r/m64</i> , <i>r64</i>	MR	Valid	N.E.	<i>r/m64</i> AND <i>r32</i> .
22 /r	AND <i>r8</i> , <i>r/m8</i>	RM	Valid	Valid	<i>r8</i> AND <i>r/m8</i> .
REX + 22 /r	AND <i>r8</i> <sup>*</sup> , <i>r/m8</i> <sup>*</sup>	RM	Valid	N.E.	<i>r/m64</i> AND <i>r8</i> (sign-extended).
23 /r	AND <i>r16</i> , <i>r/m16</i>	RM	Valid	Valid	<i>r16</i> AND <i>r/m16</i> .
23 /r	AND <i>r32</i> , <i>r/m32</i>	RM	Valid	Valid	<i>r32</i> AND <i>r/m32</i> .
REX.W + 23 /r	AND <i>r64</i> , <i>r/m64</i>	RM	Valid	N.E.	<i>r64</i> AND <i>r/m64</i> .

### NOTES:

\*In 64-bit mode, *r/m8* can not be encoded to access the following byte registers if a REX prefix is used: AH, BH, CH, DH.

### Instruction Operand Encoding

Op/En	Operand 1	Operand 2	Operand 3	Operand 4
RM	ModRM:reg ( <i>r</i> , <i>w</i> )	ModRM:r/m ( <i>r</i> )	NA	NA
MR	ModRM:r/m ( <i>r</i> , <i>w</i> )	ModRM:reg ( <i>r</i> )	NA	NA
MI	ModRM:r/m ( <i>r</i> , <i>w</i> )	<i>imm8/16/32</i>	NA	NA
I	AL/AX/EAX/RAX	<i>imm8/16/32</i>	NA	NA

### Description

Performs a bitwise AND operation on the destination (first) and source (second) operands and stores the result in the destination operand location. The source operand can be an immediate, a register, or a memory location; the destination operand can be a register or a memory location. (However, two memory operands cannot be used in one instruction.) Each bit of the result is set to 1 if both corresponding bits of the first and second operands are 1; otherwise, it is set to 0.

This instruction can be used with a LOCK prefix to allow the it to be executed atomically.

In 64-bit mode, the instruction's default operation size is 32 bits. Using a REX prefix in the form of REX.R permits access to additional registers (R8-R15). Using a REX prefix in the form of REX.W promotes operation to 64 bits. See the summary chart at the beginning of this section for encoding data and limits.

## Operation

DEST ← DEST AND SRC;

## Flags Affected

The OF and CF flags are cleared; the SF, ZF, and PF flags are set according to the result. The state of the AF flag is undefined.

## Protected Mode Exceptions

#GP(0)	If the destination operand points to a non-writable segment. If a memory operand effective address is outside the CS, DS, ES, FS, or GS segment limit. If the DS, ES, FS, or GS register contains a NULL segment selector.
#SS(0)	If a memory operand effective address is outside the SS segment limit.
#PF(fault-code)	If a page fault occurs.
#AC(0)	If alignment checking is enabled and an unaligned memory reference is made while the current privilege level is 3.
#UD	If the LOCK prefix is used but the destination is not a memory operand.

## Real-Address Mode Exceptions

#GP	If a memory operand effective address is outside the CS, DS, ES, FS, or GS segment limit.
#SS	If a memory operand effective address is outside the SS segment limit.
#UD	If the LOCK prefix is used but the destination is not a memory operand.

## Virtual-8086 Mode Exceptions

#GP(0)	If a memory operand effective address is outside the CS, DS, ES, FS, or GS segment limit.
#SS(0)	If a memory operand effective address is outside the SS segment limit.
#PF(fault-code)	If a page fault occurs.
#AC(0)	If alignment checking is enabled and an unaligned memory reference is made.
#UD	If the LOCK prefix is used but the destination is not a memory operand.

## Compatibility Mode Exceptions

Same exceptions as in protected mode.

## 64-Bit Mode Exceptions

#SS(0)	If a memory address referencing the SS segment is in a non-canonical form.
#GP(0)	If the memory address is in a non-canonical form.
#PF(fault-code)	If a page fault occurs.
#AC(0)	If alignment checking is enabled and an unaligned memory reference is made while the current privilege level is 3.
#UD	If the LOCK prefix is used but the destination is not a memory operand.

**ANDN – Logical AND NOT**

Opcode/Instruction	Op/En	64/32-bit Mode	CPUID Feature Flag	Description
VEX.NDS.LZ.0F38.W0 F2 /r ANDN r32a, r32b, r/m32	RVM	V/V	BMI1	Bitwise AND of inverted r32b with r/m32, store result in r32a.
VEX.NDS.LZ.0F38.W1 F2 /r ANDN r64a, r64b, r/m64	RVM	V/NE	BMI1	Bitwise AND of inverted r64b with r/m64, store result in r64a.

**Instruction Operand Encoding**

Op/En	Operand 1	Operand 2	Operand 3	Operand 4
RVM	ModRM:reg (w)	VEX.vvvv (r)	ModRM:r/m (r)	NA

**Description**

Performs a bitwise logical AND of inverted second operand (the first source operand) with the third operand (the second source operand). The result is stored in the first operand (destination operand).

This instruction is not supported in real mode and virtual-8086 mode. The operand size is always 32 bits if not in 64-bit mode. In 64-bit mode operand size 64 requires VEX.W1. VEX.W1 is ignored in non-64-bit modes. An attempt to execute this instruction with VEX.L not equal to 0 will cause #UD.

**Operation**

DEST ← (NOT SRC1) bitwiseAND SRC2;

SF ← DEST[OperandSize - 1];

ZF ← (DEST = 0);

**Flags Affected**

SF and ZF are updated based on result. OF and CF flags are cleared. AF and PF flags are undefined.

**Intel C/C++ Compiler Intrinsic Equivalent**

Auto-generated from high-level language.

**SIMD Floating-Point Exceptions**

None

**Other Exceptions**

See Section 2.5.1, "Exception Conditions for VEX-Encoded GPR Instructions", Table 2-29; additionally

#UD If VEX.W = 1.

## ANDPD—Bitwise Logical AND of Packed Double Precision Floating-Point Values

Opcode/ Instruction	Op / En	64/32 bit Mode Support	CPUID Feature Flag	Description
66 0F 54 /r ANDPD xmm1, xmm2/m128	A	V/V	SSE2	Return the bitwise logical AND of packed double-precision floating-point values in xmm1 and xmm2/mem.
VEX.NDS.128.66.0F 54 /r VANDPD xmm1, xmm2, xmm3/m128	B	V/V	AVX	Return the bitwise logical AND of packed double-precision floating-point values in xmm2 and xmm3/mem.
VEX.NDS.256.66.0F 54 /r VANDPD ymm1, ymm2, ymm3/m256	B	V/V	AVX	Return the bitwise logical AND of packed double-precision floating-point values in ymm2 and ymm3/mem.
EVEX.NDS.128.66.0F.W1 54 /r VANDPD xmm1 {k1}{z}, xmm2, xmm3/m128/m64bcst	C	V/V	AVX512VL AVX512DQ	Return the bitwise logical AND of packed double-precision floating-point values in xmm2 and xmm3/m128/m64bcst subject to writemask k1.
EVEX.NDS.256.66.0F.W1 54 /r VANDPD ymm1 {k1}{z}, ymm2, ymm3/m256/m64bcst	C	V/V	AVX512VL AVX512DQ	Return the bitwise logical AND of packed double-precision floating-point values in ymm2 and ymm3/m256/m64bcst subject to writemask k1.
EVEX.NDS.512.66.0F.W1 54 /r VANDPD zmm1 {k1}{z}, zmm2, zmm3/m512/m64bcst	C	V/V	AVX512DQ	Return the bitwise logical AND of packed double-precision floating-point values in zmm2 and zmm3/m512/m64bcst subject to writemask k1.

### Instruction Operand Encoding

Op/En	Tuple Type	Operand 1	Operand 2	Operand 3	Operand 4
A	NA	ModRM:reg (r, w)	ModRM:r/m (r)	NA	NA
B	NA	ModRM:reg (w)	VEX.vvvv	ModRM:r/m (r)	NA
C	Full	ModRM:reg (w)	EVEX.vvvv	ModRM:r/m (r)	NA

### Description

Performs a bitwise logical AND of the two, four or eight packed double-precision floating-point values from the first source operand and the second source operand, and stores the result in the destination operand.

EVEX encoded versions: The first source operand is a ZMM/YMM/XMM register. The second source operand can be a ZMM/YMM/XMM register, a 512/256/128-bit memory location, or a 512/256/128-bit vector broadcasted from a 64-bit memory location. The destination operand is a ZMM/YMM/XMM register conditionally updated with writemask k1.

VEX.256 encoded version: The first source operand is a YMM register. The second source operand is a YMM register or a 256-bit memory location. The destination operand is a YMM register. The upper bits (MAXVL-1:256) of the corresponding ZMM register destination are zeroed.

VEX.128 encoded version: The first source operand is an XMM register. The second source operand is an XMM register or 128-bit memory location. The destination operand is an XMM register. The upper bits (MAXVL-1:128) of the corresponding ZMM register destination are zeroed.

128-bit Legacy SSE version: The second source can be an XMM register or an 128-bit memory location. The destination is not distinct from the first source XMM register and the upper bits (MAXVL-1:128) of the corresponding register destination are unmodified.

**Operation****VANDPD (EVEX encoded versions)**

(KL, VL) = (2, 128), (4, 256), (8, 512)

FOR j ← 0 TO KL-1

i ← j \* 64

IF k1[j] OR \*no writemask\*

THEN

IF (EVEX.b == 1) AND (SRC2 \*is memory\*)

THEN

DEST[i+63:i] ← SRC1[i+63:i] BITWISE AND SRC2[63:0]

ELSE

DEST[i+63:i] ← SRC1[i+63:i] BITWISE AND SRC2[i+63:i]

FI;

ELSE

IF \*merging-masking\* ; merging-masking

THEN \*DEST[i+63:i] remains unchanged\*

ELSE

; zeroing-masking

DEST[i+63:i] = 0

FI;

FI;

ENDFOR

DEST[MAXVL-1:VL] ← 0

**VANDPD (VEX.256 encoded version)**

DEST[63:0] ← SRC1[63:0] BITWISE AND SRC2[63:0]

DEST[127:64] ← SRC1[127:64] BITWISE AND SRC2[127:64]

DEST[191:128] ← SRC1[191:128] BITWISE AND SRC2[191:128]

DEST[255:192] ← SRC1[255:192] BITWISE AND SRC2[255:192]

DEST[MAXVL-1:256] ← 0

**VANDPD (VEX.128 encoded version)**

DEST[63:0] ← SRC1[63:0] BITWISE AND SRC2[63:0]

DEST[127:64] ← SRC1[127:64] BITWISE AND SRC2[127:64]

DEST[MAXVL-1:128] ← 0

**ANDPD (128-bit Legacy SSE version)**

DEST[63:0] ← DEST[63:0] BITWISE AND SRC[63:0]

DEST[127:64] ← DEST[127:64] BITWISE AND SRC[127:64]

DEST[MAXVL-1:128] (Unmodified)

**Intel C/C++ Compiler Intrinsic Equivalent**

VANDPD \_\_m512d \_\_mm512\_and\_pd (\_\_m512d a, \_\_m512d b);

VANDPD \_\_m512d \_\_mm512\_mask\_and\_pd (\_\_m512d s, \_\_mmask8 k, \_\_m512d a, \_\_m512d b);

VANDPD \_\_m512d \_\_mm512\_maskz\_and\_pd (\_\_mmask8 k, \_\_m512d a, \_\_m512d b);

VANDPD \_\_m256d \_\_mm256\_mask\_and\_pd (\_\_m256d s, \_\_mmask8 k, \_\_m256d a, \_\_m256d b);

VANDPD \_\_m256d \_\_mm256\_maskz\_and\_pd (\_\_mmask8 k, \_\_m256d a, \_\_m256d b);

VANDPD \_\_m128d \_\_mm\_mask\_and\_pd (\_\_m128d s, \_\_mmask8 k, \_\_m128d a, \_\_m128d b);

VANDPD \_\_m128d \_\_mm\_maskz\_and\_pd (\_\_mmask8 k, \_\_m128d a, \_\_m128d b);

VANDPD \_\_m256d \_\_mm256\_and\_pd (\_\_m256d a, \_\_m256d b);

ANDPD \_\_m128d \_\_mm\_and\_pd (\_\_m128d a, \_\_m128d b);

**SIMD Floating-Point Exceptions**

None



**Other Exceptions**

VEX-encoded instruction, see Exceptions Type 4.

EVEX-encoded instruction, see Exceptions Type E4.

## ANDPS—Bitwise Logical AND of Packed Single Precision Floating-Point Values

Opcode/ Instruction	Op/ En	64/32 bit Mode Support	CPUID Feature Flag	Description
NP OF 54 /r ANDPS xmm1, xmm2/m128	A	V/V	SSE	Return the bitwise logical AND of packed single-precision floating-point values in xmm1 and xmm2/mem.
VEX.NDS.128.OF 54 /r VANDPS xmm1, xmm2, xmm3/m128	B	V/V	AVX	Return the bitwise logical AND of packed single-precision floating-point values in xmm2 and xmm3/mem.
VEX.NDS.256.OF 54 /r VANDPS ymm1, ymm2, ymm3/m256	B	V/V	AVX	Return the bitwise logical AND of packed single-precision floating-point values in ymm2 and ymm3/mem.
EVEX.NDS.128.OF.W0 54 /r VANDPS xmm1 {k1}{z}, xmm2, xmm3/m128/m32bcst	C	V/V	AVX512VL AVX512DQ	Return the bitwise logical AND of packed single-precision floating-point values in xmm2 and xmm3/m128/m32bcst subject to writemask k1.
EVEX.NDS.256.OF.W0 54 /r VANDPS ymm1 {k1}{z}, ymm2, ymm3/m256/m32bcst	C	V/V	AVX512VL AVX512DQ	Return the bitwise logical AND of packed single-precision floating-point values in ymm2 and ymm3/m256/m32bcst subject to writemask k1.
EVEX.NDS.512.OF.W0 54 /r VANDPS zmm1 {k1}{z}, zmm2, zmm3/m512/m32bcst	C	V/V	AVX512DQ	Return the bitwise logical AND of packed single-precision floating-point values in zmm2 and zmm3/m512/m32bcst subject to writemask k1.

### Instruction Operand Encoding

Op/En	Tuple Type	Operand 1	Operand 2	Operand 3	Operand 4
A	NA	ModRM:reg (r, w)	ModRM:r/m (r)	NA	NA
B	NA	ModRM:reg (w)	VEX.vvvv	ModRM:r/m (r)	NA
C	Full	ModRM:reg (w)	EVEX.vvvv	ModRM:r/m (r)	NA

### Description

Performs a bitwise logical AND of the four, eight or sixteen packed single-precision floating-point values from the first source operand and the second source operand, and stores the result in the destination operand.

EVEX encoded versions: The first source operand is a ZMM/YMM/XMM register. The second source operand can be a ZMM/YMM/XMM register, a 512/256/128-bit memory location, or a 512/256/128-bit vector broadcasted from a 32-bit memory location. The destination operand is a ZMM/YMM/XMM register conditionally updated with writemask k1.

VEX.256 encoded version: The first source operand is a YMM register. The second source operand is a YMM register or a 256-bit memory location. The destination operand is a YMM register. The upper bits (MAXVL-1:256) of the corresponding ZMM register destination are zeroed.

VEX.128 encoded version: The first source operand is an XMM register. The second source operand is an XMM register or 128-bit memory location. The destination operand is an XMM register. The upper bits (MAXVL-1:128) of the corresponding ZMM register destination are zeroed.

128-bit Legacy SSE version: The second source can be an XMM register or an 128-bit memory location. The destination is not distinct from the first source XMM register and the upper bits (MAXVL-1:128) of the corresponding ZMM register destination are unmodified.

**Operation****VANDPS (EVEX encoded versions)**

(KL, VL) = (4, 128), (8, 256), (16, 512)

FOR j ← 0 TO KL-1

i ← j \* 32

IF k1[j] OR \*no writemask\*

IF (EVEX.b == 1) AND (SRC2 \*is memory\*)

THEN

DEST[i+63:i] ← SRC1[i+31:i] BITWISE AND SRC2[31:0]

ELSE

DEST[i+31:i] ← SRC1[i+31:i] BITWISE AND SRC2[i+31:i]

FI;

ELSE

IF \*merging-masking\* ; merging-masking

THEN \*DEST[i+31:i] remains unchanged\*

ELSE ; zeroing-masking

DEST[i+31:i] ← 0

FI;

FI;

ENDFOR

DEST[MAXVL-1:VL] ← 0;

**VANDPS (VEX.256 encoded version)**

DEST[31:0] ← SRC1[31:0] BITWISE AND SRC2[31:0]

DEST[63:32] ← SRC1[63:32] BITWISE AND SRC2[63:32]

DEST[95:64] ← SRC1[95:64] BITWISE AND SRC2[95:64]

DEST[127:96] ← SRC1[127:96] BITWISE AND SRC2[127:96]

DEST[159:128] ← SRC1[159:128] BITWISE AND SRC2[159:128]

DEST[191:160] ← SRC1[191:160] BITWISE AND SRC2[191:160]

DEST[223:192] ← SRC1[223:192] BITWISE AND SRC2[223:192]

DEST[255:224] ← SRC1[255:224] BITWISE AND SRC2[255:224].

DEST[MAXVL-1:256] ← 0;

**VANDPS (VEX.128 encoded version)**

DEST[31:0] ← SRC1[31:0] BITWISE AND SRC2[31:0]

DEST[63:32] ← SRC1[63:32] BITWISE AND SRC2[63:32]

DEST[95:64] ← SRC1[95:64] BITWISE AND SRC2[95:64]

DEST[127:96] ← SRC1[127:96] BITWISE AND SRC2[127:96]

DEST[MAXVL-1:128] ← 0;

**ANDPS (128-bit Legacy SSE version)**

DEST[31:0] ← DEST[31:0] BITWISE AND SRC[31:0]

DEST[63:32] ← DEST[63:32] BITWISE AND SRC[63:32]

DEST[95:64] ← DEST[95:64] BITWISE AND SRC[95:64]

DEST[127:96] ← DEST[127:96] BITWISE AND SRC[127:96]

DEST[MAXVL-1:128] (Unmodified)

### Intel C/C++ Compiler Intrinsic Equivalent

VANDPS \_\_m512 \_\_mm512\_and\_ps (\_\_m512 a, \_\_m512 b);  
VANDPS \_\_m512 \_\_mm512\_mask\_and\_ps (\_\_m512 s, \_\_mmask16 k, \_\_m512 a, \_\_m512 b);  
VANDPS \_\_m512 \_\_mm512\_maskz\_and\_ps (\_\_mmask16 k, \_\_m512 a, \_\_m512 b);  
VANDPS \_\_m256 \_\_mm256\_mask\_and\_ps (\_\_m256 s, \_\_mmask8 k, \_\_m256 a, \_\_m256 b);  
VANDPS \_\_m256 \_\_mm256\_maskz\_and\_ps (\_\_mmask8 k, \_\_m256 a, \_\_m256 b);  
VANDPS \_\_m128 \_\_mm\_mask\_and\_ps (\_\_m128 s, \_\_mmask8 k, \_\_m128 a, \_\_m128 b);  
VANDPS \_\_m128 \_\_mm\_maskz\_and\_ps (\_\_mmask8 k, \_\_m128 a, \_\_m128 b);  
VANDPS \_\_m256 \_\_mm256\_and\_ps (\_\_m256 a, \_\_m256 b);  
ANDPS \_\_m128 \_\_mm\_and\_ps (\_\_m128 a, \_\_m128 b);

### SIMD Floating-Point Exceptions

None

### Other Exceptions

VEX-encoded instruction, see Exceptions Type 4.

EVEX-encoded instruction, see Exceptions Type E4.

## ANDNPD—Bitwise Logical AND NOT of Packed Double Precision Floating-Point Values

Opcode/ Instruction	Op / En	64/32 bit Mode Support	CPUID Feature Flag	Description
66 0F 55 /r ANDNPD xmm1, xmm2/m128	A	V/V	SSE2	Return the bitwise logical AND NOT of packed double-precision floating-point values in xmm1 and xmm2/mem.
VEX.NDS.128.66.0F 55 /r VANDNPD xmm1, xmm2, xmm3/m128	B	V/V	AVX	Return the bitwise logical AND NOT of packed double-precision floating-point values in xmm2 and xmm3/mem.
VEX.NDS.256.66.0F 55/r VANDNPD ymm1, ymm2, ymm3/m256	B	V/V	AVX	Return the bitwise logical AND NOT of packed double-precision floating-point values in ymm2 and ymm3/mem.
EVEX.NDS.128.66.0F.W1 55 /r VANDNPD xmm1 {k1}{z}, xmm2, xmm3/m128/m64bcst	C	V/V	AVX512VL AVX512DQ	Return the bitwise logical AND NOT of packed double-precision floating-point values in xmm2 and xmm3/m128/m64bcst subject to writemask k1.
EVEX.NDS.256.66.0F.W1 55 /r VANDNPD ymm1 {k1}{z}, ymm2, ymm3/m256/m64bcst	C	V/V	AVX512VL AVX512DQ	Return the bitwise logical AND NOT of packed double-precision floating-point values in ymm2 and ymm3/m256/m64bcst subject to writemask k1.
EVEX.NDS.512.66.0F.W1 55 /r VANDNPD zmm1 {k1}{z}, zmm2, zmm3/m512/m64bcst	C	V/V	AVX512DQ	Return the bitwise logical AND NOT of packed double-precision floating-point values in zmm2 and zmm3/m512/m64bcst subject to writemask k1.

### Instruction Operand Encoding

Op/En	Tuple Type	Operand 1	Operand 2	Operand 3	Operand 4
A	NA	ModRM:reg (r, w)	ModRM:r/m (r)	NA	NA
B	NA	ModRM:reg (w)	VEX.vvvv	ModRM:r/m (r)	NA
C	Full	ModRM:reg (w)	EVEX.vvvv	ModRM:r/m (r)	NA

### Description

Performs a bitwise logical AND NOT of the two, four or eight packed double-precision floating-point values from the first source operand and the second source operand, and stores the result in the destination operand.

EVEX encoded versions: The first source operand is a ZMM/YMM/XMM register. The second source operand can be a ZMM/YMM/XMM register, a 512/256/128-bit memory location, or a 512/256/128-bit vector broadcasted from a 64-bit memory location. The destination operand is a ZMM/YMM/XMM register conditionally updated with writemask k1.

VEX.256 encoded version: The first source operand is a YMM register. The second source operand is a YMM register or a 256-bit memory location. The destination operand is a YMM register. The upper bits (MAXVL-1:256) of the corresponding ZMM register destination are zeroed.

VEX.128 encoded version: The first source operand is an XMM register. The second source operand is an XMM register or 128-bit memory location. The destination operand is an XMM register. The upper bits (MAXVL-1:128) of the corresponding ZMM register destination are zeroed.

128-bit Legacy SSE version: The second source can be an XMM register or an 128-bit memory location. The destination is not distinct from the first source XMM register and the upper bits (MAXVL-1:128) of the corresponding register destination are unmodified.

**Operation****VANDNPD (EVEX encoded versions)**

(KL, VL) = (2, 128), (4, 256), (8, 512)

FOR j ← 0 TO KL-1

i ← j \* 64

IF k1[j] OR \*no writemask\*

IF (EVEX.b == 1) AND (SRC2 \*is memory\*)

THEN

DEST[i+63:i] ← (NOT(SRC1[i+63:i])) BITWISE AND SRC2[63:0]

ELSE

DEST[i+63:i] ← (NOT(SRC1[i+63:i])) BITWISE AND SRC2[i+63:i]

FI;

ELSE

IF \*merging-masking\* ; merging-masking

THEN \*DEST[i+63:i] remains unchanged\*

ELSE ; zeroing-masking

DEST[i+63:i] = 0

FI;

FI;

ENDFOR

DEST[MAXVL-1:VL] ← 0

**VANDNPD (VEX.256 encoded version)**

DEST[63:0] ← (NOT(SRC1[63:0])) BITWISE AND SRC2[63:0]

DEST[127:64] ← (NOT(SRC1[127:64])) BITWISE AND SRC2[127:64]

DEST[191:128] ← (NOT(SRC1[191:128])) BITWISE AND SRC2[191:128]

DEST[255:192] ← (NOT(SRC1[255:192])) BITWISE AND SRC2[255:192]

DEST[MAXVL-1:256] ← 0

**VANDNPD (VEX.128 encoded version)**

DEST[63:0] ← (NOT(SRC1[63:0])) BITWISE AND SRC2[63:0]

DEST[127:64] ← (NOT(SRC1[127:64])) BITWISE AND SRC2[127:64]

DEST[MAXVL-1:128] ← 0

**ANDNPD (128-bit Legacy SSE version)**

DEST[63:0] ← (NOT(DEST[63:0])) BITWISE AND SRC[63:0]

DEST[127:64] ← (NOT(DEST[127:64])) BITWISE AND SRC[127:64]

DEST[MAXVL-1:128] (Unmodified)

**Intel C/C++ Compiler Intrinsic Equivalent**

VANDNPD \_\_m512d \_\_mm512\_andnot\_pd (\_\_m512d a, \_\_m512d b);

VANDNPD \_\_m512d \_\_mm512\_mask\_andnot\_pd (\_\_m512d s, \_\_mmask8 k, \_\_m512d a, \_\_m512d b);

VANDNPD \_\_m512d \_\_mm512\_maskz\_andnot\_pd (\_\_mmask8 k, \_\_m512d a, \_\_m512d b);

VANDNPD \_\_m256d \_\_mm256\_mask\_andnot\_pd (\_\_m256d s, \_\_mmask8 k, \_\_m256d a, \_\_m256d b);

VANDNPD \_\_m256d \_\_mm256\_maskz\_andnot\_pd (\_\_mmask8 k, \_\_m256d a, \_\_m256d b);

VANDNPD \_\_m128d \_\_mm\_mask\_andnot\_pd (\_\_m128d s, \_\_mmask8 k, \_\_m128d a, \_\_m128d b);

VANDNPD \_\_m128d \_\_mm\_maskz\_andnot\_pd (\_\_mmask8 k, \_\_m128d a, \_\_m128d b);

VANDNPD \_\_m256d \_\_mm256\_andnot\_pd (\_\_m256d a, \_\_m256d b);

ANDNPD \_\_m128d \_\_mm\_andnot\_pd (\_\_m128d a, \_\_m128d b);

**SIMD Floating-Point Exceptions**

None

**Other Exceptions**

VEX-encoded instruction, see Exceptions Type 4.

EVEX-encoded instruction, see Exceptions Type E4.

**ANDNPS—Bitwise Logical AND NOT of Packed Single Precision Floating-Point Values**

Opcode/ Instruction	Op / En	64/32 bit Mode Support	CPUID Feature Flag	Description
NP OF 55 /r ANDNPS xmm1, xmm2/m128	A	V/V	SSE	Return the bitwise logical AND NOT of packed single-precision floating-point values in xmm1 and xmm2/mem.
VEEX.NDS.128.OF 55 /r VANDNPS xmm1, xmm2, xmm3/m128	B	V/V	AVX	Return the bitwise logical AND NOT of packed single-precision floating-point values in xmm2 and xmm3/mem.
VEEX.NDS.256.OF 55 /r VANDNPS ymm1, ymm2, ymm3/m256	B	V/V	AVX	Return the bitwise logical AND NOT of packed single-precision floating-point values in ymm2 and ymm3/mem.
EVEX.NDS.128.OF.W0 55 /r VANDNPS xmm1 {k1}{z}, xmm2, xmm3/m128/m32bcst	C	V/V	AVX512VL AVX512DQ	Return the bitwise logical AND of packed single-precision floating-point values in xmm2 and xmm3/m128/m32bcst subject to writemask k1.
EVEX.NDS.256.OF.W0 55 /r VANDNPS ymm1 {k1}{z}, ymm2, ymm3/m256/m32bcst	C	V/V	AVX512VL AVX512DQ	Return the bitwise logical AND of packed single-precision floating-point values in ymm2 and ymm3/m256/m32bcst subject to writemask k1.
EVEX.NDS.512.OF.W0 55 /r VANDNPS zmm1 {k1}{z}, zmm2, zmm3/m512/m32bcst	C	V/V	AVX512DQ	Return the bitwise logical AND of packed single-precision floating-point values in zmm2 and zmm3/m512/m32bcst subject to writemask k1.

**Instruction Operand Encoding**

Op/En	Tuple Type	Operand 1	Operand 2	Operand 3	Operand 4
A	NA	ModRM:reg (r, w)	ModRM:r/m (r)	NA	NA
B	NA	ModRM:reg (w)	VEEX.vvvv	ModRM:r/m (r)	NA
C	Full	ModRM:reg (w)	EVEX.vvvv	ModRM:r/m (r)	NA

**Description**

Performs a bitwise logical AND NOT of the four, eight or sixteen packed single-precision floating-point values from the first source operand and the second source operand, and stores the result in the destination operand.

EVEX encoded versions: The first source operand is a ZMM/YMM/XMM register. The second source operand can be a ZMM/YMM/XMM register, a 512/256/128-bit memory location, or a 512/256/128-bit vector broadcasted from a 32-bit memory location. The destination operand is a ZMM/YMM/XMM register conditionally updated with writemask k1.

VEEX.256 encoded version: The first source operand is a YMM register. The second source operand is a YMM register or a 256-bit memory location. The destination operand is a YMM register. The upper bits (MAXVL-1:256) of the corresponding ZMM register destination are zeroed.

VEEX.128 encoded version: The first source operand is an XMM register. The second source operand is an XMM register or 128-bit memory location. The destination operand is an XMM register. The upper bits (MAXVL-1:128) of the corresponding ZMM register destination are zeroed.

128-bit Legacy SSE version: The second source can be an XMM register or an 128-bit memory location. The destination is not distinct from the first source XMM register and the upper bits (MAXVL-1:128) of the corresponding ZMM register destination are unmodified.



**Operation****VANDNPS (EVEX encoded versions)**

(KL, VL) = (4, 128), (8, 256), (16, 512)

FOR j ← 0 TO KL-1

i ← j \* 32

IF k1[j] OR \*no writemask\*

IF (EVEX.b == 1) AND (SRC2 \*is memory\*)

THEN

DEST[i+31:i] ← (NOT(SRC1[i+31:i])) BITWISE AND SRC2[31:0]

ELSE

DEST[i+31:i] ← (NOT(SRC1[i+31:i])) BITWISE AND SRC2[i+31:i]

FI;

ELSE

IF \*merging-masking\* ; merging-masking

THEN \*DEST[i+31:i] remains unchanged\*

ELSE ; zeroing-masking

DEST[i+31:i] = 0

FI;

FI;

ENDFOR

DEST[MAXVL-1:VL] ← 0

**VANDNPS (VEX.256 encoded version)**

DEST[31:0] ← (NOT(SRC1[31:0])) BITWISE AND SRC2[31:0]

DEST[63:32] ← (NOT(SRC1[63:32])) BITWISE AND SRC2[63:32]

DEST[95:64] ← (NOT(SRC1[95:64])) BITWISE AND SRC2[95:64]

DEST[127:96] ← (NOT(SRC1[127:96])) BITWISE AND SRC2[127:96]

DEST[159:128] ← (NOT(SRC1[159:128])) BITWISE AND SRC2[159:128]

DEST[191:160] ← (NOT(SRC1[191:160])) BITWISE AND SRC2[191:160]

DEST[223:192] ← (NOT(SRC1[223:192])) BITWISE AND SRC2[223:192]

DEST[255:224] ← (NOT(SRC1[255:224])) BITWISE AND SRC2[255:224].

DEST[MAXVL-1:256] ← 0

**VANDNPS (VEX.128 encoded version)**

DEST[31:0] ← (NOT(SRC1[31:0])) BITWISE AND SRC2[31:0]

DEST[63:32] ← (NOT(SRC1[63:32])) BITWISE AND SRC2[63:32]

DEST[95:64] ← (NOT(SRC1[95:64])) BITWISE AND SRC2[95:64]

DEST[127:96] ← (NOT(SRC1[127:96])) BITWISE AND SRC2[127:96]

DEST[MAXVL-1:128] ← 0

**ANDNPS (128-bit Legacy SSE version)**

DEST[31:0] ← (NOT(DEST[31:0])) BITWISE AND SRC[31:0]

DEST[63:32] ← (NOT(DEST[63:32])) BITWISE AND SRC[63:32]

DEST[95:64] ← (NOT(DEST[95:64])) BITWISE AND SRC[95:64]

DEST[127:96] ← (NOT(DEST[127:96])) BITWISE AND SRC[127:96]

DEST[MAXVL-1:128] (Unmodified)

**Intel C/C++ Compiler Intrinsic Equivalent**

VANDNPS \_\_m512 \_mm512\_andnot\_ps (\_\_m512 a, \_\_m512 b);  
 VANDNPS \_\_m512 \_mm512\_mask\_andnot\_ps (\_\_m512 s, \_\_mmask16 k, \_\_m512 a, \_\_m512 b);  
 VANDNPS \_\_m512 \_mm512\_maskz\_andnot\_ps (\_\_mmask16 k, \_\_m512 a, \_\_m512 b);  
 VANDNPS \_\_m256 \_mm256\_mask\_andnot\_ps (\_\_m256 s, \_\_mmask8 k, \_\_m256 a, \_\_m256 b);  
 VANDNPS \_\_m256 \_mm256\_maskz\_andnot\_ps (\_\_mmask8 k, \_\_m256 a, \_\_m256 b);  
 VANDNPS \_\_m128 \_mm\_mask\_andnot\_ps (\_\_m128 s, \_\_mmask8 k, \_\_m128 a, \_\_m128 b);  
 VANDNPS \_\_m128 \_mm\_maskz\_andnot\_ps (\_\_mmask8 k, \_\_m128 a, \_\_m128 b);  
 VANDNPS \_\_m256 \_mm256\_andnot\_ps (\_\_m256 a, \_\_m256 b);  
 ANDNPS \_\_m128 \_mm\_andnot\_ps (\_\_m128 a, \_\_m128 b);

**SIMD Floating-Point Exceptions**

None

**Other Exceptions**

VEX-encoded instruction, see Exceptions Type 4.

EVEX-encoded instruction, see Exceptions Type E4.

## ARPL—Adjust RPL Field of Segment Selector

Opcode	Instruction	Op/En	64-bit Mode	Compat/Leg Mode	Description
63 /r	ARPL r/m16, r16	Z0	N. E.	Valid	Adjust RPL of r/m16 to not less than RPL of r16.

### Instruction Operand Encoding

Op/En	Operand 1	Operand 2	Operand 3	Operand 4
Z0	ModRM:r/m (w)	ModRM:reg (r)	NA	NA

### Description

Compares the RPL fields of two segment selectors. The first operand (the destination operand) contains one segment selector and the second operand (source operand) contains the other. (The RPL field is located in bits 0 and 1 of each operand.) If the RPL field of the destination operand is less than the RPL field of the source operand, the ZF flag is set and the RPL field of the destination operand is increased to match that of the source operand. Otherwise, the ZF flag is cleared and no change is made to the destination operand. (The destination operand can be a word register or a memory location; the source operand must be a word register.)

The ARPL instruction is provided for use by operating-system procedures (however, it can also be used by applications). It is generally used to adjust the RPL of a segment selector that has been passed to the operating system by an application program to match the privilege level of the application program. Here the segment selector passed to the operating system is placed in the destination operand and segment selector for the application program's code segment is placed in the source operand. (The RPL field in the source operand represents the privilege level of the application program.) Execution of the ARPL instruction then ensures that the RPL of the segment selector received by the operating system is no lower (does not have a higher privilege) than the privilege level of the application program (the segment selector for the application program's code segment can be read from the stack following a procedure call).

This instruction executes as described in compatibility mode and legacy mode. It is not encodable in 64-bit mode.

See "Checking Caller Access Privileges" in Chapter 3, "Protected-Mode Memory Management," of the *Intel® 64 and IA-32 Architectures Software Developer's Manual, Volume 3A*, for more information about the use of this instruction.

### Operation

```

IF 64-BIT MODE
  THEN
    See MOVSSXD;
  ELSE
    IF DEST[RPL] < SRC[RPL]
      THEN
        ZF ← 1;
        DEST[RPL] ← SRC[RPL];
      ELSE
        ZF ← 0;
    FI;
  FI;

```

### Flags Affected

The ZF flag is set to 1 if the RPL field of the destination operand is less than that of the source operand; otherwise, it is set to 0.

### Protected Mode Exceptions

- #GP(0) If the destination is located in a non-writable segment.  
If a memory operand effective address is outside the CS, DS, ES, FS, or GS segment limit.  
If the DS, ES, FS, or GS register is used to access memory and it contains a NULL segment selector.
- #SS(0) If a memory operand effective address is outside the SS segment limit.
- #PF(fault-code) If a page fault occurs.
- #AC(0) If alignment checking is enabled and an unaligned memory reference is made while the current privilege level is 3.
- #UD If the LOCK prefix is used.

### Real-Address Mode Exceptions

- #UD The ARPL instruction is not recognized in real-address mode.  
If the LOCK prefix is used.

### Virtual-8086 Mode Exceptions

- #UD The ARPL instruction is not recognized in virtual-8086 mode.  
If the LOCK prefix is used.

### Compatibility Mode Exceptions

Same exceptions as in protected mode.

### 64-Bit Mode Exceptions

Not applicable.

## BLENDPD – Blend Packed Double Precision Floating-Point Values

Opcode/ Instruction	Op/ En	64/32-bit Mode	CPUID Feature Flag	Description
66 0F 3A 0D /r ib BLENDPD <i>xmm1, xmm2/m128, imm8</i>	RMI	V/V	SSE4_1	Select packed DP-FP values from <i>xmm1</i> and <i>xmm2/m128</i> from mask specified in <i>imm8</i> and store the values into <i>xmm1</i> .
VEX.NDS.128.66.0F3A.WIG OD /r ib VBLENDPD <i>xmm1, xmm2, xmm3/m128, imm8</i>	RVMI	V/V	AVX	Select packed double-precision floating-point Values from <i>xmm2</i> and <i>xmm3/m128</i> from mask in <i>imm8</i> and store the values in <i>xmm1</i> .
VEX.NDS.256.66.0F3A.WIG OD /r ib VBLENDPD <i>ymm1, ymm2, ymm3/m256, imm8</i>	RVMI	V/V	AVX	Select packed double-precision floating-point Values from <i>ymm2</i> and <i>ymm3/m256</i> from mask in <i>imm8</i> and store the values in <i>ymm1</i> .

### Instruction Operand Encoding

Op/En	Operand 1	Operand 2	Operand 3	Operand 4
RMI	ModRM:reg (r, w)	ModRM:r/m (r)	imm8	NA
RVMI	ModRM:reg (w)	VEX.vvvv (r)	ModRM:r/m (r)	imm8[3:0]

### Description

Double-precision floating-point values from the second source operand (third operand) are conditionally merged with values from the first source operand (second operand) and written to the destination operand (first operand). The immediate bits [3:0] determine whether the corresponding double-precision floating-point value in the destination is copied from the second source or first source. If a bit in the mask, corresponding to a word, is “1”, then the double-precision floating-point value in the second source operand is copied, else the value in the first source operand is copied.

128-bit Legacy SSE version: The second source can be an XMM register or a 128-bit memory location. The destination is not distinct from the first source XMM register and the upper bits (MAXVL-1:128) of the corresponding YMM register destination are unmodified.

VEX.128 encoded version: the first source operand is an XMM register. The second source operand is an XMM register or 128-bit memory location. The destination operand is an XMM register. The upper bits (MAXVL-1:128) of the corresponding YMM register destination are zeroed.

VEX.256 encoded version: The first source operand is a YMM register. The second source operand can be a YMM register or a 256-bit memory location. The destination operand is a YMM register.

### Operation

#### BLENDPD (128-bit Legacy SSE version)

```
IF (IMM8[0] = 0) THEN DEST[63:0] ← DEST[63:0]
    ELSE DEST [63:0] ← SRC[63:0] FI
IF (IMM8[1] = 0) THEN DEST[127:64] ← DEST[127:64]
    ELSE DEST [127:64] ← SRC[127:64] FI
DEST[MAXVL-1:128] (Unmodified)
```

#### VBLENDPD (VEX.128 encoded version)

```
IF (IMM8[0] = 0) THEN DEST[63:0] ← SRC1[63:0]
    ELSE DEST [63:0] ← SRC2[63:0] FI
IF (IMM8[1] = 0) THEN DEST[127:64] ← SRC1[127:64]
    ELSE DEST [127:64] ← SRC2[127:64] FI
DEST[MAXVL-1:128] ← 0
```

**VBLENDPD (VEX.256 encoded version)**

```

IF (IMM8[0] = 0) THEN DEST[63:0] ← SRC1[63:0]
    ELSE DEST [63:0] ← SRC2[63:0] FI
IF (IMM8[1] = 0) THEN DEST[127:64] ← SRC1[127:64]
    ELSE DEST [127:64] ← SRC2[127:64] FI
IF (IMM8[2] = 0) THEN DEST[191:128] ← SRC1[191:128]
    ELSE DEST [191:128] ← SRC2[191:128] FI
IF (IMM8[3] = 0) THEN DEST[255:192] ← SRC1[255:192]
    ELSE DEST [255:192] ← SRC2[255:192] FI

```

**Intel C/C++ Compiler Intrinsic Equivalent**

```
BLENDPD:    __m128d _mm_blend_pd (__m128d v1, __m128d v2, const int mask);
```

```
VBLENDPD:  __m256d _mm256_blend_pd (__m256d a, __m256d b, const int mask);
```

**SIMD Floating-Point Exceptions**

None

**Other Exceptions**

See Exceptions Type 4.

## BEXTR – Bit Field Extract

Opcode/Instruction	Op/En	64/32-bit Mode	CPUID Feature Flag	Description
VEX.NDS.LZ.OF38.W0 F7 /r BEXTR r32a, r/m32, r32b	RMV	V/V	BMI1	Contiguous bitwise extract from r/m32 using r32b as control; store result in r32a.
VEX.NDS.LZ.OF38.W1 F7 /r BEXTR r64a, r/m64, r64b	RMV	V/N.E.	BMI1	Contiguous bitwise extract from r/m64 using r64b as control; store result in r64a

### Instruction Operand Encoding

Op/En	Operand 1	Operand 2	Operand 3	Operand 4
RMV	ModRM:reg (w)	ModRM:r/m (r)	VEX.vvvv (r)	NA

### Description

Extracts contiguous bits from the first source operand (the second operand) using an index value and length value specified in the second source operand (the third operand). Bit 7:0 of the second source operand specifies the starting bit position of bit extraction. A START value exceeding the operand size will not extract any bits from the second source operand. Bit 15:8 of the second source operand specifies the maximum number of bits (LENGTH) beginning at the START position to extract. Only bit positions up to (OperandSize - 1) of the first source operand are extracted. The extracted bits are written to the destination register, starting from the least significant bit. All higher order bits in the destination operand (starting at bit position LENGTH) are zeroed. The destination register is cleared if no bits are extracted.

This instruction is not supported in real mode and virtual-8086 mode. The operand size is always 32 bits if not in 64-bit mode. In 64-bit mode operand size 64 requires VEX.W1. VEX.W1 is ignored in non-64-bit modes. An attempt to execute this instruction with VEX.L not equal to 0 will cause #UD.

### Operation

```
START ← SRC2[7:0];
LEN ← SRC2[15:8];
TEMP ← ZERO_EXTEND_TO_512 (SRC1 );
DEST ← ZERO_EXTEND(TEMP[START+LEN -1: START]);
ZF ← (DEST = 0);
```

### Flags Affected

ZF is updated based on the result. AF, SF, and PF are undefined. All other flags are cleared.

### Intel C/C++ Compiler Intrinsic Equivalent

```
BEXTR:    unsigned __int32 _bextr_u32(unsigned __int32 src, unsigned __int32 start, unsigned __int32 len);
```

```
BEXTR:    unsigned __int64 _bextr_u64(unsigned __int64 src, unsigned __int32 start, unsigned __int32 len);
```

### SIMD Floating-Point Exceptions

None

### Other Exceptions

See Section 2.5.1, "Exception Conditions for VEX-Encoded GPR Instructions", Table 2-29; additionally #UD If VEX.W = 1.

## BLENDPS – Blend Packed Single Precision Floating-Point Values

Opcode/ Instruction	Op/ En	64/32-bit Mode	CPUID Feature Flag	Description
66 0F 3A 0C /r ib BLENDPS xmm1, xmm2/m128, imm8	RMI	V/V	SSE4_1	Select packed single precision floating-point values from <i>xmm1</i> and <i>xmm2/m128</i> from mask specified in <i>imm8</i> and store the values into <i>xmm1</i> .
VEX.NDS.128.66.0F3A.WIG 0C /r ib VBLENDPS xmm1, xmm2, xmm3/m128, imm8	RVMI	V/V	AVX	Select packed single-precision floating-point values from <i>xmm2</i> and <i>xmm3/m128</i> from mask in <i>imm8</i> and store the values in <i>xmm1</i> .
VEX.NDS.256.66.0F3A.WIG 0C /r ib VBLENDPS ymm1, ymm2, ymm3/m256, imm8	RVMI	V/V	AVX	Select packed single-precision floating-point values from <i>ymm2</i> and <i>ymm3/m256</i> from mask in <i>imm8</i> and store the values in <i>ymm1</i> .

### Instruction Operand Encoding

Op/En	Operand 1	Operand 2	Operand 3	Operand 4
RMI	ModRM:reg (r, w)	ModRM:r/m (r)	imm8	NA
RVMI	ModRM:reg (w)	VEX.vvvv (r)	ModRM:r/m (r)	imm8

### Description

Packed single-precision floating-point values from the second source operand (third operand) are conditionally merged with values from the first source operand (second operand) and written to the destination operand (first operand). The immediate bits [7:0] determine whether the corresponding single precision floating-point value in the destination is copied from the second source or first source. If a bit in the mask, corresponding to a word, is "1", then the single-precision floating-point value in the second source operand is copied, else the value in the first source operand is copied.

128-bit Legacy SSE version: The second source can be an XMM register or an 128-bit memory location. The destination is not distinct from the first source XMM register and the upper bits (MAXVL-1:128) of the corresponding YMM register destination are unmodified.

VEX.128 encoded version: The first source operand an XMM register. The second source operand is an XMM register or 128-bit memory location. The destination operand is an XMM register. The upper bits (MAXVL-1:128) of the corresponding YMM register destination are zeroed.

VEX.256 encoded version: The first source operand is a YMM register. The second source operand can be a YMM register or a 256-bit memory location. The destination operand is a YMM register.

### Operation

#### BLENDPS (128-bit Legacy SSE version)

```
IF (IMM8[0] = 0) THEN DEST[31:0] ← DEST[31:0]
    ELSE DEST [31:0] ← SRC[31:0] FI
IF (IMM8[1] = 0) THEN DEST[63:32] ← DEST[63:32]
    ELSE DEST [63:32] ← SRC[63:32] FI
IF (IMM8[2] = 0) THEN DEST[95:64] ← DEST[95:64]
    ELSE DEST [95:64] ← SRC[95:64] FI
IF (IMM8[3] = 0) THEN DEST[127:96] ← DEST[127:96]
    ELSE DEST [127:96] ← SRC[127:96] FI
DEST[MAXVL-1:128] (Unmodified)
```



**VBLENDPS (VEX.128 encoded version)**

```

IF (IMM8[0] = 0) THEN DEST[31:0] ← SRC1[31:0]
    ELSE DEST [31:0] ← SRC2[31:0] FI
IF (IMM8[1] = 0) THEN DEST[63:32] ← SRC1[63:32]
    ELSE DEST [63:32] ← SRC2[63:32] FI
IF (IMM8[2] = 0) THEN DEST[95:64] ← SRC1[95:64]
    ELSE DEST [95:64] ← SRC2[95:64] FI
IF (IMM8[3] = 0) THEN DEST[127:96] ← SRC1[127:96]
    ELSE DEST [127:96] ← SRC2[127:96] FI
DEST[MAXVL-1:128] ← 0

```

**VBLENDPS (VEX.256 encoded version)**

```

IF (IMM8[0] = 0) THEN DEST[31:0] ← SRC1[31:0]
    ELSE DEST [31:0] ← SRC2[31:0] FI
IF (IMM8[1] = 0) THEN DEST[63:32] ← SRC1[63:32]
    ELSE DEST [63:32] ← SRC2[63:32] FI
IF (IMM8[2] = 0) THEN DEST[95:64] ← SRC1[95:64]
    ELSE DEST [95:64] ← SRC2[95:64] FI
IF (IMM8[3] = 0) THEN DEST[127:96] ← SRC1[127:96]
    ELSE DEST [127:96] ← SRC2[127:96] FI
IF (IMM8[4] = 0) THEN DEST[159:128] ← SRC1[159:128]
    ELSE DEST [159:128] ← SRC2[159:128] FI
IF (IMM8[5] = 0) THEN DEST[191:160] ← SRC1[191:160]
    ELSE DEST [191:160] ← SRC2[191:160] FI
IF (IMM8[6] = 0) THEN DEST[223:192] ← SRC1[223:192]
    ELSE DEST [223:192] ← SRC2[223:192] FI
IF (IMM8[7] = 0) THEN DEST[255:224] ← SRC1[255:224]
    ELSE DEST [255:224] ← SRC2[255:224] FI.

```

**Intel C/C++ Compiler Intrinsic Equivalent**

BLENDPS: `__m128 _mm_blend_ps (__m128 v1, __m128 v2, const int mask);`

VBLENDPS: `__m256 _mm256_blend_ps (__m256 a, __m256 b, const int mask);`

**SIMD Floating-Point Exceptions**

None

**Other Exceptions**

See Exceptions Type 4.

**BLENDVPD – Variable Blend Packed Double Precision Floating-Point Values**

Opcode/ Instruction	Op/ En	64/32-bit Mode	CPUID Feature Flag	Description
66 0F 38 15 /r BLENDVPD xmm1, xmm2/m128, <XMM0>	RMO	V/V	SSE4_1	Select packed DP FP values from <i>xmm1</i> and <i>xmm2</i> from mask specified in <i>XMM0</i> and store the values in <i>xmm1</i> .
VEX.NDS.128.66.0F3A.W0 4B /r /is4 VBLENDVPD xmm1, xmm2, xmm3/m128, xmm4	RVMR	V/V	AVX	Conditionally copy double-precision floating-point values from <i>xmm2</i> or <i>xmm3/m128</i> to <i>xmm1</i> , based on mask bits in the mask operand, <i>xmm4</i> .
VEX.NDS.256.66.0F3A.W0 4B /r /is4 VBLENDVPD ymm1, ymm2, ymm3/m256, ymm4	RVMR	V/V	AVX	Conditionally copy double-precision floating-point values from <i>ymm2</i> or <i>ymm3/m256</i> to <i>ymm1</i> , based on mask bits in the mask operand, <i>ymm4</i> .

**Instruction Operand Encoding**

Op/En	Operand 1	Operand 2	Operand 3	Operand 4
RMO	ModRM:reg (r, w)	ModRM:r/m (r)	implicit XMM0	NA
RVMR	ModRM:reg (w)	VEX.vvvv (r)	ModRM:r/m (r)	imm8[7:4]

**Description**

Conditionally copy each quadword data element of double-precision floating-point value from the second source operand and the first source operand depending on mask bits defined in the mask register operand. The mask bits are the most significant bit in each quadword element of the mask register.

Each quadword element of the destination operand is copied from:

- the corresponding quadword element in the second source operand, if a mask bit is “1”; or
- the corresponding quadword element in the first source operand, if a mask bit is “0”

The register assignment of the implicit mask operand for BLENDVPD is defined to be the architectural register XMM0.

128-bit Legacy SSE version: The first source operand and the destination operand is the same. Bits (MAXVL-1:128) of the corresponding YMM destination register remain unchanged. The mask register operand is implicitly defined to be the architectural register XMM0. An attempt to execute BLENDVPD with a VEX prefix will cause #UD.

VEX.128 encoded version: The first source operand and the destination operand are XMM registers. The second source operand is an XMM register or 128-bit memory location. The mask operand is the third source register, and encoded in bits[7:4] of the immediate byte(imm8). The bits[3:0] of imm8 are ignored. In 32-bit mode, imm8[7] is ignored. The upper bits (MAXVL-1:128) of the corresponding YMM register (destination register) are zeroed. VEX.W must be 0, otherwise, the instruction will #UD.

VEX.256 encoded version: The first source operand and destination operand are YMM registers. The second source operand can be a YMM register or a 256-bit memory location. The mask operand is the third source register, and encoded in bits[7:4] of the immediate byte(imm8). The bits[3:0] of imm8 are ignored. In 32-bit mode, imm8[7] is ignored. VEX.W must be 0, otherwise, the instruction will #UD.

VBLENDVPD permits the mask to be any XMM or YMM register. In contrast, BLENDVPD treats XMM0 implicitly as the mask and do not support non-destructive destination operation.

## Operation

### BLENDVPD (128-bit Legacy SSE version)

```

MASK ← XMM0
IF (MASK[63] = 0) THEN DEST[63:0] ← DEST[63:0]
    ELSE DEST [63:0] ← SRC[63:0] FI
IF (MASK[127] = 0) THEN DEST[127:64] ← DEST[127:64]
    ELSE DEST [127:64] ← SRC[127:64] FI
DEST[MAXVL-1:128] (Unmodified)

```

### VBLENDVPD (VEX.128 encoded version)

```

MASK ← SRC3
IF (MASK[63] = 0) THEN DEST[63:0] ← SRC1[63:0]
    ELSE DEST [63:0] ← SRC2[63:0] FI
IF (MASK[127] = 0) THEN DEST[127:64] ← SRC1[127:64]
    ELSE DEST [127:64] ← SRC2[127:64] FI
DEST[MAXVL-1:128] ← 0

```

### VBLENDVPD (VEX.256 encoded version)

```

MASK ← SRC3
IF (MASK[63] = 0) THEN DEST[63:0] ← SRC1[63:0]
    ELSE DEST [63:0] ← SRC2[63:0] FI
IF (MASK[127] = 0) THEN DEST[127:64] ← SRC1[127:64]
    ELSE DEST [127:64] ← SRC2[127:64] FI
IF (MASK[191] = 0) THEN DEST[191:128] ← SRC1[191:128]
    ELSE DEST [191:128] ← SRC2[191:128] FI
IF (MASK[255] = 0) THEN DEST[255:192] ← SRC1[255:192]
    ELSE DEST [255:192] ← SRC2[255:192] FI

```

## Intel C/C++ Compiler Intrinsic Equivalent

BLENDVPD: `__m128d_mm_blendv_pd(__m128d v1, __m128d v2, __m128d v3);`

VBLENDVPD: `__m128_mm_blendv_pd (__m128d a, __m128d b, __m128d mask);`

VBLENDVPD: `__m256_mm256_blendv_pd (__m256d a, __m256d b, __m256d mask);`

## SIMD Floating-Point Exceptions

None

## Other Exceptions

See Exceptions Type 4; additionally

#UD If VEX.W = 1.

**BLENDVPS — Variable Blend Packed Single Precision Floating-Point Values**

Opcode/ Instruction	Op/ En	64/32-bit Mode	CPUID Feature Flag	Description
66 0F 38 14 /r BLENDVPS <i>xmm1, xmm2/m128, &lt;XMM0&gt;</i>	RMO	V/V	SSE4_1	Select packed single precision floating-point values from <i>xmm1</i> and <i>xmm2/m128</i> from mask specified in <i>XMM0</i> and store the values into <i>xmm1</i> .
VEX.NDS.128.66.0F3A.W0 4A /r /is4 VBLENDVPS <i>xmm1, xmm2, xmm3/m128, xmm4</i>	RVMR	V/V	AVX	Conditionally copy single-precision floating-point values from <i>xmm2</i> or <i>xmm3/m128</i> to <i>xmm1</i> , based on mask bits in the specified mask operand, <i>xmm4</i> .
VEX.NDS.256.66.0F3A.W0 4A /r /is4 VBLENDVPS <i>ymm1, ymm2, ymm3/m256, ymm4</i>	RVMR	V/V	AVX	Conditionally copy single-precision floating-point values from <i>ymm2</i> or <i>ymm3/m256</i> to <i>ymm1</i> , based on mask bits in the specified mask register, <i>ymm4</i> .

**Instruction Operand Encoding**

Op/En	Operand 1	Operand 2	Operand 3	Operand 4
RMO	ModRM:reg (r, w)	ModRM:r/m (r)	implicit XMM0	NA
RVMR	ModRM:reg (w)	VEX.vvvv (r)	ModRM:r/m (r)	imm8[7:4]

**Description**

Conditionally copy each dword data element of single-precision floating-point value from the second source operand and the first source operand depending on mask bits defined in the mask register operand. The mask bits are the most significant bit in each dword element of the mask register.

Each quadword element of the destination operand is copied from:

- the corresponding dword element in the second source operand, if a mask bit is "1"; or
- the corresponding dword element in the first source operand, if a mask bit is "0"

The register assignment of the implicit mask operand for BLENDVPS is defined to be the architectural register XMM0.

128-bit Legacy SSE version: The first source operand and the destination operand is the same. Bits (MAXVL-1:128) of the corresponding YMM destination register remain unchanged. The mask register operand is implicitly defined to be the architectural register XMM0. An attempt to execute BLENDVPS with a VEX prefix will cause #UD.

VEX.128 encoded version: The first source operand and the destination operand are XMM registers. The second source operand is an XMM register or 128-bit memory location. The mask operand is the third source register, and encoded in bits[7:4] of the immediate byte(imm8). The bits[3:0] of imm8 are ignored. In 32-bit mode, imm8[7] is ignored. The upper bits (MAXVL-1:128) of the corresponding YMM register (destination register) are zeroed. VEX.W must be 0, otherwise, the instruction will #UD.

VEX.256 encoded version: The first source operand and destination operand are YMM registers. The second source operand can be a YMM register or a 256-bit memory location. The mask operand is the third source register, and encoded in bits[7:4] of the immediate byte(imm8). The bits[3:0] of imm8 are ignored. In 32-bit mode, imm8[7] is ignored. VEX.W must be 0, otherwise, the instruction will #UD.

VBLENDVPS permits the mask to be any XMM or YMM register. In contrast, BLENDVPS treats XMM0 implicitly as the mask and do not support non-destructive destination operation.

## Operation

### BLENDVPS (128-bit Legacy SSE version)

```

MASK ← XMM0
IF (MASK[31] = 0) THEN DEST[31:0] ← DEST[31:0]
    ELSE DEST [31:0] ← SRC[31:0] FI
IF (MASK[63] = 0) THEN DEST[63:32] ← DEST[63:32]
    ELSE DEST [63:32] ← SRC[63:32] FI
IF (MASK[95] = 0) THEN DEST[95:64] ← DEST[95:64]
    ELSE DEST [95:64] ← SRC[95:64] FI
IF (MASK[127] = 0) THEN DEST[127:96] ← DEST[127:96]
    ELSE DEST [127:96] ← SRC[127:96] FI
DEST[MAXVL-1:128] (Unmodified)

```

### VBLENDVPS (VEX.128 encoded version)

```

MASK ← SRC3
IF (MASK[31] = 0) THEN DEST[31:0] ← SRC1[31:0]
    ELSE DEST [31:0] ← SRC2[31:0] FI
IF (MASK[63] = 0) THEN DEST[63:32] ← SRC1[63:32]
    ELSE DEST [63:32] ← SRC2[63:32] FI
IF (MASK[95] = 0) THEN DEST[95:64] ← SRC1[95:64]
    ELSE DEST [95:64] ← SRC2[95:64] FI
IF (MASK[127] = 0) THEN DEST[127:96] ← SRC1[127:96]
    ELSE DEST [127:96] ← SRC2[127:96] FI
DEST[MAXVL-1:128] ← 0

```

### VBLENDVPS (VEX.256 encoded version)

```

MASK ← SRC3
IF (MASK[31] = 0) THEN DEST[31:0] ← SRC1[31:0]
    ELSE DEST [31:0] ← SRC2[31:0] FI
IF (MASK[63] = 0) THEN DEST[63:32] ← SRC1[63:32]
    ELSE DEST [63:32] ← SRC2[63:32] FI
IF (MASK[95] = 0) THEN DEST[95:64] ← SRC1[95:64]
    ELSE DEST [95:64] ← SRC2[95:64] FI
IF (MASK[127] = 0) THEN DEST[127:96] ← SRC1[127:96]
    ELSE DEST [127:96] ← SRC2[127:96] FI
IF (MASK[159] = 0) THEN DEST[159:128] ← SRC1[159:128]
    ELSE DEST [159:128] ← SRC2[159:128] FI
IF (MASK[191] = 0) THEN DEST[191:160] ← SRC1[191:160]
    ELSE DEST [191:160] ← SRC2[191:160] FI
IF (MASK[223] = 0) THEN DEST[223:192] ← SRC1[223:192]
    ELSE DEST [223:192] ← SRC2[223:192] FI
IF (MASK[255] = 0) THEN DEST[255:224] ← SRC1[255:224]
    ELSE DEST [255:224] ← SRC2[255:224] FI

```

## Intel C/C++ Compiler Intrinsic Equivalent

```

BLENDVPS:   __m128_mm_blendv_ps(__m128 v1, __m128 v2, __m128 v3);
VBLENDVPS: __m128_mm_blendv_ps (__m128 a, __m128 b, __m128 mask);
VBLENDVPS: __m256_mm256_blendv_ps (__m256 a, __m256 b, __m256 mask);

```

## SIMD Floating-Point Exceptions

None

**Other Exceptions**

See Exceptions Type 4; additionally  
#UD                      If VEX.W = 1.

## BLSI – Extract Lowest Set Isolated Bit

Opcode/Instruction	Op/En	64/32-bit Mode	CPUID Feature Flag	Description
VEX.NDD.LZ.OF38.W0 F3 /3 BLSI r32, r/m32	VM	V/V	BMI1	Extract lowest set bit from r/m32 and set that bit in r32.
VEX.NDD.LZ.OF38.W1 F3 /3 BLSI r64, r/m64	VM	V/N.E.	BMI1	Extract lowest set bit from r/m64, and set that bit in r64.

### Instruction Operand Encoding

Op/En	Operand 1	Operand 2	Operand 3	Operand 4
VM	VEX.vvvv (w)	ModRM:r/m (r)	NA	NA

### Description

Extracts the lowest set bit from the source operand and set the corresponding bit in the destination register. All other bits in the destination operand are zeroed. If no bits are set in the source operand, BLSI sets all the bits in the destination to 0 and sets ZF and CF.

This instruction is not supported in real mode and virtual-8086 mode. The operand size is always 32 bits if not in 64-bit mode. In 64-bit mode operand size 64 requires VEX.W1. VEX.W1 is ignored in non-64-bit modes. An attempt to execute this instruction with VEX.L not equal to 0 will cause #UD.

### Operation

```
temp ← (-SRC) bitwiseAND (SRC);
SF ← temp[OperandSize -1];
ZF ← (temp = 0);
IF SRC = 0
    CF ← 0;
ELSE
    CF ← 1;
FI
DEST ← temp;
```

### Flags Affected

ZF and SF are updated based on the result. CF is set if the source is not zero. OF flags are cleared. AF and PF flags are undefined.

### Intel C/C++ Compiler Intrinsic Equivalent

BLSI: `unsigned __int32 _bsi_u32(unsigned __int32 src);`

BLSI: `unsigned __int64 _bsi_u64(unsigned __int64 src);`

### SIMD Floating-Point Exceptions

None

### Other Exceptions

See Section 2.5.1, “Exception Conditions for VEX-Encoded GPR Instructions”, Table 2-29; additionally #UD If VEX.W = 1.

**BLSMSK – Get Mask Up to Lowest Set Bit**

Opcode/Instruction	Op/En	64/32-bit Mode	CPUID Feature Flag	Description
VEX.NDD.LZ.OF38.W0 F3 /2 BLSMSK r32, r/m32	VM	V/V	BMI1	Set all lower bits in r32 to “1” starting from bit 0 to lowest set bit in r/m32.
VEX.NDD.LZ.OF38.W1 F3 /2 BLSMSK r64, r/m64	VM	V/N.E.	BMI1	Set all lower bits in r64 to “1” starting from bit 0 to lowest set bit in r/m64.

**Instruction Operand Encoding**

Op/En	Operand 1	Operand 2	Operand 3	Operand 4
VM	VEX.vvvv (w)	ModRM:r/m (r)	NA	NA

**Description**

Sets all the lower bits of the destination operand to “1” up to and including lowest set bit (=1) in the source operand. If source operand is zero, BLSMSK sets all bits of the destination operand to 1 and also sets CF to 1.

This instruction is not supported in real mode and virtual-8086 mode. The operand size is always 32 bits if not in 64-bit mode. In 64-bit mode operand size 64 requires VEX.W1. VEX.W1 is ignored in non-64-bit modes. An attempt to execute this instruction with VEX.L not equal to 0 will cause #UD.

**Operation**

```
temp ← (SRC-1) XOR (SRC);
SF ← temp[OperandSize -1];
ZF ← 0;
IF SRC = 0
    CF ← 1;
ELSE
    CF ← 0;
FI
DEST ← temp;
```

**Flags Affected**

SF is updated based on the result. CF is set if the source is zero. ZF and OF flags are cleared. AF and PF flag are undefined.

**Intel C/C++ Compiler Intrinsic Equivalent**

BLSMSK: `unsigned __int32 _blsmask_u32(unsigned __int32 src);`

BLSMSK: `unsigned __int64 _blsmask_u64(unsigned __int64 src);`

**SIMD Floating-Point Exceptions**

None

**Other Exceptions**

See Section 2.5.1, “Exception Conditions for VEX-Encoded GPR Instructions”, Table 2-29; additionally

#UD If VEX.W = 1.



## BLSR — Reset Lowest Set Bit

Opcode/Instruction	Op/En	64/32-bit Mode	CPUID Feature Flag	Description
VEX.NDD.LZ.OF38.W0 F3 /1 BLSR r32, r/m32	VM	V/V	BMI1	Reset lowest set bit of r/m32, keep all other bits of r/m32 and write result to r32.
VEX.NDD.LZ.OF38.W1 F3 /1 BLSR r64, r/m64	VM	V/N.E.	BMI1	Reset lowest set bit of r/m64, keep all other bits of r/m64 and write result to r64.

### Instruction Operand Encoding

Op/En	Operand 1	Operand 2	Operand 3	Operand 4
VM	VEX.vvvv (w)	ModRM:r/m (r)	NA	NA

### Description

Copies all bits from the source operand to the destination operand and resets (=0) the bit position in the destination operand that corresponds to the lowest set bit of the source operand. If the source operand is zero BLSR sets CF.

This instruction is not supported in real mode and virtual-8086 mode. The operand size is always 32 bits if not in 64-bit mode. In 64-bit mode operand size 64 requires VEX.W1. VEX.W1 is ignored in non-64-bit modes. An attempt to execute this instruction with VEX.L not equal to 0 will cause #UD.

### Operation

```
temp ← (SRC-1) bitwiseAND ( SRC );
SF ← temp[OperandSize -1];
ZF ← (temp = 0);
IF SRC = 0
    CF ← 1;
ELSE
    CF ← 0;
FI
DEST ← temp;
```

### Flags Affected

ZF and SF flags are updated based on the result. CF is set if the source is zero. OF flag is cleared. AF and PF flags are undefined.

### Intel C/C++ Compiler Intrinsic Equivalent

BLSR: `unsigned __int32 _blsr_u32(unsigned __int32 src);`

BLSR: `unsigned __int64 _blsr_u64(unsigned __int64 src);`

### SIMD Floating-Point Exceptions

None

### Other Exceptions

See Section 2.5.1, "Exception Conditions for VEX-Encoded GPR Instructions", Table 2-29; additionally  
#UD If VEX.W = 1.

## BNDCL—Check Lower Bound

Opcode/ Instruction	Op/En	64/32 bit Mode Support	CPUID Feature Flag	Description
F3 0F 1A /r BNDCL bnd, r/m32	RM	NE/V	MPX	Generate a #BR if the address in r/m32 is lower than the lower bound in bnd.LB.
F3 0F 1A /r BNDCL bnd, r/m64	RM	V/NE	MPX	Generate a #BR if the address in r/m64 is lower than the lower bound in bnd.LB.

### Instruction Operand Encoding

Op/En	Operand 1	Operand 2	Operand 3
RM	ModRM:reg (w)	ModRM:r/m (r)	NA

### Description

Compare the address in the second operand with the lower bound in bnd. The second operand can be either a register or memory operand. If the address is lower than the lower bound in bnd.LB, it will set BNDSTATUS to 01H and signal a #BR exception.

This instruction does not cause any memory access, and does not read or write any flags.

### Operation

#### BNDCL BND, reg

```
IF reg < BND.LB Then
    BNDSTATUS ← 01H;
    #BR;
FI;
```

#### BNDCL BND, mem

```
TEMP ← LEA(mem);
IF TEMP < BND.LB Then
    BNDSTATUS ← 01H;
    #BR;
FI;
```

### Intel C/C++ Compiler Intrinsic Equivalent

```
BNDCL void _bnd_chk_ptr_lbounds(const void *q)
```

### Flags Affected

None

### Protected Mode Exceptions

#BR If lower bound check fails.

#UD If the LOCK prefix is used.  
If ModRM.r/m encodes BND4-BND7 when Intel MPX is enabled.  
If 67H prefix is not used and CS.D=0.  
If 67H prefix is used and CS.D=1.

### Real-Address Mode Exceptions

#BR	If lower bound check fails.
#UD	If the LOCK prefix is used. If ModRM.r/m encodes BND4-BND7 when Intel MPX is enabled. If 16-bit addressing is used.

### Virtual-8086 Mode Exceptions

#BR	If lower bound check fails.
#UD	If the LOCK prefix is used. If ModRM.r/m encodes BND4-BND7 when Intel MPX is enabled. If 16-bit addressing is used.

### Compatibility Mode Exceptions

Same exceptions as in protected mode.

### 64-Bit Mode Exceptions

#UD	If ModRM.r/m and REX encodes BND4-BND15 when Intel MPX is enabled.
-----	--

Same exceptions as in protected mode.

**BNDUCU/BNDNCN—Check Upper Bound**

Opcode/ Instruction	Op/En	64/32 bit Mode Support	CPUID Feature Flag	Description
F2 0F 1A /r BNDUCU bnd, r/m32	RM	NE/V	MPX	Generate a #BR if the address in r/m32 is higher than the upper bound in bnd.UB (bnb.UB in 1's complement form).
F2 0F 1A /r BNDUCU bnd, r/m64	RM	V/NE	MPX	Generate a #BR if the address in r/m64 is higher than the upper bound in bnd.UB (bnb.UB in 1's complement form).
F2 0F 1B /r BNDNCN bnd, r/m32	RM	NE/V	MPX	Generate a #BR if the address in r/m32 is higher than the upper bound in bnd.UB (bnb.UB not in 1's complement form).
F2 0F 1B /r BNDNCN bnd, r/m64	RM	V/NE	MPX	Generate a #BR if the address in r/m64 is higher than the upper bound in bnd.UB (bnb.UB not in 1's complement form).

**Instruction Operand Encoding**

Op/En	Operand 1	Operand 2	Operand 3
RM	ModRM:reg (w)	ModRM:r/m (r)	NA

**Description**

Compare the address in the second operand with the upper bound in bnd. The second operand can be either a register or a memory operand. If the address is higher than the upper bound in bnd.UB, it will set BNDSTATUS to 01H and signal a #BR exception.

BNDUCU perform 1's complement operation on the upper bound of bnd first before proceeding with address comparison. BNDNCN perform address comparison directly using the upper bound in bnd that is already reverted out of 1's complement form.

This instruction does not cause any memory access, and does not read or write any flags.

Effective address computation of m32/64 has identical behavior to LEA

**Operation****BNDUCU BND, reg**

```
IF reg > NOT(BND.UB) Then
    BNDSTATUS ← 01H;
    #BR;
FI;
```

**BNDUCU BND, mem**

```
TEMP ← LEA(mem);
IF TEMP > NOT(BND.UB) Then
    BNDSTATUS ← 01H;
    #BR;
FI;
```

**BNDNCN BND, reg**

```
IF reg > BND.UB Then
    BNDSTATUS ← 01H;
    #BR;
FI;
```

```

BND CN BND, mem
TEMP ← LEA(mem);
IF TEMP > BND.UB Then
    BNDSTATUS ← 01H;
    #BR;
FI;

```

### Intel C/C++ Compiler Intrinsic Equivalent

```
BND CU .void _bnd_chk_ptr_ubounds(const void *q)
```

### Flags Affected

None

### Protected Mode Exceptions

#BR	If upper bound check fails.
#UD	If the LOCK prefix is used. If ModRM.r/m encodes BND4-BND7 when Intel MPX is enabled. If 67H prefix is not used and CS.D=0. If 67H prefix is used and CS.D=1.

### Real-Address Mode Exceptions

#BR	If upper bound check fails.
#UD	If the LOCK prefix is used. If ModRM.r/m encodes BND4-BND7 when Intel MPX is enabled. If 16-bit addressing is used.

### Virtual-8086 Mode Exceptions

#BR	If upper bound check fails.
#UD	If the LOCK prefix is used. If ModRM.r/m encodes BND4-BND7 when Intel MPX is enabled. If 16-bit addressing is used.

### Compatibility Mode Exceptions

Same exceptions as in protected mode.

### 64-Bit Mode Exceptions

#UD	If ModRM.r/m and REX encodes BND4-BND15 when Intel MPX is enabled.
-----	--

Same exceptions as in protected mode.

**BNDLDX—Load Extended Bounds Using Address Translation**

Opcode/ Instruction	Op/En	64/32 bit Mode Support	CPUID Feature Flag	Description
NP OF 1A /r BNDLDX bnd, mib	RM	V/V	MPX	Load the bounds stored in a bound table entry (BTE) into bnd with address translation using the base of mib and conditional on the index of mib matching the pointer value in the BTE.

**Instruction Operand Encoding**

Op/En	Operand 1	Operand 2	Operand 3
RM	ModRM:reg (w)	SIB.base (r): Address of pointer SIB.index(r)	NA

**Description**

BNDLDX uses the linear address constructed from the base register and displacement of the SIB-addressing form of the memory operand (mib) to perform address translation to access a bound table entry and conditionally load the bounds in the BTE to the destination. The destination register is updated with the bounds in the BTE, if the content of the index register of mib matches the pointer value stored in the BTE.

If the pointer value comparison fails, the destination is updated with INIT bounds (lb = 0x0, ub = 0x0) (note: as articulated earlier, the upper bound is represented using 1's complement, therefore, the 0x0 value of upper bound allows for access to full memory).

This instruction does not cause memory access to the linear address of mib nor the effective address referenced by the base, and does not read or write any flags.

Segment overrides apply to the linear address computation with the base of mib, and are used during address translation to generate the address of the bound table entry. By default, the address of the BTE is assumed to be linear address. There are no segmentation checks performed on the base of mib.

The base of mib will not be checked for canonical address violation as it does not access memory.

Any encoding of this instruction that does not specify base or index register will treat those registers as zero (constant). The reg-reg form of this instruction will remain a NOP.

The scale field of the SIB byte has no effect on these instructions and is ignored.

The bound register may be partially updated on memory faults. The order in which memory operands are loaded is implementation specific.

**Operation**

```
base ← mib.SIB.base ? mib.SIB.base + Disp : 0;
ptr_value ← mib.SIB.index ? mib.SIB.index : 0;
```

**Outside 64-bit mode**

```
A_BDE[31:0] ← (Zero_extend32(base[31:12] << 2) + (BNDCFG[31:12] << 12));
```

```
A_BT[31:0] ← LoadFrom(A_BDE);
```

```
IF A_BT[0] equal 0 Then
```

```
    BNDSTATUS ← A_BDE | 02H;
```

```
    #BR;
```

```
FI;
```

```
A_BTE[31:0] ← (Zero_extend32(base[11:2] << 4) + (A_BT[31:2] << 2));
```

```
Temp_lb[31:0] ← LoadFrom(A_BTE);
```

```
Temp_ub[31:0] ← LoadFrom(A_BTE + 4);
```

```
Temp_ptr[31:0] ← LoadFrom(A_BTE + 8);
```

```
IF Temp_ptr equal ptr_value Then
```

```
    BND.LB ← Temp_lb;
```

```
    BND.UB ← Temp_ub;
```

```
ELSE
    BND.LB ← 0;
    BND.UB ← 0;
FI;
```

#### In 64-bit mode

```
A_BDE[63:0] ← (Zero_extend64(base[47+MAWA:20] << 3) + (BNDCFG[63:12] << 12));1
A_BT[63:0] ← LoadFrom(A_BDE);
IF A_BT[0] equal 0 Then
    BNDSTATUS ← A_BDE | 02H;
    #BR;
FI;
A_BTE[63:0] ← (Zero_extend64(base[19:3] << 5) + (A_BT[63:3] << 3));
Temp_lb[63:0] ← LoadFrom(A_BTE);
Temp_ub[63:0] ← LoadFrom(A_BTE + 8);
Temp_ptr[63:0] ← LoadFrom(A_BTE + 16);
IF Temp_ptr equal ptr_value Then
    BND.LB ← Temp_lb;
    BND.UB ← Temp_ub;
ELSE
    BND.LB ← 0;
    BND.UB ← 0;
FI;
```

#### Intel C/C++ Compiler Intrinsic Equivalent

BNDLDX: Generated by compiler as needed.

#### Flags Affected

None

#### Protected Mode Exceptions

#BR	If the bound directory entry is invalid.
#UD	If the LOCK prefix is used. If ModRM.r/m encodes BND4-BND7 when Intel MPX is enabled. If 67H prefix is not used and CS.D=0. If 67H prefix is used and CS.D=1.
#GP(0)	If a destination effective address of the Bound Table entry is outside the DS segment limit. If DS register contains a NULL segment selector.
#PF(fault code)	If a page fault occurs.

#### Real-Address Mode Exceptions

#UD	If the LOCK prefix is used. If ModRM.r/m encodes BND4-BND7 when Intel MPX is enabled. If 16-bit addressing is used.
#GP(0)	If a destination effective address of the Bound Table entry is outside the DS segment limit.

1. If CPL < 3, the supervisor MAWA (MAWAS) is used; this value is 0. If CPL = 3, the user MAWA (MAWAU) is used; this value is enumerated in CPUID.(EAX=07H,ECX=0H):ECX.MAWAU[bits 21:17]. See Section 17.3.1 of *Intel® 64 and IA-32 Architectures Software Developer's Manual, Volume 1*.

### Virtual-8086 Mode Exceptions

- #UD                    If the LOCK prefix is used.  
                         If ModRM.r/m encodes BND4-BND7 when Intel MPX is enabled.  
                         If 16-bit addressing is used.
- #GP(0)                If a destination effective address of the Bound Table entry is outside the DS segment limit.
- #PF(fault code)      If a page fault occurs.

### Compatibility Mode Exceptions

Same exceptions as in protected mode.

### 64-Bit Mode Exceptions

- #BR                    If the bound directory entry is invalid.
- #UD                    If ModRM is RIP relative.  
                         If the LOCK prefix is used.  
                         If ModRM.r/m and REX encodes BND4-BND15 when Intel MPX is enabled.
- #GP(0)                If the memory address (A\_BDE or A\_BTE) is in a non-canonical form.
- #PF(fault code)      If a page fault occurs.



## BNDMK—Make Bounds

Opcode/ Instruction	Op/En	64/32 bit Mode Support	CPUID Feature Flag	Description
F3 0F 1B /r BNDMK bnd, m32	RM	NE/V	MPX	Make lower and upper bounds from m32 and store them in bnd.
F3 0F 1B /r BNDMK bnd, m64	RM	V/NE	MPX	Make lower and upper bounds from m64 and store them in bnd.

### Instruction Operand Encoding

Op/En	Operand 1	Operand 2	Operand 3
RM	ModRM:reg (w)	ModRM:r/m (r)	NA

### Description

Makes bounds from the second operand and stores the lower and upper bounds in the bound register bnd. The second operand must be a memory operand. The content of the base register from the memory operand is stored in the lower bound bnd.LB. The 1's complement of the effective address of m32/m64 is stored in the upper bound b.UB. Computation of m32/m64 has identical behavior to LEA.

This instruction does not cause any memory access, and does not read or write any flags.

If the instruction did not specify base register, the lower bound will be zero. The reg-reg form of this instruction retains legacy behavior (NOP).

The instruction causes an invalid-opcode exception (#UD) if executed in 64-bit mode with RIP-relative addressing.

### Operation

BND.LB ← SRCMEM.base;

IF 64-bit mode Then

BND.UB ← NOT(LEA.64\_bits(SRCMEM));

ELSE

BND.UB ← Zero\_Extend.64\_bits(NOT(LEA.32\_bits(SRCMEM)));

FI;

### Intel C/C++ Compiler Intrinsic Equivalent

```
BNDMKvoid * _bnd_set_ptr_bounds(const void * q, size_t size);
```

### Flags Affected

None

### Protected Mode Exceptions

#UD

- If the LOCK prefix is used.
- If ModRM.r/m encodes BND4-BND7 when Intel MPX is enabled.
- If 67H prefix is not used and CS.D=0.
- If 67H prefix is used and CS.D=1.

### Real-Address Mode Exceptions

#UD

- If the LOCK prefix is used.
- If ModRM.r/m encodes BND4-BND7 when Intel MPX is enabled.
- If 16-bit addressing is used.

### Virtual-8086 Mode Exceptions

- #UD If the LOCK prefix is used.  
If ModRM.r/m encodes BND4-BND7 when Intel MPX is enabled.  
If 16-bit addressing is used.

### Compatibility Mode Exceptions

Same exceptions as in protected mode.

### 64-Bit Mode Exceptions

- #UD If the LOCK prefix is used.  
If ModRM.r/m and REX encodes BND4-BND15 when Intel MPX is enabled.  
If RIP-relative addressing is used.
- #SS(0) If the memory address referencing the SS segment is in a non-canonical form.
- #GP(0) If the memory address is in a non-canonical form.

Same exceptions as in protected mode.

## BNDMOV—Move Bounds

Opcode/ Instruction	Op/En	64/32 bit Mode Support	CPUID Feature Flag	Description
66 0F 1A /r BNDMOV bnd1, bnd2/m64	RM	NE/V	MPX	Move lower and upper bound from bnd2/m64 to bound register bnd1.
66 0F 1A /r BNDMOV bnd1, bnd2/m128	RM	V/NE	MPX	Move lower and upper bound from bnd2/m128 to bound register bnd1.
66 0F 1B /r BNDMOV bnd1/m64, bnd2	MR	NE/V	MPX	Move lower and upper bound from bnd2 to bnd1/m64.
66 0F 1B /r BNDMOV bnd1/m128, bnd2	MR	V/NE	MPX	Move lower and upper bound from bnd2 to bound register bnd1/m128.

### Instruction Operand Encoding

Op/En	Operand 1	Operand 2	Operand 3
RM	ModRM:reg (w)	ModRM:r/m (r)	NA
MR	ModRM:r/m (w)	ModRM:reg (r)	NA

### Description

BNDMOV moves a pair of lower and upper bound values from the source operand (the second operand) to the destination (the first operand). Each operation is 128-bit move. The exceptions are the same as the MOV instruction. The memory format for loading/store bounds in 64-bit mode is shown in Figure 3-5.

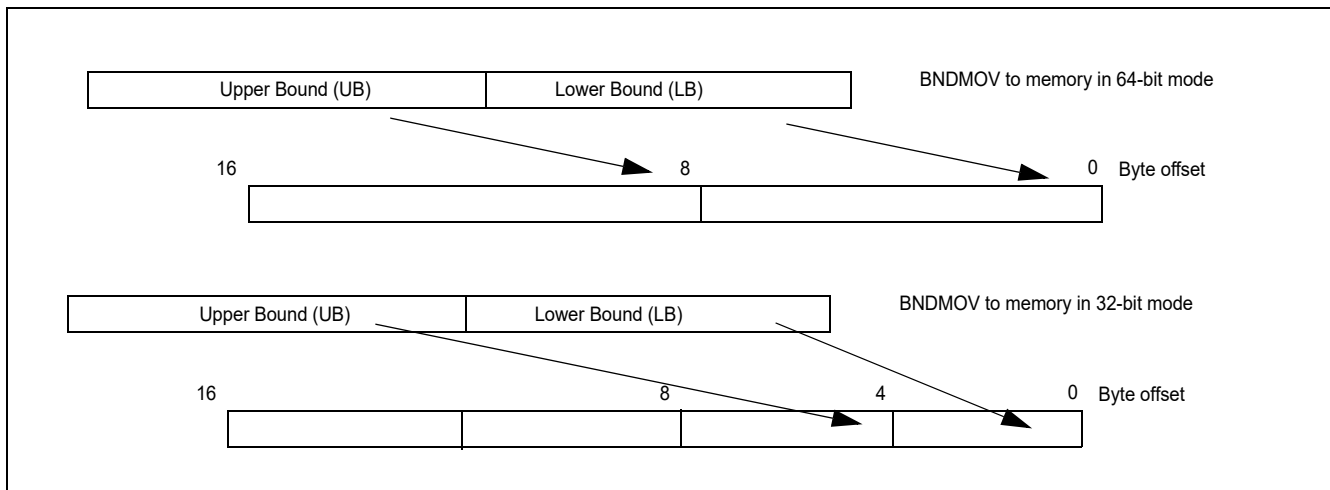

Figure 3-5. Memory Layout of BNDMOV to/from Memory

This instruction does not change flags.

### Operation

#### BNDMOV register to register

DEST.LB ← SRC.LB;  
DEST.UB ← SRC.UB;

**BNDMOV from memory**

```

IF 64-bit mode THEN
    DEST.LB ← LOAD_QWORD(SRC);
    DEST.UB ← LOAD_QWORD(SRC+8);
ELSE
    DEST.LB ← LOAD_DWORD_ZERO_EXT(SRC);
    DEST.UB ← LOAD_DWORD_ZERO_EXT(SRC+4);
FI;

```

**BNDMOV to memory**

```

IF 64-bit mode THEN
    DEST[63:0] ← SRC.LB;
    DEST[127:64] ← SRC.UB;
ELSE
    DEST[31:0] ← SRC.LB;
    DEST[63:32] ← SRC.UB;
FI;

```

**Intel C/C++ Compiler Intrinsic Equivalent**

```
BNDMOV    void * _bnd_copy_ptr_bounds(const void *q, const void *r)
```

**Flags Affected**

None

**Protected Mode Exceptions**

#UD	If the LOCK prefix is used but the destination is not a memory operand. If ModRM.r/m encodes BND4-BND7 when Intel MPX is enabled. If 67H prefix is not used and CS.D=0. If 67H prefix is used and CS.D=1.
#SS(0)	If the memory operand effective address is outside the SS segment limit.
#GP(0)	If the memory operand effective address is outside the CS, DS, ES, FS, or GS segment limit. If the destination operand points to a non-writable segment If the DS, ES, FS, or GS segment register contains a NULL segment selector.
#AC(0)	If alignment checking is enabled and an unaligned memory reference is made while CPL is 3.
#PF(fault code)	If a page fault occurs.

**Real-Address Mode Exceptions**

#UD	If the LOCK prefix is used but the destination is not a memory operand. If ModRM.r/m encodes BND4-BND7 when Intel MPX is enabled. If 16-bit addressing is used.
#GP(0)	If the memory operand effective address is outside the CS, DS, ES, FS, or GS segment limit.
#SS	If the memory operand effective address is outside the SS segment limit.

**Virtual-8086 Mode Exceptions**

#UD	If the LOCK prefix is used but the destination is not a memory operand. If ModRM.r/m encodes BND4-BND7 when Intel MPX is enabled. If 16-bit addressing is used.
#GP(0)	If the memory operand effective address is outside the CS, DS, ES, FS, or GS segment limit.
#SS(0)	If the memory operand effective address is outside the SS segment limit.
#AC(0)	If alignment checking is enabled and an unaligned memory reference is made while CPL is 3.
#PF(fault code)	If a page fault occurs.

**Compatibility Mode Exceptions**

Same exceptions as in protected mode.

**64-Bit Mode Exceptions**

#UD	If the LOCK prefix is used but the destination is not a memory operand. If ModRM.r/m and REX encodes BND4-BND15 when Intel MPX is enabled.
#SS(0)	If the memory address referencing the SS segment is in a non-canonical form.
#GP(0)	If the memory address is in a non-canonical form.
#AC(0)	If alignment checking is enabled and an unaligned memory reference is made while CPL is 3.
#PF(fault code)	If a page fault occurs.

## BNDSTX—Store Extended Bounds Using Address Translation

Opcode/ Instruction	Op/En	64/32 bit Mode Support	CPUID Feature Flag	Description
NP OF 1B /r BNDSTX mib, bnd	MR	V/V	MPX	Store the bounds in bnd and the pointer value in the index register of mib to a bound table entry (BTE) with address translation using the base of mib.

### Instruction Operand Encoding

Op/En	Operand 1	Operand 2	Operand 3
MR	SIB.base (r): Address of pointer SIB.index(r)	ModRM:reg (r)	NA

### Description

BNDSTX uses the linear address constructed from the displacement and base register of the SIB-addressing form of the memory operand (mib) to perform address translation to store to a bound table entry. The bounds in the source operand bnd are written to the lower and upper bounds in the BTE. The content of the index register of mib is written to the pointer value field in the BTE.

This instruction does not cause memory access to the linear address of mib nor the effective address referenced by the base, and does not read or write any flags.

Segment overrides apply to the linear address computation with the base of mib, and are used during address translation to generate the address of the bound table entry. By default, the address of the BTE is assumed to be linear address. There are no segmentation checks performed on the base of mib.

The base of mib will not be checked for canonical address violation as it does not access memory.

Any encoding of this instruction that does not specify base or index register will treat those registers as zero (constant). The reg-reg form of this instruction will remain a NOP.

The scale field of the SIB byte has no effect on these instructions and is ignored.

The bound register may be partially updated on memory faults. The order in which memory operands are loaded is implementation specific.

### Operation

```
base ← mib.SIB.base ? mib.SIB.base + Disp: 0;
ptr_value ← mib.SIB.index ? mib.SIB.index : 0;
```

### Outside 64-bit mode

```
A_BDE[31:0] ← (Zero_extend32(base[31:12] << 2) + (BNDCFG[31:12] << 12));
A_BT[31:0] ← LoadFrom(A_BDE);
IF A_BT[0] equal 0 Then
    BNDSTATUS ← A_BDE | 02H;
    #BR;
FI;
A_DEST[31:0] ← (Zero_extend32(base[11:2] << 4) + (A_BT[31:2] << 2)); // address of Bound table entry
A_DEST[8][31:0] ← ptr_value;
A_DEST[0][31:0] ← BND.LB;
A_DEST[4][31:0] ← BND.UB;
```

**In 64-bit mode**

```

A_BDE[63:0] ← (Zero_extend64(base[47+MAWA:20] << 3) + (BNDCFG[63:12] << 12));1
A_BT[63:0] ← LoadFrom(A_BDE);
IF A_BT[0] equal 0 Then
    BNDSTATUS ← A_BDE | 02H;
    #BR;
FI;
A_DEST[63:0] ← (Zero_extend64(base[19:3] << 5) + (A_BT[63:3] << 3)); // address of Bound table entry
A_DEST[16][63:0] ← ptr_value;
A_DEST[0][63:0] ← BND.LB;
A_DEST[8][63:0] ← BND.UB;

```

**Intel C/C++ Compiler Intrinsic Equivalent**

```
BNDSTX: _bnd_store_ptr_bounds(const void **ptr_addr, const void *ptr_val);
```

**Flags Affected**

None

**Protected Mode Exceptions**

#BR	If the bound directory entry is invalid.
#UD	If the LOCK prefix is used. If ModRM.r/m encodes BND4-BND7 when Intel MPX is enabled. If 67H prefix is not used and CS.D=0. If 67H prefix is used and CS.D=1.
#GP(0)	If a destination effective address of the Bound Table entry is outside the DS segment limit. If DS register contains a NULL segment selector. If the destination operand points to a non-writable segment
#PF(fault code)	If a page fault occurs.

**Real-Address Mode Exceptions**

#UD	If the LOCK prefix is used. If ModRM.r/m encodes BND4-BND7 when Intel MPX is enabled. If 16-bit addressing is used.
#GP(0)	If a destination effective address of the Bound Table entry is outside the DS segment limit.

**Virtual-8086 Mode Exceptions**

#UD	If the LOCK prefix is used. If ModRM.r/m encodes BND4-BND7 when Intel MPX is enabled. If 16-bit addressing is used.
#GP(0)	If a destination effective address of the Bound Table entry is outside the DS segment limit.
#PF(fault code)	If a page fault occurs.

**Compatibility Mode Exceptions**

Same exceptions as in protected mode.

---

1. If CPL < 3, the supervisor MAWA (MAWAS) is used; this value is 0. If CPL = 3, the user MAWA (MAWAU) is used; this value is enumerated in CPUID.(EAX=07H,ECX=0H):ECX.MAWAU[bits 21:17]. See Section 17.3.1 of *Intel® 64 and IA-32 Architectures Software Developer's Manual, Volume 1*.

### 64-Bit Mode Exceptions

#BR	If the bound directory entry is invalid.
#UD	If ModRM is RIP relative. If the LOCK prefix is used. If ModRM.r/m and REX encodes BND4-BND15 when Intel MPX is enabled.
#GP(0)	If the memory address (A_BDE or A_BTE) is in a non-canonical form. If the destination operand points to a non-writable segment
#PF(fault code)	If a page fault occurs.



## BOUND—Check Array Index Against Bounds

Opcode	Instruction	Op/En	64-bit Mode	Compat/Leg Mode	Description
62 /r	BOUND <i>r16, m16&amp;16</i>	RM	Invalid	Valid	Check if <i>r16</i> (array index) is within bounds specified by <i>m16&amp;16</i> .
62 /r	BOUND <i>r32, m32&amp;32</i>	RM	Invalid	Valid	Check if <i>r32</i> (array index) is within bounds specified by <i>m32&amp;32</i> .

### Instruction Operand Encoding

Op/En	Operand 1	Operand 2	Operand 3	Operand 4
RM	ModRM:reg (r)	ModRM:r/m (r)	NA	NA

### Description

BOUND determines if the first operand (array index) is within the bounds of an array specified the second operand (bounds operand). The array index is a signed integer located in a register. The bounds operand is a memory location that contains a pair of signed doubleword-integers (when the operand-size attribute is 32) or a pair of signed word-integers (when the operand-size attribute is 16). The first doubleword (or word) is the lower bound of the array and the second doubleword (or word) is the upper bound of the array. The array index must be greater than or equal to the lower bound and less than or equal to the upper bound plus the operand size in bytes. If the index is not within bounds, a BOUND range exceeded exception (#BR) is signaled. When this exception is generated, the saved return instruction pointer points to the BOUND instruction.

The bounds limit data structure (two words or doublewords containing the lower and upper limits of the array) is usually placed just before the array itself, making the limits addressable via a constant offset from the beginning of the array. Because the address of the array already will be present in a register, this practice avoids extra bus cycles to obtain the effective address of the array bounds.

This instruction executes as described in compatibility mode and legacy mode. It is not valid in 64-bit mode.

### Operation

```
IF 64bit Mode
  THEN
    #UD;
  ELSE
    IF (ArrayIndex < LowerBound OR ArrayIndex > UpperBound) THEN
      (* Below lower bound or above upper bound *)
      IF <equation for PL enabled> THEN BNDSTATUS ← 0
      #BR;
    FI;
  FI;
```

### Flags Affected

None.

**Protected Mode Exceptions**

#BR	If the bounds test fails.
#UD	If second operand is not a memory location. If the LOCK prefix is used.
#GP(0)	If a memory operand effective address is outside the CS, DS, ES, FS, or GS segment limit. If the DS, ES, FS, or GS register contains a NULL segment selector.
#SS(0)	If a memory operand effective address is outside the SS segment limit.
#PF(fault-code)	If a page fault occurs.
#AC(0)	If alignment checking is enabled and an unaligned memory reference is made while the current privilege level is 3.

**Real-Address Mode Exceptions**

#BR	If the bounds test fails.
#UD	If second operand is not a memory location. If the LOCK prefix is used.
#GP	If a memory operand effective address is outside the CS, DS, ES, FS, or GS segment limit.
#SS	If a memory operand effective address is outside the SS segment limit.

**Virtual-8086 Mode Exceptions**

#BR	If the bounds test fails.
#UD	If second operand is not a memory location. If the LOCK prefix is used.
#GP(0)	If a memory operand effective address is outside the CS, DS, ES, FS, or GS segment limit.
#SS(0)	If a memory operand effective address is outside the SS segment limit.
#PF(fault-code)	If a page fault occurs.
#AC(0)	If alignment checking is enabled and an unaligned memory reference is made.

**Compatibility Mode Exceptions**

Same exceptions as in protected mode.

**64-Bit Mode Exceptions**

#UD	If in 64-bit mode.
-----	--------------------

## BSF—Bit Scan Forward

Opcode	Instruction	Op/En	64-bit Mode	Compat/Leg Mode	Description
OF BC /r	BSF <i>r16, r/m16</i>	RM	Valid	Valid	Bit scan forward on <i>r/m16</i> .
OF BC /r	BSF <i>r32, r/m32</i>	RM	Valid	Valid	Bit scan forward on <i>r/m32</i> .
REX.W + OF BC /r	BSF <i>r64, r/m64</i>	RM	Valid	N.E.	Bit scan forward on <i>r/m64</i> .

### Instruction Operand Encoding

Op/En	Operand 1	Operand 2	Operand 3	Operand 4
RM	ModRM:reg (w)	ModRM:r/m (r)	NA	NA

### Description

Searches the source operand (second operand) for the least significant set bit (1 bit). If a least significant 1 bit is found, its bit index is stored in the destination operand (first operand). The source operand can be a register or a memory location; the destination operand is a register. The bit index is an unsigned offset from bit 0 of the source operand. If the content of the source operand is 0, the content of the destination operand is undefined.

In 64-bit mode, the instruction's default operation size is 32 bits. Using a REX prefix in the form of REX.R permits access to additional registers (R8-R15). Using a REX prefix in the form of REX.W promotes operation to 64 bits. See the summary chart at the beginning of this section for encoding data and limits.

### Operation

```

IF SRC = 0
  THEN
    ZF ← 1;
    DEST is undefined;
  ELSE
    ZF ← 0;
    temp ← 0;
    WHILE Bit(SRC, temp) = 0
      DO
        temp ← temp + 1;
      OD;
    DEST ← temp;
FI;

```

### Flags Affected

The ZF flag is set to 1 if the source operand is 0; otherwise, the ZF flag is cleared. The CF, OF, SF, AF, and PF flags are undefined.

### Protected Mode Exceptions

#GP(0)	If a memory operand effective address is outside the CS, DS, ES, FS, or GS segment limit. If the DS, ES, FS, or GS register contains a NULL segment selector.
#SS(0)	If a memory operand effective address is outside the SS segment limit.
#PF(fault-code)	If a page fault occurs.
#AC(0)	If alignment checking is enabled and an unaligned memory reference is made while the current privilege level is 3.
#UD	If the LOCK prefix is used.

### Real-Address Mode Exceptions

- #GP If a memory operand effective address is outside the CS, DS, ES, FS, or GS segment limit.
- #SS If a memory operand effective address is outside the SS segment limit.
- #UD If the LOCK prefix is used.

### Virtual-8086 Mode Exceptions

- #GP(0) If a memory operand effective address is outside the CS, DS, ES, FS, or GS segment limit.
- #SS(0) If a memory operand effective address is outside the SS segment limit.
- #PF(fault-code) If a page fault occurs.
- #AC(0) If alignment checking is enabled and an unaligned memory reference is made.
- #UD If the LOCK prefix is used.

### Compatibility Mode Exceptions

Same exceptions as in protected mode.

### 64-Bit Mode Exceptions

- #SS(0) If a memory address referencing the SS segment is in a non-canonical form.
- #GP(0) If the memory address is in a non-canonical form.
- #PF(fault-code) If a page fault occurs.
- #AC(0) If alignment checking is enabled and an unaligned memory reference is made while the current privilege level is 3.
- #UD If the LOCK prefix is used.

## BSR—Bit Scan Reverse

Opcode	Instruction	Op/En	64-bit Mode	Compat/Leg Mode	Description
OF BD /r	BSR <i>r16, r/m16</i>	RM	Valid	Valid	Bit scan reverse on <i>r/m16</i> .
OF BD /r	BSR <i>r32, r/m32</i>	RM	Valid	Valid	Bit scan reverse on <i>r/m32</i> .
REX.W + OF BD /r	BSR <i>r64, r/m64</i>	RM	Valid	N.E.	Bit scan reverse on <i>r/m64</i> .

### Instruction Operand Encoding

Op/En	Operand 1	Operand 2	Operand 3	Operand 4
RM	ModRM:reg ( <i>w</i> )	ModRM:r/m ( <i>r</i> )	NA	NA

### Description

Searches the source operand (second operand) for the most significant set bit (1 bit). If a most significant 1 bit is found, its bit index is stored in the destination operand (first operand). The source operand can be a register or a memory location; the destination operand is a register. The bit index is an unsigned offset from bit 0 of the source operand. If the content source operand is 0, the content of the destination operand is undefined.

In 64-bit mode, the instruction's default operation size is 32 bits. Using a REX prefix in the form of REX.R permits access to additional registers (R8-R15). Using a REX prefix in the form of REX.W promotes operation to 64 bits. See the summary chart at the beginning of this section for encoding data and limits.

### Operation

```

IF SRC = 0
  THEN
    ZF ← 1;
    DEST is undefined;
  ELSE
    ZF ← 0;
    temp ← OperandSize - 1;
    WHILE Bit(SRC, temp) = 0
      DO
        temp ← temp - 1;
      OD;
    DEST ← temp;
FI;

```

### Flags Affected

The ZF flag is set to 1 if the source operand is 0; otherwise, the ZF flag is cleared. The CF, OF, SF, AF, and PF flags are undefined.

### Protected Mode Exceptions

#GP(0)	If a memory operand effective address is outside the CS, DS, ES, FS, or GS segment limit. If the DS, ES, FS, or GS register contains a NULL segment selector.
#SS(0)	If a memory operand effective address is outside the SS segment limit.
#PF(fault-code)	If a page fault occurs.
#AC(0)	If alignment checking is enabled and an unaligned memory reference is made while the current privilege level is 3.
#UD	If the LOCK prefix is used.

### Real-Address Mode Exceptions

- #GP If a memory operand effective address is outside the CS, DS, ES, FS, or GS segment limit.
- #SS If a memory operand effective address is outside the SS segment limit.
- #UD If the LOCK prefix is used.

### Virtual-8086 Mode Exceptions

- #GP(0) If a memory operand effective address is outside the CS, DS, ES, FS, or GS segment limit.
- #SS(0) If a memory operand effective address is outside the SS segment limit.
- #PF(fault-code) If a page fault occurs.
- #AC(0) If alignment checking is enabled and an unaligned memory reference is made.
- #UD If the LOCK prefix is used.

### Compatibility Mode Exceptions

Same exceptions as in protected mode.

### 64-Bit Mode Exceptions

- #SS(0) If a memory address referencing the SS segment is in a non-canonical form.
- #GP(0) If the memory address is in a non-canonical form.
- #PF(fault-code) If a page fault occurs.
- #AC(0) If alignment checking is enabled and an unaligned memory reference is made while the current privilege level is 3.
- #UD If the LOCK prefix is used.

## BSWAP—Byte Swap

Opcode	Instruction	Op/En	64-bit Mode	Compat/Leg Mode	Description
OF C8+ <i>rd</i>	BSWAP <i>r32</i>	0	Valid*	Valid	Reverses the byte order of a 32-bit register.
REX.W + OF C8+ <i>rd</i>	BSWAP <i>r64</i>	0	Valid	N.E.	Reverses the byte order of a 64-bit register.

### NOTES:

\* See IA-32 Architecture Compatibility section below.

### Instruction Operand Encoding

Op/En	Operand 1	Operand 2	Operand 3	Operand 4
0	opcode + <i>rd</i> ( <i>r</i> , <i>w</i> )	NA	NA	NA

### Description

Reverses the byte order of a 32-bit or 64-bit (destination) register. This instruction is provided for converting little-endian values to big-endian format and vice versa. To swap bytes in a word value (16-bit register), use the XCHG instruction. When the BSWAP instruction references a 16-bit register, the result is undefined.

In 64-bit mode, the instruction's default operation size is 32 bits. Using a REX prefix in the form of REX.R permits access to additional registers (R8-R15). Using a REX prefix in the form of REX.W promotes operation to 64 bits. See the summary chart at the beginning of this section for encoding data and limits.

### IA-32 Architecture Legacy Compatibility

The BSWAP instruction is not supported on IA-32 processors earlier than the Intel486™ processor family. For compatibility with this instruction, software should include functionally equivalent code for execution on Intel processors earlier than the Intel486 processor family.

### Operation

TEMP ← DEST

IF 64-bit mode AND OperandSize = 64

THEN

DEST[7:0] ← TEMP[63:56];  
 DEST[15:8] ← TEMP[55:48];  
 DEST[23:16] ← TEMP[47:40];  
 DEST[31:24] ← TEMP[39:32];  
 DEST[39:32] ← TEMP[31:24];  
 DEST[47:40] ← TEMP[23:16];  
 DEST[55:48] ← TEMP[15:8];  
 DEST[63:56] ← TEMP[7:0];

ELSE

DEST[7:0] ← TEMP[31:24];  
 DEST[15:8] ← TEMP[23:16];  
 DEST[23:16] ← TEMP[15:8];  
 DEST[31:24] ← TEMP[7:0];

FI;

### Flags Affected

None.

### Exceptions (All Operating Modes)

#UD If the LOCK prefix is used.

## BT—Bit Test

Opcode	Instruction	Op/En	64-bit Mode	Compat/Leg Mode	Description
OF A3 /r	BT <i>r/m16, r16</i>	MR	Valid	Valid	Store selected bit in CF flag.
OF A3 /r	BT <i>r/m32, r32</i>	MR	Valid	Valid	Store selected bit in CF flag.
REX.W + OF A3 /r	BT <i>r/m64, r64</i>	MR	Valid	N.E.	Store selected bit in CF flag.
OF BA /4 <i>ib</i>	BT <i>r/m16, imm8</i>	MI	Valid	Valid	Store selected bit in CF flag.
OF BA /4 <i>ib</i>	BT <i>r/m32, imm8</i>	MI	Valid	Valid	Store selected bit in CF flag.
REX.W + OF BA /4 <i>ib</i>	BT <i>r/m64, imm8</i>	MI	Valid	N.E.	Store selected bit in CF flag.

### Instruction Operand Encoding

Op/En	Operand 1	Operand 2	Operand 3	Operand 4
MR	ModRM:r/m (r)	ModRM:reg (r)	NA	NA
MI	ModRM:r/m (r)	imm8	NA	NA

### Description

Selects the bit in a bit string (specified with the first operand, called the bit base) at the bit-position designated by the bit offset (specified by the second operand) and stores the value of the bit in the CF flag. The bit base operand can be a register or a memory location; the bit offset operand can be a register or an immediate value:

- If the bit base operand specifies a register, the instruction takes the modulo 16, 32, or 64 of the bit offset operand (modulo size depends on the mode and register size; 64-bit operands are available only in 64-bit mode).
- If the bit base operand specifies a memory location, the operand represents the address of the byte in memory that contains the bit base (bit 0 of the specified byte) of the bit string. The range of the bit position that can be referenced by the offset operand depends on the operand size.

See also: **Bit(BitBase, BitOffset)** on page 3-12.

Some assemblers support immediate bit offsets larger than 31 by using the immediate bit offset field in combination with the displacement field of the memory operand. In this case, the low-order 3 or 5 bits (3 for 16-bit operands, 5 for 32-bit operands) of the immediate bit offset are stored in the immediate bit offset field, and the high-order bits are shifted and combined with the byte displacement in the addressing mode by the assembler. The processor will ignore the high order bits if they are not zero.

When accessing a bit in memory, the processor may access 4 bytes starting from the memory address for a 32-bit operand size, using by the following relationship:

$$\text{Effective Address} + (4 * (\text{BitOffset} \text{ DIV } 32))$$

Or, it may access 2 bytes starting from the memory address for a 16-bit operand, using this relationship:

$$\text{Effective Address} + (2 * (\text{BitOffset} \text{ DIV } 16))$$

It may do so even when only a single byte needs to be accessed to reach the given bit. When using this bit addressing mechanism, software should avoid referencing areas of memory close to address space holes. In particular, it should avoid references to memory-mapped I/O registers. Instead, software should use the MOV instructions to load from or store to these addresses, and use the register form of these instructions to manipulate the data.

In 64-bit mode, the instruction's default operation size is 32 bits. Using a REX prefix in the form of REX.R permits access to additional registers (R8-R15). Using a REX prefix in the form of REX.W promotes operation to 64 bit operands. See the summary chart at the beginning of this section for encoding data and limits.

### Operation

CF ← Bit(BitBase, BitOffset);



## Flags Affected

The CF flag contains the value of the selected bit. The ZF flag is unaffected. The OF, SF, AF, and PF flags are undefined.

## Protected Mode Exceptions

#GP(0)	If a memory operand effective address is outside the CS, DS, ES, FS, or GS segment limit. If the DS, ES, FS, or GS register contains a NULL segment selector.
#SS(0)	If a memory operand effective address is outside the SS segment limit.
#PF(fault-code)	If a page fault occurs.
#AC(0)	If alignment checking is enabled and an unaligned memory reference is made while the current privilege level is 3.
#UD	If the LOCK prefix is used.

## Real-Address Mode Exceptions

#GP	If a memory operand effective address is outside the CS, DS, ES, FS, or GS segment limit.
#SS	If a memory operand effective address is outside the SS segment limit.
#UD	If the LOCK prefix is used.

## Virtual-8086 Mode Exceptions

#GP(0)	If a memory operand effective address is outside the CS, DS, ES, FS, or GS segment limit.
#SS(0)	If a memory operand effective address is outside the SS segment limit.
#PF(fault-code)	If a page fault occurs.
#AC(0)	If alignment checking is enabled and an unaligned memory reference is made.
#UD	If the LOCK prefix is used.

## Compatibility Mode Exceptions

Same exceptions as in protected mode.

## 64-Bit Mode Exceptions

#SS(0)	If a memory address referencing the SS segment is in a non-canonical form.
#GP(0)	If the memory address is in a non-canonical form.
#PF(fault-code)	If a page fault occurs.
#AC(0)	If alignment checking is enabled and an unaligned memory reference is made while the current privilege level is 3.
#UD	If the LOCK prefix is used.

## BTC—Bit Test and Complement

Opcode	Instruction	Op/En	64-bit Mode	Compat/Leg Mode	Description
OF BB /r	BTC <i>r/m16, r16</i>	MR	Valid	Valid	Store selected bit in CF flag and complement.
OF BB /r	BTC <i>r/m32, r32</i>	MR	Valid	Valid	Store selected bit in CF flag and complement.
REX.W + OF BB /r	BTC <i>r/m64, r64</i>	MR	Valid	N.E.	Store selected bit in CF flag and complement.
OF BA /7 <i>ib</i>	BTC <i>r/m16, imm8</i>	MI	Valid	Valid	Store selected bit in CF flag and complement.
OF BA /7 <i>ib</i>	BTC <i>r/m32, imm8</i>	MI	Valid	Valid	Store selected bit in CF flag and complement.
REX.W + OF BA /7 <i>ib</i>	BTC <i>r/m64, imm8</i>	MI	Valid	N.E.	Store selected bit in CF flag and complement.

### Instruction Operand Encoding

Op/En	Operand 1	Operand 2	Operand 3	Operand 4
MR	ModRM:r/m ( <i>r, w</i> )	ModRM:reg ( <i>r</i> )	NA	NA
MI	ModRM:r/m ( <i>r, w</i> )	imm8	NA	NA

### Description

Selects the bit in a bit string (specified with the first operand, called the bit base) at the bit-position designated by the bit offset operand (second operand), stores the value of the bit in the CF flag, and complements the selected bit in the bit string. The bit base operand can be a register or a memory location; the bit offset operand can be a register or an immediate value:

- If the bit base operand specifies a register, the instruction takes the modulo 16, 32, or 64 of the bit offset operand (modulo size depends on the mode and register size; 64-bit operands are available only in 64-bit mode). This allows any bit position to be selected.
- If the bit base operand specifies a memory location, the operand represents the address of the byte in memory that contains the bit base (bit 0 of the specified byte) of the bit string. The range of the bit position that can be referenced by the offset operand depends on the operand size.

See also: **Bit (BitBase, BitOffset)** on page 3-12.

Some assemblers support immediate bit offsets larger than 31 by using the immediate bit offset field in combination with the displacement field of the memory operand. See “BT—Bit Test” in this chapter for more information on this addressing mechanism.

This instruction can be used with a LOCK prefix to allow the instruction to be executed atomically.

In 64-bit mode, the instruction’s default operation size is 32 bits. Using a REX prefix in the form of REX.R permits access to additional registers (R8-R15). Using a REX prefix in the form of REX.W promotes operation to 64 bits. See the summary chart at the beginning of this section for encoding data and limits.

### Operation

CF ← Bit(BitBase, BitOffset);

Bit(BitBase, BitOffset) ← NOT Bit(BitBase, BitOffset);

### Flags Affected

The CF flag contains the value of the selected bit before it is complemented. The ZF flag is unaffected. The OF, SF, AF, and PF flags are undefined.

**Protected Mode Exceptions**

#GP(0)	If the destination operand points to a non-writable segment. If a memory operand effective address is outside the CS, DS, ES, FS, or GS segment limit. If the DS, ES, FS, or GS register contains a NULL segment selector.
#SS(0)	If a memory operand effective address is outside the SS segment limit.
#PF(fault-code)	If a page fault occurs.
#AC(0)	If alignment checking is enabled and an unaligned memory reference is made while the current privilege level is 3.
#UD	If the LOCK prefix is used but the destination is not a memory operand.

**Real-Address Mode Exceptions**

#GP	If a memory operand effective address is outside the CS, DS, ES, FS, or GS segment limit.
#SS	If a memory operand effective address is outside the SS segment limit.
#UD	If the LOCK prefix is used but the destination is not a memory operand.

**Virtual-8086 Mode Exceptions**

#GP(0)	If a memory operand effective address is outside the CS, DS, ES, FS, or GS segment limit.
#SS(0)	If a memory operand effective address is outside the SS segment limit.
#PF(fault-code)	If a page fault occurs.
#AC(0)	If alignment checking is enabled and an unaligned memory reference is made.
#UD	If the LOCK prefix is used but the destination is not a memory operand.

**Compatibility Mode Exceptions**

Same exceptions as in protected mode.

**64-Bit Mode Exceptions**

#SS(0)	If a memory address referencing the SS segment is in a non-canonical form.
#GP(0)	If the memory address is in a non-canonical form.
#PF(fault-code)	If a page fault occurs.
#AC(0)	If alignment checking is enabled and an unaligned memory reference is made while the current privilege level is 3.
#UD	If the LOCK prefix is used but the destination is not a memory operand.

## BTR—Bit Test and Reset

Opcode	Instruction	Op/En	64-bit Mode	Compat/Leg Mode	Description
OF B3 /r	BTR <i>r/m16, r16</i>	MR	Valid	Valid	Store selected bit in CF flag and clear.
OF B3 /r	BTR <i>r/m32, r32</i>	MR	Valid	Valid	Store selected bit in CF flag and clear.
REX.W + OF B3 /r	BTR <i>r/m64, r64</i>	MR	Valid	N.E.	Store selected bit in CF flag and clear.
OF BA /6 <i>ib</i>	BTR <i>r/m16, imm8</i>	MI	Valid	Valid	Store selected bit in CF flag and clear.
OF BA /6 <i>ib</i>	BTR <i>r/m32, imm8</i>	MI	Valid	Valid	Store selected bit in CF flag and clear.
REX.W + OF BA /6 <i>ib</i>	BTR <i>r/m64, imm8</i>	MI	Valid	N.E.	Store selected bit in CF flag and clear.

### Instruction Operand Encoding

Op/En	Operand 1	Operand 2	Operand 3	Operand 4
MR	ModRM:r/m ( <i>r, w</i> )	ModRM:reg ( <i>r</i> )	NA	NA
MI	ModRM:r/m ( <i>r, w</i> )	imm8	NA	NA

### Description

Selects the bit in a bit string (specified with the first operand, called the bit base) at the bit-position designated by the bit offset operand (second operand), stores the value of the bit in the CF flag, and clears the selected bit in the bit string to 0. The bit base operand can be a register or a memory location; the bit offset operand can be a register or an immediate value:

- If the bit base operand specifies a register, the instruction takes the modulo 16, 32, or 64 of the bit offset operand (modulo size depends on the mode and register size; 64-bit operands are available only in 64-bit mode). This allows any bit position to be selected.
- If the bit base operand specifies a memory location, the operand represents the address of the byte in memory that contains the bit base (bit 0 of the specified byte) of the bit string. The range of the bit position that can be referenced by the offset operand depends on the operand size.

See also: **Bit (BitBase, BitOffset)** on page 3-12.

Some assemblers support immediate bit offsets larger than 31 by using the immediate bit offset field in combination with the displacement field of the memory operand. See “BT—Bit Test” in this chapter for more information on this addressing mechanism.

This instruction can be used with a LOCK prefix to allow the instruction to be executed atomically.

In 64-bit mode, the instruction’s default operation size is 32 bits. Using a REX prefix in the form of REX.R permits access to additional registers (R8-R15). Using a REX prefix in the form of REX.W promotes operation to 64 bits. See the summary chart at the beginning of this section for encoding data and limits.

### Operation

CF ← Bit(BitBase, BitOffset);  
Bit(BitBase, BitOffset) ← 0;

### Flags Affected

The CF flag contains the value of the selected bit before it is cleared. The ZF flag is unaffected. The OF, SF, AF, and PF flags are undefined.

**Protected Mode Exceptions**

#GP(0)	If the destination operand points to a non-writable segment. If a memory operand effective address is outside the CS, DS, ES, FS, or GS segment limit. If the DS, ES, FS, or GS register contains a NULL segment selector.
#SS(0)	If a memory operand effective address is outside the SS segment limit.
#PF(fault-code)	If a page fault occurs.
#AC(0)	If alignment checking is enabled and an unaligned memory reference is made while the current privilege level is 3.
#UD	If the LOCK prefix is used but the destination is not a memory operand.

**Real-Address Mode Exceptions**

#GP	If a memory operand effective address is outside the CS, DS, ES, FS, or GS segment limit.
#SS	If a memory operand effective address is outside the SS segment limit.
#UD	If the LOCK prefix is used but the destination is not a memory operand.

**Virtual-8086 Mode Exceptions**

#GP(0)	If a memory operand effective address is outside the CS, DS, ES, FS, or GS segment limit.
#SS(0)	If a memory operand effective address is outside the SS segment limit.
#PF(fault-code)	If a page fault occurs.
#AC(0)	If alignment checking is enabled and an unaligned memory reference is made.
#UD	If the LOCK prefix is used but the destination is not a memory operand.

**Compatibility Mode Exceptions**

Same exceptions as in protected mode.

**64-Bit Mode Exceptions**

#SS(0)	If a memory address referencing the SS segment is in a non-canonical form.
#GP(0)	If the memory address is in a non-canonical form.
#PF(fault-code)	If a page fault occurs.
#AC(0)	If alignment checking is enabled and an unaligned memory reference is made while the current privilege level is 3.
#UD	If the LOCK prefix is used but the destination is not a memory operand.

## BTS—Bit Test and Set

Opcode	Instruction	Op/En	64-bit Mode	Compat/Leg Mode	Description
OF AB /r	BTS <i>r/m16, r16</i>	MR	Valid	Valid	Store selected bit in CF flag and set.
OF AB /r	BTS <i>r/m32, r32</i>	MR	Valid	Valid	Store selected bit in CF flag and set.
REX.W + OF AB /r	BTS <i>r/m64, r64</i>	MR	Valid	N.E.	Store selected bit in CF flag and set.
OF BA /5 <i>ib</i>	BTS <i>r/m16, imm8</i>	MI	Valid	Valid	Store selected bit in CF flag and set.
OF BA /5 <i>ib</i>	BTS <i>r/m32, imm8</i>	MI	Valid	Valid	Store selected bit in CF flag and set.
REX.W + OF BA /5 <i>ib</i>	BTS <i>r/m64, imm8</i>	MI	Valid	N.E.	Store selected bit in CF flag and set.

### Instruction Operand Encoding

Op/En	Operand 1	Operand 2	Operand 3	Operand 4
MR	ModRM:r/m ( <i>r, w</i> )	ModRM:reg ( <i>r</i> )	NA	NA
MI	ModRM:r/m ( <i>r, w</i> )	<i>imm8</i>	NA	NA

### Description

Selects the bit in a bit string (specified with the first operand, called the bit base) at the bit-position designated by the bit offset operand (second operand), stores the value of the bit in the CF flag, and sets the selected bit in the bit string to 1. The bit base operand can be a register or a memory location; the bit offset operand can be a register or an immediate value:

- If the bit base operand specifies a register, the instruction takes the modulo 16, 32, or 64 of the bit offset operand (modulo size depends on the mode and register size; 64-bit operands are available only in 64-bit mode). This allows any bit position to be selected.
- If the bit base operand specifies a memory location, the operand represents the address of the byte in memory that contains the bit base (bit 0 of the specified byte) of the bit string. The range of the bit position that can be referenced by the offset operand depends on the operand size.

See also: **Bit (BitBase, BitOffset)** on page 3-12.

Some assemblers support immediate bit offsets larger than 31 by using the immediate bit offset field in combination with the displacement field of the memory operand. See “BT—Bit Test” in this chapter for more information on this addressing mechanism.

This instruction can be used with a LOCK prefix to allow the instruction to be executed atomically.

In 64-bit mode, the instruction’s default operation size is 32 bits. Using a REX prefix in the form of REX.R permits access to additional registers (R8-R15). Using a REX prefix in the form of REX.W promotes operation to 64 bits. See the summary chart at the beginning of this section for encoding data and limits.

### Operation

CF ← Bit(BitBase, BitOffset);  
Bit(BitBase, BitOffset) ← 1;

### Flags Affected

The CF flag contains the value of the selected bit before it is set. The ZF flag is unaffected. The OF, SF, AF, and PF flags are undefined.

**Protected Mode Exceptions**

#GP(0)	If the destination operand points to a non-writable segment. If a memory operand effective address is outside the CS, DS, ES, FS, or GS segment limit. If the DS, ES, FS, or GS register contains a NULL segment selector.
#SS(0)	If a memory operand effective address is outside the SS segment limit.
#PF(fault-code)	If a page fault occurs.
#AC(0)	If alignment checking is enabled and an unaligned memory reference is made while the current privilege level is 3.
#UD	If the LOCK prefix is used but the destination is not a memory operand.

**Real-Address Mode Exceptions**

#GP	If a memory operand effective address is outside the CS, DS, ES, FS, or GS segment limit.
#SS	If a memory operand effective address is outside the SS segment limit.
#UD	If the LOCK prefix is used but the destination is not a memory operand.

**Virtual-8086 Mode Exceptions**

#GP	If a memory operand effective address is outside the CS, DS, ES, FS, or GS segment limit.
#SS	If a memory operand effective address is outside the SS segment limit.
#PF(fault-code)	If a page fault occurs.
#AC(0)	If alignment checking is enabled and an unaligned memory reference is made.
#UD	If the LOCK prefix is used but the destination is not a memory operand.

**Compatibility Mode Exceptions**

Same exceptions as in protected mode.

**64-Bit Mode Exceptions**

#SS(0)	If a memory address referencing the SS segment is in a non-canonical form.
#GP(0)	If the memory address is in a non-canonical form.
#PF(fault-code)	If a page fault occurs.
#AC(0)	If alignment checking is enabled and an unaligned memory reference is made while the current privilege level is 3.
#UD	If the LOCK prefix is used but the destination is not a memory operand.

**BZHI – Zero High Bits Starting with Specified Bit Position**

Opcode/Instruction	Op/En	64/32-bit Mode	CPUID Feature Flag	Description
VEX.NDS.LZ.0F38.W0 F5 /r BZHI r32a, r/m32, r32b	RMV	V/V	BMI2	Zero bits in r/m32 starting with the position in r32b, write result to r32a.
VEX.NDS.LZ.0F38.W1 F5 /r BZHI r64a, r/m64, r64b	RMV	V/N.E.	BMI2	Zero bits in r/m64 starting with the position in r64b, write result to r64a.

**Instruction Operand Encoding**

Op/En	Operand 1	Operand 2	Operand 3	Operand 4
RMV	ModRM:reg (w)	ModRM:r/m (r)	VEX.vvvv (r)	NA

**Description**

BZHI copies the bits of the first source operand (the second operand) into the destination operand (the first operand) and clears the higher bits in the destination according to the INDEX value specified by the second source operand (the third operand). The INDEX is specified by bits 7:0 of the second source operand. The INDEX value is saturated at the value of OperandSize - 1. CF is set, if the number contained in the 8 low bits of the third operand is greater than OperandSize - 1.

This instruction is not supported in real mode and virtual-8086 mode. The operand size is always 32 bits if not in 64-bit mode. In 64-bit mode operand size 64 requires VEX.W1. VEX.W1 is ignored in non-64-bit modes. An attempt to execute this instruction with VEX.L not equal to 0 will cause #UD.

**Operation**

```

N ← SRC2[7:0]
DEST ← SRC1
IF (N < OperandSize)
    DEST[OperandSize-1:N] ← 0
FI
IF (N > OperandSize - 1)
    CF ← 1
ELSE
    CF ← 0
FI

```

**Flags Affected**

ZF, CF and SF flags are updated based on the result. OF flag is cleared. AF and PF flags are undefined.

**Intel C/C++ Compiler Intrinsic Equivalent**

```

BZHI:    unsigned __int32 _bzhi_u32(unsigned __int32 src, unsigned __int32 index);
BZHI:    unsigned __int64 _bzhi_u64(unsigned __int64 src, unsigned __int32 index);

```

**SIMD Floating-Point Exceptions**

None

**Other Exceptions**

See Section 2.5.1, "Exception Conditions for VEX-Encoded GPR Instructions", Table 2-29; additionally #UD If VEX.W = 1.



## CALL—Call Procedure

Opcode	Instruction	Op/En	64-bit Mode	Compat/Leg Mode	Description
E8 <i>cw</i>	CALL <i>rel16</i>	M	N.S.	Valid	Call near, relative, displacement relative to next instruction.
E8 <i>cd</i>	CALL <i>rel32</i>	M	Valid	Valid	Call near, relative, displacement relative to next instruction. 32-bit displacement sign extended to 64-bits in 64-bit mode.
FF <i>12</i>	CALL <i>r/m16</i>	M	N.E.	Valid	Call near, absolute indirect, address given in <i>r/m16</i> .
FF <i>12</i>	CALL <i>r/m32</i>	M	N.E.	Valid	Call near, absolute indirect, address given in <i>r/m32</i> .
FF <i>12</i>	CALL <i>r/m64</i>	M	Valid	N.E.	Call near, absolute indirect, address given in <i>r/m64</i> .
9A <i>cd</i>	CALL <i>ptr16:16</i>	D	Invalid	Valid	Call far, absolute, address given in operand.
9A <i>cp</i>	CALL <i>ptr16:32</i>	D	Invalid	Valid	Call far, absolute, address given in operand.
FF <i>13</i>	CALL <i>m16:16</i>	M	Valid	Valid	Call far, absolute indirect address given in <i>m16:16</i> . In 32-bit mode: if selector points to a gate, then RIP = 32-bit zero extended displacement taken from gate; else RIP = zero extended 16-bit offset from far pointer referenced in the instruction.
FF <i>13</i>	CALL <i>m16:32</i>	M	Valid	Valid	In 64-bit mode: If selector points to a gate, then RIP = 64-bit displacement taken from gate; else RIP = zero extended 32-bit offset from far pointer referenced in the instruction.
REX.W + FF <i>13</i>	CALL <i>m16:64</i>	M	Valid	N.E.	In 64-bit mode: If selector points to a gate, then RIP = 64-bit displacement taken from gate; else RIP = 64-bit offset from far pointer referenced in the instruction.

### Instruction Operand Encoding

Op/En	Operand 1	Operand 2	Operand 3	Operand 4
D	Offset	NA	NA	NA
M	ModRM:r/m ( <i>r</i> )	NA	NA	NA

### Description

Saves procedure linking information on the stack and branches to the called procedure specified using the target operand. The target operand specifies the address of the first instruction in the called procedure. The operand can be an immediate value, a general-purpose register, or a memory location.

This instruction can be used to execute four types of calls:

- **Near Call** — A call to a procedure in the current code segment (the segment currently pointed to by the CS register), sometimes referred to as an intra-segment call.
- **Far Call** — A call to a procedure located in a different segment than the current code segment, sometimes referred to as an inter-segment call.
- **Inter-privilege-level far call** — A far call to a procedure in a segment at a different privilege level than that of the currently executing program or procedure.
- **Task switch** — A call to a procedure located in a different task.

The latter two call types (inter-privilege-level call and task switch) can only be executed in protected mode. See “Calling Procedures Using Call and RET” in Chapter 6 of the *Intel® 64 and IA-32 Architectures Software Developer’s Manual, Volume 1*, for additional information on near, far, and inter-privilege-level calls. See Chapter 7, “Task Management,” in the *Intel® 64 and IA-32 Architectures Software Developer’s Manual, Volume 3A*, for information on performing task switches with the CALL instruction.

**Near Call.** When executing a near call, the processor pushes the value of the EIP register (which contains the offset of the instruction following the CALL instruction) on the stack (for use later as a return-instruction pointer). The processor then branches to the address in the current code segment specified by the target operand. The target operand specifies either an absolute offset in the code segment (an offset from the base of the code segment) or a relative offset (a signed displacement relative to the current value of the instruction pointer in the EIP register; this value points to the instruction following the CALL instruction). The CS register is not changed on near calls.

For a near call absolute, an absolute offset is specified indirectly in a general-purpose register or a memory location (*r/m16*, *r/m32*, or *r/m64*). The operand-size attribute determines the size of the target operand (16, 32 or 64 bits). When in 64-bit mode, the operand size for near call (and all near branches) is forced to 64-bits. Absolute offsets are loaded directly into the EIP(RIP) register. If the operand size attribute is 16, the upper two bytes of the EIP register are cleared, resulting in a maximum instruction pointer size of 16 bits. When accessing an absolute offset indirectly using the stack pointer [ESP] as the base register, the base value used is the value of the ESP before the instruction executes.

A relative offset (*rel16* or *rel32*) is generally specified as a label in assembly code. But at the machine code level, it is encoded as a signed, 16- or 32-bit immediate value. This value is added to the value in the EIP(RIP) register. In 64-bit mode the relative offset is always a 32-bit immediate value which is sign extended to 64-bits before it is added to the value in the RIP register for the target calculation. As with absolute offsets, the operand-size attribute determines the size of the target operand (16, 32, or 64 bits). In 64-bit mode the target operand will always be 64-bits because the operand size is forced to 64-bits for near branches.

**Far Calls in Real-Address or Virtual-8086 Mode.** When executing a far call in real- address or virtual-8086 mode, the processor pushes the current value of both the CS and EIP registers on the stack for use as a return-instruction pointer. The processor then performs a “far branch” to the code segment and offset specified with the target operand for the called procedure. The target operand specifies an absolute far address either directly with a pointer (*ptr16:16* or *ptr16:32*) or indirectly with a memory location (*m16:16* or *m16:32*). With the pointer method, the segment and offset of the called procedure is encoded in the instruction using a 4-byte (16-bit operand size) or 6-byte (32-bit operand size) far address immediate. With the indirect method, the target operand specifies a memory location that contains a 4-byte (16-bit operand size) or 6-byte (32-bit operand size) far address. The operand-size attribute determines the size of the offset (16 or 32 bits) in the far address. The far address is loaded directly into the CS and EIP registers. If the operand-size attribute is 16, the upper two bytes of the EIP register are cleared.

**Far Calls in Protected Mode.** When the processor is operating in protected mode, the CALL instruction can be used to perform the following types of far calls:

- Far call to the same privilege level
- Far call to a different privilege level (inter-privilege level call)
- Task switch (far call to another task)

In protected mode, the processor always uses the segment selector part of the far address to access the corresponding descriptor in the GDT or LDT. The descriptor type (code segment, call gate, task gate, or TSS) and access rights determine the type of call operation to be performed.

If the selected descriptor is for a code segment, a far call to a code segment at the same privilege level is performed. (If the selected code segment is at a different privilege level and the code segment is non-conforming, a general-protection exception is generated.) A far call to the same privilege level in protected mode is very similar to one carried out in real-address or virtual-8086 mode. The target operand specifies an absolute far address either directly with a pointer (*ptr16:16* or *ptr16:32*) or indirectly with a memory location (*m16:16* or *m16:32*). The operand-size attribute determines the size of the offset (16 or 32 bits) in the far address. The new code segment selector and its descriptor are loaded into CS register; the offset from the instruction is loaded into the EIP register.

A call gate (described in the next paragraph) can also be used to perform a far call to a code segment at the same privilege level. Using this mechanism provides an extra level of indirection and is the preferred method of making calls between 16-bit and 32-bit code segments.

When executing an inter-privilege-level far call, the code segment for the procedure being called must be accessed through a call gate. The segment selector specified by the target operand identifies the call gate. The target operand can specify the call gate segment selector either directly with a pointer (*ptr16:16* or *ptr16:32*) or indirectly with a memory location (*m16:16* or *m16:32*). The processor obtains the segment selector for the new code segment and the new instruction pointer (offset) from the call gate descriptor. (The offset from the target operand is ignored when a call gate is used.)

On inter-privilege-level calls, the processor switches to the stack for the privilege level of the called procedure. The segment selector for the new stack segment is specified in the TSS for the currently running task. The branch to the new code segment occurs after the stack switch. (Note that when using a call gate to perform a far call to a segment at the same privilege level, no stack switch occurs.) On the new stack, the processor pushes the segment selector and stack pointer for the calling procedure's stack, an optional set of parameters from the calling procedure's stack, and the segment selector and instruction pointer for the calling procedure's code segment. (A value in the call gate descriptor determines how many parameters to copy to the new stack.) Finally, the processor branches to the address of the procedure being called within the new code segment.

Executing a task switch with the CALL instruction is similar to executing a call through a call gate. The target operand specifies the segment selector of the task gate for the new task activated by the switch (the offset in the target operand is ignored). The task gate in turn points to the TSS for the new task, which contains the segment selectors for the task's code and stack segments. Note that the TSS also contains the EIP value for the next instruction that was to be executed before the calling task was suspended. This instruction pointer value is loaded into the EIP register to re-start the calling task.

The CALL instruction can also specify the segment selector of the TSS directly, which eliminates the indirection of the task gate. See Chapter 7, "Task Management," in the *Intel® 64 and IA-32 Architectures Software Developer's Manual, Volume 3A*, for information on the mechanics of a task switch.

When you execute a task switch with a CALL instruction, the nested task flag (NT) is set in the EFLAGS register and the new TSS's previous task link field is loaded with the old task's TSS selector. Code is expected to suspend this nested task by executing an IRET instruction which, because the NT flag is set, automatically uses the previous task link to return to the calling task. (See "Task Linking" in Chapter 7 of the *Intel® 64 and IA-32 Architectures Software Developer's Manual, Volume 3A*, for information on nested tasks.) Switching tasks with the CALL instruction differs in this regard from JMP instruction. JMP does not set the NT flag and therefore does not expect an IRET instruction to suspend the task.

**Mixing 16-Bit and 32-Bit Calls.** When making far calls between 16-bit and 32-bit code segments, use a call gate. If the far call is from a 32-bit code segment to a 16-bit code segment, the call should be made from the first 64 KBytes of the 32-bit code segment. This is because the operand-size attribute of the instruction is set to 16, so only a 16-bit return address offset can be saved. Also, the call should be made using a 16-bit call gate so that 16-bit values can be pushed on the stack. See Chapter 21, "Mixing 16-Bit and 32-Bit Code," in the *Intel® 64 and IA-32 Architectures Software Developer's Manual, Volume 3B*, for more information.

**Far Calls in Compatibility Mode.** When the processor is operating in compatibility mode, the CALL instruction can be used to perform the following types of far calls:

- Far call to the same privilege level, remaining in compatibility mode
- Far call to the same privilege level, transitioning to 64-bit mode
- Far call to a different privilege level (inter-privilege level call), transitioning to 64-bit mode

Note that a CALL instruction can not be used to cause a task switch in compatibility mode since task switches are not supported in IA-32e mode.

In compatibility mode, the processor always uses the segment selector part of the far address to access the corresponding descriptor in the GDT or LDT. The descriptor type (code segment, call gate) and access rights determine the type of call operation to be performed.

If the selected descriptor is for a code segment, a far call to a code segment at the same privilege level is performed. (If the selected code segment is at a different privilege level and the code segment is non-conforming, a general-protection exception is generated.) A far call to the same privilege level in compatibility mode is very similar to one carried out in protected mode. The target operand specifies an absolute far address either directly with a pointer (*ptr16:16* or *ptr16:32*) or indirectly with a memory location (*m16:16* or *m16:32*). The operand-size attribute determines the size of the offset (16 or 32 bits) in the far address. The new code segment selector and its descriptor are loaded into CS register and the offset from the instruction is loaded into the EIP register. The difference is that 64-bit mode may be entered. This is specified by the L bit in the new code segment descriptor.

Note that a 64-bit call gate (described in the next paragraph) can also be used to perform a far call to a code segment at the same privilege level. However, using this mechanism requires that the target code segment descriptor have the L bit set, causing an entry to 64-bit mode.

When executing an inter-privilege-level far call, the code segment for the procedure being called must be accessed through a 64-bit call gate. The segment selector specified by the target operand identifies the call gate. The target

operand can specify the call gate segment selector either directly with a pointer (*ptr16:16* or *ptr16:32*) or indirectly with a memory location (*m16:16* or *m16:32*). The processor obtains the segment selector for the new code segment and the new instruction pointer (offset) from the 16-byte call gate descriptor. (The offset from the target operand is ignored when a call gate is used.)

On inter-privilege-level calls, the processor switches to the stack for the privilege level of the called procedure. The segment selector for the new stack segment is set to NULL. The new stack pointer is specified in the TSS for the currently running task. The branch to the new code segment occurs after the stack switch. (Note that when using a call gate to perform a far call to a segment at the same privilege level, an implicit stack switch occurs as a result of entering 64-bit mode. The SS selector is unchanged, but stack segment accesses use a segment base of 0x0, the limit is ignored, and the default stack size is 64-bits. The full value of RSP is used for the offset, of which the upper 32-bits are undefined.) On the new stack, the processor pushes the segment selector and stack pointer for the calling procedure's stack and the segment selector and instruction pointer for the calling procedure's code segment. (Parameter copy is not supported in IA-32e mode.) Finally, the processor branches to the address of the procedure being called within the new code segment.

**Near/(Far) Calls in 64-bit Mode.** When the processor is operating in 64-bit mode, the CALL instruction can be used to perform the following types of far calls:

- Far call to the same privilege level, transitioning to compatibility mode
- Far call to the same privilege level, remaining in 64-bit mode
- Far call to a different privilege level (inter-privilege level call), remaining in 64-bit mode

Note that in this mode the CALL instruction can not be used to cause a task switch in 64-bit mode since task switches are not supported in IA-32e mode.

In 64-bit mode, the processor always uses the segment selector part of the far address to access the corresponding descriptor in the GDT or LDT. The descriptor type (code segment, call gate) and access rights determine the type of call operation to be performed.

If the selected descriptor is for a code segment, a far call to a code segment at the same privilege level is performed. (If the selected code segment is at a different privilege level and the code segment is non-conforming, a general-protection exception is generated.) A far call to the same privilege level in 64-bit mode is very similar to one carried out in compatibility mode. The target operand specifies an absolute far address indirectly with a memory location (*m16:16*, *m16:32* or *m16:64*). The form of CALL with a direct specification of absolute far address is not defined in 64-bit mode. The operand-size attribute determines the size of the offset (16, 32, or 64 bits) in the far address. The new code segment selector and its descriptor are loaded into the CS register; the offset from the instruction is loaded into the EIP register. The new code segment may specify entry either into compatibility or 64-bit mode, based on the L bit value.

A 64-bit call gate (described in the next paragraph) can also be used to perform a far call to a code segment at the same privilege level. However, using this mechanism requires that the target code segment descriptor have the L bit set.

When executing an inter-privilege-level far call, the code segment for the procedure being called must be accessed through a 64-bit call gate. The segment selector specified by the target operand identifies the call gate. The target operand can only specify the call gate segment selector indirectly with a memory location (*m16:16*, *m16:32* or *m16:64*). The processor obtains the segment selector for the new code segment and the new instruction pointer (offset) from the 16-byte call gate descriptor. (The offset from the target operand is ignored when a call gate is used.)

On inter-privilege-level calls, the processor switches to the stack for the privilege level of the called procedure. The segment selector for the new stack segment is set to NULL. The new stack pointer is specified in the TSS for the currently running task. The branch to the new code segment occurs after the stack switch.

Note that when using a call gate to perform a far call to a segment at the same privilege level, an implicit stack switch occurs as a result of entering 64-bit mode. The SS selector is unchanged, but stack segment accesses use a segment base of 0x0, the limit is ignored, and the default stack size is 64-bits. (The full value of RSP is used for the offset.) On the new stack, the processor pushes the segment selector and stack pointer for the calling procedure's stack and the segment selector and instruction pointer for the calling procedure's code segment. (Parameter copy is not supported in IA-32e mode.) Finally, the processor branches to the address of the procedure being called within the new code segment.

## Operation

```

IF near call
  THEN IF near relative call
    THEN
      IF OperandSize = 64
        THEN
          tempDEST ← SignExtend(DEST); (* DEST is rel32 *)
          tempRIP ← RIP + tempDEST;
          IF stack not large enough for a 8-byte return address
            THEN #SS(0); FI;
          Push(RIP);
          RIP ← tempRIP;
        FI;
      IF OperandSize = 32
        THEN
          tempEIP ← EIP + DEST; (* DEST is rel32 *)
          IF tempEIP is not within code segment limit THEN #GP(0); FI;
          IF stack not large enough for a 4-byte return address
            THEN #SS(0); FI;
          Push(EIP);
          EIP ← tempEIP;
        FI;
      IF OperandSize = 16
        THEN
          tempEIP ← (EIP + DEST) AND 0000FFFFH; (* DEST is rel16 *)
          IF tempEIP is not within code segment limit THEN #GP(0); FI;
          IF stack not large enough for a 2-byte return address
            THEN #SS(0); FI;
          Push(IP);
          EIP ← tempEIP;
        FI;
    ELSE (* Near absolute call *)
      IF OperandSize = 64
        THEN
          tempRIP ← DEST; (* DEST is r/m64 *)
          IF stack not large enough for a 8-byte return address
            THEN #SS(0); FI;
          Push(RIP);
          RIP ← tempRIP;
        FI;
      IF OperandSize = 32
        THEN
          tempEIP ← DEST; (* DEST is r/m32 *)
          IF tempEIP is not within code segment limit THEN #GP(0); FI;
          IF stack not large enough for a 4-byte return address
            THEN #SS(0); FI;
          Push(EIP);
          EIP ← tempEIP;
        FI;
      IF OperandSize = 16
        THEN
          tempEIP ← DEST AND 0000FFFFH; (* DEST is r/m16 *)
          IF tempEIP is not within code segment limit THEN #GP(0); FI;

```

```

        IF stack not large enough for a 2-byte return address
            THEN #SS(0); FI;
        Push(IP);
        EIP ← tempEIP;
    FI;
FI;rel/abs
FI; near

IF far call and (PE = 0 or (PE = 1 and VM = 1)) (* Real-address or virtual-8086 mode *)
    THEN
        IF OperandSize = 32
            THEN
                IF stack not large enough for a 6-byte return address
                    THEN #SS(0); FI;
                IF DEST[31:16] is not zero THEN #GP(0); FI;
                Push(CS); (* Padded with 16 high-order bits *)
                Push(EIP);
                CS ← DEST[47:32]; (* DEST is ptr16:32 or [m16:32] *)
                EIP ← DEST[31:0]; (* DEST is ptr16:32 or [m16:32] *)
            ELSE (* OperandSize = 16 *)
                IF stack not large enough for a 4-byte return address
                    THEN #SS(0); FI;
                Push(CS);
                Push(IP);
                CS ← DEST[31:16]; (* DEST is ptr16:16 or [m16:16] *)
                EIP ← DEST[15:0]; (* DEST is ptr16:16 or [m16:16]; clear upper 16 bits *)
            FI;
    FI;
FI;

IF far call and (PE = 1 and VM = 0) (* Protected mode or IA-32e Mode, not virtual-8086 mode*)
    THEN
        IF segment selector in target operand NULL
            THEN #GP(0); FI;
        IF segment selector index not within descriptor table limits
            THEN #GP(new code segment selector); FI;
        Read type and access rights of selected segment descriptor;
        IF IA32_EFER.LMA = 0
            THEN
                IF segment type is not a conforming or nonconforming code segment, call
                gate, task gate, or TSS
                    THEN #GP(segment selector); FI;
            ELSE
                IF segment type is not a conforming or nonconforming code segment or
                64-bit call gate,
                    THEN #GP(segment selector); FI;
        FI;
        Depending on type and access rights:
        GO TO CONFORMING-CODE-SEGMENT;
        GO TO NONCONFORMING-CODE-SEGMENT;
        GO TO CALL-GATE;
        GO TO TASK-GATE;
        GO TO TASK-STATE-SEGMENT;
    FI;
FI;

```

## CONFORMING-CODE-SEGMENT:

```

IF L bit = 1 and D bit = 1 and IA32_EFER.LMA = 1
    THEN GP(new code segment selector); FI;
IF DPL > CPL
    THEN #GP(new code segment selector); FI;
IF segment not present
    THEN #NP(new code segment selector); FI;
IF stack not large enough for return address
    THEN #SS(0); FI;
tempEIP ← DEST(Offset);
IF target mode = Compatibility mode
    THEN tempEIP ← tempEIP AND 00000000_FFFFFFFFH; FI;
IF OperandSize = 16
    THEN
        tempEIP ← tempEIP AND 0000FFFFH; FI; (* Clear upper 16 bits *)
IF (EFER.LMA = 0 or target mode = Compatibility mode) and (tempEIP outside new code
segment limit)
    THEN #GP(0); FI;
IF tempEIP is non-canonical
    THEN #GP(0); FI;
IF OperandSize = 32
    THEN
        Push(CS); (* Padded with 16 high-order bits *)
        Push(EIP);
        CS ← DEST(CodeSegmentSelector);
        (* Segment descriptor information also loaded *)
        CS(RPL) ← CPL;
        EIP ← tempEIP;
    ELSE
        IF OperandSize = 16
            THEN
                Push(CS);
                Push(IP);
                CS ← DEST(CodeSegmentSelector);
                (* Segment descriptor information also loaded *)
                CS(RPL) ← CPL;
                EIP ← tempEIP;
            ELSE (* OperandSize = 64 *)
                Push(CS); (* Padded with 48 high-order bits *)
                Push(RIP);
                CS ← DEST(CodeSegmentSelector);
                (* Segment descriptor information also loaded *)
                CS(RPL) ← CPL;
                RIP ← tempEIP;
        FI;
FI;
END;

```

## NONCONFORMING-CODE-SEGMENT:

```

IF L-Bit = 1 and D-BIT = 1 and IA32_EFER.LMA = 1
    THEN GP(new code segment selector); FI;
IF (RPL > CPL) or (DPL ≠ CPL)
    THEN #GP(new code segment selector); FI;
IF segment not present

```

```

    THEN #NP(new code segment selector); FI;
IF stack not large enough for return address
    THEN #SS(0); FI;
tempEIP ← DEST(Offset);
IF target mode = Compatibility mode
    THEN tempEIP ← tempEIP AND 00000000_FFFFFFFFH; FI;
IF OperandSize = 16
    THEN tempEIP ← tempEIP AND 0000FFFFH; FI; (* Clear upper 16 bits *)
IF (EFER.LMA = 0 or target mode = Compatibility mode) and (tempEIP outside new code
segment limit)
    THEN #GP(0); FI;
IF tempEIP is non-canonical
    THEN #GP(0); FI;
IF OperandSize = 32
    THEN
        Push(CS); (* Padded with 16 high-order bits *)
        Push(EIP);
        CS ← DEST(CodeSegmentSelector);
        (* Segment descriptor information also loaded *)
        CS(RPL) ← CPL;
        EIP ← tempEIP;
    ELSE
        IF OperandSize = 16
            THEN
                Push(CS);
                Push(IP);
                CS ← DEST(CodeSegmentSelector);
                (* Segment descriptor information also loaded *)
                CS(RPL) ← CPL;
                EIP ← tempEIP;
            ELSE (* OperandSize = 64 *)
                Push(CS); (* Padded with 48 high-order bits *)
                Push(RIP);
                CS ← DEST(CodeSegmentSelector);
                (* Segment descriptor information also loaded *)
                CS(RPL) ← CPL;
                RIP ← tempEIP;
            FI;
        FI;
END;

```

## CALL-GATE:

```

IF call gate (DPL < CPL) or (RPL > DPL)
    THEN #GP(call-gate selector); FI;
IF call gate not present
    THEN #NP(call-gate selector); FI;
IF call-gate code-segment selector is NULL
    THEN #GP(0); FI;
IF call-gate code-segment selector index is outside descriptor table limits
    THEN #GP(call-gate code-segment selector); FI;
Read call-gate code-segment descriptor;
IF call-gate code-segment descriptor does not indicate a code segment
or call-gate code-segment descriptor DPL > CPL
    THEN #GP(call-gate code-segment selector); FI;

```



```

IF IA32_EFER.LMA = 1 AND (call-gate code-segment descriptor is
not a 64-bit code segment or call-gate code-segment descriptor has both L-bit and D-bit set)
    THEN #GP(call-gate code-segment selector); FI;
IF call-gate code segment not present
    THEN #NP(call-gate code-segment selector); FI;
IF call-gate code segment is non-conforming and DPL < CPL
    THEN go to MORE-PRIVILEGE;
    ELSE go to SAME-PRIVILEGE;
FI;
END;

MORE-PRIVILEGE:
IF current TSS is 32-bit
    THEN
        TSSstackAddress ← (new code-segment DPL * 8) + 4;
        IF (TSSstackAddress + 5) > current TSS limit
            THEN #TS(current TSS selector); FI;
        NewSS ← 2 bytes loaded from (TSS base + TSSstackAddress + 4);
        NewESP ← 4 bytes loaded from (TSS base + TSSstackAddress);
    ELSE
        IF current TSS is 16-bit
            THEN
                TSSstackAddress ← (new code-segment DPL * 4) + 2
                IF (TSSstackAddress + 3) > current TSS limit
                    THEN #TS(current TSS selector); FI;
                NewSS ← 2 bytes loaded from (TSS base + TSSstackAddress + 2);
                NewESP ← 2 bytes loaded from (TSS base + TSSstackAddress);
            ELSE (* current TSS is 64-bit *)
                TSSstackAddress ← (new code-segment DPL * 8) + 4;
                IF (TSSstackAddress + 7) > current TSS limit
                    THEN #TS(current TSS selector); FI;
                NewSS ← new code-segment DPL; (* NULL selector with RPL = new CPL *)
                NewRSP ← 8 bytes loaded from (current TSS base + TSSstackAddress);
        FI;
    FI;
IF IA32_EFER.LMA = 0 and NewSS is NULL
    THEN #TS(NewSS); FI;
Read new stack-segment descriptor;
IF IA32_EFER.LMA = 0 and (NewSS RPL ≠ new code-segment DPL
or new stack-segment DPL ≠ new code-segment DPL or new stack segment is not a
writable data segment)
    THEN #TS(NewSS); FI;
IF IA32_EFER.LMA = 0 and new stack segment not present
    THEN #SS(NewSS); FI;
IF CallGateSize = 32
    THEN
        IF new stack does not have room for parameters plus 16 bytes
            THEN #SS(NewSS); FI;
        IF CallGate(InstructionPointer) not within new code-segment limit
            THEN #GP(0); FI;
        SS ← newSS; (* Segment descriptor information also loaded *)
        ESP ← newESP;
        CS:EIP ← CallGate(CS:InstructionPointer);
        (* Segment descriptor information also loaded *)

```

```

    Push(oldSS:oldESP); (* From calling procedure *)
    temp ← parameter count from call gate, masked to 5 bits;
    Push(parameters from calling procedure's stack, temp)
    Push(oldCS:oldEIP); (* Return address to calling procedure *)
ELSE
    IF CallGateSize = 16
        THEN
            IF new stack does not have room for parameters plus 8 bytes
                THEN #SS(NewSS); FI;
            IF (CallGate(InstructionPointer) AND FFFFH) not in new code-segment limit
                THEN #GP(0); FI;
            SS ← newSS; (* Segment descriptor information also loaded *)
            ESP ← newESP;
            CS:IP ← CallGate(CS:InstructionPointer);
            (* Segment descriptor information also loaded *)
            Push(oldSS:oldESP); (* From calling procedure *)
            temp ← parameter count from call gate, masked to 5 bits;
            Push(parameters from calling procedure's stack, temp)
            Push(oldCS:oldEIP); (* Return address to calling procedure *)
        ELSE (* CallGateSize = 64 *)
            IF pushing 32 bytes on the stack would use a non-canonical address
                THEN #SS(NewSS); FI;
            IF (CallGate(InstructionPointer) is non-canonical)
                THEN #GP(0); FI;
            SS ← NewSS; (* NewSS is NULL)
            RSP ← NewESP;
            CS:IP ← CallGate(CS:InstructionPointer);
            (* Segment descriptor information also loaded *)
            Push(oldSS:oldESP); (* From calling procedure *)
            Push(oldCS:oldEIP); (* Return address to calling procedure *)
        FI;
    FI;
    CPL ← CodeSegment(DPL)
    CS(RPL) ← CPL
END;

```

## SAME-PRIVILEGE:

```

    IF CallGateSize = 32
        THEN
            IF stack does not have room for 8 bytes
                THEN #SS(0); FI;
            IF CallGate(InstructionPointer) not within code segment limit
                THEN #GP(0); FI;
            CS:EIP ← CallGate(CS:EIP) (* Segment descriptor information also loaded *)
            Push(oldCS:oldEIP); (* Return address to calling procedure *)
        ELSE
            If CallGateSize = 16
                THEN
                    IF stack does not have room for 4 bytes
                        THEN #SS(0); FI;
                    IF CallGate(InstructionPointer) not within code segment limit
                        THEN #GP(0); FI;
                    CS:IP ← CallGate(CS:instruction pointer);
                    (* Segment descriptor information also loaded *)
                FI;
        FI;

```

```

        Push(oldCS:oldIP); (* Return address to calling procedure *)
    ELSE (* CallGateSize = 64)
        IF pushing 16 bytes on the stack touches non-canonical addresses
            THEN #SS(0); FI;
        IF RIP non-canonical
            THEN #GP(0); FI;
        CS:IP ← CallGate(CS:instruction pointer);
        (* Segment descriptor information also loaded *)
        Push(oldCS:oldIP); (* Return address to calling procedure *)
    FI;
FI;
CS(RPL) ← CPL
END;

```

```

TASK-GATE:
    IF task gate DPL < CPL or RPL
        THEN #GP(task gate selector); FI;
    IF task gate not present
        THEN #NP(task gate selector); FI;
    Read the TSS segment selector in the task-gate descriptor;
    IF TSS segment selector local/global bit is set to local
    or index not within GDT limits
        THEN #GP(TSS selector); FI;
    Access TSS descriptor in GDT;
    IF descriptor is not a TSS segment
        THEN #GP(TSS selector); FI;
    IF TSS descriptor specifies that the TSS is busy
        THEN #GP(TSS selector); FI;
    IF TSS not present
        THEN #NP(TSS selector); FI;
    SWITCH-TASKS (with nesting) to TSS;
    IF EIP not within code segment limit
        THEN #GP(0); FI;
END;

```

```

TASK-STATE-SEGMENT:
    IF TSS DPL < CPL or RPL
    or TSS descriptor indicates TSS not available
        THEN #GP(TSS selector); FI;
    IF TSS is not present
        THEN #NP(TSS selector); FI;
    SWITCH-TASKS (with nesting) to TSS;
    IF EIP not within code segment limit
        THEN #GP(0); FI;
END;

```

### Flags Affected

All flags are affected if a task switch occurs; no flags are affected if a task switch does not occur.

**Protected Mode Exceptions**

#GP(0)	<p>If the target offset in destination operand is beyond the new code segment limit.</p> <p>If the segment selector in the destination operand is NULL.</p> <p>If the code segment selector in the gate is NULL.</p> <p>If a memory operand effective address is outside the CS, DS, ES, FS, or GS segment limit.</p> <p>If the DS, ES, FS, or GS register is used to access memory and it contains a NULL segment selector.</p>
#GP(selector)	<p>If a code segment or gate or TSS selector index is outside descriptor table limits.</p> <p>If the segment descriptor pointed to by the segment selector in the destination operand is not for a conforming-code segment, nonconforming-code segment, call gate, task gate, or task state segment.</p> <p>If the DPL for a nonconforming-code segment is not equal to the CPL or the RPL for the segment's segment selector is greater than the CPL.</p> <p>If the DPL for a conforming-code segment is greater than the CPL.</p> <p>If the DPL from a call-gate, task-gate, or TSS segment descriptor is less than the CPL or than the RPL of the call-gate, task-gate, or TSS's segment selector.</p> <p>If the segment descriptor for a segment selector from a call gate does not indicate it is a code segment.</p> <p>If the segment selector from a call gate is beyond the descriptor table limits.</p> <p>If the DPL for a code-segment obtained from a call gate is greater than the CPL.</p> <p>If the segment selector for a TSS has its local/global bit set for local.</p> <p>If a TSS segment descriptor specifies that the TSS is busy or not available.</p>
#SS(0)	<p>If pushing the return address, parameters, or stack segment pointer onto the stack exceeds the bounds of the stack segment, when no stack switch occurs.</p> <p>If a memory operand effective address is outside the SS segment limit.</p>
#SS(selector)	<p>If pushing the return address, parameters, or stack segment pointer onto the stack exceeds the bounds of the stack segment, when a stack switch occurs.</p> <p>If the SS register is being loaded as part of a stack switch and the segment pointed to is marked not present.</p> <p>If stack segment does not have room for the return address, parameters, or stack segment pointer, when stack switch occurs.</p>
#NP(selector)	<p>If a code segment, data segment, call gate, task gate, or TSS is not present.</p>
#TS(selector)	<p>If the new stack segment selector and ESP are beyond the end of the TSS.</p> <p>If the new stack segment selector is NULL.</p> <p>If the RPL of the new stack segment selector in the TSS is not equal to the DPL of the code segment being accessed.</p> <p>If DPL of the stack segment descriptor for the new stack segment is not equal to the DPL of the code segment descriptor.</p> <p>If the new stack segment is not a writable data segment.</p> <p>If segment-selector index for stack segment is outside descriptor table limits.</p>
#PF(fault-code)	<p>If a page fault occurs.</p>
#AC(0)	<p>If alignment checking is enabled and an unaligned memory reference is made while the current privilege level is 3.</p>
#UD	<p>If the LOCK prefix is used.</p>

**Real-Address Mode Exceptions**

#GP	<p>If a memory operand effective address is outside the CS, DS, ES, FS, or GS segment limit.</p> <p>If the target offset is beyond the code segment limit.</p>
#UD	<p>If the LOCK prefix is used.</p>

### Virtual-8086 Mode Exceptions

#GP(0)	If a memory operand effective address is outside the CS, DS, ES, FS, or GS segment limit. If the target offset is beyond the code segment limit.
#PF(fault-code)	If a page fault occurs.
#AC(0)	If alignment checking is enabled and an unaligned memory reference is made.
#UD	If the LOCK prefix is used.

### Compatibility Mode Exceptions

Same exceptions as in protected mode.

#GP(selector)	If a memory address accessed by the selector is in non-canonical space.
#GP(0)	If the target offset in the destination operand is non-canonical.

### 64-Bit Mode Exceptions

#GP(0)	If a memory address is non-canonical. If target offset in destination operand is non-canonical. If the segment selector in the destination operand is NULL. If the code segment selector in the 64-bit gate is NULL.
#GP(selector)	If code segment or 64-bit call gate is outside descriptor table limits. If code segment or 64-bit call gate overlaps non-canonical space. If the segment descriptor pointed to by the segment selector in the destination operand is not for a conforming-code segment, nonconforming-code segment, or 64-bit call gate. If the segment descriptor pointed to by the segment selector in the destination operand is a code segment and has both the D-bit and the L-bit set. If the DPL for a nonconforming-code segment is not equal to the CPL, or the RPL for the segment's segment selector is greater than the CPL. If the DPL for a conforming-code segment is greater than the CPL. If the DPL from a 64-bit call-gate is less than the CPL or than the RPL of the 64-bit call-gate. If the upper type field of a 64-bit call gate is not 0x0. If the segment selector from a 64-bit call gate is beyond the descriptor table limits. If the DPL for a code-segment obtained from a 64-bit call gate is greater than the CPL. If the code segment descriptor pointed to by the selector in the 64-bit gate doesn't have the L-bit set and the D-bit clear. If the segment descriptor for a segment selector from the 64-bit call gate does not indicate it is a code segment.
#SS(0)	If pushing the return offset or CS selector onto the stack exceeds the bounds of the stack segment when no stack switch occurs. If a memory operand effective address is outside the SS segment limit. If the stack address is in a non-canonical form.
#SS(selector)	If pushing the old values of SS selector, stack pointer, EFLAGS, CS selector, offset, or error code onto the stack violates the canonical boundary when a stack switch occurs.
#NP(selector)	If a code segment or 64-bit call gate is not present.
#TS(selector)	If the load of the new RSP exceeds the limit of the TSS.
#UD	(64-bit mode only) If a far call is direct to an absolute address in memory. If the LOCK prefix is used.
#PF(fault-code)	If a page fault occurs.
#AC(0)	If alignment checking is enabled and an unaligned memory reference is made while the current privilege level is 3.

## CBW/CWDE/CDQE—Convert Byte to Word/Convert Word to Doubleword/Convert Doubleword to Quadword

Opcode	Instruction	Op/En	64-bit Mode	Compat/Leg Mode	Description
98	CBW	Z0	Valid	Valid	AX ← sign-extend of AL.
98	CWDE	Z0	Valid	Valid	EAX ← sign-extend of AX.
REX.W + 98	CDQE	Z0	Valid	N.E.	RAX ← sign-extend of EAX.

### Instruction Operand Encoding

Op/En	Operand 1	Operand 2	Operand 3	Operand 4
Z0	NA	NA	NA	NA

### Description

Double the size of the source operand by means of sign extension. The CBW (convert byte to word) instruction copies the sign (bit 7) in the source operand into every bit in the AH register. The CWDE (convert word to doubleword) instruction copies the sign (bit 15) of the word in the AX register into the high 16 bits of the EAX register.

CBW and CWDE reference the same opcode. The CBW instruction is intended for use when the operand-size attribute is 16; CWDE is intended for use when the operand-size attribute is 32. Some assemblers may force the operand size. Others may treat these two mnemonics as synonyms (CBW/CWDE) and use the setting of the operand-size attribute to determine the size of values to be converted.

In 64-bit mode, the default operation size is the size of the destination register. Use of the REX.W prefix promotes this instruction (CDQE when promoted) to operate on 64-bit operands. In which case, CDQE copies the sign (bit 31) of the doubleword in the EAX register into the high 32 bits of RAX.

### Operation

```
IF OperandSize = 16 (* Instruction = CBW *)
  THEN
    AX ← SignExtend(AL);
  ELSE IF (OperandSize = 32, Instruction = CWDE)
    EAX ← SignExtend(AX); FI;
  ELSE (* 64-Bit Mode, OperandSize = 64, Instruction = CDQE*)
    RAX ← SignExtend(EAX);
  FI;
```

### Flags Affected

None.

### Exceptions (All Operating Modes)

#UD If the LOCK prefix is used.

## CLAC—Clear AC Flag in EFLAGS Register

Opcode/ Instruction	Op / En	64/32 bit Mode Support	CPUID Feature Flag	Description
NP 0F 01 CA CLAC	Z0	V/V	SMAP	Clear the AC flag in the EFLAGS register.

### Instruction Operand Encoding

Op/En	Operand 1	Operand 2	Operand 3	Operand 4
Z0	NA	NA	NA	NA

### Description

Clears the AC flag bit in EFLAGS register. This disables any alignment checking of user-mode data accesses. If the SMAP bit is set in the CR4 register, this disallows explicit supervisor-mode data accesses to user-mode pages.

This instruction's operation is the same in non-64-bit modes and 64-bit mode. Attempts to execute CLAC when CPL > 0 cause #UD.

### Operation

EFLAGS.AC ← 0;

### Flags Affected

AC cleared. Other flags are unaffected.

### Protected Mode Exceptions

#UD                    If the LOCK prefix is used.  
                           If the CPL > 0.  
                           If CPUID.(EAX=07H, ECX=0H):EBX.SMAP[bit 20] = 0.

### Real-Address Mode Exceptions

#UD                    If the LOCK prefix is used.  
                           If CPUID.(EAX=07H, ECX=0H):EBX.SMAP[bit 20] = 0.

### Virtual-8086 Mode Exceptions

#UD                    The CLAC instruction is not recognized in virtual-8086 mode.

### Compatibility Mode Exceptions

#UD                    If the LOCK prefix is used.  
                           If the CPL > 0.  
                           If CPUID.(EAX=07H, ECX=0H):EBX.SMAP[bit 20] = 0.

### 64-Bit Mode Exceptions

#UD                    If the LOCK prefix is used.  
                           If the CPL > 0.  
                           If CPUID.(EAX=07H, ECX=0H):EBX.SMAP[bit 20] = 0.

**CLC—Clear Carry Flag**

Opcode	Instruction	Op/En	64-bit Mode	Compat/Leg Mode	Description
F8	CLC	Z0	Valid	Valid	Clear CF flag.

**Instruction Operand Encoding**

Op/En	Operand 1	Operand 2	Operand 3	Operand 4
Z0	NA	NA	NA	NA

**Description**

Clears the CF flag in the EFLAGS register. Operation is the same in all modes.

**Operation**

CF ← 0;

**Flags Affected**

The CF flag is set to 0. The OF, ZF, SF, AF, and PF flags are unaffected.

**Exceptions (All Operating Modes)**

#UD                      If the LOCK prefix is used.



## CLD—Clear Direction Flag

Opcode	Instruction	Op/En	64-bit Mode	Compat/Leg Mode	Description
FC	CLD	Z0	Valid	Valid	Clear DF flag.

### Instruction Operand Encoding

Op/En	Operand 1	Operand 2	Operand 3	Operand 4
Z0	NA	NA	NA	NA

### Description

Clears the DF flag in the EFLAGS register. When the DF flag is set to 0, string operations increment the index registers (ESI and/or EDI). Operation is the same in all modes.

### Operation

DF ← 0;

### Flags Affected

The DF flag is set to 0. The CF, OF, ZF, SF, AF, and PF flags are unaffected.

### Exceptions (All Operating Modes)

#UD If the LOCK prefix is used.

## CLFLUSH—Flush Cache Line

Opcode	Instruction	Op/En	64-bit Mode	Compat/Leg Mode	Description
NP OF AE /7	CLFLUSH <i>m8</i>	M	Valid	Valid	Flushes cache line containing <i>m8</i> .

### Instruction Operand Encoding

Op/En	Operand 1	Operand 2	Operand 3	Operand 4
M	ModRM:r/m ( <i>w</i> )	NA	NA	NA

### Description

Invalidates from every level of the cache hierarchy in the cache coherence domain the cache line that contains the linear address specified with the memory operand. If that cache line contains modified data at any level of the cache hierarchy, that data is written back to memory. The source operand is a byte memory location.

The availability of CLFLUSH is indicated by the presence of the CPUID feature flag CLFSH (CPUID.01H:EDX[bit 19]). The aligned cache line size affected is also indicated with the CPUID instruction (bits 8 through 15 of the EBX register when the initial value in the EAX register is 1).

The memory attribute of the page containing the affected line has no effect on the behavior of this instruction. It should be noted that processors are free to speculatively fetch and cache data from system memory regions assigned a memory-type allowing for speculative reads (such as, the WB, WC, and WT memory types). PREFETCH $h$  instructions can be used to provide the processor with hints for this speculative behavior. Because this speculative fetching can occur at any time and is not tied to instruction execution, the CLFLUSH instruction is not ordered with respect to PREFETCH $h$  instructions or any of the speculative fetching mechanisms (that is, data can be speculatively loaded into a cache line just before, during, or after the execution of a CLFLUSH instruction that references the cache line).

Executions of the CLFLUSH instruction are ordered with respect to each other and with respect to writes, locked read-modify-write instructions, fence instructions, and executions of CLFLUSHOPT to the same cache line.<sup>1</sup> They are not ordered with respect to executions of CLFLUSHOPT to different cache lines.

The CLFLUSH instruction can be used at all privilege levels and is subject to all permission checking and faults associated with a byte load (and in addition, a CLFLUSH instruction is allowed to flush a linear address in an execute-only segment). Like a load, the CLFLUSH instruction sets the A bit but not the D bit in the page tables.

In some implementations, the CLFLUSH instruction may always cause transactional abort with Transactional Synchronization Extensions (TSX). The CLFLUSH instruction is not expected to be commonly used inside typical transactional regions. However, programmers must not rely on CLFLUSH instruction to force a transactional abort, since whether they cause transactional abort is implementation dependent.

The CLFLUSH instruction was introduced with the SSE2 extensions; however, because it has its own CPUID feature flag, it can be implemented in IA-32 processors that do not include the SSE2 extensions. Also, detecting the presence of the SSE2 extensions with the CPUID instruction does not guarantee that the CLFLUSH instruction is implemented in the processor.

CLFLUSH operation is the same in non-64-bit modes and 64-bit mode.

### Operation

Flush\_Cache\_Line(SRC);

### Intel C/C++ Compiler Intrinsic Equivalents

CLFLUSH: `void _mm_clflush(void const *p)`

1. Earlier versions of this manual specified that executions of the CLFLUSH instruction were ordered only by the MFENCE instruction. All processors implementing the CLFLUSH instruction also order it relative to the other operations enumerated above.

**Protected Mode Exceptions**

#GP(0)	For an illegal memory operand effective address in the CS, DS, ES, FS or GS segments.
#SS(0)	For an illegal address in the SS segment.
#PF(fault-code)	For a page fault.
#UD	If CPUID.01H:EDX.CLFSH[bit 19] = 0. If the LOCK prefix is used.

**Real-Address Mode Exceptions**

#GP	If any part of the operand lies outside the effective address space from 0 to FFFFH.
#UD	If CPUID.01H:EDX.CLFSH[bit 19] = 0. If the LOCK prefix is used.

**Virtual-8086 Mode Exceptions**

Same exceptions as in real address mode.

#PF(fault-code)	For a page fault.
-----------------	-------------------

**Compatibility Mode Exceptions**

Same exceptions as in protected mode.

**64-Bit Mode Exceptions**

#SS(0)	If a memory address referencing the SS segment is in a non-canonical form.
#GP(0)	If the memory address is in a non-canonical form.
#PF(fault-code)	For a page fault.
#UD	If CPUID.01H:EDX.CLFSH[bit 19] = 0. If the LOCK prefix is used.

## CLFLUSHOPT—Flush Cache Line Optimized

Opcode	Instruction	Op/En	64-bit Mode	Compat/Leg Mode	Description
66 0F AE 7	CLFLUSHOPT <i>m8</i>	M	Valid	Valid	Flushes cache line containing <i>m8</i> .

### Instruction Operand Encoding

Op/En	Operand 1	Operand 2	Operand 3	Operand 4
M	ModRM:r/m (w)	NA	NA	NA

### Description

Invalidates from every level of the cache hierarchy in the cache coherence domain the cache line that contains the linear address specified with the memory operand. If that cache line contains modified data at any level of the cache hierarchy, that data is written back to memory. The source operand is a byte memory location.

The availability of CLFLUSHOPT is indicated by the presence of the CPUID feature flag CLFLUSHOPT (CPUID.(EAX=7,ECX=0):EBX[bit 23]). The aligned cache line size affected is also indicated with the CPUID instruction (bits 8 through 15 of the EBX register when the initial value in the EAX register is 1).

The memory attribute of the page containing the affected line has no effect on the behavior of this instruction. It should be noted that processors are free to speculatively fetch and cache data from system memory regions assigned a memory-type allowing for speculative reads (such as, the WB, WC, and WT memory types). PREFETCH $h$  instructions can be used to provide the processor with hints for this speculative behavior. Because this speculative fetching can occur at any time and is not tied to instruction execution, the CLFLUSH instruction is not ordered with respect to PREFETCH $h$  instructions or any of the speculative fetching mechanisms (that is, data can be speculatively loaded into a cache line just before, during, or after the execution of a CLFLUSH instruction that references the cache line).

Executions of the CLFLUSHOPT instruction are ordered with respect to fence instructions and to locked read-modify-write instructions; they are also ordered with respect to the following accesses to the cache line being invalidated: writes, executions of CLFLUSH, and executions of CLFLUSHOPT. They are not ordered with respect to writes, executions of CLFLUSH, or executions of CLFLUSHOPT that access other cache lines; to enforce ordering with such an operation, software can insert an SFENCE instruction between CLFLUSHOPT and that operation.

The CLFLUSHOPT instruction can be used at all privilege levels and is subject to all permission checking and faults associated with a byte load (and in addition, a CLFLUSHOPT instruction is allowed to flush a linear address in an execute-only segment). Like a load, the CLFLUSHOPT instruction sets the A bit but not the D bit in the page tables.

In some implementations, the CLFLUSHOPT instruction may always cause transactional abort with Transactional Synchronization Extensions (TSX). The CLFLUSHOPT instruction is not expected to be commonly used inside typical transactional regions. However, programmers must not rely on CLFLUSHOPT instruction to force a transactional abort, since whether they cause transactional abort is implementation dependent.

CLFLUSHOPT operation is the same in non-64-bit modes and 64-bit mode.

### Operation

Flush\_Cache\_Line\_Optimized(SRC);

### Intel C/C++ Compiler Intrinsic Equivalents

CLFLUSHOPT: void \_mm\_clflushopt(void const \*p)

**Protected Mode Exceptions**

#GP(0)	For an illegal memory operand effective address in the CS, DS, ES, FS or GS segments.
#SS(0)	For an illegal address in the SS segment.
#PF(fault-code)	For a page fault.
#UD	If CPUID.(EAX=7,ECX=0):EBX.CLFLUSHOPT[bit 23] = 0. If the LOCK prefix is used. If an instruction prefix F2H or F3H is used.

**Real-Address Mode Exceptions**

#GP	If any part of the operand lies outside the effective address space from 0 to FFFFH.
#UD	If CPUID.(EAX=7,ECX=0):EBX.CLFLUSHOPT[bit 23] = 0. If the LOCK prefix is used. If an instruction prefix F2H or F3H is used.

**Virtual-8086 Mode Exceptions**

Same exceptions as in real address mode.

#PF(fault-code)	For a page fault.
-----------------	-------------------

**Compatibility Mode Exceptions**

Same exceptions as in protected mode.

**64-Bit Mode Exceptions**

#SS(0)	If a memory address referencing the SS segment is in a non-canonical form.
#GP(0)	If the memory address is in a non-canonical form.
#PF(fault-code)	For a page fault.
#UD	If CPUID.(EAX=7,ECX=0):EBX.CLFLUSHOPT[bit 23] = 0. If the LOCK prefix is used. If an instruction prefix F2H or F3H is used.

## CLI – Clear Interrupt Flag

Opcode	Instruction	Op/En	64-bit Mode	Compat/Leg Mode	Description
FA	CLI	Z0	Valid	Valid	Clear interrupt flag; interrupts disabled when interrupt flag cleared.

### Instruction Operand Encoding

Op/En	Operand 1	Operand 2	Operand 3	Operand 4
Z0	NA	NA	NA	NA

### Description

In most cases, CLI clears the IF flag in the EFLAGS register and no other flags are affected. Clearing the IF flag causes the processor to ignore maskable external interrupts. The IF flag and the CLI and STI instruction have no effect on the generation of exceptions and NMI interrupts.

Operation is different in two modes defined as follows:

- **PVI mode** (protected-mode virtual interrupts): CR0.PE = 1, EFLAGS.VM = 0, CPL = 3, and CR4.PVI = 1;
- **VME mode** (virtual-8086 mode extensions): CR0.PE = 1, EFLAGS.VM = 1, and CR4.VME = 1.

If IOPL < 3 and either VME mode or PVI mode is active, CLI clears the VIF flag in the EFLAGS register, leaving IF unaffected.

Table 3-7 indicates the action of the CLI instruction depending on the processor operating mode, IOPL, and CPL.

**Table 3-7. Decision Table for CLI Results**

Mode	IOPL	CLI Result
Real-address	X <sup>1</sup>	IF = 0
Protected, not PVI <sup>2</sup>	≥ CPL	IF = 0
	< CPL	#GP fault
Protected, PVI <sup>3</sup>	3	IF = 0
	0-2	VIF = 0
Virtual-8086, not VME <sup>3</sup>	3	IF = 0
	0-2	#GP fault
Virtual-8086, VME <sup>3</sup>	3	IF = 0
	0-2	VIF = 0

### NOTES:

1. X = This setting has no effect on instruction operation.
2. For this table, “protected mode” applies whenever CR0.PE = 1 and EFLAGS.VM = 0; it includes compatibility mode and 64-bit mode.
3. PVI mode and virtual-8086 mode each imply CPL = 3.

## Operation

```

IF CR0.PE = 0
  THEN IF ← 0; (* Reset Interrupt Flag *)
  ELSE
    IF IOPL ≥ CPL (* CPL = 3 if EFLAGS.VM = 1 *)
      THEN IF ← 0; (* Reset Interrupt Flag *)
      ELSE
        IF VME mode OR PVI mode
          THEN VIF ← 0; (* Reset Virtual Interrupt Flag *)
          ELSE #GP(0);
        FI;
      FI;
    FI;
  FI;

```

## Flags Affected

Either the IF flag or the VIF flag is cleared to 0. Other flags are unaffected.

## Protected Mode Exceptions

#GP(0)	If CPL is greater than IOPL and PVI mode is not active.
	If CPL is greater than IOPL and less than 3.
#UD	If the LOCK prefix is used.

## Real-Address Mode Exceptions

#UD	If the LOCK prefix is used.
-----	-----------------------------

## Virtual-8086 Mode Exceptions

#GP(0)	If IOPL is less than 3 and VME mode is not active.
#UD	If the LOCK prefix is used.

## Compatibility Mode Exceptions

Same exceptions as in protected mode.

## 64-Bit Mode Exceptions

Same exceptions as in protected mode.

## CLTS—Clear Task-Switched Flag in CR0

Opcode	Instruction	Op/En	64-bit Mode	Compat/Leg Mode	Description
0F 06	CLTS	Z0	Valid	Valid	Clears TS flag in CR0.

### Instruction Operand Encoding

Op/En	Operand 1	Operand 2	Operand 3	Operand 4
Z0	NA	NA	NA	NA

### Description

Clears the task-switched (TS) flag in the CR0 register. This instruction is intended for use in operating-system procedures. It is a privileged instruction that can only be executed at a CPL of 0. It is allowed to be executed in real-address mode to allow initialization for protected mode.

The processor sets the TS flag every time a task switch occurs. The flag is used to synchronize the saving of FPU context in multitasking applications. See the description of the TS flag in the section titled “Control Registers” in Chapter 2 of the *Intel® 64 and IA-32 Architectures Software Developer’s Manual, Volume 3A*, for more information about this flag.

CLTS operation is the same in non-64-bit modes and 64-bit mode.

See Chapter 25, “VMX Non-Root Operation,” of the *Intel® 64 and IA-32 Architectures Software Developer’s Manual, Volume 3C*, for more information about the behavior of this instruction in VMX non-root operation.

### Operation

CR0.TS[bit 3] ← 0;

### Flags Affected

The TS flag in CR0 register is cleared.

### Protected Mode Exceptions

#GP(0) If the current privilege level is not 0.  
 #UD If the LOCK prefix is used.

### Real-Address Mode Exceptions

#UD If the LOCK prefix is used.

### Virtual-8086 Mode Exceptions

#GP(0) CLTS is not recognized in virtual-8086 mode.  
 #UD If the LOCK prefix is used.

### Compatibility Mode Exceptions

Same exceptions as in protected mode.

### 64-Bit Mode Exceptions

#GP(0) If the CPL is greater than 0.  
 #UD If the LOCK prefix is used.



## CLWB—Cache Line Write Back

Opcode/ Instruction	Op/ En	64/32 bit Mode Support	CPUID Feature Flag	Description
66 OF AE /6 CLWB m8	M	V/V	CLWB	Writes back modified cache line containing m8, and may retain the line in cache hierarchy in non-modified state.

### Instruction Operand Encoding<sup>1</sup>

Op/En	Operand 1	Operand 2	Operand 3	Operand 4
M	ModRM:r/m (w)	NA	NA	NA

### Description

Writes back to memory the cache line (if modified) that contains the linear address specified with the memory operand from any level of the cache hierarchy in the cache coherence domain. The line may be retained in the cache hierarchy in non-modified state. Retaining the line in the cache hierarchy is a performance optimization (treated as a hint by hardware) to reduce the possibility of cache miss on a subsequent access. Hardware may choose to retain the line at any of the levels in the cache hierarchy, and in some cases, may invalidate the line from the cache hierarchy. The source operand is a byte memory location.

The availability of CLWB instruction is indicated by the presence of the CPUID feature flag CLWB (bit 24 of the EBX register, see “CPUID — CPU Identification” in this chapter). The aligned cache line size affected is also indicated with the CPUID instruction (bits 8 through 15 of the EBX register when the initial value in the EAX register is 1).

The memory attribute of the page containing the affected line has no effect on the behavior of this instruction. It should be noted that processors are free to speculatively fetch and cache data from system memory regions that are assigned a memory-type allowing for speculative reads (such as, the WB, WC, and WT memory types). PREFETCHH instructions can be used to provide the processor with hints for this speculative behavior. Because this speculative fetching can occur at any time and is not tied to instruction execution, the CLWB instruction is not ordered with respect to PREFETCHH instructions or any of the speculative fetching mechanisms (that is, data can be speculatively loaded into a cache line just before, during, or after the execution of a CLWB instruction that references the cache line).

CLWB instruction is ordered only by store-fencing operations. For example, software can use an SFENCE, MFENCE, XCHG, or LOCK-prefixed instructions to ensure that previous stores are included in the write-back. CLWB instruction need not be ordered by another CLWB or CLFLUSHOPT instruction. CLWB is implicitly ordered with older stores executed by the logical processor to the same address.

For usages that require only writing back modified data from cache lines to memory (do not require the line to be invalidated), and expect to subsequently access the data, software is recommended to use CLWB (with appropriate fencing) instead of CLFLUSH or CLFLUSHOPT for improved performance.

The CLWB instruction can be used at all privilege levels and is subject to all permission checking and faults associated with a byte load. Like a load, the CLWB instruction sets the accessed flag but not the dirty flag in the page tables.

In some implementations, the CLWB instruction may always cause transactional abort with Transactional Synchronization Extensions (TSX). CLWB instruction is not expected to be commonly used inside typical transactional regions. However, programmers must not rely on CLWB instruction to force a transactional abort, since whether they cause transactional abort is implementation dependent.

### Operation

Cache\_Line\_Write\_Back(m8);

### Flags Affected

None.

1. ModRM.MOD != 011B

**C/C++ Compiler Intrinsic Equivalent**

```
CLWB void _mm_clwb(void const *p);
```

**Protected Mode Exceptions**

#UD	If the LOCK prefix is used. If CPUID.(EAX=07H, ECX=0H):EBX.CLWB[bit 24] = 0.
#GP(0)	For an illegal memory operand effective address in the CS, DS, ES, FS or GS segments.
#SS(0)	For an illegal address in the SS segment.
#PF(fault-code)	For a page fault.

**Real-Address Mode Exceptions**

#UD	If the LOCK prefix is used. If CPUID.(EAX=07H, ECX=0H):EBX.CLWB[bit 24] = 0.
#GP	If any part of the operand lies outside the effective address space from 0 to FFFFH.

**Virtual-8086 Mode Exceptions**

Same exceptions as in real address mode.

#PF(fault-code)	For a page fault.
-----------------	-------------------

**Compatibility Mode Exceptions**

Same exceptions as in protected mode.

**64-Bit Mode Exceptions**

#UD	If the LOCK prefix is used. If CPUID.(EAX=07H, ECX=0H):EBX.CLWB[bit 24] = 0.
#SS(0)	If a memory address referencing the SS segment is in a non-canonical form.
#GP(0)	If the memory address is in a non-canonical form.
#PF(fault-code)	For a page fault.

## CMC—Complement Carry Flag

Opcode	Instruction	Op/En	64-bit Mode	Compat/Leg Mode	Description
F5	CMC	Z0	Valid	Valid	Complement CF flag.

### Instruction Operand Encoding

Op/En	Operand 1	Operand 2	Operand 3	Operand 4
Z0	NA	NA	NA	NA

### Description

Complements the CF flag in the EFLAGS register. CMC operation is the same in non-64-bit modes and 64-bit mode.

### Operation

$EFLAGS.CF[\text{bit } 0] \leftarrow \text{NOT } EFLAGS.CF[\text{bit } 0];$

### Flags Affected

The CF flag contains the complement of its original value. The OF, ZF, SF, AF, and PF flags are unaffected.

### Exceptions (All Operating Modes)

#UD If the LOCK prefix is used.

## CMOVcc—Conditional Move

Opcode	Instruction	Op/En	64-Bit Mode	Compat/Leg Mode	Description
OF 47 /r	CMOVA <i>r16, r/m16</i>	RM	Valid	Valid	Move if above (CF=0 and ZF=0).
OF 47 /r	CMOVA <i>r32, r/m32</i>	RM	Valid	Valid	Move if above (CF=0 and ZF=0).
REX.W + OF 47 /r	CMOVA <i>r64, r/m64</i>	RM	Valid	N.E.	Move if above (CF=0 and ZF=0).
OF 43 /r	CMOVAE <i>r16, r/m16</i>	RM	Valid	Valid	Move if above or equal (CF=0).
OF 43 /r	CMOVAE <i>r32, r/m32</i>	RM	Valid	Valid	Move if above or equal (CF=0).
REX.W + OF 43 /r	CMOVAE <i>r64, r/m64</i>	RM	Valid	N.E.	Move if above or equal (CF=0).
OF 42 /r	CMOVB <i>r16, r/m16</i>	RM	Valid	Valid	Move if below (CF=1).
OF 42 /r	CMOVB <i>r32, r/m32</i>	RM	Valid	Valid	Move if below (CF=1).
REX.W + OF 42 /r	CMOVB <i>r64, r/m64</i>	RM	Valid	N.E.	Move if below (CF=1).
OF 46 /r	CMOVBE <i>r16, r/m16</i>	RM	Valid	Valid	Move if below or equal (CF=1 or ZF=1).
OF 46 /r	CMOVBE <i>r32, r/m32</i>	RM	Valid	Valid	Move if below or equal (CF=1 or ZF=1).
REX.W + OF 46 /r	CMOVBE <i>r64, r/m64</i>	RM	Valid	N.E.	Move if below or equal (CF=1 or ZF=1).
OF 42 /r	CMOVC <i>r16, r/m16</i>	RM	Valid	Valid	Move if carry (CF=1).
OF 42 /r	CMOVC <i>r32, r/m32</i>	RM	Valid	Valid	Move if carry (CF=1).
REX.W + OF 42 /r	CMOVC <i>r64, r/m64</i>	RM	Valid	N.E.	Move if carry (CF=1).
OF 44 /r	CMOVE <i>r16, r/m16</i>	RM	Valid	Valid	Move if equal (ZF=1).
OF 44 /r	CMOVE <i>r32, r/m32</i>	RM	Valid	Valid	Move if equal (ZF=1).
REX.W + OF 44 /r	CMOVE <i>r64, r/m64</i>	RM	Valid	N.E.	Move if equal (ZF=1).
OF 4F /r	CMOVG <i>r16, r/m16</i>	RM	Valid	Valid	Move if greater (ZF=0 and SF=OF).
OF 4F /r	CMOVG <i>r32, r/m32</i>	RM	Valid	Valid	Move if greater (ZF=0 and SF=OF).
REX.W + OF 4F /r	CMOVG <i>r64, r/m64</i>	RM	V/N.E.	NA	Move if greater (ZF=0 and SF=OF).
OF 4D /r	CMOVGE <i>r16, r/m16</i>	RM	Valid	Valid	Move if greater or equal (SF=OF).
OF 4D /r	CMOVGE <i>r32, r/m32</i>	RM	Valid	Valid	Move if greater or equal (SF=OF).
REX.W + OF 4D /r	CMOVGE <i>r64, r/m64</i>	RM	Valid	N.E.	Move if greater or equal (SF=OF).
OF 4C /r	CMOVL <i>r16, r/m16</i>	RM	Valid	Valid	Move if less (SF≠OF).
OF 4C /r	CMOVL <i>r32, r/m32</i>	RM	Valid	Valid	Move if less (SF≠OF).
REX.W + OF 4C /r	CMOVL <i>r64, r/m64</i>	RM	Valid	N.E.	Move if less (SF≠OF).
OF 4E /r	CMOVLE <i>r16, r/m16</i>	RM	Valid	Valid	Move if less or equal (ZF=1 or SF≠OF).
OF 4E /r	CMOVLE <i>r32, r/m32</i>	RM	Valid	Valid	Move if less or equal (ZF=1 or SF≠OF).
REX.W + OF 4E /r	CMOVLE <i>r64, r/m64</i>	RM	Valid	N.E.	Move if less or equal (ZF=1 or SF≠OF).
OF 46 /r	CMOVNA <i>r16, r/m16</i>	RM	Valid	Valid	Move if not above (CF=1 or ZF=1).
OF 46 /r	CMOVNA <i>r32, r/m32</i>	RM	Valid	Valid	Move if not above (CF=1 or ZF=1).
REX.W + OF 46 /r	CMOVNA <i>r64, r/m64</i>	RM	Valid	N.E.	Move if not above (CF=1 or ZF=1).
OF 42 /r	CMOVNAE <i>r16, r/m16</i>	RM	Valid	Valid	Move if not above or equal (CF=1).
OF 42 /r	CMOVNAE <i>r32, r/m32</i>	RM	Valid	Valid	Move if not above or equal (CF=1).
REX.W + OF 42 /r	CMOVNAE <i>r64, r/m64</i>	RM	Valid	N.E.	Move if not above or equal (CF=1).
OF 43 /r	CMOVNB <i>r16, r/m16</i>	RM	Valid	Valid	Move if not below (CF=0).
OF 43 /r	CMOVNB <i>r32, r/m32</i>	RM	Valid	Valid	Move if not below (CF=0).
REX.W + OF 43 /r	CMOVNB <i>r64, r/m64</i>	RM	Valid	N.E.	Move if not below (CF=0).
OF 47 /r	CMOVNBE <i>r16, r/m16</i>	RM	Valid	Valid	Move if not below or equal (CF=0 and ZF=0).

Opcode	Instruction	Op/En	64-Bit Mode	Compat/Leg Mode	Description
OF 47 /r	CMOVNBE <i>r32, r/m32</i>	RM	Valid	Valid	Move if not below or equal (CF=0 and ZF=0).
REX.W + OF 47 /r	CMOVNBE <i>r64, r/m64</i>	RM	Valid	N.E.	Move if not below or equal (CF=0 and ZF=0).
OF 43 /r	CMOVNC <i>r16, r/m16</i>	RM	Valid	Valid	Move if not carry (CF=0).
OF 43 /r	CMOVNC <i>r32, r/m32</i>	RM	Valid	Valid	Move if not carry (CF=0).
REX.W + OF 43 /r	CMOVNC <i>r64, r/m64</i>	RM	Valid	N.E.	Move if not carry (CF=0).
OF 45 /r	CMOVNE <i>r16, r/m16</i>	RM	Valid	Valid	Move if not equal (ZF=0).
OF 45 /r	CMOVNE <i>r32, r/m32</i>	RM	Valid	Valid	Move if not equal (ZF=0).
REX.W + OF 45 /r	CMOVNE <i>r64, r/m64</i>	RM	Valid	N.E.	Move if not equal (ZF=0).
OF 4E /r	CMOVNG <i>r16, r/m16</i>	RM	Valid	Valid	Move if not greater (ZF=1 or SF≠OF).
OF 4E /r	CMOVNG <i>r32, r/m32</i>	RM	Valid	Valid	Move if not greater (ZF=1 or SF≠OF).
REX.W + OF 4E /r	CMOVNG <i>r64, r/m64</i>	RM	Valid	N.E.	Move if not greater (ZF=1 or SF≠OF).
OF 4C /r	CMOVNGE <i>r16, r/m16</i>	RM	Valid	Valid	Move if not greater or equal (SF≠OF).
OF 4C /r	CMOVNGE <i>r32, r/m32</i>	RM	Valid	Valid	Move if not greater or equal (SF≠OF).
REX.W + OF 4C /r	CMOVNGE <i>r64, r/m64</i>	RM	Valid	N.E.	Move if not greater or equal (SF≠OF).
OF 4D /r	CMOVNL <i>r16, r/m16</i>	RM	Valid	Valid	Move if not less (SF=OF).
OF 4D /r	CMOVNL <i>r32, r/m32</i>	RM	Valid	Valid	Move if not less (SF=OF).
REX.W + OF 4D /r	CMOVNL <i>r64, r/m64</i>	RM	Valid	N.E.	Move if not less (SF=OF).
OF 4F /r	CMOVNLE <i>r16, r/m16</i>	RM	Valid	Valid	Move if not less or equal (ZF=0 and SF=OF).
OF 4F /r	CMOVNLE <i>r32, r/m32</i>	RM	Valid	Valid	Move if not less or equal (ZF=0 and SF=OF).
REX.W + OF 4F /r	CMOVNLE <i>r64, r/m64</i>	RM	Valid	N.E.	Move if not less or equal (ZF=0 and SF=OF).
OF 41 /r	CMOVNO <i>r16, r/m16</i>	RM	Valid	Valid	Move if not overflow (OF=0).
OF 41 /r	CMOVNO <i>r32, r/m32</i>	RM	Valid	Valid	Move if not overflow (OF=0).
REX.W + OF 41 /r	CMOVNO <i>r64, r/m64</i>	RM	Valid	N.E.	Move if not overflow (OF=0).
OF 4B /r	CMOVNP <i>r16, r/m16</i>	RM	Valid	Valid	Move if not parity (PF=0).
OF 4B /r	CMOVNP <i>r32, r/m32</i>	RM	Valid	Valid	Move if not parity (PF=0).
REX.W + OF 4B /r	CMOVNP <i>r64, r/m64</i>	RM	Valid	N.E.	Move if not parity (PF=0).
OF 49 /r	CMOVNS <i>r16, r/m16</i>	RM	Valid	Valid	Move if not sign (SF=0).
OF 49 /r	CMOVNS <i>r32, r/m32</i>	RM	Valid	Valid	Move if not sign (SF=0).
REX.W + OF 49 /r	CMOVNS <i>r64, r/m64</i>	RM	Valid	N.E.	Move if not sign (SF=0).
OF 45 /r	CMOVNZ <i>r16, r/m16</i>	RM	Valid	Valid	Move if not zero (ZF=0).
OF 45 /r	CMOVNZ <i>r32, r/m32</i>	RM	Valid	Valid	Move if not zero (ZF=0).
REX.W + OF 45 /r	CMOVNZ <i>r64, r/m64</i>	RM	Valid	N.E.	Move if not zero (ZF=0).
OF 40 /r	CMOVO <i>r16, r/m16</i>	RM	Valid	Valid	Move if overflow (OF=1).
OF 40 /r	CMOVO <i>r32, r/m32</i>	RM	Valid	Valid	Move if overflow (OF=1).
REX.W + OF 40 /r	CMOVO <i>r64, r/m64</i>	RM	Valid	N.E.	Move if overflow (OF=1).
OF 4A /r	CMOVPP <i>r16, r/m16</i>	RM	Valid	Valid	Move if parity (PF=1).
OF 4A /r	CMOVPP <i>r32, r/m32</i>	RM	Valid	Valid	Move if parity (PF=1).
REX.W + OF 4A /r	CMOVPP <i>r64, r/m64</i>	RM	Valid	N.E.	Move if parity (PF=1).
OF 4A /r	CMOVPE <i>r16, r/m16</i>	RM	Valid	Valid	Move if parity even (PF=1).
OF 4A /r	CMOVPE <i>r32, r/m32</i>	RM	Valid	Valid	Move if parity even (PF=1).
REX.W + OF 4A /r	CMOVPE <i>r64, r/m64</i>	RM	Valid	N.E.	Move if parity even (PF=1).

Opcode	Instruction	Op/En	64-Bit Mode	Compat/Leg Mode	Description
OF 4B /r	CMOVPO r16, r/m16	RM	Valid	Valid	Move if parity odd (PF=0).
OF 4B /r	CMOVPO r32, r/m32	RM	Valid	Valid	Move if parity odd (PF=0).
REX.W + OF 4B /r	CMOVPO r64, r/m64	RM	Valid	N.E.	Move if parity odd (PF=0).
OF 48 /r	CMOVVS r16, r/m16	RM	Valid	Valid	Move if sign (SF=1).
OF 48 /r	CMOVVS r32, r/m32	RM	Valid	Valid	Move if sign (SF=1).
REX.W + OF 48 /r	CMOVVS r64, r/m64	RM	Valid	N.E.	Move if sign (SF=1).
OF 44 /r	CMOVZ r16, r/m16	RM	Valid	Valid	Move if zero (ZF=1).
OF 44 /r	CMOVZ r32, r/m32	RM	Valid	Valid	Move if zero (ZF=1).
REX.W + OF 44 /r	CMOVZ r64, r/m64	RM	Valid	N.E.	Move if zero (ZF=1).

### Instruction Operand Encoding

Op/En	Operand 1	Operand 2	Operand 3	Operand 4
RM	ModRM:reg (r, w)	ModRM:r/m (r)	NA	NA

### Description

The `CMOVcc` instructions check the state of one or more of the status flags in the EFLAGS register (CF, OF, PF, SF, and ZF) and perform a move operation if the flags are in a specified state (or condition). A condition code (*cc*) is associated with each instruction to indicate the condition being tested for. If the condition is not satisfied, a move is not performed and execution continues with the instruction following the `CMOVcc` instruction.

These instructions can move 16-bit, 32-bit or 64-bit values from memory to a general-purpose register or from one general-purpose register to another. Conditional moves of 8-bit register operands are not supported.

The condition for each `CMOVcc` mnemonic is given in the description column of the above table. The terms “less” and “greater” are used for comparisons of signed integers and the terms “above” and “below” are used for unsigned integers.

Because a particular state of the status flags can sometimes be interpreted in two ways, two mnemonics are defined for some opcodes. For example, the `CMOVA` (conditional move if above) instruction and the `CMOVNBE` (conditional move if not below or equal) instruction are alternate mnemonics for the opcode 0F 47H.

The `CMOVcc` instructions were introduced in P6 family processors; however, these instructions may not be supported by all IA-32 processors. Software can determine if the `CMOVcc` instructions are supported by checking the processor’s feature information with the `CPUID` instruction (see “`CPUID—CPU Identification`” in this chapter).

In 64-bit mode, the instruction’s default operation size is 32 bits. Use of the REX.R prefix permits access to additional registers (R8-R15). Use of the REX.W prefix promotes operation to 64 bits. See the summary chart at the beginning of this section for encoding data and limits.

### Operation

temp ← SRC

IF condition TRUE

THEN

DEST ← temp;

FI;

ELSE

IF (OperandSize = 32 and IA-32e mode active)

THEN

DEST[63:32] ← 0;

FI;

FI;

**Flags Affected**

None.

**Protected Mode Exceptions**

#GP(0)	If a memory operand effective address is outside the CS, DS, ES, FS, or GS segment limit. If the DS, ES, FS, or GS register contains a NULL segment selector.
#SS(0)	If a memory operand effective address is outside the SS segment limit.
#PF(fault-code)	If a page fault occurs.
#AC(0)	If alignment checking is enabled and an unaligned memory reference is made while the current privilege level is 3.
#UD	If the LOCK prefix is used.

**Real-Address Mode Exceptions**

#GP	If a memory operand effective address is outside the CS, DS, ES, FS, or GS segment limit.
#SS	If a memory operand effective address is outside the SS segment limit.
#UD	If the LOCK prefix is used.

**Virtual-8086 Mode Exceptions**

#GP(0)	If a memory operand effective address is outside the CS, DS, ES, FS, or GS segment limit.
#SS(0)	If a memory operand effective address is outside the SS segment limit.
#PF(fault-code)	If a page fault occurs.
#AC(0)	If alignment checking is enabled and an unaligned memory reference is made.
#UD	If the LOCK prefix is used.

**Compatibility Mode Exceptions**

Same exceptions as in protected mode.

**64-Bit Mode Exceptions**

#SS(0)	If a memory address referencing the SS segment is in a non-canonical form.
#GP(0)	If the memory address is in a non-canonical form.
#PF(fault-code)	If a page fault occurs.
#AC(0)	If alignment checking is enabled and an unaligned memory reference is made while the current privilege level is 3.
#UD	If the LOCK prefix is used.

## CMP—Compare Two Operands

Opcode	Instruction	Op/En	64-Bit Mode	Compat/Leg Mode	Description
3C <i>ib</i>	CMP AL, <i>imm8</i>	I	Valid	Valid	Compare <i>imm8</i> with AL.
3D <i>iw</i>	CMP AX, <i>imm16</i>	I	Valid	Valid	Compare <i>imm16</i> with AX.
3D <i>id</i>	CMP EAX, <i>imm32</i>	I	Valid	Valid	Compare <i>imm32</i> with EAX.
REX.W + 3D <i>id</i>	CMP RAX, <i>imm32</i>	I	Valid	N.E.	Compare <i>imm32</i> sign-extended to 64-bits with RAX.
80 /7 <i>ib</i>	CMP <i>r/m8</i> , <i>imm8</i>	MI	Valid	Valid	Compare <i>imm8</i> with <i>r/m8</i> .
REX + 80 /7 <i>ib</i>	CMP <i>r/m8</i> , <i>imm8</i>	MI	Valid	N.E.	Compare <i>imm8</i> with <i>r/m8</i> .
81 /7 <i>iw</i>	CMP <i>r/m16</i> , <i>imm16</i>	MI	Valid	Valid	Compare <i>imm16</i> with <i>r/m16</i> .
81 /7 <i>id</i>	CMP <i>r/m32</i> , <i>imm32</i>	MI	Valid	Valid	Compare <i>imm32</i> with <i>r/m32</i> .
REX.W + 81 /7 <i>id</i>	CMP <i>r/m64</i> , <i>imm32</i>	MI	Valid	N.E.	Compare <i>imm32</i> sign-extended to 64-bits with <i>r/m64</i> .
83 /7 <i>ib</i>	CMP <i>r/m16</i> , <i>imm8</i>	MI	Valid	Valid	Compare <i>imm8</i> with <i>r/m16</i> .
83 /7 <i>ib</i>	CMP <i>r/m32</i> , <i>imm8</i>	MI	Valid	Valid	Compare <i>imm8</i> with <i>r/m32</i> .
REX.W + 83 /7 <i>ib</i>	CMP <i>r/m64</i> , <i>imm8</i>	MI	Valid	N.E.	Compare <i>imm8</i> with <i>r/m64</i> .
38 /r	CMP <i>r/m8</i> , <i>r8</i>	MR	Valid	Valid	Compare <i>r8</i> with <i>r/m8</i> .
REX + 38 /r	CMP <i>r/m8</i> , <i>r8</i>	MR	Valid	N.E.	Compare <i>r8</i> with <i>r/m8</i> .
39 /r	CMP <i>r/m16</i> , <i>r16</i>	MR	Valid	Valid	Compare <i>r16</i> with <i>r/m16</i> .
39 /r	CMP <i>r/m32</i> , <i>r32</i>	MR	Valid	Valid	Compare <i>r32</i> with <i>r/m32</i> .
REX.W + 39 /r	CMP <i>r/m64</i> , <i>r64</i>	MR	Valid	N.E.	Compare <i>r64</i> with <i>r/m64</i> .
3A /r	CMP <i>r8</i> , <i>r/m8</i>	RM	Valid	Valid	Compare <i>r/m8</i> with <i>r8</i> .
REX + 3A /r	CMP <i>r8</i> , <i>r/m8</i>	RM	Valid	N.E.	Compare <i>r/m8</i> with <i>r8</i> .
3B /r	CMP <i>r16</i> , <i>r/m16</i>	RM	Valid	Valid	Compare <i>r/m16</i> with <i>r16</i> .
3B /r	CMP <i>r32</i> , <i>r/m32</i>	RM	Valid	Valid	Compare <i>r/m32</i> with <i>r32</i> .
REX.W + 3B /r	CMP <i>r64</i> , <i>r/m64</i>	RM	Valid	N.E.	Compare <i>r/m64</i> with <i>r64</i> .

### NOTES:

\* In 64-bit mode, *r/m8* can not be encoded to access the following byte registers if a REX prefix is used: AH, BH, CH, DH.

### Instruction Operand Encoding

Op/En	Operand 1	Operand 2	Operand 3	Operand 4
RM	ModRM:reg (r)	ModRM:r/m (r)	NA	NA
MR	ModRM:r/m (r)	ModRM:reg (r)	NA	NA
MI	ModRM:r/m (r)	imm8/16/32	NA	NA
I	AL/AX/EAX/RAX (r)	imm8/16/32	NA	NA

### Description

Compares the first source operand with the second source operand and sets the status flags in the EFLAGS register according to the results. The comparison is performed by subtracting the second operand from the first operand and then setting the status flags in the same manner as the SUB instruction. When an immediate value is used as an operand, it is sign-extended to the length of the first operand.

The condition codes used by the *Jcc*, *CMOVcc*, and *SETcc* instructions are based on the results of a CMP instruction. Appendix B, "EFLAGS Condition Codes," in the *Intel® 64 and IA-32 Architectures Software Developer's Manual, Volume 1*, shows the relationship of the status flags and the condition codes.



In 64-bit mode, the instruction's default operation size is 32 bits. Use of the REX.R prefix permits access to additional registers (R8-R15). Use of the REX.W prefix promotes operation to 64 bits. See the summary chart at the beginning of this section for encoding data and limits.

### Operation

temp ← SRC1 – SignExtend(SRC2);  
 ModifyStatusFlags; (\* Modify status flags in the same manner as the SUB instruction\*)

### Flags Affected

The CF, OF, SF, ZF, AF, and PF flags are set according to the result.

### Protected Mode Exceptions

#GP(0)	If a memory operand effective address is outside the CS, DS, ES, FS, or GS segment limit. If the DS, ES, FS, or GS register contains a NULL segment selector.
#SS(0)	If a memory operand effective address is outside the SS segment limit.
#PF(fault-code)	If a page fault occurs.
#AC(0)	If alignment checking is enabled and an unaligned memory reference is made while the current privilege level is 3.
#UD	If the LOCK prefix is used.

### Real-Address Mode Exceptions

#GP	If a memory operand effective address is outside the CS, DS, ES, FS, or GS segment limit.
#SS	If a memory operand effective address is outside the SS segment limit.

### Virtual-8086 Mode Exceptions

#GP(0)	If a memory operand effective address is outside the CS, DS, ES, FS, or GS segment limit.
#SS(0)	If a memory operand effective address is outside the SS segment limit.
#PF(fault-code)	If a page fault occurs.
#AC(0)	If alignment checking is enabled and an unaligned memory reference is made.
#UD	If the LOCK prefix is used.

### Compatibility Mode Exceptions

Same exceptions as in protected mode.

### 64-Bit Mode Exceptions

#SS(0)	If a memory address referencing the SS segment is in a non-canonical form.
#GP(0)	If the memory address is in a non-canonical form.
#PF(fault-code)	If a page fault occurs.
#AC(0)	If alignment checking is enabled and an unaligned memory reference is made while the current privilege level is 3.
#UD	If the LOCK prefix is used.

## CMPPD—Compare Packed Double-Precision Floating-Point Values

Opcode/ Instruction	Op / En	64/32 bit Mode Support	CPUID Feature Flag	Description
66 0F C2 /r ib CMPPD xmm1, xmm2/m128, imm8	A	V/V	SSE2	Compare packed double-precision floating-point values in xmm2/m128 and xmm1 using bits 2:0 of imm8 as a comparison predicate.
VEX.NDS.128.66.0F.WIG C2 /r ib VCMPD xmm1, xmm2, xmm3/m128, imm8	B	V/V	AVX	Compare packed double-precision floating-point values in xmm3/m128 and xmm2 using bits 4:0 of imm8 as a comparison predicate.
VEX.NDS.256.66.0F.WIG C2 /r ib VCMPD ymm1, ymm2, ymm3/m256, imm8	B	V/V	AVX	Compare packed double-precision floating-point values in ymm3/m256 and ymm2 using bits 4:0 of imm8 as a comparison predicate.
EVEX.NDS.128.66.0F.W1 C2 /r ib VCMPD k1 {k2}, xmm2, xmm3/m128/m64bcst, imm8	C	V/V	AVX512VL AVX512F	Compare packed double-precision floating-point values in xmm3/m128/m64bcst and xmm2 using bits 4:0 of imm8 as a comparison predicate with writemask k2 and leave the result in mask register k1.
EVEX.NDS.256.66.0F.W1 C2 /r ib VCMPD k1 {k2}, ymm2, ymm3/m256/m64bcst, imm8	C	V/V	AVX512VL AVX512F	Compare packed double-precision floating-point values in ymm3/m256/m64bcst and ymm2 using bits 4:0 of imm8 as a comparison predicate with writemask k2 and leave the result in mask register k1.
EVEX.NDS.512.66.0F.W1 C2 /r ib VCMPD k1 {k2}, zmm2, zmm3/m512/m64bcst{sae}, imm8	C	V/V	AVX512F	Compare packed double-precision floating-point values in zmm3/m512/m64bcst and zmm2 using bits 4:0 of imm8 as a comparison predicate with writemask k2 and leave the result in mask register k1.

### Instruction Operand Encoding

Op/En	Tuple Type	Operand 1	Operand 2	Operand 3	Operand 4
A	NA	ModRM:reg (r, w)	ModRM:r/m (r)	Imm8	NA
B	NA	ModRM:reg (w)	VEX.vvvv	ModRM:r/m (r)	Imm8
C	Full	ModRM:reg (w)	EVEX.vvvv	ModRM:r/m (r)	Imm8

### Description

Performs a SIMD compare of the packed double-precision floating-point values in the second source operand and the first source operand and returns the results of the comparison to the destination operand. The comparison predicate operand (immediate byte) specifies the type of comparison performed on each pair of packed values in the two source operands.

EVEX encoded versions: The first source operand (second operand) is a ZMM/YMM/XMM register. The second source operand can be a ZMM/YMM/XMM register, a 512/256/128-bit memory location or a 512/256/128-bit vector broadcasted from a 64-bit memory location. The destination operand (first operand) is an opmask register. Comparison results are written to the destination operand under the writemask k2. Each comparison result is a single mask bit of 1 (comparison true) or 0 (comparison false).

VEX.256 encoded version: The first source operand (second operand) is a YMM register. The second source operand (third operand) can be a YMM register or a 256-bit memory location. The destination operand (first operand) is a YMM register. Four comparisons are performed with results written to the destination operand. The result of each comparison is a quadword mask of all 1s (comparison true) or all 0s (comparison false).

128-bit Legacy SSE version: The first source and destination operand (first operand) is an XMM register. The second source operand (second operand) can be an XMM register or 128-bit memory location. Bits (MAXVL-1:128) of the corresponding ZMM destination register remain unchanged. Two comparisons are performed with results written to bits 127:0 of the destination operand. The result of each comparison is a quadword mask of all 1s (comparison true) or all 0s (comparison false).

VEX.128 encoded version: The first source operand (second operand) is an XMM register. The second source operand (third operand) can be an XMM register or a 128-bit memory location. Bits (MAXVL-1:128) of the destination ZMM register are zeroed. Two comparisons are performed with results written to bits 127:0 of the destination operand.

The comparison predicate operand is an 8-bit immediate:

- For instructions encoded using the VEX or EVEX prefix, bits 4:0 define the type of comparison to be performed (see Table 3-1). Bits 5 through 7 of the immediate are reserved.
- For instruction encodings that do not use VEX prefix, bits 2:0 define the type of comparison to be made (see the first 8 rows of Table 3-1). Bits 3 through 7 of the immediate are reserved.

**Table 3-1. Comparison Predicate for CMPDD and CMPPS Instructions**

Predicate	imm8 Value	Description	Result: A Is 1st Operand, B Is 2nd Operand				Signals #IA on QNAN
			A > B	A < B	A = B	Unordered <sup>1</sup>	
EQ_OQ (EQ)	0H	Equal (ordered, non-signaling)	False	False	True	False	No
LT_OS (LT)	1H	Less-than (ordered, signaling)	False	True	False	False	Yes
LE_OS (LE)	2H	Less-than-or-equal (ordered, signaling)	False	True	True	False	Yes
UNORD_Q (UNORD)	3H	Unordered (non-signaling)	False	False	False	True	No
NEQ_UQ (NEQ)	4H	Not-equal (unordered, non-signaling)	True	True	False	True	No
NLT_US (NLT)	5H	Not-less-than (unordered, signaling)	True	False	True	True	Yes
NLE_US (NLE)	6H	Not-less-than-or-equal (unordered, signaling)	True	False	False	True	Yes
ORD_Q (ORD)	7H	Ordered (non-signaling)	True	True	True	False	No
EQ_UQ	8H	Equal (unordered, non-signaling)	False	False	True	True	No
NGE_US (NGE)	9H	Not-greater-than-or-equal (unordered, signaling)	False	True	False	True	Yes
NGT_US (NGT)	AH	Not-greater-than (unordered, signaling)	False	True	True	True	Yes
FALSE_OQ (FALSE)	BH	False (ordered, non-signaling)	False	False	False	False	No
NEQ_OQ	CH	Not-equal (ordered, non-signaling)	True	True	False	False	No
GE_OS (GE)	DH	Greater-than-or-equal (ordered, signaling)	True	False	True	False	Yes
GT_OS (GT)	EH	Greater-than (ordered, signaling)	True	False	False	False	Yes
TRUE_UQ (TRUE)	FH	True (unordered, non-signaling)	True	True	True	True	No
EQ_OS	10H	Equal (ordered, signaling)	False	False	True	False	Yes
LT_OQ	11H	Less-than (ordered, nonsignaling)	False	True	False	False	No
LE_OQ	12H	Less-than-or-equal (ordered, nonsignaling)	False	True	True	False	No
UNORD_S	13H	Unordered (signaling)	False	False	False	True	Yes
NEQ_US	14H	Not-equal (unordered, signaling)	True	True	False	True	Yes
NLT_UQ	15H	Not-less-than (unordered, nonsignaling)	True	False	True	True	No
NLE_UQ	16H	Not-less-than-or-equal (unordered, nonsignaling)	True	False	False	True	No
ORD_S	17H	Ordered (signaling)	True	True	True	False	Yes
EQ_US	18H	Equal (unordered, signaling)	False	False	True	True	Yes
NGE_UQ	19H	Not-greater-than-or-equal (unordered, non-signaling)	False	True	False	True	No

**Table 3-1. Comparison Predicate for CMPPD and CMPPS Instructions (Contd.)**

Predicate	imm8 Value	Description	Result: A Is 1st Operand, B Is 2nd Operand				Signals #IA on QNaN
			A > B	A < B	A = B	Unordered <sup>1</sup>	
NGT_UQ	1AH	Not-greater-than (unordered, nonsignaling)	False	True	True	True	No
FALSE_OS	1BH	False (ordered, signaling)	False	False	False	False	Yes
NEQ_OS	1CH	Not-equal (ordered, signaling)	True	True	False	False	Yes
GE_OQ	1DH	Greater-than-or-equal (ordered, nonsignaling)	True	False	True	False	No
GT_OQ	1EH	Greater-than (ordered, nonsignaling)	True	False	False	False	No
TRUE_US	1FH	True (unordered, signaling)	True	True	True	True	Yes

**NOTES:**

1. If either operand A or B is a NaN.

The unordered relationship is true when at least one of the two source operands being compared is a NaN; the ordered relationship is true when neither source operand is a NaN.

A subsequent computational instruction that uses the mask result in the destination operand as an input operand will not generate an exception, because a mask of all 0s corresponds to a floating-point value of +0.0 and a mask of all 1s corresponds to a QNaN.

Note that processors with "CPUID.1H:ECX.AVX = 0" do not implement the "greater-than", "greater-than-or-equal", "not-greater than", and "not-greater-than-or-equal relations" predicates. These comparisons can be made either by using the inverse relationship (that is, use the "not-less-than-or-equal" to make a "greater-than" comparison) or by using software emulation. When using software emulation, the program must swap the operands (copying registers when necessary to protect the data that will now be in the destination), and then perform the compare using a different predicate. The predicate to be used for these emulations is listed in the first 8 rows of Table 3-7 (*Intel 64 and IA-32 Architectures Software Developer's Manual Volume 2A*) under the heading Emulation.

Compilers and assemblers may implement the following two-operand pseudo-ops in addition to the three-operand CMPPD instruction, for processors with "CPUID.1H:ECX.AVX = 0". See Table 3-2. Compiler should treat reserved Imm8 values as illegal syntax.

**Table 3-2. Pseudo-Op and CMPPD Implementation**

Pseudo-Op	CMPPD Implementation
CMPEQPD <i>xmm1, xmm2</i>	CMPPD <i>xmm1, xmm2, 0</i>
CMPLTPD <i>xmm1, xmm2</i>	CMPPD <i>xmm1, xmm2, 1</i>
CMPLEPD <i>xmm1, xmm2</i>	CMPPD <i>xmm1, xmm2, 2</i>
CMPUNORDPD <i>xmm1, xmm2</i>	CMPPD <i>xmm1, xmm2, 3</i>
CMPNEQPD <i>xmm1, xmm2</i>	CMPPD <i>xmm1, xmm2, 4</i>
CMPNLTPD <i>xmm1, xmm2</i>	CMPPD <i>xmm1, xmm2, 5</i>
CMPNLEPD <i>xmm1, xmm2</i>	CMPPD <i>xmm1, xmm2, 6</i>
CMPORDPD <i>xmm1, xmm2</i>	CMPPD <i>xmm1, xmm2, 7</i>

The greater-than relations that the processor does not implement require more than one instruction to emulate in software and therefore should not be implemented as pseudo-ops. (For these, the programmer should reverse the operands of the corresponding less than relations and use move instructions to ensure that the mask is moved to the correct destination register and that the source operand is left intact.)

Processors with "CPUID.1H:ECX.AVX = 1" implement the full complement of 32 predicates shown in Table 3-3, software emulation is no longer needed. Compilers and assemblers may implement the following three-operand pseudo-ops in addition to the four-operand VCMPPD instruction. See Table 3-3, where the notations of reg1 reg2, and reg3 represent either XMM registers or YMM registers. Compiler should treat reserved Imm8 values as illegal



**Operation**

CASE (COMPARISON PREDICATE) OF

0: OP3  $\leftarrow$  EQ\_OQ; OP5  $\leftarrow$  EQ\_OQ;  
 1: OP3  $\leftarrow$  LT\_OS; OP5  $\leftarrow$  LT\_OS;  
 2: OP3  $\leftarrow$  LE\_OS; OP5  $\leftarrow$  LE\_OS;  
 3: OP3  $\leftarrow$  UNORD\_Q; OP5  $\leftarrow$  UNORD\_Q;  
 4: OP3  $\leftarrow$  NEQ\_UQ; OP5  $\leftarrow$  NEQ\_UQ;  
 5: OP3  $\leftarrow$  NLT\_US; OP5  $\leftarrow$  NLT\_US;  
 6: OP3  $\leftarrow$  NLE\_US; OP5  $\leftarrow$  NLE\_US;  
 7: OP3  $\leftarrow$  ORD\_Q; OP5  $\leftarrow$  ORD\_Q;  
 8: OP5  $\leftarrow$  EQ\_UQ;  
 9: OP5  $\leftarrow$  NGE\_US;  
 10: OP5  $\leftarrow$  NGT\_US;  
 11: OP5  $\leftarrow$  FALSE\_OQ;  
 12: OP5  $\leftarrow$  NEQ\_OQ;  
 13: OP5  $\leftarrow$  GE\_OS;  
 14: OP5  $\leftarrow$  GT\_OS;  
 15: OP5  $\leftarrow$  TRUE\_UQ;  
 16: OP5  $\leftarrow$  EQ\_OS;  
 17: OP5  $\leftarrow$  LT\_OQ;  
 18: OP5  $\leftarrow$  LE\_OQ;  
 19: OP5  $\leftarrow$  UNORD\_S;  
 20: OP5  $\leftarrow$  NEQ\_US;  
 21: OP5  $\leftarrow$  NLT\_UQ;  
 22: OP5  $\leftarrow$  NLE\_UQ;  
 23: OP5  $\leftarrow$  ORD\_S;  
 24: OP5  $\leftarrow$  EQ\_US;  
 25: OP5  $\leftarrow$  NGE\_UQ;  
 26: OP5  $\leftarrow$  NGT\_UQ;  
 27: OP5  $\leftarrow$  FALSE\_OS;  
 28: OP5  $\leftarrow$  NEQ\_OS;  
 29: OP5  $\leftarrow$  GE\_OQ;  
 30: OP5  $\leftarrow$  GT\_OQ;  
 31: OP5  $\leftarrow$  TRUE\_US;  
 DEFAULT: Reserved;  
 ESAC;

**VCMPD (EVEX encoded versions)**

(KL, VL) = (2, 128), (4, 256), (8, 512)

FOR j ← 0 TO KL-1

i ← j \* 64

IF k2[j] OR \*no writemask\*

THEN

IF (EVEX.b = 1) AND (SRC2 \*is memory\*)

THEN

CMP ← SRC1[i+63:i] OP5 SRC2[63:0]

ELSE

CMP ← SRC1[i+63:i] OP5 SRC2[j+63:i]

FI;

IF CMP = TRUE

THEN DEST[j] ← 1;

ELSE DEST[j] ← 0; FI;

ELSE DEST[j] ← 0 ; zeroing-masking only

FI;

ENDFOR

DEST[MAX\_KL-1:KL] ← 0

**VCMPD (VEX.256 encoded version)**

CMP0 ← SRC1[63:0] OP5 SRC2[63:0];

CMP1 ← SRC1[127:64] OP5 SRC2[127:64];

CMP2 ← SRC1[191:128] OP5 SRC2[191:128];

CMP3 ← SRC1[255:192] OP5 SRC2[255:192];

IF CMP0 = TRUE

THEN DEST[63:0] ← FFFFFFFFFFFFFFFFH;

ELSE DEST[63:0] ← 0000000000000000H; FI;

IF CMP1 = TRUE

THEN DEST[127:64] ← FFFFFFFFFFFFFFFFH;

ELSE DEST[127:64] ← 0000000000000000H; FI;

IF CMP2 = TRUE

THEN DEST[191:128] ← FFFFFFFFFFFFFFFFH;

ELSE DEST[191:128] ← 0000000000000000H; FI;

IF CMP3 = TRUE

THEN DEST[255:192] ← FFFFFFFFFFFFFFFFH;

ELSE DEST[255:192] ← 0000000000000000H; FI;

DEST[MAXVL-1:256] ← 0

**VCMPD (VEX.128 encoded version)**

CMP0 ← SRC1[63:0] OP5 SRC2[63:0];

CMP1 ← SRC1[127:64] OP5 SRC2[127:64];

IF CMP0 = TRUE

THEN DEST[63:0] ← FFFFFFFFFFFFFFFFH;

ELSE DEST[63:0] ← 0000000000000000H; FI;

IF CMP1 = TRUE

THEN DEST[127:64] ← FFFFFFFFFFFFFFFFH;

ELSE DEST[127:64] ← 0000000000000000H; FI;

DEST[MAXVL-1:128] ← 0

**CMPPD (128-bit Legacy SSE version)**

```

CMP0 ← SRC1[63:0] OP3 SRC2[63:0];
CMP1 ← SRC1[127:64] OP3 SRC2[127:64];
IF CMP0 = TRUE
    THEN DEST[63:0] ← FFFFFFFFFFFFFFFFH;
    ELSE DEST[63:0] ← 0000000000000000H; FI;
IF CMP1 = TRUE
    THEN DEST[127:64] ← FFFFFFFFFFFFFFFFH;
    ELSE DEST[127:64] ← 0000000000000000H; FI;
DEST[MAXVL-1:128] (Unmodified)

```

**Intel C/C++ Compiler Intrinsic Equivalent**

```

VCMPD __mmask8 __mm512_cmp_pd_mask( __m512d a, __m512d b, int imm);
VCMPD __mmask8 __mm512_cmp_round_pd_mask( __m512d a, __m512d b, int imm, int sae);
VCMPD __mmask8 __mm512_mask_cmp_pd_mask( __mmask8 k1, __m512d a, __m512d b, int imm);
VCMPD __mmask8 __mm512_mask_cmp_round_pd_mask( __mmask8 k1, __m512d a, __m512d b, int imm, int sae);
VCMPD __mmask8 __mm256_cmp_pd_mask( __m256d a, __m256d b, int imm);
VCMPD __mmask8 __mm256_mask_cmp_pd_mask( __mmask8 k1, __m256d a, __m256d b, int imm);
VCMPD __mmask8 __mm_cmp_pd_mask( __m128d a, __m128d b, int imm);
VCMPD __mmask8 __mm_mask_cmp_pd_mask( __mmask8 k1, __m128d a, __m128d b, int imm);
VCMPD __m256 __mm256_cmp_pd(__m256d a, __m256d b, int imm)
(V)VCMPD __m128 __mm_cmp_pd(__m128d a, __m128d b, int imm)

```

**SIMD Floating-Point Exceptions**

Invalid if SNaN operand and invalid if QNaN and predicate as listed in Table 3-1.

Denormal

**Other Exceptions**

VEX-encoded instructions, see Exceptions Type 2.

EVEX-encoded instructions, see Exceptions Type E2.



## CMPPS—Compare Packed Single-Precision Floating-Point Values

Opcode/ Instruction	Op / En	64/32 bit Mode Support	CPUID Feature Flag	Description
NP OF C2 /r ib CMPPS xmm1, xmm2/m128, imm8	A	V/V	SSE	Compare packed single-precision floating-point values in xmm2/m128 and xmm1 using bits 2:0 of imm8 as a comparison predicate.
VEX.NDS.128.OF.WIG C2 /r ib VCMPPS xmm1, xmm2, xmm3/m128, imm8	B	V/V	AVX	Compare packed single-precision floating-point values in xmm3/m128 and xmm2 using bits 4:0 of imm8 as a comparison predicate.
VEX.NDS.256.OF.WIG C2 /r ib VCMPPS ymm1, ymm2, ymm3/m256, imm8	B	V/V	AVX	Compare packed single-precision floating-point values in ymm3/m256 and ymm2 using bits 4:0 of imm8 as a comparison predicate.
EVEX.NDS.128.OF.WO C2 /r ib VCMPPS k1 {k2}, xmm2, xmm3/m128/m32bcst, imm8	C	V/V	AVX512VL AVX512F	Compare packed single-precision floating-point values in xmm3/m128/m32bcst and xmm2 using bits 4:0 of imm8 as a comparison predicate with writemask k2 and leave the result in mask register k1.
EVEX.NDS.256.OF.WO C2 /r ib VCMPPS k1 {k2}, ymm2, ymm3/m256/m32bcst, imm8	C	V/V	AVX512VL AVX512F	Compare packed single-precision floating-point values in ymm3/m256/m32bcst and ymm2 using bits 4:0 of imm8 as a comparison predicate with writemask k2 and leave the result in mask register k1.
EVEX.NDS.512.OF.WO C2 /r ib VCMPPS k1 {k2}, zmm2, zmm3/m512/m32bcst{sae}, imm8	C	V/V	AVX512F	Compare packed single-precision floating-point values in zmm3/m512/m32bcst and zmm2 using bits 4:0 of imm8 as a comparison predicate with writemask k2 and leave the result in mask register k1.

### Instruction Operand Encoding

Op/En	Tuple Type	Operand 1	Operand 2	Operand 3	Operand 4
A	NA	ModRM:reg (r, w)	ModRM:r/m (r)	Imm8	NA
B	NA	ModRM:reg (w)	VEX.vvvv	ModRM:r/m (r)	Imm8
C	Full	ModRM:reg (w)	EVEX.vvvv	ModRM:r/m (r)	Imm8

### Description

Performs a SIMD compare of the packed single-precision floating-point values in the second source operand and the first source operand and returns the results of the comparison to the destination operand. The comparison predicate operand (immediate byte) specifies the type of comparison performed on each of the pairs of packed values.

EVEX encoded versions: The first source operand (second operand) is a ZMM/YMM/XMM register. The second source operand can be a ZMM/YMM/XMM register, a 512/256/128-bit memory location or a 512/256/128-bit vector broadcasted from a 32-bit memory location. The destination operand (first operand) is an opmask register. Comparison results are written to the destination operand under the writemask k2. Each comparison result is a single mask bit of 1 (comparison true) or 0 (comparison false).

VEX.256 encoded version: The first source operand (second operand) is a YMM register. The second source operand (third operand) can be a YMM register or a 256-bit memory location. The destination operand (first operand) is a YMM register. Eight comparisons are performed with results written to the destination operand. The result of each comparison is a doubleword mask of all 1s (comparison true) or all 0s (comparison false).

128-bit Legacy SSE version: The first source and destination operand (first operand) is an XMM register. The second source operand (second operand) can be an XMM register or 128-bit memory location. Bits (MAXVL-1:128) of the corresponding ZMM destination register remain unchanged. Four comparisons are performed with results written to bits 127:0 of the destination operand. The result of each comparison is a doubleword mask of all 1s (comparison true) or all 0s (comparison false).

VEX.128 encoded version: The first source operand (second operand) is an XMM register. The second source operand (third operand) can be an XMM register or a 128-bit memory location. Bits (MAXVL-1:128) of the destination ZMM register are zeroed. Four comparisons are performed with results written to bits 127:0 of the destination operand.

The comparison predicate operand is an 8-bit immediate:

- For instructions encoded using the VEX prefix and EVEX prefix, bits 4:0 define the type of comparison to be performed (see Table 3-1). Bits 5 through 7 of the immediate are reserved.
- For instruction encodings that do not use VEX prefix, bits 2:0 define the type of comparison to be made (see the first 8 rows of Table 3-1). Bits 3 through 7 of the immediate are reserved.

The unordered relationship is true when at least one of the two source operands being compared is a NaN; the ordered relationship is true when neither source operand is a NaN.

A subsequent computational instruction that uses the mask result in the destination operand as an input operand will not generate an exception, because a mask of all 0s corresponds to a floating-point value of +0.0 and a mask of all 1s corresponds to a QNaN.

Note that processors with "CPUID.1H:ECX.AVX = 0" do not implement the "greater-than", "greater-than-or-equal", "not-greater than", and "not-greater-than-or-equal" predicates. These comparisons can be made either by using the inverse relationship (that is, use the "not-less-than-or-equal" to make a "greater-than" comparison) or by using software emulation. When using software emulation, the program must swap the operands (copying registers when necessary to protect the data that will now be in the destination), and then perform the compare using a different predicate. The predicate to be used for these emulations is listed in the first 8 rows of Table 3-7 (*Intel 64 and IA-32 Architectures Software Developer's Manual Volume 2A*) under the heading Emulation.

Compilers and assemblers may implement the following two-operand pseudo-ops in addition to the three-operand CMPPS instruction, for processors with "CPUID.1H:ECX.AVX = 0". See Table 3-4. Compiler should treat reserved Imm8 values as illegal syntax.

**Table 3-4. Pseudo-Op and CMPPS Implementation**

Pseudo-Op	CMPPS Implementation
CMPEQPS <i>xmm1, xmm2</i>	CMPPS <i>xmm1, xmm2, 0</i>
CMPLTPS <i>xmm1, xmm2</i>	CMPPS <i>xmm1, xmm2, 1</i>
CMPLEPS <i>xmm1, xmm2</i>	CMPPS <i>xmm1, xmm2, 2</i>
CMPUNORDPS <i>xmm1, xmm2</i>	CMPPS <i>xmm1, xmm2, 3</i>
CMPNEQPS <i>xmm1, xmm2</i>	CMPPS <i>xmm1, xmm2, 4</i>
CMPNLTPS <i>xmm1, xmm2</i>	CMPPS <i>xmm1, xmm2, 5</i>
CMPNLEPS <i>xmm1, xmm2</i>	CMPPS <i>xmm1, xmm2, 6</i>
CMPORDPS <i>xmm1, xmm2</i>	CMPPS <i>xmm1, xmm2, 7</i>

The greater-than relations that the processor does not implement require more than one instruction to emulate in software and therefore should not be implemented as pseudo-ops. (For these, the programmer should reverse the operands of the corresponding less than relations and use move instructions to ensure that the mask is moved to the correct destination register and that the source operand is left intact.)

Processors with "CPUID.1H:ECX.AVX = 1" implement the full complement of 32 predicates shown in Table 3-5, software emulation is no longer needed. Compilers and assemblers may implement the following three-operand pseudo-ops in addition to the four-operand VCMPPS instruction. See Table 3-5, where the notation of reg1 and reg2 represent either XMM registers or YMM registers. Compiler should treat reserved Imm8 values as illegal syntax. Alternately, intrinsics can map the pseudo-ops to pre-defined constants to support a simpler intrinsic interface. Compilers and assemblers may implement three-operand pseudo-ops for EVEX encoded VCMPPS instructions in a similar fashion by extending the syntax listed in Table 3-5.

Table 3-5. Pseudo-Op and VCMPPS Implementation

Pseudo-Op	CMPPS Implementation
VCMPEQPS <i>reg1, reg2, reg3</i>	VCMPPS <i>reg1, reg2, reg3, 0</i>
VCMPLTPS <i>reg1, reg2, reg3</i>	VCMPPS <i>reg1, reg2, reg3, 1</i>
VCMPLLEPS <i>reg1, reg2, reg3</i>	VCMPPS <i>reg1, reg2, reg3, 2</i>
VCMPLNORDPS <i>reg1, reg2, reg3</i>	VCMPPS <i>reg1, reg2, reg3, 3</i>
VCMPLNEQPS <i>reg1, reg2, reg3</i>	VCMPPS <i>reg1, reg2, reg3, 4</i>
VCMPLNLTPS <i>reg1, reg2, reg3</i>	VCMPPS <i>reg1, reg2, reg3, 5</i>
VCMPLNLEPS <i>reg1, reg2, reg3</i>	VCMPPS <i>reg1, reg2, reg3, 6</i>
VCMPLORDPS <i>reg1, reg2, reg3</i>	VCMPPS <i>reg1, reg2, reg3, 7</i>
VCMPEQ_UQPS <i>reg1, reg2, reg3</i>	VCMPPS <i>reg1, reg2, reg3, 8</i>
VCMPLNGEPS <i>reg1, reg2, reg3</i>	VCMPPS <i>reg1, reg2, reg3, 9</i>
VCMPLNGTPS <i>reg1, reg2, reg3</i>	VCMPPS <i>reg1, reg2, reg3, 0AH</i>
VCMPLFALSEPS <i>reg1, reg2, reg3</i>	VCMPPS <i>reg1, reg2, reg3, 0BH</i>
VCMPLNEQ_OQPS <i>reg1, reg2, reg3</i>	VCMPPS <i>reg1, reg2, reg3, 0CH</i>
VCMPLGEPSPS <i>reg1, reg2, reg3</i>	VCMPPS <i>reg1, reg2, reg3, 0DH</i>
VCMPLGTSPS <i>reg1, reg2, reg3</i>	VCMPPS <i>reg1, reg2, reg3, 0EH</i>
VCMPLTRUEPS <i>reg1, reg2, reg3</i>	VCMPPS <i>reg1, reg2, reg3, 0FH</i>
VCMPEQ_OSPS <i>reg1, reg2, reg3</i>	VCMPPS <i>reg1, reg2, reg3, 10H</i>
VCMPLT_OQPS <i>reg1, reg2, reg3</i>	VCMPPS <i>reg1, reg2, reg3, 11H</i>
VCMPLLE_OQPS <i>reg1, reg2, reg3</i>	VCMPPS <i>reg1, reg2, reg3, 12H</i>
VCMPLNORD_SPS <i>reg1, reg2, reg3</i>	VCMPPS <i>reg1, reg2, reg3, 13H</i>
VCMPLNEQ_USPS <i>reg1, reg2, reg3</i>	VCMPPS <i>reg1, reg2, reg3, 14H</i>
VCMPLNLT_UQPS <i>reg1, reg2, reg3</i>	VCMPPS <i>reg1, reg2, reg3, 15H</i>
VCMPLNLE_UQPS <i>reg1, reg2, reg3</i>	VCMPPS <i>reg1, reg2, reg3, 16H</i>
VCMPLORD_SPS <i>reg1, reg2, reg3</i>	VCMPPS <i>reg1, reg2, reg3, 17H</i>
VCMPEQ_USPS <i>reg1, reg2, reg3</i>	VCMPPS <i>reg1, reg2, reg3, 18H</i>
VCMPLNGE_UQPS <i>reg1, reg2, reg3</i>	VCMPPS <i>reg1, reg2, reg3, 19H</i>
VCMPLNGT_UQPS <i>reg1, reg2, reg3</i>	VCMPPS <i>reg1, reg2, reg3, 1AH</i>
VCMPLFALSE_OSPS <i>reg1, reg2, reg3</i>	VCMPPS <i>reg1, reg2, reg3, 1BH</i>
VCMPLNEQ_OSPS <i>reg1, reg2, reg3</i>	VCMPPS <i>reg1, reg2, reg3, 1CH</i>
VCMPLGE_OQPS <i>reg1, reg2, reg3</i>	VCMPPS <i>reg1, reg2, reg3, 1DH</i>
VCMPLGT_OQPS <i>reg1, reg2, reg3</i>	VCMPPS <i>reg1, reg2, reg3, 1EH</i>
VCMPLTRUE_USPS <i>reg1, reg2, reg3</i>	VCMPPS <i>reg1, reg2, reg3, 1FH</i>

**Operation**

CASE (COMPARISON PREDICATE) OF  
 0: OP3  $\leftarrow$  EQ\_OQ; OP5  $\leftarrow$  EQ\_OQ;  
 1: OP3  $\leftarrow$  LT\_OS; OP5  $\leftarrow$  LT\_OS;  
 2: OP3  $\leftarrow$  LE\_OS; OP5  $\leftarrow$  LE\_OS;  
 3: OP3  $\leftarrow$  UNORD\_Q; OP5  $\leftarrow$  UNORD\_Q;  
 4: OP3  $\leftarrow$  NEQ\_UQ; OP5  $\leftarrow$  NEQ\_UQ;  
 5: OP3  $\leftarrow$  NLT\_US; OP5  $\leftarrow$  NLT\_US;  
 6: OP3  $\leftarrow$  NLE\_US; OP5  $\leftarrow$  NLE\_US;  
 7: OP3  $\leftarrow$  ORD\_Q; OP5  $\leftarrow$  ORD\_Q;  
 8: OP5  $\leftarrow$  EQ\_UQ;  
 9: OP5  $\leftarrow$  NGE\_US;  
 10: OP5  $\leftarrow$  NGT\_US;  
 11: OP5  $\leftarrow$  FALSE\_OQ;  
 12: OP5  $\leftarrow$  NEQ\_OQ;  
 13: OP5  $\leftarrow$  GE\_OS;  
 14: OP5  $\leftarrow$  GT\_OS;  
 15: OP5  $\leftarrow$  TRUE\_UQ;  
 16: OP5  $\leftarrow$  EQ\_OS;  
 17: OP5  $\leftarrow$  LT\_OQ;  
 18: OP5  $\leftarrow$  LE\_OQ;  
 19: OP5  $\leftarrow$  UNORD\_S;  
 20: OP5  $\leftarrow$  NEQ\_US;  
 21: OP5  $\leftarrow$  NLT\_UQ;  
 22: OP5  $\leftarrow$  NLE\_UQ;  
 23: OP5  $\leftarrow$  ORD\_S;  
 24: OP5  $\leftarrow$  EQ\_US;  
 25: OP5  $\leftarrow$  NGE\_UQ;  
 26: OP5  $\leftarrow$  NGT\_UQ;  
 27: OP5  $\leftarrow$  FALSE\_OS;  
 28: OP5  $\leftarrow$  NEQ\_OS;  
 29: OP5  $\leftarrow$  GE\_OQ;  
 30: OP5  $\leftarrow$  GT\_OQ;  
 31: OP5  $\leftarrow$  TRUE\_US;  
 DEFAULT: Reserved  
 ESAC;

**VCMPSS (EVEX encoded versions)**

(KL, VL) = (4, 128), (8, 256), (16, 512)

FOR j ← 0 TO KL-1

i ← j \* 32

IF k2[j] OR \*no writemask\*

THEN

IF (EVEX.b = 1) AND (SRC2 \*is memory\*)

THEN

CMP ← SRC1[i+31:i] OP5 SRC2[31:0]

ELSE

CMP ← SRC1[i+31:i] OP5 SRC2[j+31:i]

FI;

IF CMP = TRUE

THEN DEST[j] ← 1;

ELSE DEST[j] ← 0; FI;

ELSE DEST[j] ← 0 ; zeroing-masking only FI;

FI;

ENDFOR

DEST[MAX\_KL-1:KL] ← 0

**VCMPSS (VEX.256 encoded version)**

CMP0 ← SRC1[31:0] OP5 SRC2[31:0];

CMP1 ← SRC1[63:32] OP5 SRC2[63:32];

CMP2 ← SRC1[95:64] OP5 SRC2[95:64];

CMP3 ← SRC1[127:96] OP5 SRC2[127:96];

CMP4 ← SRC1[159:128] OP5 SRC2[159:128];

CMP5 ← SRC1[191:160] OP5 SRC2[191:160];

CMP6 ← SRC1[223:192] OP5 SRC2[223:192];

CMP7 ← SRC1[255:224] OP5 SRC2[255:224];

IF CMP0 = TRUE

THEN DEST[31:0] ← FFFFFFFFH;

ELSE DEST[31:0] ← 00000000H; FI;

IF CMP1 = TRUE

THEN DEST[63:32] ← FFFFFFFFH;

ELSE DEST[63:32] ← 00000000H; FI;

IF CMP2 = TRUE

THEN DEST[95:64] ← FFFFFFFFH;

ELSE DEST[95:64] ← 00000000H; FI;

IF CMP3 = TRUE

THEN DEST[127:96] ← FFFFFFFFH;

ELSE DEST[127:96] ← 00000000H; FI;

IF CMP4 = TRUE

THEN DEST[159:128] ← FFFFFFFFH;

ELSE DEST[159:128] ← 00000000H; FI;

IF CMP5 = TRUE

THEN DEST[191:160] ← FFFFFFFFH;

ELSE DEST[191:160] ← 00000000H; FI;

IF CMP6 = TRUE

THEN DEST[223:192] ← FFFFFFFFH;

ELSE DEST[223:192] ← 00000000H; FI;

IF CMP7 = TRUE

THEN DEST[255:224] ← FFFFFFFFH;

ELSE DEST[255:224] ← 00000000H; FI;

DEST[MAXVL-1:256] ← 0

**VCMPSS (VEX.128 encoded version)**

```

CMP0 ← SRC1[31:0] OP5 SRC2[31:0];
CMP1 ← SRC1[63:32] OP5 SRC2[63:32];
CMP2 ← SRC1[95:64] OP5 SRC2[95:64];
CMP3 ← SRC1[127:96] OP5 SRC2[127:96];
IF CMP0 = TRUE
    THEN DEST[31:0] ← FFFFFFFFH;
    ELSE DEST[31:0] ← 00000000H; FI;
IF CMP1 = TRUE
    THEN DEST[63:32] ← FFFFFFFFH;
    ELSE DEST[63:32] ← 00000000H; FI;
IF CMP2 = TRUE
    THEN DEST[95:64] ← FFFFFFFFH;
    ELSE DEST[95:64] ← 00000000H; FI;
IF CMP3 = TRUE
    THEN DEST[127:96] ← FFFFFFFFH;
    ELSE DEST[127:96] ← 00000000H; FI;
DEST[MAXVL-1:128] ← 0

```

**CMPPS (128-bit Legacy SSE version)**

```

CMP0 ← SRC1[31:0] OP3 SRC2[31:0];
CMP1 ← SRC1[63:32] OP3 SRC2[63:32];
CMP2 ← SRC1[95:64] OP3 SRC2[95:64];
CMP3 ← SRC1[127:96] OP3 SRC2[127:96];
IF CMP0 = TRUE
    THEN DEST[31:0] ← FFFFFFFFH;
    ELSE DEST[31:0] ← 00000000H; FI;
IF CMP1 = TRUE
    THEN DEST[63:32] ← FFFFFFFFH;
    ELSE DEST[63:32] ← 00000000H; FI;
IF CMP2 = TRUE
    THEN DEST[95:64] ← FFFFFFFFH;
    ELSE DEST[95:64] ← 00000000H; FI;
IF CMP3 = TRUE
    THEN DEST[127:96] ← FFFFFFFFH;
    ELSE DEST[127:96] ← 00000000H; FI;
DEST[MAXVL-1:128] (Unmodified)

```

**Intel C/C++ Compiler Intrinsic Equivalent**

```

VCMPSS __mmask16 __mm512_cmp_ps_mask( __m512 a, __m512 b, int imm);
VCMPSS __mmask16 __mm512_cmp_round_ps_mask( __m512 a, __m512 b, int imm, int sae);
VCMPSS __mmask16 __mm512_mask_cmp_ps_mask( __mmask16 k1, __m512 a, __m512 b, int imm);
VCMPSS __mmask16 __mm512_mask_cmp_round_ps_mask( __mmask16 k1, __m512 a, __m512 b, int imm, int sae);
VCMPSS __mmask8 __mm256_cmp_ps_mask( __m256 a, __m256 b, int imm);
VCMPSS __mmask8 __mm256_mask_cmp_ps_mask( __mmask8 k1, __m256 a, __m256 b, int imm);
VCMPSS __mmask8 __mm_cmp_ps_mask( __m128 a, __m128 b, int imm);
VCMPSS __mmask8 __mm_mask_cmp_ps_mask( __mmask8 k1, __m128 a, __m128 b, int imm);
VCMPSS __m256 __mm256_cmp_ps( __m256 a, __m256 b, int imm)
CMPPS __m128 __mm_cmp_ps( __m128 a, __m128 b, int imm)

```

**SIMD Floating-Point Exceptions**

Invalid if SNaN operand and invalid if QNaN and predicate as listed in Table 3-1.

Denormal

**Other Exceptions**

VEX-encoded instructions, see Exceptions Type 2.

EVEX-encoded instructions, see Exceptions Type E2.

## CMPS/CMPSB/CMPSW/CMPSD/CMPSQ—Compare String Operands

Opcode	Instruction	Op/En	64-Bit Mode	Compat/Leg Mode	Description
A6	CMPS <i>m8, m8</i>	Z0	Valid	Valid	For legacy mode, compare byte at address DS:(E)SI with byte at address ES:(E)DI; For 64-bit mode compare byte at address (R)ESI to byte at address (R)EDI. The status flags are set accordingly.
A7	CMPS <i>m16, m16</i>	Z0	Valid	Valid	For legacy mode, compare word at address DS:(E)SI with word at address ES:(E)DI; For 64-bit mode compare word at address (R)ESI with word at address (R)EDI. The status flags are set accordingly.
A7	CMPS <i>m32, m32</i>	Z0	Valid	Valid	For legacy mode, compare dword at address DS:(E)SI at dword at address ES:(E)DI; For 64-bit mode compare dword at address (R)ESI at dword at address (R)EDI. The status flags are set accordingly.
REX.W + A7	CMPS <i>m64, m64</i>	Z0	Valid	N.E.	Compares quadword at address (R)ESI with quadword at address (R)EDI and sets the status flags accordingly.
A6	CMPSB	Z0	Valid	Valid	For legacy mode, compare byte at address DS:(E)SI with byte at address ES:(E)DI; For 64-bit mode compare byte at address (R)ESI with byte at address (R)EDI. The status flags are set accordingly.
A7	CMPSW	Z0	Valid	Valid	For legacy mode, compare word at address DS:(E)SI with word at address ES:(E)DI; For 64-bit mode compare word at address (R)ESI with word at address (R)EDI. The status flags are set accordingly.
A7	CMPSD	Z0	Valid	Valid	For legacy mode, compare dword at address DS:(E)SI with dword at address ES:(E)DI; For 64-bit mode compare dword at address (R)ESI with dword at address (R)EDI. The status flags are set accordingly.
REX.W + A7	CMPSQ	Z0	Valid	N.E.	Compares quadword at address (R)ESI with quadword at address (R)EDI and sets the status flags accordingly.

### Instruction Operand Encoding

Op/En	Operand 1	Operand 2	Operand 3	Operand 4
Z0	NA	NA	NA	NA

### Description

Compares the byte, word, doubleword, or quadword specified with the first source operand with the byte, word, doubleword, or quadword specified with the second source operand and sets the status flags in the EFLAGS register according to the results.

Both source operands are located in memory. The address of the first source operand is read from DS:SI, DS:ESI or RSI (depending on the address-size attribute of the instruction is 16, 32, or 64, respectively). The address of the second source operand is read from ES:DI, ES:EDI or RDI (again depending on the address-size attribute of the instruction is 16, 32, or 64). The DS segment may be overridden with a segment override prefix, but the ES segment cannot be overridden.

At the assembly-code level, two forms of this instruction are allowed: the “explicit-operands” form and the “no-operands” form. The explicit-operands form (specified with the CMPS mnemonic) allows the two source operands to be specified explicitly. Here, the source operands should be symbols that indicate the size and location of the source values. This explicit-operand form is provided to allow documentation. However, note that the documentation provided by this form can be misleading. That is, the source operand symbols must specify the correct type (size) of the operands (bytes, words, or doublewords, quadwords), but they do not have to specify the correct loca-



tion. Locations of the source operands are always specified by the DS:(E)SI (or RSI) and ES:(E)DI (or RDI) registers, which must be loaded correctly before the compare string instruction is executed.

The no-operands form provides “short forms” of the byte, word, and doubleword versions of the CMPS instructions. Here also the DS:(E)SI (or RSI) and ES:(E)DI (or RDI) registers are assumed by the processor to specify the location of the source operands. The size of the source operands is selected with the mnemonic: CMPSB (byte comparison), CMPSW (word comparison), CMPSD (doubleword comparison), or CMPSQ (quadword comparison using REX.W).

After the comparison, the (E/R)SI and (E/R)DI registers increment or decrement automatically according to the setting of the DF flag in the EFLAGS register. (If the DF flag is 0, the (E/R)SI and (E/R)DI register increment; if the DF flag is 1, the registers decrement.) The registers increment or decrement by 1 for byte operations, by 2 for word operations, 4 for doubleword operations. If operand size is 64, RSI and RDI registers increment by 8 for quadword operations.

The CMPS, CMPSB, CMPSW, CMPSD, and CMPSQ instructions can be preceded by the REP prefix for block comparisons. More often, however, these instructions will be used in a LOOP construct that takes some action based on the setting of the status flags before the next comparison is made. See “REP/REPE/REPZ /REPNE/REPZ—Repeat String Operation Prefix” in Chapter 4 of the *Intel® 64 and IA-32 Architectures Software Developer’s Manual, Volume 2B*, for a description of the REP prefix.

In 64-bit mode, the instruction’s default address size is 64 bits, 32 bit address size is supported using the prefix 67H. Use of the REX.W prefix promotes doubleword operation to 64 bits (see CMPSQ). See the summary chart at the beginning of this section for encoding data and limits.

## Operation

```
temp ← SRC1 - SRC2;
setStatusFlags(temp);
```

IF (64-Bit Mode)

THEN

IF (Byte comparison)

THEN IF DF = 0

THEN

(R)ESI ← (R)ESI + 1;

(R)EDI ← (R)EDI + 1;

ELSE

(R)ESI ← (R)ESI - 1;

(R)EDI ← (R)EDI - 1;

FI;

ELSE IF (Word comparison)

THEN IF DF = 0

THEN

(R)ESI ← (R)ESI + 2;

(R)EDI ← (R)EDI + 2;

ELSE

(R)ESI ← (R)ESI - 2;

(R)EDI ← (R)EDI - 2;

FI;

ELSE IF (Doubleword comparison)

THEN IF DF = 0

THEN

(R)ESI ← (R)ESI + 4;

(R)EDI ← (R)EDI + 4;

ELSE

(R)ESI ← (R)ESI - 4;

(R)EDI ← (R)EDI - 4;

FI;

```

ELSE (* Quadword comparison *)
    THEN IF DF = 0
        (R)ESI ← (R)ESI + 8;
        (R)EDI ← (R)EDI + 8;
    ELSE
        (R)ESI ← (R)ESI - 8;
        (R)EDI ← (R)EDI - 8;
    FI;
FI;
ELSE (* Non-64-bit Mode *)
    IF (byte comparison)
        THEN IF DF = 0
            THEN
                (E)SI ← (E)SI + 1;
                (E)DI ← (E)DI + 1;
            ELSE
                (E)SI ← (E)SI - 1;
                (E)DI ← (E)DI - 1;
            FI;
        ELSE IF (Word comparison)
            THEN IF DF = 0
                (E)SI ← (E)SI + 2;
                (E)DI ← (E)DI + 2;
            ELSE
                (E)SI ← (E)SI - 2;
                (E)DI ← (E)DI - 2;
            FI;
        ELSE (* Doubleword comparison *)
            THEN IF DF = 0
                (E)SI ← (E)SI + 4;
                (E)DI ← (E)DI + 4;
            ELSE
                (E)SI ← (E)SI - 4;
                (E)DI ← (E)DI - 4;
            FI;
        FI;
FI;

```

### Flags Affected

The CF, OF, SF, ZF, AF, and PF flags are set according to the temporary result of the comparison.

### Protected Mode Exceptions

#GP(0)	If a memory operand effective address is outside the CS, DS, ES, FS, or GS segment limit. If the DS, ES, FS, or GS register contains a NULL segment selector.
#SS(0)	If a memory operand effective address is outside the SS segment limit.
#PF(fault-code)	If a page fault occurs.
#AC(0)	If alignment checking is enabled and an unaligned memory reference is made while the current privilege level is 3.
#UD	If the LOCK prefix is used.

**Real-Address Mode Exceptions**

#GP	If a memory operand effective address is outside the CS, DS, ES, FS, or GS segment limit.
#SS	If a memory operand effective address is outside the SS segment limit.
#UD	If the LOCK prefix is used.

**Virtual-8086 Mode Exceptions**

#GP(0)	If a memory operand effective address is outside the CS, DS, ES, FS, or GS segment limit.
#SS(0)	If a memory operand effective address is outside the SS segment limit.
#PF(fault-code)	If a page fault occurs.
#AC(0)	If alignment checking is enabled and an unaligned memory reference is made.
#UD	If the LOCK prefix is used.

**Compatibility Mode Exceptions**

Same exceptions as in protected mode.

**64-Bit Mode Exceptions**

#SS(0)	If a memory address referencing the SS segment is in a non-canonical form.
#GP(0)	If the memory address is in a non-canonical form.
#PF(fault-code)	If a page fault occurs.
#AC(0)	If alignment checking is enabled and an unaligned memory reference is made while the current privilege level is 3.
#UD	If the LOCK prefix is used.

## CMPSD—Compare Scalar Double-Precision Floating-Point Value

Opcode/ Instruction	Op / En	64/32 bit Mode Support	CPUID Feature Flag	Description
F2 0F C2 /r ib CMPSD xmm1, xmm2/m64, imm8	A	V/V	SSE2	Compare low double-precision floating-point value in xmm2/m64 and xmm1 using bits 2:0 of imm8 as comparison predicate.
VEEX.NDS.LIG.F2.0F.WIG C2 /r ib VCMPD xmm1, xmm2, xmm3/m64, imm8	B	V/V	AVX	Compare low double-precision floating-point value in xmm3/m64 and xmm2 using bits 4:0 of imm8 as comparison predicate.
EVEX.NDS.LIG.F2.0F.W1 C2 /r ib VCMPD k1 {k2}, xmm2, xmm3/m64{sae}, imm8	C	V/V	AVX512F	Compare low double-precision floating-point value in xmm3/m64 and xmm2 using bits 4:0 of imm8 as comparison predicate with writemask k2 and leave the result in mask register k1.

### Instruction Operand Encoding

Op/En	Tuple Type	Operand 1	Operand 2	Operand 3	Operand 4
A	NA	ModRM:reg (r, w)	ModRM:r/m (r)	Imm8	NA
B	NA	ModRM:reg (w)	VEEX.vvvv	ModRM:r/m (r)	Imm8
C	Tuple1 Scalar	ModRM:reg (w)	EVEX.vvvv	ModRM:r/m (r)	Imm8

### Description

Compares the low double-precision floating-point values in the second source operand and the first source operand and returns the results in of the comparison to the destination operand. The comparison predicate operand (immediate operand) specifies the type of comparison performed.

128-bit Legacy SSE version: The first source and destination operand (first operand) is an XMM register. The second source operand (second operand) can be an XMM register or 64-bit memory location. Bits (MAXVL-1:64) of the corresponding YMM destination register remain unchanged. The comparison result is a quadword mask of all 1s (comparison true) or all 0s (comparison false).

VEX.128 encoded version: The first source operand (second operand) is an XMM register. The second source operand (third operand) can be an XMM register or a 64-bit memory location. The result is stored in the low quadword of the destination operand; the high quadword is filled with the contents of the high quadword of the first source operand. Bits (MAXVL-1:128) of the destination ZMM register are zeroed. The comparison result is a quadword mask of all 1s (comparison true) or all 0s (comparison false).

EVEX encoded version: The first source operand (second operand) is an XMM register. The second source operand can be a XMM register or a 64-bit memory location. The destination operand (first operand) is an opmask register. The comparison result is a single mask bit of 1 (comparison true) or 0 (comparison false), written to the destination starting from the LSB according to the writemask k2. Bits (MAX\_KL-1:128) of the destination register are cleared.

The comparison predicate operand is an 8-bit immediate:

- For instructions encoded using the VEX prefix, bits 4:0 define the type of comparison to be performed (see Table 3-1). Bits 5 through 7 of the immediate are reserved.
- For instruction encodings that do not use VEX prefix, bits 2:0 define the type of comparison to be made (see the first 8 rows of Table 3-1). Bits 3 through 7 of the immediate are reserved.

The unordered relationship is true when at least one of the two source operands being compared is a NaN; the ordered relationship is true when neither source operand is a NaN.

A subsequent computational instruction that uses the mask result in the destination operand as an input operand will not generate an exception, because a mask of all 0s corresponds to a floating-point value of +0.0 and a mask of all 1s corresponds to a QNaN.

Note that processors with "CPUID.1H:ECX.AVX =0" do not implement the "greater-than", "greater-than-or-equal", "not-greater than", and "not-greater-than-or-equal relations" predicates. These comparisons can be made either by using the inverse relationship (that is, use the "not-less-than-or-equal" to make a "greater-than" comparison)

or by using software emulation. When using software emulation, the program must swap the operands (copying registers when necessary to protect the data that will now be in the destination), and then perform the compare using a different predicate. The predicate to be used for these emulations is listed in the first 8 rows of Table 3-7 (*Intel 64 and IA-32 Architectures Software Developer's Manual Volume 2A*) under the heading Emulation.

Compilers and assemblers may implement the following two-operand pseudo-ops in addition to the three-operand CMPSD instruction, for processors with "CPUID.1H:ECX.AVX =0". See Table 3-6. Compiler should treat reserved Imm8 values as illegal syntax.

**Table 3-6. Pseudo-Op and CMPSD Implementation**

Pseudo-Op	CMPSD Implementation
CMPEQSD <i>xmm1, xmm2</i>	CMPSD <i>xmm1, xmm2, 0</i>
CMPLTSD <i>xmm1, xmm2</i>	CMPSD <i>xmm1, xmm2, 1</i>
CMPLSD <i>xmm1, xmm2</i>	CMPSD <i>xmm1, xmm2, 2</i>
CMPUNORDSD <i>xmm1, xmm2</i>	CMPSD <i>xmm1, xmm2, 3</i>
CMPNEQSD <i>xmm1, xmm2</i>	CMPSD <i>xmm1, xmm2, 4</i>
CMPNLTSD <i>xmm1, xmm2</i>	CMPSD <i>xmm1, xmm2, 5</i>
CMPNLESD <i>xmm1, xmm2</i>	CMPSD <i>xmm1, xmm2, 6</i>
CMPORDSD <i>xmm1, xmm2</i>	CMPSD <i>xmm1, xmm2, 7</i>

The greater-than relations that the processor does not implement require more than one instruction to emulate in software and therefore should not be implemented as pseudo-ops. (For these, the programmer should reverse the operands of the corresponding less than relations and use move instructions to ensure that the mask is moved to the correct destination register and that the source operand is left intact.)

Processors with "CPUID.1H:ECX.AVX =1" implement the full complement of 32 predicates shown in Table 3-7, software emulation is no longer needed. Compilers and assemblers may implement the following three-operand pseudo-ops in addition to the four-operand VCMPSD instruction. See Table 3-7, where the notations of *reg1*, *reg2*, and *reg3* represent either XMM registers or YMM registers. Compiler should treat reserved Imm8 values as illegal syntax. Alternately, intrinsics can map the pseudo-ops to pre-defined constants to support a simpler intrinsic interface. Compilers and assemblers may implement three-operand pseudo-ops for EVEX encoded VCMPSD instructions in a similar fashion by extending the syntax listed in Table 3-7.

**Table 3-7. Pseudo-Op and VCMPSD Implementation**

Pseudo-Op	VCMPSD Implementation
VCMPEQSD <i>reg1, reg2, reg3</i>	VCMPSD <i>reg1, reg2, reg3, 0</i>
VCMPLTSD <i>reg1, reg2, reg3</i>	VCMPSD <i>reg1, reg2, reg3, 1</i>
VCMPLSD <i>reg1, reg2, reg3</i>	VCMPSD <i>reg1, reg2, reg3, 2</i>
VCMPUNORDSD <i>reg1, reg2, reg3</i>	VCMPSD <i>reg1, reg2, reg3, 3</i>
VCMPNEQSD <i>reg1, reg2, reg3</i>	VCMPSD <i>reg1, reg2, reg3, 4</i>
VCMNLTSD <i>reg1, reg2, reg3</i>	VCMPSD <i>reg1, reg2, reg3, 5</i>
VCMNLESD <i>reg1, reg2, reg3</i>	VCMPSD <i>reg1, reg2, reg3, 6</i>
VCMPORDSD <i>reg1, reg2, reg3</i>	VCMPSD <i>reg1, reg2, reg3, 7</i>
VCMPEQ_UQSD <i>reg1, reg2, reg3</i>	VCMPSD <i>reg1, reg2, reg3, 8</i>
VCMPNGESD <i>reg1, reg2, reg3</i>	VCMPSD <i>reg1, reg2, reg3, 9</i>
VCMPNGTSD <i>reg1, reg2, reg3</i>	VCMPSD <i>reg1, reg2, reg3, 0AH</i>
VCMPFALSESD <i>reg1, reg2, reg3</i>	VCMPSD <i>reg1, reg2, reg3, 0BH</i>
VCMPNEQ_OQSD <i>reg1, reg2, reg3</i>	VCMPSD <i>reg1, reg2, reg3, 0CH</i>
VCMPGESD <i>reg1, reg2, reg3</i>	VCMPSD <i>reg1, reg2, reg3, 0DH</i>



22: OP5 ←NLE\_UQ;  
 23: OP5 ←ORD\_S;  
 24: OP5 ←EQ\_US;  
 25: OP5 ←NGE\_UQ;  
 26: OP5 ←NGT\_UQ;  
 27: OP5 ←FALSE\_OS;  
 28: OP5 ←NEQ\_OS;  
 29: OP5 ←GE\_OQ;  
 30: OP5 ←GT\_OQ;  
 31: OP5 ←TRUE\_US;  
 DEFAULT: Reserved

ESAC;

#### VCMPD (EVEX encoded version)

CMPO ← SRC1[63:0] OP5 SRC2[63:0];

IF k2[0] or \*no writemask\*

THEN IF CMPO = TRUE

THEN DEST[0] ← 1;

ELSE DEST[0] ← 0; FI;

ELSE DEST[0] ← 0 ; zeroing-masking only

FI;

DEST[MAX\_KL-1:1] ← 0

#### CMPSD (128-bit Legacy SSE version)

CMPO ←DEST[63:0] OP3 SRC[63:0];

IF CMPO = TRUE

THEN DEST[63:0] ←FFFFFFFFFFFFFFFFH;

ELSE DEST[63:0] ←0000000000000000H; FI;

DEST[MAXVL-1:64] (Unmodified)

#### VCMPD (VEX.128 encoded version)

CMPO ←SRC1[63:0] OP5 SRC2[63:0];

IF CMPO = TRUE

THEN DEST[63:0] ←FFFFFFFFFFFFFFFFH;

ELSE DEST[63:0] ←0000000000000000H; FI;

DEST[127:64] ←SRC1[127:64]

DEST[MAXVL-1:128] ←0

#### Intel C/C++ Compiler Intrinsic Equivalent

VCMPD \_\_mmask8 \_mm\_cmp\_sd\_mask( \_\_m128d a, \_\_m128d b, int imm);

VCMPD \_\_mmask8 \_mm\_cmp\_round\_sd\_mask( \_\_m128d a, \_\_m128d b, int imm, int sae);

VCMPD \_\_mmask8 \_mm\_mask\_cmp\_sd\_mask( \_\_mmask8 k1, \_\_m128d a, \_\_m128d b, int imm);

VCMPD \_\_mmask8 \_mm\_mask\_cmp\_round\_sd\_mask( \_\_mmask8 k1, \_\_m128d a, \_\_m128d b, int imm, int sae);

(V)CMPD \_\_m128d \_mm\_cmp\_sd( \_\_m128d a, \_\_m128d b, const int imm)

#### SIMD Floating-Point Exceptions

Invalid if SNaN operand, Invalid if QNaN and predicate as listed in Table 3-1 Denormal.

#### Other Exceptions

VEX-encoded instructions, see Exceptions Type 3.

EVEX-encoded instructions, see Exceptions Type E3.

## CMPSS—Compare Scalar Single-Precision Floating-Point Value

Opcode/ Instruction	Op / En	64/32 bit Mode Support	CPUID Feature Flag	Description
F3 0F C2 /r ib CMPSS xmm1, xmm2/m32, imm8	A	V/V	SSE	Compare low single-precision floating-point value in xmm2/m32 and xmm1 using bits 2:0 of imm8 as comparison predicate.
VEX.NDS.LIG.F3.0F.WIG C2 /r ib VCMPSS xmm1, xmm2, xmm3/m32, imm8	B	V/V	AVX	Compare low single-precision floating-point value in xmm3/m32 and xmm2 using bits 4:0 of imm8 as comparison predicate.
EVEX.NDS.LIG.F3.0F.WO C2 /r ib VCMPSS k1 {k2}, xmm2, xmm3/m32{sae}, imm8	C	V/V	AVX512F	Compare low single-precision floating-point value in xmm3/m32 and xmm2 using bits 4:0 of imm8 as comparison predicate with writemask k2 and leave the result in mask register k1.

### Instruction Operand Encoding

Op/En	Tuple Type	Operand 1	Operand 2	Operand 3	Operand 4
A	NA	ModRM:reg (r, w)	ModRM:r/m (r)	Imm8	NA
B	NA	ModRM:reg (w)	VEX.vvvv	ModRM:r/m (r)	Imm8
C	Tuple1 Scalar	ModRM:reg (w)	EVEX.vvvv	ModRM:r/m (r)	Imm8

### Description

Compares the low single-precision floating-point values in the second source operand and the first source operand and returns the results of the comparison to the destination operand. The comparison predicate operand (immediate operand) specifies the type of comparison performed.

128-bit Legacy SSE version: The first source and destination operand (first operand) is an XMM register. The second source operand (second operand) can be an XMM register or 32-bit memory location. Bits (MAXVL-1:32) of the corresponding YMM destination register remain unchanged. The comparison result is a doubleword mask of all 1s (comparison true) or all 0s (comparison false).

VEX.128 encoded version: The first source operand (second operand) is an XMM register. The second source operand (third operand) can be an XMM register or a 32-bit memory location. The result is stored in the low 32 bits of the destination operand; bits 128:32 of the destination operand are copied from the first source operand. Bits (MAXVL-1:128) of the destination ZMM register are zeroed. The comparison result is a doubleword mask of all 1s (comparison true) or all 0s (comparison false).

EVEX encoded version: The first source operand (second operand) is an XMM register. The second source operand can be a XMM register or a 32-bit memory location. The destination operand (first operand) is an opmask register. The comparison result is a single mask bit of 1 (comparison true) or 0 (comparison false), written to the destination starting from the LSB according to the writemask k2. Bits (MAX\_KL-1:128) of the destination register are cleared.

The comparison predicate operand is an 8-bit immediate:

- For instructions encoded using the VEX prefix, bits 4:0 define the type of comparison to be performed (see Table 3-1). Bits 5 through 7 of the immediate are reserved.
- For instruction encodings that do not use VEX prefix, bits 2:0 define the type of comparison to be made (see the first 8 rows of Table 3-1). Bits 3 through 7 of the immediate are reserved.

The unordered relationship is true when at least one of the two source operands being compared is a NaN; the ordered relationship is true when neither source operand is a NaN.

A subsequent computational instruction that uses the mask result in the destination operand as an input operand will not generate an exception, because a mask of all 0s corresponds to a floating-point value of +0.0 and a mask of all 1s corresponds to a QNaN.

Note that processors with "CPUID.1H:ECX.AVX =0" do not implement the "greater-than", "greater-than-or-equal", "not-greater than", and "not-greater-than-or-equal relations" predicates. These comparisons can be made either



by using the inverse relationship (that is, use the “not-less-than-or-equal” to make a “greater-than” comparison) or by using software emulation. When using software emulation, the program must swap the operands (copying registers when necessary to protect the data that will now be in the destination), and then perform the compare using a different predicate. The predicate to be used for these emulations is listed in the first 8 rows of Table 3-7 (*Intel 64 and IA-32 Architectures Software Developer’s Manual Volume 2A*) under the heading Emulation.

Compilers and assemblers may implement the following two-operand pseudo-ops in addition to the three-operand CMPSS instruction, for processors with “CPUID.1H:ECX.AVX = 0”. See Table 3-8. Compiler should treat reserved Imm8 values as illegal syntax.

**Table 3-8. Pseudo-Op and CMPSS Implementation**

Pseudo-Op	CMPSS Implementation
CMPEQSS <i>xmm1, xmm2</i>	CMPSS <i>xmm1, xmm2, 0</i>
CMPLTSS <i>xmm1, xmm2</i>	CMPSS <i>xmm1, xmm2, 1</i>
CMPLSS <i>xmm1, xmm2</i>	CMPSS <i>xmm1, xmm2, 2</i>
CMPUNORDSS <i>xmm1, xmm2</i>	CMPSS <i>xmm1, xmm2, 3</i>
CMPNEQSS <i>xmm1, xmm2</i>	CMPSS <i>xmm1, xmm2, 4</i>
CMPNLTSS <i>xmm1, xmm2</i>	CMPSS <i>xmm1, xmm2, 5</i>
CMPNLESS <i>xmm1, xmm2</i>	CMPSS <i>xmm1, xmm2, 6</i>
CMPORDSS <i>xmm1, xmm2</i>	CMPSS <i>xmm1, xmm2, 7</i>

The greater-than relations that the processor does not implement require more than one instruction to emulate in software and therefore should not be implemented as pseudo-ops. (For these, the programmer should reverse the operands of the corresponding less than relations and use move instructions to ensure that the mask is moved to the correct destination register and that the source operand is left intact.)

Processors with “CPUID.1H:ECX.AVX = 1” implement the full complement of 32 predicates shown in Table 3-7, software emulation is no longer needed. Compilers and assemblers may implement the following three-operand pseudo-ops in addition to the four-operand VCMPS instruction. See Table 3-9, where the notations of reg1 reg2, and reg3 represent either XMM registers or YMM registers. Compiler should treat reserved Imm8 values as illegal syntax. Alternately, intrinsics can map the pseudo-ops to pre-defined constants to support a simpler intrinsic interface. Compilers and assemblers may implement three-operand pseudo-ops for EVEX encoded VCMPS instructions in a similar fashion by extending the syntax listed in Table 3-9.

**Table 3-9. Pseudo-Op and VCMPS Implementation**

Pseudo-Op	VCMPS Implementation
VCMPEQSS <i>reg1, reg2, reg3</i>	VCMPS <i>reg1, reg2, reg3, 0</i>
VCMPLTSS <i>reg1, reg2, reg3</i>	VCMPS <i>reg1, reg2, reg3, 1</i>
VCMPLSS <i>reg1, reg2, reg3</i>	VCMPS <i>reg1, reg2, reg3, 2</i>
VCMPUNORDSS <i>reg1, reg2, reg3</i>	VCMPS <i>reg1, reg2, reg3, 3</i>
VCMPNEQSS <i>reg1, reg2, reg3</i>	VCMPS <i>reg1, reg2, reg3, 4</i>
VCMNLTSS <i>reg1, reg2, reg3</i>	VCMPS <i>reg1, reg2, reg3, 5</i>
VCMNLESS <i>reg1, reg2, reg3</i>	VCMPS <i>reg1, reg2, reg3, 6</i>
VCMPODSS <i>reg1, reg2, reg3</i>	VCMPS <i>reg1, reg2, reg3, 7</i>
VCMPEQ_UQSS <i>reg1, reg2, reg3</i>	VCMPS <i>reg1, reg2, reg3, 8</i>
VCMNGESS <i>reg1, reg2, reg3</i>	VCMPS <i>reg1, reg2, reg3, 9</i>
VCMNGTSS <i>reg1, reg2, reg3</i>	VCMPS <i>reg1, reg2, reg3, 0AH</i>
VCMFALSESS <i>reg1, reg2, reg3</i>	VCMPS <i>reg1, reg2, reg3, 0BH</i>
VCMPEQ_OQSS <i>reg1, reg2, reg3</i>	VCMPS <i>reg1, reg2, reg3, 0CH</i>
VCMGESS <i>reg1, reg2, reg3</i>	VCMPS <i>reg1, reg2, reg3, 0DH</i>



22: OP5 ←NLE\_UQ;  
 23: OP5 ←ORD\_S;  
 24: OP5 ←EQ\_US;  
 25: OP5 ←NGE\_UQ;  
 26: OP5 ←NGT\_UQ;  
 27: OP5 ←FALSE\_OS;  
 28: OP5 ←NEQ\_OS;  
 29: OP5 ←GE\_OQ;  
 30: OP5 ←GT\_OQ;  
 31: OP5 ←TRUE\_US;  
 DEFAULT: Reserved

ESAC;

#### VCMPPSS (EVEX encoded version)

CMPO ← SRC1[31:0] OP5 SRC2[31:0];

IF k2[0] or \*no writemask\*

THEN IF CMPO = TRUE

THEN DEST[0] ← 1;

ELSE DEST[0] ← 0; FI;

ELSE DEST[0] ← 0 ; zeroing-masking only

FI;

DEST[MAX\_KL-1:1] ← 0

#### CMPPSS (128-bit Legacy SSE version)

CMPO ←DEST[31:0] OP3 SRC[31:0];

IF CMPO = TRUE

THEN DEST[31:0] ←FFFFFFFFH;

ELSE DEST[31:0] ←00000000H; FI;

DEST[MAXVL-1:32] (Unmodified)

#### VCMPPSS (VEX.128 encoded version)

CMPO ←SRC1[31:0] OP5 SRC2[31:0];

IF CMPO = TRUE

THEN DEST[31:0] ←FFFFFFFFH;

ELSE DEST[31:0] ←00000000H; FI;

DEST[127:32] ←SRC1[127:32]

DEST[MAXVL-1:128] ←0

#### Intel C/C++ Compiler Intrinsic Equivalent

VCMPPSS \_\_mmask8 \_\_mm\_cmp\_ss\_mask( \_\_m128 a, \_\_m128 b, int imm);

VCMPPSS \_\_mmask8 \_\_mm\_cmp\_round\_ss\_mask( \_\_m128 a, \_\_m128 b, int imm, int sae);

VCMPPSS \_\_mmask8 \_\_mm\_mask\_cmp\_ss\_mask( \_\_mmask8 k1, \_\_m128 a, \_\_m128 b, int imm);

VCMPPSS \_\_mmask8 \_\_mm\_mask\_cmp\_round\_ss\_mask( \_\_mmask8 k1, \_\_m128 a, \_\_m128 b, int imm, int sae);

(V)CMPPSS \_\_m128 \_\_mm\_cmp\_ss(\_\_m128 a, \_\_m128 b, const int imm)

#### SIMD Floating-Point Exceptions

Invalid if SNaN operand, Invalid if QNaN and predicate as listed in Table 3-1, Denormal.

#### Other Exceptions

VEX-encoded instructions, see Exceptions Type 3.

EVEX-encoded instructions, see Exceptions Type E3.

## CMPXCHG—Compare and Exchange

Opcode/ Instruction	Op/ En	64-Bit Mode	Compat/ Leg Mode	Description
OF B0/ <i>r</i> CMPXCHG <i>r/m8, r8</i>	MR	Valid	Valid*	Compare AL with <i>r/m8</i> . If equal, ZF is set and <i>r8</i> is loaded into <i>r/m8</i> . Else, clear ZF and load <i>r/m8</i> into AL.
REX + OF B0/ <i>r</i> CMPXCHG <i>r/m8**, r8</i>	MR	Valid	N.E.	Compare AL with <i>r/m8</i> . If equal, ZF is set and <i>r8</i> is loaded into <i>r/m8</i> . Else, clear ZF and load <i>r/m8</i> into AL.
OF B1/ <i>r</i> CMPXCHG <i>r/m16, r16</i>	MR	Valid	Valid*	Compare AX with <i>r/m16</i> . If equal, ZF is set and <i>r16</i> is loaded into <i>r/m16</i> . Else, clear ZF and load <i>r/m16</i> into AX.
OF B1/ <i>r</i> CMPXCHG <i>r/m32, r32</i>	MR	Valid	Valid*	Compare EAX with <i>r/m32</i> . If equal, ZF is set and <i>r32</i> is loaded into <i>r/m32</i> . Else, clear ZF and load <i>r/m32</i> into EAX.
REX.W + OF B1/ <i>r</i> CMPXCHG <i>r/m64, r64</i>	MR	Valid	N.E.	Compare RAX with <i>r/m64</i> . If equal, ZF is set and <i>r64</i> is loaded into <i>r/m64</i> . Else, clear ZF and load <i>r/m64</i> into RAX.

### NOTES:

\* See the IA-32 Architecture Compatibility section below.

\*\* In 64-bit mode, *r/m8* can not be encoded to access the following byte registers if a REX prefix is used: AH, BH, CH, DH.

### Instruction Operand Encoding

Op/En	Operand 1	Operand 2	Operand 3	Operand 4
MR	ModRM:r/m ( <i>r, w</i> )	ModRM:reg ( <i>r</i> )	NA	NA

### Description

Compares the value in the AL, AX, EAX, or RAX register with the first operand (destination operand). If the two values are equal, the second operand (source operand) is loaded into the destination operand. Otherwise, the destination operand is loaded into the AL, AX, EAX or RAX register. RAX register is available only in 64-bit mode.

This instruction can be used with a LOCK prefix to allow the instruction to be executed atomically. To simplify the interface to the processor's bus, the destination operand receives a write cycle without regard to the result of the comparison. The destination operand is written back if the comparison fails; otherwise, the source operand is written into the destination. (The processor never produces a locked read without also producing a locked write.)

In 64-bit mode, the instruction's default operation size is 32 bits. Use of the REX.R prefix permits access to additional registers (R8-R15). Use of the REX.W prefix promotes operation to 64 bits. See the summary chart at the beginning of this section for encoding data and limits.

### IA-32 Architecture Compatibility

This instruction is not supported on Intel processors earlier than the Intel486 processors.

### Operation

(\* Accumulator = AL, AX, EAX, or RAX depending on whether a byte, word, doubleword, or quadword comparison is being performed \*)

TEMP ← DEST

IF accumulator = TEMP

THEN

ZF ← 1;

DEST ← SRC;

ELSE

ZF ← 0;

accumulator ← TEMP;

DEST ← TEMP;

FI;

## Flags Affected

The ZF flag is set if the values in the destination operand and register AL, AX, or EAX are equal; otherwise it is cleared. The CF, PF, AF, SF, and OF flags are set according to the results of the comparison operation.

## Protected Mode Exceptions

#GP(0)	If the destination is located in a non-writable segment. If a memory operand effective address is outside the CS, DS, ES, FS, or GS segment limit. If the DS, ES, FS, or GS register contains a NULL segment selector.
#SS(0)	If a memory operand effective address is outside the SS segment limit.
#PF(fault-code)	If a page fault occurs.
#AC(0)	If alignment checking is enabled and an unaligned memory reference is made while the current privilege level is 3.
#UD	If the LOCK prefix is used but the destination is not a memory operand.

## Real-Address Mode Exceptions

#GP	If a memory operand effective address is outside the CS, DS, ES, FS, or GS segment limit.
#SS	If a memory operand effective address is outside the SS segment limit.
#UD	If the LOCK prefix is used but the destination is not a memory operand.

## Virtual-8086 Mode Exceptions

#GP(0)	If a memory operand effective address is outside the CS, DS, ES, FS, or GS segment limit.
#SS(0)	If a memory operand effective address is outside the SS segment limit.
#PF(fault-code)	If a page fault occurs.
#AC(0)	If alignment checking is enabled and an unaligned memory reference is made.
#UD	If the LOCK prefix is used but the destination is not a memory operand.

## Compatibility Mode Exceptions

Same exceptions as in protected mode.

## 64-Bit Mode Exceptions

#SS(0)	If a memory address referencing the SS segment is in a non-canonical form.
#GP(0)	If the memory address is in a non-canonical form.
#PF(fault-code)	If a page fault occurs.
#AC(0)	If alignment checking is enabled and an unaligned memory reference is made while the current privilege level is 3.
#UD	If the LOCK prefix is used but the destination is not a memory operand.

**CMPXCHG8B/CMPXCHG16B—Compare and Exchange Bytes**

Opcode/ Instruction	Op/ En	64-Bit Mode	Compat/ Leg Mode	Description
OF C7 /1 <i>m64</i> CMPXCHG8B <i>m64</i>	M	Valid	Valid*	Compare EDX:EAX with <i>m64</i> . If equal, set ZF and load ECX:EBX into <i>m64</i> . Else, clear ZF and load <i>m64</i> into EDX:EAX.
REX.W + OF C7 /1 <i>m128</i> CMPXCHG16B <i>m128</i>	M	Valid	N.E.	Compare RDX:RAX with <i>m128</i> . If equal, set ZF and load RCX:RBX into <i>m128</i> . Else, clear ZF and load <i>m128</i> into RDX:RAX.

**NOTES:**

\*See IA-32 Architecture Compatibility section below.

**Instruction Operand Encoding**

Op/En	Operand 1	Operand 2	Operand 3	Operand 4
M	ModRM:r/m (r, w)	NA	NA	NA

**Description**

Compares the 64-bit value in EDX:EAX (or 128-bit value in RDX:RAX if operand size is 128 bits) with the operand (destination operand). If the values are equal, the 64-bit value in ECX:EBX (or 128-bit value in RCX:RBX) is stored in the destination operand. Otherwise, the value in the destination operand is loaded into EDX:EAX (or RDX:RAX). The destination operand is an 8-byte memory location (or 16-byte memory location if operand size is 128 bits). For the EDX:EAX and ECX:EBX register pairs, EDX and ECX contain the high-order 32 bits and EAX and EBX contain the low-order 32 bits of a 64-bit value. For the RDX:RAX and RCX:RBX register pairs, RDX and RCX contain the high-order 64 bits and RAX and RBX contain the low-order 64bits of a 128-bit value.

This instruction can be used with a LOCK prefix to allow the instruction to be executed atomically. To simplify the interface to the processor's bus, the destination operand receives a write cycle without regard to the result of the comparison. The destination operand is written back if the comparison fails; otherwise, the source operand is written into the destination. (The processor never produces a locked read without also producing a locked write.)

In 64-bit mode, default operation size is 64 bits. Use of the REX.W prefix promotes operation to 128 bits. Note that CMPXCHG16B requires that the destination (memory) operand be 16-byte aligned. See the summary chart at the beginning of this section for encoding data and limits. For information on the CPUID flag that indicates CMPXCHG16B, see page 3-209.

**IA-32 Architecture Compatibility**

This instruction encoding is not supported on Intel processors earlier than the Pentium processors.

## Operation

```

IF (64-Bit Mode and OperandSize = 64)
  THEN
    TEMP128 ← DEST
    IF (RDX:RAX = TEMP128)
      THEN
        ZF ← 1;
        DEST ← RCX:RBX;
      ELSE
        ZF ← 0;
        RDX:RAX ← TEMP128;
        DEST ← TEMP128;
        FI;
      FI
    ELSE
      TEMP64 ← DEST;
      IF (EDX:EAX = TEMP64)
        THEN
          ZF ← 1;
          DEST ← ECX:EBX;
        ELSE
          ZF ← 0;
          EDX:EAX ← TEMP64;
          DEST ← TEMP64;
          FI;
        FI;
      FI;
    FI;
  FI;

```

## Flags Affected

The ZF flag is set if the destination operand and EDX:EAX are equal; otherwise it is cleared. The CF, PF, AF, SF, and OF flags are unaffected.

## Protected Mode Exceptions

#UD	If the destination is not a memory operand.
#GP(0)	If the destination is located in a non-writable segment. If a memory operand effective address is outside the CS, DS, ES, FS, or GS segment limit. If the DS, ES, FS, or GS register contains a NULL segment selector.
#SS(0)	If a memory operand effective address is outside the SS segment limit.
#PF(fault-code)	If a page fault occurs.
#AC(0)	If alignment checking is enabled and an unaligned memory reference is made while the current privilege level is 3.

## Real-Address Mode Exceptions

#UD	If the destination operand is not a memory location.
#GP	If a memory operand effective address is outside the CS, DS, ES, FS, or GS segment limit.
#SS	If a memory operand effective address is outside the SS segment limit.

### Virtual-8086 Mode Exceptions

#UD	If the destination operand is not a memory location.
#GP(0)	If a memory operand effective address is outside the CS, DS, ES, FS, or GS segment limit.
#SS(0)	If a memory operand effective address is outside the SS segment limit.
#PF(fault-code)	If a page fault occurs.
#AC(0)	If alignment checking is enabled and an unaligned memory reference is made.

### Compatibility Mode Exceptions

Same exceptions as in protected mode.

### 64-Bit Mode Exceptions

#SS(0)	If a memory address referencing the SS segment is in a non-canonical form.
#GP(0)	If the memory address is in a non-canonical form. If memory operand for CMPXCHG16B is not aligned on a 16-byte boundary. If CPUID.01H:ECX.CMPXCHG16B[bit 13] = 0.
#UD	If the destination operand is not a memory location.
#PF(fault-code)	If a page fault occurs.
#AC(0)	If alignment checking is enabled and an unaligned memory reference is made while the current privilege level is 3.



## COMISD—Compare Scalar Ordered Double-Precision Floating-Point Values and Set EFLAGS

Opcode/ Instruction	Op/ En	64/32 bit Mode Support	CPUID Feature Flag	Description
66 0F 2F /r COMISD xmm1, xmm2/m64	A	V/V	SSE2	Compare low double-precision floating-point values in xmm1 and xmm2/mem64 and set the EFLAGS flags accordingly.
VEX.LIG.66.0F.WIG 2F /r VCOMISD xmm1, xmm2/m64	A	V/V	AVX	Compare low double-precision floating-point values in xmm1 and xmm2/mem64 and set the EFLAGS flags accordingly.
EVEX.LIG.66.0F.W1 2F /r VCOMISD xmm1, xmm2/m64{sae}	B	V/V	AVX512F	Compare low double-precision floating-point values in xmm1 and xmm2/mem64 and set the EFLAGS flags accordingly.

### Instruction Operand Encoding

Op/En	Tuple Type	Operand 1	Operand 2	Operand 3	Operand 4
A	NA	ModRM:reg (w)	ModRM:r/m (r)	NA	NA
B	Tuple1 Scalar	ModRM:reg (w)	ModRM:r/m (r)	NA	NA

### Description

Compares the double-precision floating-point values in the low quadwords of operand 1 (first operand) and operand 2 (second operand), and sets the ZF, PF, and CF flags in the EFLAGS register according to the result (unordered, greater than, less than, or equal). The OF, SF and AF flags in the EFLAGS register are set to 0. The unordered result is returned if either source operand is a NaN (QNaN or SNaN).

Operand 1 is an XMM register; operand 2 can be an XMM register or a 64 bit memory

location. The COMISD instruction differs from the UCOMISD instruction in that it signals a SIMD floating-point invalid operation exception (#I) when a source operand is either a QNaN or SNaN. The UCOMISD instruction signals an invalid numeric exception only if a source operand is an SNaN.

The EFLAGS register is not updated if an unmasked SIMD floating-point exception is generated.

VEX.vvvv and EVEX.vvvv are reserved and must be 1111b, otherwise instructions will #UD.

Software should ensure VCOMISD is encoded with VEX.L=0. Encoding VCOMISD with VEX.L=1 may encounter unpredictable behavior across different processor generations.

### Operation

#### COMISD (all versions)

```
RESULT ← OrderedCompare(DEST[63:0] <> SRC[63:0]) {
```

```
(* Set EFLAGS *) CASE (RESULT) OF
```

```
  UNORDERED: ZF,PF,CF ← 111;
```

```
  GREATER_THAN: ZF,PF,CF ← 000;
```

```
  LESS_THAN: ZF,PF,CF ← 001;
```

```
  EQUAL: ZF,PF,CF ← 100;
```

```
ESAC;
```

```
OF, AF, SF ← 0; }
```

### Intel C/C++ Compiler Intrinsic Equivalent

VCOMISD int \_\_mm\_comi\_round\_sd(\_\_m128d a, \_\_m128d b, int imm, int sae);  
VCOMISD int \_\_mm\_comieq\_sd (\_\_m128d a, \_\_m128d b)  
VCOMISD int \_\_mm\_comilt\_sd (\_\_m128d a, \_\_m128d b)  
VCOMISD int \_\_mm\_comile\_sd (\_\_m128d a, \_\_m128d b)  
VCOMISD int \_\_mm\_comigt\_sd (\_\_m128d a, \_\_m128d b)  
VCOMISD int \_\_mm\_comige\_sd (\_\_m128d a, \_\_m128d b)  
VCOMISD int \_\_mm\_comineq\_sd (\_\_m128d a, \_\_m128d b)

### SIMD Floating-Point Exceptions

Invalid (if SNaN or QNaN operands), Denormal.

### Other Exceptions

VEX-encoded instructions, see Exceptions Type 3;

EVEX-encoded instructions, see Exceptions Type E3NF.

#UD                      If VEX.vvvv != 1111B or EVEX.vvvv != 1111B.

## COMISS—Compare Scalar Ordered Single-Precision Floating-Point Values and Set EFLAGS

Opcode/ Instruction	Op/ En	64/32 bit Mode Support	CPUID Feature Flag	Description
NP OF 2F /r COMISS xmm1, xmm2/m32	A	V/V	SSE	Compare low single-precision floating-point values in xmm1 and xmm2/mem32 and set the EFLAGS flags accordingly.
VEX.LIG.OF.WIG 2F /r VCOMISS xmm1, xmm2/m32	A	V/V	AVX	Compare low single-precision floating-point values in xmm1 and xmm2/mem32 and set the EFLAGS flags accordingly.
EVEX.LIG.OF.WO 2F /r VCOMISS xmm1, xmm2/m32{sae}	B	V/V	AVX512F	Compare low single-precision floating-point values in xmm1 and xmm2/mem32 and set the EFLAGS flags accordingly.

### Instruction Operand Encoding

Op/En	Tuple Type	Operand 1	Operand 2	Operand 3	Operand 4
A	NA	ModRM:reg (w)	ModRM:r/m (r)	NA	NA
B	Tuple1 Scalar	ModRM:reg (w)	ModRM:r/m (r)	NA	NA

### Description

Compares the single-precision floating-point values in the low quadwords of operand 1 (first operand) and operand 2 (second operand), and sets the ZF, PF, and CF flags in the EFLAGS register according to the result (unordered, greater than, less than, or equal). The OF, SF and AF flags in the EFLAGS register are set to 0. The unordered result is returned if either source operand is a NaN (QNaN or SNaN).

Operand 1 is an XMM register; operand 2 can be an XMM register or a 32 bit memory location.

The COMISS instruction differs from the UCOMISS instruction in that it signals a SIMD floating-point invalid operation exception (#I) when a source operand is either a QNaN or SNaN. The UCOMISS instruction signals an invalid numeric exception only if a source operand is an SNaN.

The EFLAGS register is not updated if an unmasked SIMD floating-point exception is generated.

VEX.vvvv and EVEX.vvvv are reserved and must be 1111b, otherwise instructions will #UD.

Software should ensure VCOMISS is encoded with VEX.L=0. Encoding VCOMISS with VEX.L=1 may encounter unpredictable behavior across different processor generations.

### Operation

#### COMISS (all versions)

```
RESULT ← OrderedCompare(DEST[31:0] <> SRC[31:0]) {
```

```
(* Set EFLAGS *) CASE (RESULT) OF
```

```
  UNORDERED: ZF,PF,CF ← 111;
```

```
  GREATER_THAN: ZF,PF,CF ← 000;
```

```
  LESS_THAN: ZF,PF,CF ← 001;
```

```
  EQUAL: ZF,PF,CF ← 100;
```

```
ESAC;
```

```
OF, AF, SF ← 0; }
```

### Intel C/C++ Compiler Intrinsic Equivalent

VCOMISS int \_\_mm\_comi\_round\_ss(\_\_m128 a, \_\_m128 b, int imm, int sae);  
VCOMISS int \_\_mm\_comieq\_ss (\_\_m128 a, \_\_m128 b)  
VCOMISS int \_\_mm\_comilt\_ss (\_\_m128 a, \_\_m128 b)  
VCOMISS int \_\_mm\_comile\_ss (\_\_m128 a, \_\_m128 b)  
VCOMISS int \_\_mm\_comigt\_ss (\_\_m128 a, \_\_m128 b)  
VCOMISS int \_\_mm\_comige\_ss (\_\_m128 a, \_\_m128 b)  
VCOMISS int \_\_mm\_comineq\_ss (\_\_m128 a, \_\_m128 b)

### SIMD Floating-Point Exceptions

Invalid (if SNaN or QNaN operands), Denormal.

### Other Exceptions

VEX-encoded instructions, see Exceptions Type 3;

EVEX-encoded instructions, see Exceptions Type E3NF.

#UD                      If VEX.vvvv != 1111B or EVEX.vvvv != 1111B.

## CPUID—CPU Identification

Opcode	Instruction	Op/En	64-Bit Mode	Compat/Leg Mode	Description
0F A2	CPUID	Z0	Valid	Valid	Returns processor identification and feature information to the EAX, EBX, ECX, and EDX registers, as determined by input entered in EAX (in some cases, ECX as well).

### Instruction Operand Encoding

Op/En	Operand 1	Operand 2	Operand 3	Operand 4
Z0	NA	NA	NA	NA

### Description

The ID flag (bit 21) in the EFLAGS register indicates support for the CPUID instruction. If a software procedure can set and clear this flag, the processor executing the procedure supports the CPUID instruction. This instruction operates the same in non-64-bit modes and 64-bit mode.

CPUID returns processor identification and feature information in the EAX, EBX, ECX, and EDX registers.<sup>1</sup> The instruction's output is dependent on the contents of the EAX register upon execution (in some cases, ECX as well). For example, the following pseudocode loads EAX with 00H and causes CPUID to return a Maximum Return Value and the Vendor Identification String in the appropriate registers:

```
MOV EAX, 00H
CPUID
```

Table 3-8 shows information returned, depending on the initial value loaded into the EAX register.

Two types of information are returned: basic and extended function information. If a value entered for CPUID.EAX is higher than the maximum input value for basic or extended function for that processor then the data for the highest basic information leaf is returned. For example, using the Intel Core i7 processor, the following is true:

```
CPUID.EAX = 05H (* Returns MONITOR/MWAIT leaf. *)
CPUID.EAX = 0AH (* Returns Architectural Performance Monitoring leaf. *)
CPUID.EAX = 0BH (* Returns Extended Topology Enumeration leaf. *)
CPUID.EAX = 0CH (* INVALID: Returns the same information as CPUID.EAX = 0BH. *)
CPUID.EAX = 80000008H (* Returns linear/physical address size data. *)
CPUID.EAX = 8000000AH (* INVALID: Returns same information as CPUID.EAX = 0BH. *)
```

If a value entered for CPUID.EAX is less than or equal to the maximum input value and the leaf is not supported on that processor then 0 is returned in all the registers.

When CPUID returns the highest basic leaf information as a result of an invalid input EAX value, any dependence on input ECX value in the basic leaf is honored.

CPUID can be executed at any privilege level to serialize instruction execution. Serializing instruction execution guarantees that any modifications to flags, registers, and memory for previous instructions are completed before the next instruction is fetched and executed.

#### See also:

"Serializing Instructions" in Chapter 8, "Multiple-Processor Management," in the *Intel® 64 and IA-32 Architectures Software Developer's Manual, Volume 3A*.

"Caching Translation Information" in Chapter 4, "Paging," in the *Intel® 64 and IA-32 Architectures Software Developer's Manual, Volume 3A*.

1. On Intel 64 processors, CPUID clears the high 32 bits of the RAX/RBX/RCX/RDX registers in all modes.

**Table 3-8. Information Returned by CPUID Instruction**

Initial EAX Value	Information Provided about the Processor	
<i>Basic CPUID Information</i>		
0H	EAX	Maximum Input Value for Basic CPUID Information.
	EBX	"Genu"
	ECX	"ntel"
	EDX	"inel"
01H	EAX	Version Information: Type, Family, Model, and Stepping ID (see Figure 3-6).
	EBX	Bits 07 - 00: Brand Index. Bits 15 - 08: CLFLUSH line size (Value * 8 = cache line size in bytes; used also by CLFLUSHOPT). Bits 23 - 16: Maximum number of addressable IDs for logical processors in this physical package*. Bits 31 - 24: Initial APIC ID.
	ECX	Feature Information (see Figure 3-7 and Table 3-10).
	EDX	Feature Information (see Figure 3-8 and Table 3-11).
		<b>NOTES:</b> * The nearest power-of-2 integer that is not smaller than EBX[23:16] is the number of unique initial APIC IDs reserved for addressing different logical processors in a physical package. This field is only valid if CPUID.1.EDX.HTT[bit 28]= 1.
02H	EAX	Cache and TLB Information (see Table 3-12).
	EBX	Cache and TLB Information.
	ECX	Cache and TLB Information.
	EDX	Cache and TLB Information.
03H	EAX	Reserved.
	EBX	Reserved.
	ECX	Bits 00 - 31 of 96 bit processor serial number. (Available in Pentium III processor only; otherwise, the value in this register is reserved.)
	EDX	Bits 32 - 63 of 96 bit processor serial number. (Available in Pentium III processor only; otherwise, the value in this register is reserved.)
		<b>NOTES:</b> Processor serial number (PSN) is not supported in the Pentium 4 processor or later. On all models, use the PSN flag (returned using CPUID) to check for PSN support before accessing the feature.
CPUID leaves above 2 and below 80000000H are visible only when IA32_MISC_ENABLE[bit 22] has its default value of 0.		
<i>Deterministic Cache Parameters Leaf</i>		
04H		<b>NOTES:</b> Leaf 04H output depends on the initial value in ECX.* See also: "INPUT EAX = 04H: Returns Deterministic Cache Parameters for Each Level" on page 217.
	EAX	Bits 04 - 00: Cache Type Field. 0 = Null - No more caches. 1 = Data Cache. 2 = Instruction Cache. 3 = Unified Cache. 4-31 = Reserved.

Table 3-8. Information Returned by CPUID Instruction (Contd.)

Initial EAX Value	Information Provided about the Processor	
		<p>Bits 07 - 05: Cache Level (starts at 1).            Bit 08: Self Initializing cache level (does not need SW initialization).            Bit 09: Fully Associative cache.</p> <p>Bits 13 - 10: Reserved.            Bits 25 - 14: Maximum number of addressable IDs for logical processors sharing this cache**, ***,            Bits 31 - 26: Maximum number of addressable IDs for processor cores in the physical package**, ***, ****, *****.</p> <p>EBX Bits 11 - 00: L = System Coherency Line Size**.            Bits 21 - 12: P = Physical Line partitions**.            Bits 31 - 22: W = Ways of associativity**.</p> <p>ECX Bits 31-00: S = Number of Sets**.</p> <p>EDX Bit 00: Write-Back Invalidate/Invalidate.            0 = WBINVD/INVD from threads sharing this cache acts upon lower level caches for threads sharing this cache.            1 = WBINVD/INVD is not guaranteed to act upon lower level caches of non-originating threads sharing this cache.</p> <p>Bit 01: Cache Inclusiveness.            0 = Cache is not inclusive of lower cache levels.            1 = Cache is inclusive of lower cache levels.</p> <p>Bit 02: Complex Cache Indexing.            0 = Direct mapped cache.            1 = A complex function is used to index the cache, potentially using all address bits.</p> <p>Bits 31 - 03: Reserved = 0.</p> <p><b>NOTES:</b></p> <p>* If ECX contains an invalid sub leaf index, EAX/EBX/ECX/EDX return 0. Sub-leaf index n+1 is invalid if sub-leaf n returns EAX[4:0] as 0.</p> <p>** Add one to the return value to get the result.</p> <p>***The nearest power-of-2 integer that is not smaller than (1 + EAX[25:14]) is the number of unique initial APIC IDs reserved for addressing different logical processors sharing this cache.</p> <p>**** The nearest power-of-2 integer that is not smaller than (1 + EAX[31:26]) is the number of unique Core_IDs reserved for addressing different processor cores in a physical package. Core ID is a subset of bits of the initial APIC ID.</p> <p>***** The returned value is constant for valid initial values in ECX. Valid ECX values start from 0.</p>
	<i>MONITOR/MWAIT Leaf</i>	
05H	EAX	Bits 15 - 00: Smallest monitor-line size in bytes (default is processor's monitor granularity). Bits 31 - 16: Reserved = 0.
	EBX	Bits 15 - 00: Largest monitor-line size in bytes (default is processor's monitor granularity). Bits 31 - 16: Reserved = 0.
	ECX	Bit 00: Enumeration of Monitor-Mwait extensions (beyond EAX and EBX registers) supported. Bit 01: Supports treating interrupts as break-event for MWAIT, even when interrupts disabled. Bits 31 - 02: Reserved.

**Table 3-8. Information Returned by CPUID Instruction (Contd.)**

Initial EAX Value	Information Provided about the Processor	
	EDX	Bits 03 - 00: Number of C0* sub C-states supported using MWAIT. Bits 07 - 04: Number of C1* sub C-states supported using MWAIT. Bits 11 - 08: Number of C2* sub C-states supported using MWAIT. Bits 15 - 12: Number of C3* sub C-states supported using MWAIT. Bits 19 - 16: Number of C4* sub C-states supported using MWAIT. Bits 23 - 20: Number of C5* sub C-states supported using MWAIT. Bits 27 - 24: Number of C6* sub C-states supported using MWAIT. Bits 31 - 28: Number of C7* sub C-states supported using MWAIT. <b>NOTE:</b> * The definition of C0 through C7 states for MWAIT extension are processor-specific C-states, not ACPI C-states.
<i>Thermal and Power Management Leaf</i>		
06H	EAX	Bit 00: Digital temperature sensor is supported if set. Bit 01: Intel Turbo Boost Technology available (see description of IA32_MISC_ENABLE[38]). Bit 02: ARAT. APIC-Timer-always-running feature is supported if set. Bit 03: Reserved. Bit 04: PLN. Power limit notification controls are supported if set. Bit 05: ECMD. Clock modulation duty cycle extension is supported if set. Bit 06: PTM. Package thermal management is supported if set. Bit 07: HWP. HWP base registers (IA32_PM_ENABLE[bit 0], IA32_HWP_CAPABILITIES, IA32_HWP_REQUEST, IA32_HWP_STATUS) are supported if set. Bit 08: HWP_Notification. IA32_HWP_INTERRUPT MSR is supported if set. Bit 09: HWP_Activity_Window. IA32_HWP_REQUEST[bits 41:32] is supported if set. Bit 10: HWP_Energy_Performance_Preference. IA32_HWP_REQUEST[bits 31:24] is supported if set. Bit 11: HWP_Package_Level_Request. IA32_HWP_REQUEST_PKG MSR is supported if set. Bit 12: Reserved. Bit 13: HDC. HDC base registers IA32_PKG_HDC_CTL, IA32_PM_CTL1, IA32_THREAD_STALL MSRs are supported if set. Bit 14: Intel® Turbo Boost Max Technology 3.0 available. Bits 31 - 15: Reserved.
	EBX	Bits 03 - 00: Number of Interrupt Thresholds in Digital Thermal Sensor. Bits 31 - 04: Reserved.
	ECX	Bit 00: Hardware Coordination Feedback Capability (Presence of IA32_MPERF and IA32_APERF). The capability to provide a measure of delivered processor performance (since last reset of the counters), as a percentage of the expected processor performance when running at the TSC frequency. Bits 02 - 01: Reserved = 0. Bit 03: The processor supports performance-energy bias preference if CPUID.06H:ECX.SETBH[bit 3] is set and it also implies the presence of a new architectural MSR called IA32_ENERGY_PERF_BIAS (1BOH). Bits 31 - 04: Reserved = 0.
	EDX	Reserved = 0.



**Table 3-8. Information Returned by CPUID Instruction (Contd.)**

Initial EAX Value	Information Provided about the Processor
<i>Structured Extended Feature Flags Enumeration Leaf (Output depends on ECX input value)</i>	
07H	<p data-bbox="435 338 716 365" style="text-align: center;">Sub-leaf 0 (Input ECX = 0). *</p> <p data-bbox="285 415 1211 443">EAX      Bits 31 - 00: Reports the maximum input value for supported leaf 7 sub-leaves.</p> <p data-bbox="285 457 1443 1415">EBX      Bit 00: FSGSBASE. Supports RDFSBASE/RDGSBASE/WRFSBASE/WRGSBASE if 1.  Bit 01: IA32_TSC_ADJUST MSR is supported if 1.  Bit 02: SGX. Supports Intel® Software Guard Extensions (Intel® SGX Extensions) if 1.  Bit 03: BMI1.  Bit 04: HLE.  Bit 05: AVX2.  Bit 06: FDP_EXCPTN_ONLY. x87 FPU Data Pointer updated only on x87 exceptions if 1.  Bit 07: SMEP. Supports Supervisor-Mode Execution Prevention if 1.  Bit 08: BMI2.  Bit 09: Supports Enhanced REP MOVSB/STOSB if 1.  Bit 10: INVPCID. If 1, supports INVPCID instruction for system software that manages process-context identifiers.  Bit 11: RTM.  Bit 12: RDT-M. Supports Intel® Resource Director Technology (Intel® RDT) Monitoring capability if 1.  Bit 13: Deprecates FPU CS and FPU DS values if 1.  Bit 14: MPX. Supports Intel® Memory Protection Extensions if 1.  Bit 15: RDT-A. Supports Intel® Resource Director Technology (Intel® RDT) Allocation capability if 1.  Bit 16: AVX512F.  Bit 17: AVX512DQ.  Bit 18: RDSEED.  Bit 19: ADX.  Bit 20: SMAP. Supports Supervisor-Mode Access Prevention (and the CLAC/STAC instructions) if 1.  Bit 21: AVX512_IFMA.  Bit 22: Reserved.  Bit 23: CLFLUSHOPT.  Bit 24: CLWB.  Bit 25: Intel Processor Trace.  Bit 26: AVX512PF. (Intel® Xeon Phi™ only.)  Bit 27: AVX512ER. (Intel® Xeon Phi™ only.)  Bit 28: AVX512CD.  Bit 29: SHA. supports Intel® Secure Hash Algorithm Extensions (Intel® SHA Extensions) if 1.  Bit 30: AVX512BW.  Bit 31: AVX512VL.</p> <p data-bbox="285 1430 1429 1776">ECX      Bit 00: PREFETCHWT1. (Intel® Xeon Phi™ only.)  Bit 01: AVX512_VBMI.  Bit 02: UMIP. Supports user-mode instruction prevention if 1.  Bit 03: PKU. Supports protection keys for user-mode pages if 1.  Bit 04: OSPKE. If 1, OS has set CR4.PKE to enable protection keys (and the RDPKRU/WRPKRU instructions).  Bits 16 - 5: Reserved.  Bits 21 - 17: The value of MAWAU used by the BNDLDX and BNDSTX instructions in 64-bit mode.  Bit 22: RDPID. Supports Read Processor ID if 1.  Bits 29 - 23: Reserved.  Bit 30: SGX_LC. Supports SGX Launch Configuration if 1.  Bit 31: Reserved.</p>

**Table 3-8. Information Returned by CPUID Instruction (Contd.)**

Initial EAX Value	Information Provided about the Processor	
	EDX	Reserved.  <b>NOTE:</b> * If ECX contains an invalid sub-leaf index, EAX/EBX/ECX/EDX return 0. Sub-leaf index n is invalid if n exceeds the value that sub-leaf 0 returns in EAX.
<i>Direct Cache Access Information Leaf</i>		
09H	EAX	Value of bits [31:0] of IA32_PLATFORM_DCA_CAP MSR (address 1F8H).
	EBX	Reserved.
	ECX	Reserved.
	EDX	Reserved.
<i>Architectural Performance Monitoring Leaf</i>		
0AH	EAX	Bits 07 - 00: Version ID of architectural performance monitoring. Bits 15 - 08: Number of general-purpose performance monitoring counter per logical processor. Bits 23 - 16: Bit width of general-purpose, performance monitoring counter. Bits 31 - 24: Length of EBX bit vector to enumerate architectural performance monitoring events.
	EBX	Bit 00: Core cycle event not available if 1. Bit 01: Instruction retired event not available if 1. Bit 02: Reference cycles event not available if 1. Bit 03: Last-level cache reference event not available if 1. Bit 04: Last-level cache misses event not available if 1. Bit 05: Branch instruction retired event not available if 1. Bit 06: Branch mispredict retired event not available if 1. Bits 31 - 07: Reserved = 0.
	ECX	Reserved = 0.
	EDX	Bits 04 - 00: Number of fixed-function performance counters (if Version ID > 1). Bits 12 - 05: Bit width of fixed-function performance counters (if Version ID > 1). Bits 14 - 13: Reserved = 0. Bit 15: AnyThread deprecation. Bits 31 - 16: Reserved = 0.
<i>Extended Topology Enumeration Leaf</i>		
0BH	<b>NOTES:</b> Most of Leaf 0BH output depends on the initial value in ECX. The EDX output of leaf 0BH is always valid and does not vary with input value in ECX. Output value in ECX[7:0] always equals input value in ECX[7:0]. Sub-leaf index 0 enumerates SMT level. Each subsequent higher sub-leaf index enumerates a higher-level topological entity in hierarchical order. For sub-leaves that return an invalid level-type of 0 in ECX[15:8]; EAX and EBX will return 0. If an input value n in ECX returns the invalid level-type of 0 in ECX[15:8], other input values with ECX > n also return 0 in ECX[15:8].	
	EAX	Bits 04 - 00: Number of bits to shift right on x2APIC ID to get a unique topology ID of the next level type*. All logical processors with the same next level ID share current level. Bits 31 - 05: Reserved.
	EBX	Bits 15 - 00: Number of logical processors at this level type. The number reflects configuration as shipped by Intel**. Bits 31 - 16: Reserved.

**Table 3-8. Information Returned by CPUID Instruction (Contd.)**

Initial EAX Value	Information Provided about the Processor	
	ECX	Bits 07 - 00: Level number. Same value in ECX input. Bits 15 - 08: Level type***. Bits 31 - 16: Reserved.
	EDX	Bits 31 - 00: x2APIC ID the current logical processor.  <b>NOTES:</b> * Software should use this field (EAX[4:0]) to enumerate processor topology of the system. ** Software must not use EBX[15:0] to enumerate processor topology of the system. This value in this field (EBX[15:0]) is only intended for display/diagnostic purposes. The actual number of logical processors available to BIOS/OS/Applications may be different from the value of EBX[15:0], depending on software and platform hardware configurations.  *** The value of the "level type" field is not related to level numbers in any way, higher "level type" values do not mean higher levels. Level type field has the following encoding: 0: Invalid. 1: SMT. 2: Core. 3-255: Reserved.
<i>Processor Extended State Enumeration Main Leaf (EAX = 0DH, ECX = 0)</i>		
0DH		<b>NOTES:</b> Leaf 0DH main leaf (ECX = 0).  EAX Bits 31 - 00: Reports the supported bits of the lower 32 bits of XCR0. XCR0[n] can be set to 1 only if EAX[n] is 1. Bit 00: x87 state. Bit 01: SSE state. Bit 02: AVX state. Bits 04 - 03: MPX state. Bits 07 - 05: AVX-512 state. Bit 08: Used for IA32_XSS. Bit 09: PKRU state. Bits 31 - 10: Reserved.  EBX Bits 31 - 00: Maximum size (bytes, from the beginning of the XSAVE/XRSTOR save area) required by enabled features in XCR0. May be different than ECX if some features at the end of the XSAVE save area are not enabled.  ECX Bit 31 - 00: Maximum size (bytes, from the beginning of the XSAVE/XRSTOR save area) of the XSAVE/XRSTOR save area required by all supported features in the processor, i.e., all the valid bit fields in XCR0.  EDX Bit 31 - 00: Reports the supported bits of the upper 32 bits of XCR0. XCR0[n+32] can be set to 1 only if EDX[n] is 1. Bits 31 - 00: Reserved.
<i>Processor Extended State Enumeration Sub-leaf (EAX = 0DH, ECX = 1)</i>		
0DH	EAX	Bit 00: XSAVEOPT is available. Bit 01: Supports XSAVEC and the compacted form of XRSTOR if set. Bit 02: Supports XGETBV with ECX = 1 if set. Bit 03: Supports XSAVES/XRSTORS and IA32_XSS if set. Bits 31 - 04: Reserved.
	EBX	Bits 31 - 00: The size in bytes of the XSAVE area containing all states enabled by XCR0   IA32_XSS.

**Table 3-8. Information Returned by CPUID Instruction (Contd.)**

Initial EAX Value	Information Provided about the Processor
	<p>ECX Bits 31 - 00: Reports the supported bits of the lower 32 bits of the IA32_XSS MSR. IA32_XSS[n] can be set to 1 only if ECX[n] is 1.            Bits 07 - 00: Used for XCRO.            Bit 08: PT state.            Bit 09: Used for XCRO.            Bits 31 - 10: Reserved.</p> <p>EDX Bits 31 - 00: Reports the supported bits of the upper 32 bits of the IA32_XSS MSR. IA32_XSS[n+32] can be set to 1 only if EDX[n] is 1.            Bits 31 - 00: Reserved.</p>
<i>Processor Extended State Enumeration Sub-leaves (EAX = 0DH, ECX = n, n &gt; 1)</i>	
0DH	<p><b>NOTES:</b>            Leaf 0DH output depends on the initial value in ECX.            Each sub-leaf index (starting at position 2) is supported if it corresponds to a supported bit in either the XCRO register or the IA32_XSS MSR.            * If ECX contains an invalid sub-leaf index, EAX/EBX/ECX/EDX return 0. Sub-leaf n (<math>0 \leq n \leq 31</math>) is invalid if sub-leaf 0 returns 0 in EAX[n] and sub-leaf 1 returns 0 in ECX[n]. Sub-leaf n (<math>32 \leq n \leq 63</math>) is invalid if sub-leaf 0 returns 0 in EDX[n-32] and sub-leaf 1 returns 0 in EDX[n-32].</p> <p>EAX Bits 31 - 0: The size in bytes (from the offset specified in EBX) of the save area for an extended state feature associated with a valid sub-leaf index, n.</p> <p>EBX Bits 31 - 0: The offset in bytes of this extended state component's save area from the beginning of the XSAVE/XRSTOR area.            This field reports 0 if the sub-leaf index, n, does not map to a valid bit in the XCRO register*.</p> <p>ECX Bit 00 is set if the bit n (corresponding to the sub-leaf index) is supported in the IA32_XSS MSR; it is clear if bit n is instead supported in XCRO.            Bit 01 is set if, when the compacted format of an XSAVE area is used, this extended state component located on the next 64-byte boundary following the preceding state component (otherwise, it is located immediately following the preceding state component).            Bits 31 - 02 are reserved.            This field reports 0 if the sub-leaf index, n, is invalid*.</p> <p>EDX This field reports 0 if the sub-leaf index, n, is invalid*; otherwise it is reserved.</p>
<i>Intel Resource Director Technology (Intel RDT) Monitoring Enumeration Sub-leaf (EAX = 0FH, ECX = 0)</i>	
0FH	<p><b>NOTES:</b>            Leaf 0FH output depends on the initial value in ECX.            Sub-leaf index 0 reports valid resource type starting at bit position 1 of EDX.</p> <p>EAX Reserved.</p> <p>EBX Bits 31 - 00: Maximum range (zero-based) of RMID within this physical processor of all types.</p> <p>ECX Reserved.</p> <p>EDX Bit 00: Reserved.            Bit 01: Supports L3 Cache Intel RDT Monitoring if 1.            Bits 31 - 02: Reserved.</p>
<i>L3 Cache Intel RDT Monitoring Capability Enumeration Sub-leaf (EAX = 0FH, ECX = 1)</i>	
0FH	<p><b>NOTES:</b>            Leaf 0FH output depends on the initial value in ECX.</p> <p>EAX Reserved.</p> <p>EBX Bits 31 - 00: Conversion factor from reported IA32_QM_CTR value to occupancy metric (bytes).</p>

**Table 3-8. Information Returned by CPUID Instruction (Contd.)**

Initial EAX Value	Information Provided about the Processor
	ECX Maximum range (zero-based) of RMID of this resource type. EDX Bit 00: Supports L3 occupancy monitoring if 1. Bit 01: Supports L3 Total Bandwidth monitoring if 1. Bit 02: Supports L3 Local Bandwidth monitoring if 1. Bits 31 - 03: Reserved.
<i>Intel Resource Director Technology (Intel RDT) Allocation Enumeration Sub-leaf (EAX = 10H, ECX = 0)</i>	
10H	<b>NOTES:</b> Leaf 10H output depends on the initial value in ECX. Sub-leaf index 0 reports valid resource identification (ResID) starting at bit position 1 of EBX. EAX Reserved. EBX Bit 00: Reserved. Bit 01: Supports L3 Cache Allocation Technology if 1. Bit 02: Supports L2 Cache Allocation Technology if 1. Bit 03: Supports Memory Bandwidth Allocation if 1. Bits 31 - 04: Reserved. ECX Reserved. EDX Reserved.
<i>L3 Cache Allocation Technology Enumeration Sub-leaf (EAX = 10H, ECX = ResID =1)</i>	
10H	<b>NOTES:</b> Leaf 10H output depends on the initial value in ECX. EAX Bits 04 - 00: Length of the capacity bit mask for the corresponding ResID using minus-one notation. Bits 31 - 05: Reserved. EBX Bits 31 - 00: Bit-granular map of isolation/contention of allocation units. ECX Bits 01 - 00: Reserved. Bit 02: Code and Data Prioritization Technology supported if 1. Bits 31 - 03: Reserved. EDX Bits 15 - 00: Highest COS number supported for this ResID. Bits 31 - 16: Reserved.
<i>L2 Cache Allocation Technology Enumeration Sub-leaf (EAX = 10H, ECX = ResID =2)</i>	
10H	<b>NOTES:</b> Leaf 10H output depends on the initial value in ECX. EAX Bits 04 - 00: Length of the capacity bit mask for the corresponding ResID using minus-one notation. Bits 31 - 05: Reserved. EBX Bits 31 - 00: Bit-granular map of isolation/contention of allocation units. ECX Bits 31 - 00: Reserved. EDX Bits 15 - 00: Highest COS number supported for this ResID. Bits 31 - 16: Reserved.
<i>Memory Bandwidth Allocation Enumeration Sub-leaf (EAX = 10H, ECX = ResID =3)</i>	
10H	<b>NOTES:</b> Leaf 10H output depends on the initial value in ECX. EAX Bits 11 - 00: Reports the maximum MBA throttling value supported for the corresponding ResID using minus-one notation. Bits 31 - 12: Reserved.

**Table 3-8. Information Returned by CPUID Instruction (Contd.)**

Initial EAX Value	Information Provided about the Processor
<p>EBX</p> <p>ECX</p> <p>EDX</p>	<p>Bits 31 - 00: Reserved.</p> <p>Bits 01 - 00: Reserved. Bit 02: Reports whether the response of the delay values is linear. Bits 31 - 03: Reserved.</p> <p>Bits 15 - 00: Highest COS number supported for this ResID. Bits 31 - 16: Reserved.</p>
<p><i>Intel SGX Capability Enumeration Leaf, sub-leaf 0 (EAX = 12H, ECX = 0)</i></p>	
<p>12H</p> <p>EAX</p> <p>EBX</p> <p>ECX</p> <p>EDX</p>	<p><b>NOTES:</b> Leaf 12H sub-leaf 0 (ECX = 0) is supported if CPUID.(EAX=07H, ECX=0H):EBX[SGX] = 1.</p> <p>Bit 00: SGX1. If 1, Indicates Intel SGX supports the collection of SGX1 leaf functions. Bit 01: SGX2. If 1, Indicates Intel SGX supports the collection of SGX2 leaf functions. Bits 04 - 02: Reserved. Bit 05: If 1, indicates Intel SGX supports ENCLV instruction leaves EINCVRTCHILD, EDECVIRTCHILD, and ESETCONTEXT. Bit 06: If 1, indicates Intel SGX supports ENCLS instruction leaves ETRACKC, ERDINFO, ELDBC, and ELDUC. Bits 31 - 02: Reserved.</p> <p>Bits 31 - 00: MISCSELECT. Bit vector of supported extended SGX features.</p> <p>Bits 31 - 00: Reserved.</p> <p>Bits 07 - 00: MaxEnclaveSize_Not64. The maximum supported enclave size in non-64-bit mode is 2<sup>(EDX[7:0])</sup>. Bits 15 - 08: MaxEnclaveSize_64. The maximum supported enclave size in 64-bit mode is 2<sup>(EDX[15:8])</sup>. Bits 31 - 16: Reserved.</p>
<p><i>Intel SGX Attributes Enumeration Leaf, sub-leaf 1 (EAX = 12H, ECX = 1)</i></p>	
<p>12H</p> <p>EAX</p> <p>EBX</p> <p>ECX</p> <p>EDX</p>	<p><b>NOTES:</b> Leaf 12H sub-leaf 1 (ECX = 1) is supported if CPUID.(EAX=07H, ECX=0H):EBX[SGX] = 1.</p> <p>Bit 31 - 00: Reports the valid bits of SECS.ATTRIBUTES[31:0] that software can set with ECREATE.</p> <p>Bit 31 - 00: Reports the valid bits of SECS.ATTRIBUTES[63:32] that software can set with ECREATE.</p> <p>Bit 31 - 00: Reports the valid bits of SECS.ATTRIBUTES[95:64] that software can set with ECREATE.</p> <p>Bit 31 - 00: Reports the valid bits of SECS.ATTRIBUTES[127:96] that software can set with ECREATE.</p>
<p><i>Intel SGX EPC Enumeration Leaf, sub-leaves (EAX = 12H, ECX = 2 or higher)</i></p>	
<p>12H</p> <p>EAX</p> <p>Type</p>	<p><b>NOTES:</b> Leaf 12H sub-leaf 2 or higher (ECX &gt;= 2) is supported if CPUID.(EAX=07H, ECX=0H):EBX[SGX] = 1. For sub-leaves (ECX = 2 or higher), definition of EDX,ECX,EBX,EAX[31:4] depends on the sub-leaf type listed below.</p> <p>Bit 03 - 00: Sub-leaf Type 0000b: Indicates this sub-leaf is invalid. 0001b: This sub-leaf enumerates an EPC section. EBX:EAX and EDX:ECX provide information on the Enclave Page Cache (EPC) section. All other type encodings are reserved.</p> <p>0000b. This sub-leaf is invalid. EDX:ECX:EBX:EAX return 0.</p>

Table 3-8. Information Returned by CPUID Instruction (Contd.)

Initial EAX Value	Information Provided about the Processor	
	Type	<p>0001b. This sub-leaf enumerates an EPC sections with EDX:ECX, EBX:EAX defined as follows.</p> <p>EAX[11:04]: Reserved (enumerate 0). EAX[31:12]: Bits 31:12 of the physical address of the base of the EPC section.</p> <p>EBX[19:00]: Bits 51:32 of the physical address of the base of the EPC section. EBX[31:20]: Reserved.</p> <p>ECX[03:00]: EPC section property encoding defined as follows: If EAX[3:0] 0000b, then all bits of the EDX:ECX pair are enumerated as 0. If EAX[3:0] 0001b, then this section has confidentiality and integrity protection. All other encodings are reserved. ECX[11:04]: Reserved (enumerate 0). ECX[31:12]: Bits 31:12 of the size of the corresponding EPC section within the Processor Reserved Memory.</p> <p>EDX[19:00]: Bits 51:32 of the size of the corresponding EPC section within the Processor Reserved Memory. EDX[31:20]: Reserved.</p>
<i>Intel Processor Trace Enumeration Main Leaf (EAX = 14H, ECX = 0)</i>		
14H		<p><b>NOTES:</b> Leaf 14H main leaf (ECX = 0).</p> <p>EAX Bits 31 - 00: Reports the maximum sub-leaf supported in leaf 14H.</p> <p>EBX Bit 00: If 1, indicates that IA32_RTIT_CTL.CR3Filter can be set to 1, and that IA32_RTIT_CR3_MATCH MSR can be accessed. Bit 01: If 1, indicates support of Configurable PSB and Cycle-Accurate Mode. Bit 02: If 1, indicates support of IP Filtering, TraceStop filtering, and preservation of Intel PT MSRs across warm reset. Bit 03: If 1, indicates support of MTC timing packet and suppression of COFI-based packets. Bit 04: If 1, indicates support of PTWRITE. Writes can set IA32_RTIT_CTL[12] (PTWEn) and IA32_RTIT_CTL[5] (FUPonPTw), and PTWRITE can generate packets. Bit 05: If 1, indicates support of Power Event Trace. Writes can set IA32_RTIT_CTL[4] (PwrEvtEn), enabling Power Event Trace packet generation. Bit 31 - 06: Reserved.</p> <p>ECX Bit 00: If 1, Tracing can be enabled with IA32_RTIT_CTL.ToPA = 1, hence utilizing the ToPA output scheme; IA32_RTIT_OUTPUT_BASE and IA32_RTIT_OUTPUT_MASK_PTRS MSRs can be accessed. Bit 01: If 1, ToPA tables can hold any number of output entries, up to the maximum allowed by the MaskOffsetTableOffset field of IA32_RTIT_OUTPUT_MASK_PTRS. Bit 02: If 1, indicates support of Single-Range Output scheme. Bit 03: If 1, indicates support of output to Trace Transport subsystem. Bit 30 - 04: Reserved. Bit 31: If 1, generated packets which contain IP payloads have LIP values, which include the CS base component.</p> <p>EDX Bits 31 - 00: Reserved.</p>
<i>Intel Processor Trace Enumeration Sub-leaf (EAX = 14H, ECX = 1)</i>		
14H		<p>EAX Bits 02 - 00: Number of configurable Address Ranges for filtering. Bits 15 - 03: Reserved. Bits 31 - 16: Bitmap of supported MTC period encodings.</p> <p>EBX Bits 15 - 00: Bitmap of supported Cycle Threshold value encodings. Bit 31 - 16: Bitmap of supported Configurable PSB frequency encodings.</p> <p>ECX Bits 31 - 00: Reserved.</p>

**Table 3-8. Information Returned by CPUID Instruction (Contd.)**

Initial EAX Value	Information Provided about the Processor	
	EDX	Bits 31 - 00: Reserved.
<i>Time Stamp Counter and Nominal Core Crystal Clock Information Leaf</i>		
15H	<p><b>NOTES:</b></p> <p>If EBX[31:0] is 0, the TSC/"core crystal clock" ratio is not enumerated. EBX[31:0]/EAX[31:0] indicates the ratio of the TSC frequency and the core crystal clock frequency. If ECX is 0, the nominal core crystal clock frequency is not enumerated. "TSC frequency" = "core crystal clock frequency" * EBX/EAX. The core crystal clock may differ from the reference clock, bus clock, or core clock frequencies.</p> <p>EAX Bits 31 - 00: An unsigned integer which is the denominator of the TSC/"core crystal clock" ratio.</p> <p>EBX Bits 31 - 00: An unsigned integer which is the numerator of the TSC/"core crystal clock" ratio.</p> <p>ECX Bits 31 - 00: An unsigned integer which is the nominal frequency of the core crystal clock in Hz.</p> <p>EDX Bits 31 - 00: Reserved = 0.</p>	
<i>Processor Frequency Information Leaf</i>		
16H	<p>EAX Bits 15 - 00: Processor Base Frequency (in MHz). Bits 31 - 16: Reserved = 0.</p> <p>EBX Bits 15 - 00: Maximum Frequency (in MHz). Bits 31 - 16: Reserved = 0.</p> <p>ECX Bits 15 - 00: Bus (Reference) Frequency (in MHz). Bits 31 - 16: Reserved = 0.</p> <p>EDX Reserved.</p> <p><b>NOTES:</b></p> <p>* Data is returned from this interface in accordance with the processor's specification and does not reflect actual values. Suitable use of this data includes the display of processor information in like manner to the processor brand string and for determining the appropriate range to use when displaying processor information e.g. frequency history graphs. The returned information should not be used for any other purpose as the returned information does not accurately correlate to information / counters returned by other processor interfaces.</p> <p>While a processor may support the Processor Frequency Information leaf, fields that return a value of zero are not supported.</p>	
<i>System-On-Chip Vendor Attribute Enumeration Main Leaf (EAX = 17H, ECX = 0)</i>		
17H	<p><b>NOTES:</b></p> <p>Leaf 17H main leaf (ECX = 0).                      Leaf 17H output depends on the initial value in ECX.                      Leaf 17H sub-leaves 1 through 3 reports SOC Vendor Brand String.                      Leaf 17H is valid if MaxSOCID_Index &gt;= 3.                      Leaf 17H sub-leaves 4 and above are reserved.</p> <p>EAX Bits 31 - 00: MaxSOCID_Index. Reports the maximum input value of supported sub-leaf in leaf 17H.</p> <p>EBX Bits 15 - 00: SOC Vendor ID.                      Bit 16: IsVendorScheme. If 1, the SOC Vendor ID field is assigned via an industry standard enumeration scheme. Otherwise, the SOC Vendor ID field is assigned by Intel.                      Bits 31 - 17: Reserved = 0.</p> <p>ECX Bits 31 - 00: Project ID. A unique number an SOC vendor assigns to its SOC projects.</p> <p>EDX Bits 31 - 00: Stepping ID. A unique number within an SOC project that an SOC vendor assigns.</p>	



**Table 3-8. Information Returned by CPUID Instruction (Contd.)**

Initial EAX Value	Information Provided about the Processor	
<i>System-On-Chip Vendor Attribute Enumeration Sub-leaf (EAX = 17H, ECX = 1..3)</i>		
17H	EAX EBX ECX EDX	<p>Bit 31 - 00: SOC Vendor Brand String. UTF-8 encoded string.</p> <p>Bit 31 - 00: SOC Vendor Brand String. UTF-8 encoded string.</p> <p>Bit 31 - 00: SOC Vendor Brand String. UTF-8 encoded string.</p> <p>Bit 31 - 00: SOC Vendor Brand String. UTF-8 encoded string.</p> <p><b>NOTES:</b></p> <p>Leaf 17H output depends on the initial value in ECX.</p> <p>SOC Vendor Brand String is a UTF-8 encoded string padded with trailing bytes of 00H.</p> <p>The complete SOC Vendor Brand String is constructed by concatenating in ascending order of EAX:EBX:ECX:EDX and from the sub-leaf 1 fragment towards sub-leaf 3.</p>
<i>System-On-Chip Vendor Attribute Enumeration Sub-leaves (EAX = 17H, ECX &gt; MaxSOCID_Index)</i>		
17H	EAX EBX ECX EDX	<p><b>NOTES:</b></p> <p>Leaf 17H output depends on the initial value in ECX.</p> <p>Bits 31 - 00: Reserved = 0.</p> <p>Bits 31 - 00: Reserved = 0.</p> <p>Bits 31 - 00: Reserved = 0.</p> <p>Bits 31 - 00: Reserved = 0.</p>
<i>Deterministic Address Translation Parameters Main Leaf (EAX = 18H, ECX = 0)</i>		
18H	EAX EBX ECX	<p><b>NOTES:</b></p> <p>Each sub-leaf enumerates a different address translation structure.</p> <p>If ECX contains an invalid sub-leaf index, EAX/EBX/ECX/EDX return 0. Sub-leaf index n is invalid if n exceeds the value that sub-leaf 0 returns in EAX. A sub-leaf index is also invalid if EDX[4:0] returns 0. Valid sub-leaves do not need to be contiguous or in any particular order. A valid sub-leaf may be in a higher input ECX value than an invalid sub-leaf or than a valid sub-leaf of a higher or lower-level structure.</p> <p>* Some unified TLBs will allow a single TLB entry to satisfy data read/write and instruction fetches. Others will require separate entries (e.g., one loaded on data read/write and another loaded on an instruction fetch). Please see the <i>Intel® 64 and IA-32 Architectures Optimization Reference Manual</i> for details of a particular product.</p> <p>** Add one to the return value to get the result.</p> <p>Bits 31 - 00: Reports the maximum input value of supported sub-leaf in leaf 18H.</p> <p>Bit 00: 4K page size entries supported by this structure.            Bit 01: 2MB page size entries supported by this structure.            Bit 02: 4MB page size entries supported by this structure.            Bit 03: 1 GB page size entries supported by this structure.            Bits 07 - 04: Reserved.            Bits 10 - 08: Partitioning (0: Soft partitioning between the logical processors sharing this structure).            Bits 15 - 11: Reserved.            Bits 31 - 16: W = Ways of associativity.</p> <p>Bits 31 - 00: S = Number of Sets.</p>

**Table 3-8. Information Returned by CPUID Instruction (Contd.)**

Initial EAX Value	Information Provided about the Processor
	<p>EDX      Bits 04 - 00: Translation cache type field.                      00000b: Null (indicates this sub-leaf is not valid).                      00001b: Data TLB.                      00010b: Instruction TLB.                      00011b: Unified TLB*.                      All other encodings are reserved.            Bits 07 - 05: Translation cache level (starts at 1).            Bit 08: Fully associative structure.            Bits 13 - 09: Reserved.            Bits 25- 14: Maximum number of addressable IDs for logical processors sharing this translation cache**            Bits 31 - 26: Reserved.</p>
<i>Deterministic Address Translation Parameters Sub-leaf (EAX = 18H, ECX ≥ 1)</i>	
18H	<p><b>NOTES:</b>            Each sub-leaf enumerates a different address translation structure.            If ECX contains an invalid sub-leaf index, EAX/EBX/ECX/EDX return 0. Sub-leaf index n is invalid if n exceeds the value that sub-leaf 0 returns in EAX. A sub-leaf index is also invalid if EDX[4:0] returns 0. Valid sub-leaves do not need to be contiguous or in any particular order. A valid sub-leaf may be in a higher input ECX value than an invalid sub-leaf or than a valid sub-leaf of a higher or lower-level structure.            * Some unified TLBs will allow a single TLB entry to satisfy data read/write and instruction fetches. Others will require separate entries (e.g., one loaded on data read/write and another loaded on an instruction fetch) . Please see the <i>Intel® 64 and IA-32 Architectures Optimization Reference Manual</i> for details of a particular product.            ** Add one to the return value to get the result.</p> <p>EAX      Bits 31 - 00: Reserved.</p> <p>EBX      Bit 00: 4K page size entries supported by this structure.                      Bit 01: 2MB page size entries supported by this structure.                      Bit 02: 4MB page size entries supported by this structure.                      Bit 03: 1 GB page size entries supported by this structure.                      Bits 07 - 04: Reserved.                      Bits 10 - 08: Partitioning (0: Soft partitioning between the logical processors sharing this structure).                      Bits 15 - 11: Reserved.                      Bits 31 - 16: W = Ways of associativity.</p> <p>ECX      Bits 31 - 00: S = Number of Sets.</p> <p>EDX      Bits 04 - 00: Translation cache type field.                      0000b: Null (indicates this sub-leaf is not valid).                      0001b: Data TLB.                      0010b: Instruction TLB.                      0011b: Unified TLB*.                      All other encodings are reserved.            Bits 07 - 05: Translation cache level (starts at 1).            Bit 08: Fully associative structure.            Bits 13 - 09: Reserved.            Bits 25- 14: Maximum number of addressable IDs for logical processors sharing this translation cache**            Bits 31 - 26: Reserved.</p>
<i>Unimplemented CPUID Leaf Functions</i>	
40000000H - 4FFFFFFFH	<p>Invalid. No existing or future CPU will return processor identification or feature information if the initial EAX value is in the range 40000000H to 4FFFFFFFH.</p>

**Table 3-8. Information Returned by CPUID Instruction (Contd.)**

Initial EAX Value	Information Provided about the Processor	
<i>Extended Function CPUID Information</i>		
80000000H	EAX	Maximum Input Value for Extended Function CPUID Information.
	EBX	Reserved.
	ECX	Reserved.
	EDX	Reserved.
80000001H	EAX	Extended Processor Signature and Feature Bits.
	EBX	Reserved.
	ECX	Bit 00: LAHF/SAHF available in 64-bit mode. Bits 04 - 01: Reserved. Bit 05: LZCNT. Bits 07 - 06: Reserved. Bit 08: PREFETCHW. Bits 31 - 09: Reserved.
	EDX	Bits 10 - 00: Reserved. Bit 11: SYSCALL/SYSRET available in 64-bit mode. Bits 19 - 12: Reserved = 0. Bit 20: Execute Disable Bit available. Bits 25 - 21: Reserved = 0. Bit 26: 1-GByte pages are available if 1. Bit 27: RDTSCP and IA32_TSC_AUX are available if 1. Bit 28: Reserved = 0. Bit 29: Intel® 64 Architecture available if 1. Bits 31 - 30: Reserved = 0.
80000002H	EAX	Processor Brand String.
	EBX	Processor Brand String Continued.
	ECX	Processor Brand String Continued.
	EDX	Processor Brand String Continued.
80000003H	EAX	Processor Brand String Continued.
	EBX	Processor Brand String Continued.
	ECX	Processor Brand String Continued.
	EDX	Processor Brand String Continued.
80000004H	EAX	Processor Brand String Continued.
	EBX	Processor Brand String Continued.
	ECX	Processor Brand String Continued.
	EDX	Processor Brand String Continued.
80000005H	EAX	Reserved = 0.
	EBX	Reserved = 0.
	ECX	Reserved = 0.
	EDX	Reserved = 0.
80000006H	EAX	Reserved = 0.
	EBX	Reserved = 0.
	ECX	Bits 07 - 00: Cache Line size in bytes. Bits 11 - 08: Reserved. Bits 15 - 12: L2 Associativity field *. Bits 31 - 16: Cache size in 1K units.
	EDX	Reserved = 0.

**Table 3-8. Information Returned by CPUID Instruction (Contd.)**

Initial EAX Value	Information Provided about the Processor	
		<p><b>NOTES:</b></p> <p>* L2 associativity field encodings:            00H - Disabled.            01H - Direct mapped.            02H - 2-way.            04H - 4-way.            06H - 8-way.            08H - 16-way.            0FH - Fully associative.</p>
80000007H	EAX EBX ECX EDX	Reserved = 0. Reserved = 0. Reserved = 0. Bits 07 - 00: Reserved = 0. Bit 08: Invariant TSC available if 1. Bits 31 - 09: Reserved = 0.
80000008H	EAX  EBX ECX EDX	Linear/Physical Address size. Bits 07 - 00: #Physical Address Bits*. Bits 15 - 08: #Linear Address Bits. Bits 31 - 16: Reserved = 0.  Reserved = 0. Reserved = 0. Reserved = 0.
		<p><b>NOTES:</b></p> <p>* If CPUID.80000008H:EAX[7:0] is supported, the maximum physical address number supported should come from this field.</p>

### INPUT EAX = 0: Returns CPUID's Highest Value for Basic Processor Information and the Vendor Identification String

When CPUID executes with EAX set to 0, the processor returns the highest value the CPUID recognizes for returning basic processor information. The value is returned in the EAX register and is processor specific.

A vendor identification string is also returned in EBX, EDX, and ECX. For Intel processors, the string is "GenuineIntel" and is expressed:

EBX ← 756e6547h (\* "Genu", with G in the low eight bits of BL \*)

EDX ← 49656e69h (\* "inel", with i in the low eight bits of DL \*)

ECX ← 6c65746eh (\* "ntel", with n in the low eight bits of CL \*)

### INPUT EAX = 80000000H: Returns CPUID's Highest Value for Extended Processor Information

When CPUID executes with EAX set to 80000000H, the processor returns the highest value the processor recognizes for returning extended processor information. The value is returned in the EAX register and is processor specific.

### IA32\_BIOS\_SIGN\_ID Returns Microcode Update Signature

For processors that support the microcode update facility, the IA32\_BIOS\_SIGN\_ID MSR is loaded with the update signature whenever CPUID executes. The signature is returned in the upper DWORD. For details, see Chapter 9 in the *Intel® 64 and IA-32 Architectures Software Developer's Manual, Volume 3A*.

**INPUT EAX = 01H: Returns Model, Family, Stepping Information**

When CPUID executes with EAX set to 01H, version information is returned in EAX (see Figure 3-6). For example: model, family, and processor type for the Intel Xeon processor 5100 series is as follows:

- Model — 1111B
- Family — 0101B
- Processor Type — 00B

See Table 3-9 for available processor type values. Stepping IDs are provided as needed.

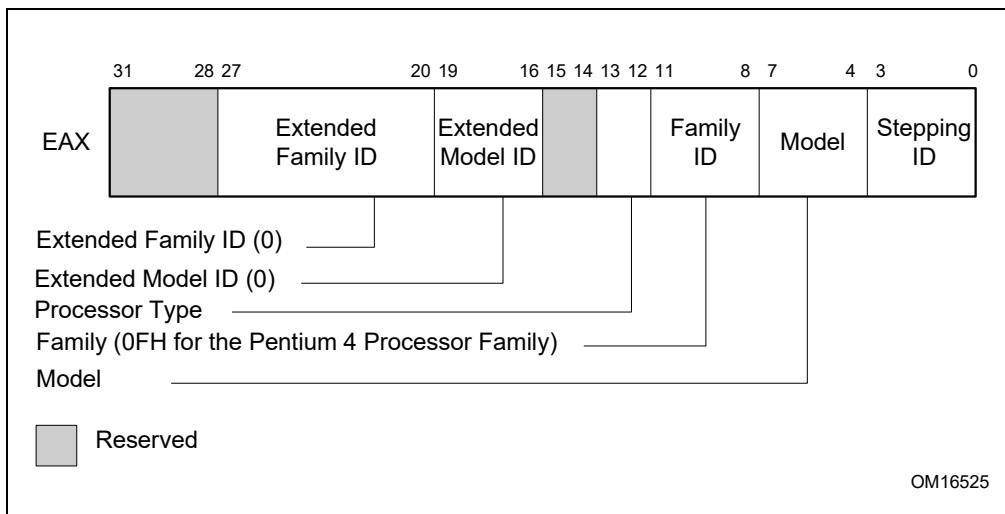

**Figure 3-6. Version Information Returned by CPUID in EAX**

**Table 3-9. Processor Type Field**

Type	Encoding
Original OEM Processor	00B
Intel OverDrive™ Processor	01B
Dual processor (not applicable to Intel486 processors)	10B
Intel reserved	11B

**NOTE**

See Chapter 19 in the *Intel® 64 and IA-32 Architectures Software Developer's Manual, Volume 1*, for information on identifying earlier IA-32 processors.

The Extended Family ID needs to be examined only when the Family ID is 0FH. Integrate the fields into a display using the following rule:

```
IF Family_ID ≠ 0FH
    THEN DisplayFamily = Family_ID;
    ELSE DisplayFamily = Extended_Family_ID + Family_ID;
    (* Right justify and zero-extend 4-bit field. *)
FI;
(* Show DisplayFamily as HEX field. *)
```

The Extended Model ID needs to be examined only when the Family ID is 06H or 0FH. Integrate the field into a display using the following rule:

```
IF (Family_ID = 06H or Family_ID = 0FH)
    THEN DisplayModel = (Extended_Model_ID << 4) + Model_ID;
    (* Right justify and zero-extend 4-bit field; display Model_ID as HEX field.*)
    ELSE DisplayModel = Model_ID;
FI;
(* Show DisplayModel as HEX field. *)
```

### INPUT EAX = 01H: Returns Additional Information in EBX

When CPUID executes with EAX set to 01H, additional information is returned to the EBX register:

- Brand index (low byte of EBX) — this number provides an entry into a brand string table that contains brand strings for IA-32 processors. More information about this field is provided later in this section.
- CLFLUSH instruction cache line size (second byte of EBX) — this number indicates the size of the cache line flushed by the CLFLUSH and CLFLUSHOPT instructions in 8-byte increments. This field was introduced in the Pentium 4 processor.
- Local APIC ID (high byte of EBX) — this number is the 8-bit ID that is assigned to the local APIC on the processor during power up. This field was introduced in the Pentium 4 processor.

### INPUT EAX = 01H: Returns Feature Information in ECX and EDX

When CPUID executes with EAX set to 01H, feature information is returned in ECX and EDX.

- Figure 3-7 and Table 3-10 show encodings for ECX.
- Figure 3-8 and Table 3-11 show encodings for EDX.

For all feature flags, a 1 indicates that the feature is supported. Use Intel to properly interpret feature flags.

### NOTE

Software must confirm that a processor feature is present using feature flags returned by CPUID prior to using the feature. Software should not depend on future offerings retaining all features.

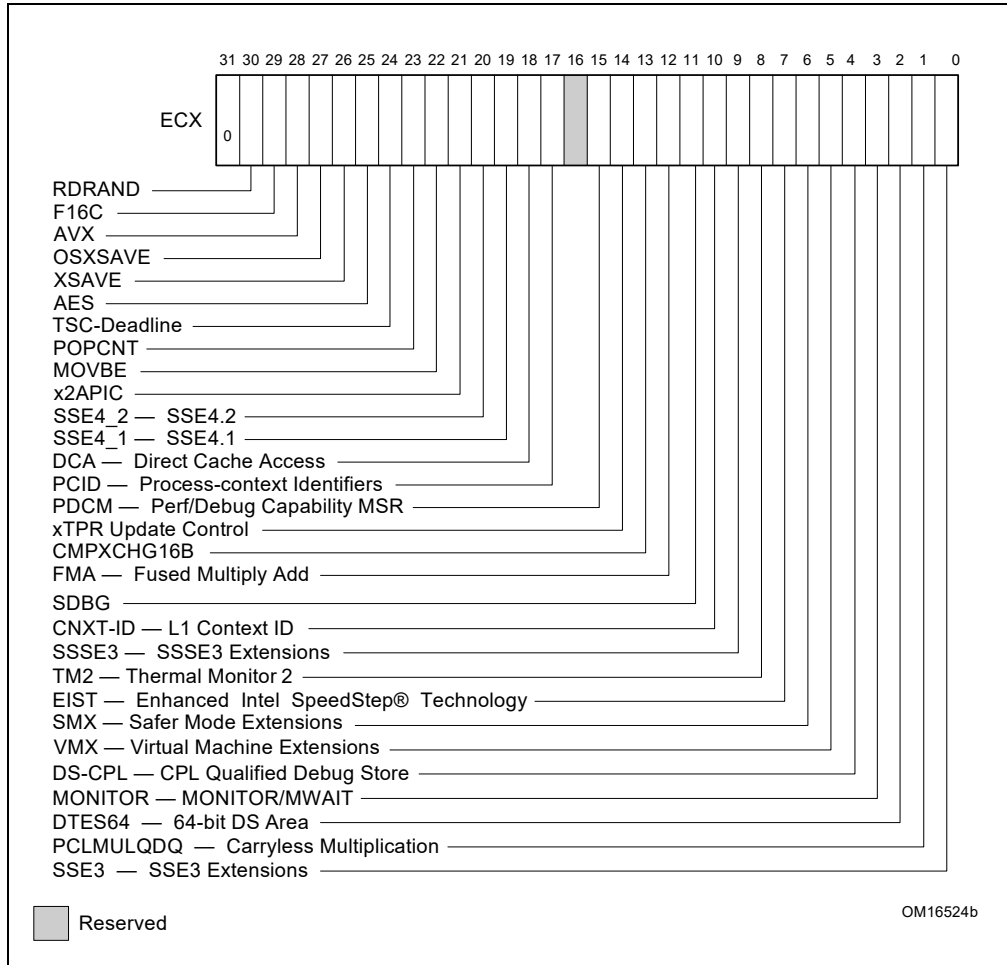

Figure 3-7. Feature Information Returned in the ECX Register

Table 3-10. Feature Information Returned in the ECX Register

Bit #	Mnemonic	Description
0	SSE3	<b>Streaming SIMD Extensions 3 (SSE3).</b> A value of 1 indicates the processor supports this technology.
1	PCLMULQDQ	<b>PCLMULQDQ.</b> A value of 1 indicates the processor supports the PCLMULQDQ instruction.
2	DTES64	<b>64-bit DS Area.</b> A value of 1 indicates the processor supports DS area using 64-bit layout.
3	MONITOR	<b>MONITOR/MWAIT.</b> A value of 1 indicates the processor supports this feature.
4	DS-CPL	<b>CPL Qualified Debug Store.</b> A value of 1 indicates the processor supports the extensions to the Debug Store feature to allow for branch message storage qualified by CPL.
5	VMX	<b>Virtual Machine Extensions.</b> A value of 1 indicates that the processor supports this technology.
6	SMX	<b>Safer Mode Extensions.</b> A value of 1 indicates that the processor supports this technology. See Chapter 6, "Safer Mode Extensions Reference".
7	EIST	<b>Enhanced Intel SpeedStep® technology.</b> A value of 1 indicates that the processor supports this technology.
8	TM2	<b>Thermal Monitor 2.</b> A value of 1 indicates whether the processor supports this technology.
9	SSSE3	A value of 1 indicates the presence of the Supplemental Streaming SIMD Extensions 3 (SSSE3). A value of 0 indicates the instruction extensions are not present in the processor.

Table 3-10. Feature Information Returned in the ECX Register (Contd.)

Bit #	Mnemonic	Description
10	CNXT-ID	<b>L1 Context ID.</b> A value of 1 indicates the L1 data cache mode can be set to either adaptive mode or shared mode. A value of 0 indicates this feature is not supported. See definition of the IA32_MISC_ENABLE MSR Bit 24 (L1 Data Cache Context Mode) for details.
11	SDBG	A value of 1 indicates the processor supports IA32_DEBUG_INTERFACE MSR for silicon debug.
12	FMA	A value of 1 indicates the processor supports FMA extensions using YMM state.
13	CMPXCHG16B	<b>CMPXCHG16B Available.</b> A value of 1 indicates that the feature is available. See the “CMPXCHG8B/CMPXCHG16B—Compare and Exchange Bytes” section in this chapter for a description.
14	xTPR Update Control	<b>xTPR Update Control.</b> A value of 1 indicates that the processor supports changing IA32_MISC_ENABLE[bit 23].
15	PDCM	<b>Perfmon and Debug Capability:</b> A value of 1 indicates the processor supports the performance and debug feature indication MSR IA32_PERF_CAPABILITIES.
16	Reserved	Reserved
17	PCID	<b>Process-context identifiers.</b> A value of 1 indicates that the processor supports PCIDs and that software may set CR4.PCIDE to 1.
18	DCA	A value of 1 indicates the processor supports the ability to prefetch data from a memory mapped device.
19	SSE4.1	A value of 1 indicates that the processor supports SSE4.1.
20	SSE4.2	A value of 1 indicates that the processor supports SSE4.2.
21	x2APIC	A value of 1 indicates that the processor supports x2APIC feature.
22	MOVBE	A value of 1 indicates that the processor supports MOVBE instruction.
23	POPCNT	A value of 1 indicates that the processor supports the POPCNT instruction.
24	TSC-Deadline	A value of 1 indicates that the processor’s local APIC timer supports one-shot operation using a TSC deadline value.
25	AESNI	A value of 1 indicates that the processor supports the AESNI instruction extensions.
26	XSAVE	A value of 1 indicates that the processor supports the XSAVE/XRSTOR processor extended states feature, the XSETBV/XGETBV instructions, and XCRO.
27	OSXSAVE	A value of 1 indicates that the OS has set CR4.OSXSAVE[bit 18] to enable XSETBV/XGETBV instructions to access XCRO and to support processor extended state management using XSAVE/XRSTOR.
28	AVX	A value of 1 indicates the processor supports the AVX instruction extensions.
29	F16C	A value of 1 indicates that processor supports 16-bit floating-point conversion instructions.
30	RDRAND	A value of 1 indicates that processor supports RDRAND instruction.
31	Not Used	Always returns 0.



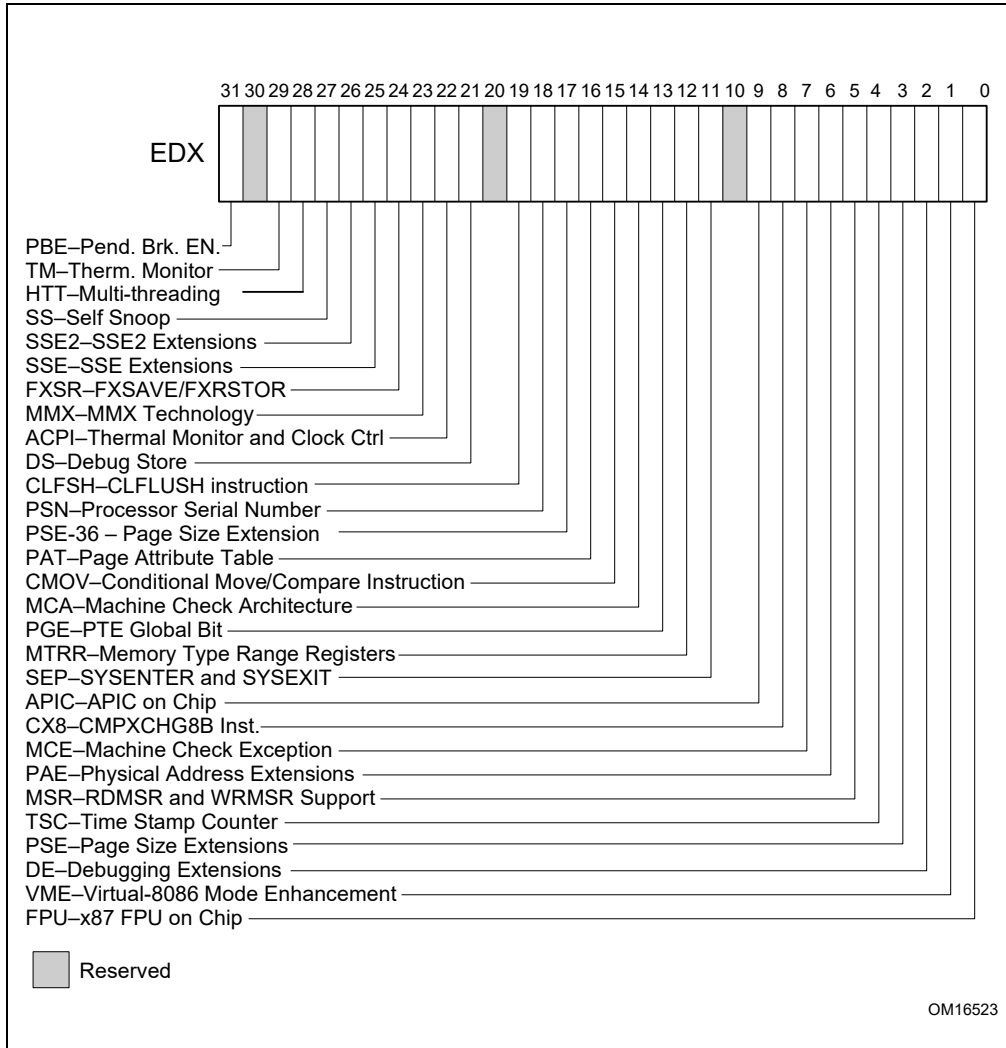

Figure 3-8. Feature Information Returned in the EDX Register

**Table 3-11. More on Feature Information Returned in the EDX Register**

Bit #	Mnemonic	Description
0	FPU	<b>Floating Point Unit On-Chip.</b> The processor contains an x87 FPU.
1	VME	<b>Virtual 8086 Mode Enhancements.</b> Virtual 8086 mode enhancements, including CR4.VME for controlling the feature, CR4.PVI for protected mode virtual interrupts, software interrupt indirection, expansion of the TSS with the software indirection bitmap, and EFLAGS.VIF and EFLAGS.VIP flags.
2	DE	<b>Debugging Extensions.</b> Support for I/O breakpoints, including CR4.DE for controlling the feature, and optional trapping of accesses to DR4 and DR5.
3	PSE	<b>Page Size Extension.</b> Large pages of size 4 MByte are supported, including CR4.PSE for controlling the feature, the defined dirty bit in PDE (Page Directory Entries), optional reserved bit trapping in CR3, PDEs, and PTEs.
4	TSC	<b>Time Stamp Counter.</b> The RDTSC instruction is supported, including CR4.TSD for controlling privilege.
5	MSR	<b>Model Specific Registers RDMSR and WRMSR Instructions.</b> The RDMSR and WRMSR instructions are supported. Some of the MSRs are implementation dependent.
6	PAE	<b>Physical Address Extension.</b> Physical addresses greater than 32 bits are supported: extended page table entry formats, an extra level in the page translation tables is defined, 2-MByte pages are supported instead of 4 Mbyte pages if PAE bit is 1.
7	MCE	<b>Machine Check Exception.</b> Exception 18 is defined for Machine Checks, including CR4.MCE for controlling the feature. This feature does not define the model-specific implementations of machine-check error logging, reporting, and processor shutdowns. Machine Check exception handlers may have to depend on processor version to do model specific processing of the exception, or test for the presence of the Machine Check feature.
8	CX8	<b>CMPXCHG8B Instruction.</b> The compare-and-exchange 8 bytes (64 bits) instruction is supported (implicitly locked and atomic).
9	APIC	<b>APIC On-Chip.</b> The processor contains an Advanced Programmable Interrupt Controller (APIC), responding to memory mapped commands in the physical address range FFFE0000H to FFFE0FFFH (by default - some processors permit the APIC to be relocated).
10	Reserved	Reserved
11	SEP	<b>SYSENTER and SYSEXIT Instructions.</b> The SYSENTER and SYSEXIT and associated MSRs are supported.
12	MTRR	<b>Memory Type Range Registers.</b> MTRRs are supported. The MTRRcap MSR contains feature bits that describe what memory types are supported, how many variable MTRRs are supported, and whether fixed MTRRs are supported.
13	PGE	<b>Page Global Bit.</b> The global bit is supported in paging-structure entries that map a page, indicating TLB entries that are common to different processes and need not be flushed. The CR4.PGE bit controls this feature.
14	MCA	<b>Machine Check Architecture.</b> A value of 1 indicates the Machine Check Architecture of reporting machine errors is supported. The MCG_CAP MSR contains feature bits describing how many banks of error reporting MSRs are supported.
15	CMOV	<b>Conditional Move Instructions.</b> The conditional move instruction CMOV is supported. In addition, if x87 FPU is present as indicated by the CPUID.FPU feature bit, then the FCOMI and FCMOV instructions are supported
16	PAT	<b>Page Attribute Table.</b> Page Attribute Table is supported. This feature augments the Memory Type Range Registers (MTRRs), allowing an operating system to specify attributes of memory accessed through a linear address on a 4KB granularity.
17	PSE-36	<b>36-Bit Page Size Extension.</b> 4-MByte pages addressing physical memory beyond 4 GBytes are supported with 32-bit paging. This feature indicates that upper bits of the physical address of a 4-MByte page are encoded in bits 20:13 of the page-directory entry. Such physical addresses are limited by MAXPHYADDR and may be up to 40 bits in size.
18	PSN	<b>Processor Serial Number.</b> The processor supports the 96-bit processor identification number feature and the feature is enabled.
19	CLFSH	<b>CLFLUSH Instruction.</b> CLFLUSH Instruction is supported.
20	Reserved	Reserved

**Table 3-11. More on Feature Information Returned in the EDX Register (Contd.)**

Bit #	Mnemonic	Description
21	DS	<b>Debug Store.</b> The processor supports the ability to write debug information into a memory resident buffer. This feature is used by the branch trace store (BTS) and processor event-based sampling (PEBS) facilities (see Chapter 23, "Introduction to Virtual-Machine Extensions," in the <i>Intel® 64 and IA-32 Architectures Software Developer's Manual, Volume 3C</i> ).
22	ACPI	<b>Thermal Monitor and Software Controlled Clock Facilities.</b> The processor implements internal MSRs that allow processor temperature to be monitored and processor performance to be modulated in predefined duty cycles under software control.
23	MMX	<b>Intel MMX Technology.</b> The processor supports the Intel MMX technology.
24	FXSR	<b>FXSAVE and FXRSTOR Instructions.</b> The FXSAVE and FXRSTOR instructions are supported for fast save and restore of the floating point context. Presence of this bit also indicates that CR4.OSFXSR is available for an operating system to indicate that it supports the FXSAVE and FXRSTOR instructions.
25	SSE	<b>SSE.</b> The processor supports the SSE extensions.
26	SSE2	<b>SSE2.</b> The processor supports the SSE2 extensions.
27	SS	<b>Self Snoop.</b> The processor supports the management of conflicting memory types by performing a snoop of its own cache structure for transactions issued to the bus.
28	HTT	<b>Max APIC IDs reserved field is Valid.</b> A value of 0 for HTT indicates there is only a single logical processor in the package and software should assume only a single APIC ID is reserved. A value of 1 for HTT indicates the value in CPUID.1.EBX[23:16] (the Maximum number of addressable IDs for logical processors in this package) is valid for the package.
29	TM	<b>Thermal Monitor.</b> The processor implements the thermal monitor automatic thermal control circuitry (TCC).
30	Reserved	Reserved
31	PBE	<b>Pending Break Enable.</b> The processor supports the use of the FERR#/PBE# pin when the processor is in the stop-clock state (STPCLK# is asserted) to signal the processor that an interrupt is pending and that the processor should return to normal operation to handle the interrupt. Bit 10 (PBE enable) in the IA32_MISC_ENABLE MSR enables this capability.

**INPUT EAX = 02H: TLB/Cache/Prefetch Information Returned in EAX, EBX, ECX, EDX**

When CPUID executes with EAX set to 02H, the processor returns information about the processor's internal TLBs, cache and prefetch hardware in the EAX, EBX, ECX, and EDX registers. The information is reported in encoded form and fall into the following categories:

- The least-significant byte in register EAX (register AL) will always return 01H. Software should ignore this value and not interpret it as an informational descriptor.
- The most significant bit (bit 31) of each register indicates whether the register contains valid information (set to 0) or is reserved (set to 1).
- If a register contains valid information, the information is contained in 1 byte descriptors. There are four types of encoding values for the byte descriptor, the encoding type is noted in the second column of Table 3-12. Table 3-12 lists the encoding of these descriptors. Note that the order of descriptors in the EAX, EBX, ECX, and EDX registers is not defined; that is, specific bytes are not designated to contain descriptors for specific cache, prefetch, or TLB types. The descriptors may appear in any order. Note also a processor may report a general descriptor type (FFH) and not report any byte descriptor of "cache type" via CPUID leaf 2.

Table 3-12. Encoding of CPUID Leaf 2 Descriptors

Value	Type	Description
00H	General	Null descriptor, this byte contains no information
01H	TLB	Instruction TLB: 4 KByte pages, 4-way set associative, 32 entries
02H	TLB	Instruction TLB: 4 MByte pages, fully associative, 2 entries
03H	TLB	Data TLB: 4 KByte pages, 4-way set associative, 64 entries
04H	TLB	Data TLB: 4 MByte pages, 4-way set associative, 8 entries
05H	TLB	Data TLB1: 4 MByte pages, 4-way set associative, 32 entries
06H	Cache	1st-level instruction cache: 8 KBytes, 4-way set associative, 32 byte line size
08H	Cache	1st-level instruction cache: 16 KBytes, 4-way set associative, 32 byte line size
09H	Cache	1st-level instruction cache: 32KBytes, 4-way set associative, 64 byte line size
0AH	Cache	1st-level data cache: 8 KBytes, 2-way set associative, 32 byte line size
0BH	TLB	Instruction TLB: 4 MByte pages, 4-way set associative, 4 entries
0CH	Cache	1st-level data cache: 16 KBytes, 4-way set associative, 32 byte line size
0DH	Cache	1st-level data cache: 16 KBytes, 4-way set associative, 64 byte line size
0EH	Cache	1st-level data cache: 24 KBytes, 6-way set associative, 64 byte line size
1DH	Cache	2nd-level cache: 128 KBytes, 2-way set associative, 64 byte line size
21H	Cache	2nd-level cache: 256 KBytes, 8-way set associative, 64 byte line size
22H	Cache	3rd-level cache: 512 KBytes, 4-way set associative, 64 byte line size, 2 lines per sector
23H	Cache	3rd-level cache: 1 MBytes, 8-way set associative, 64 byte line size, 2 lines per sector
24H	Cache	2nd-level cache: 1 MBytes, 16-way set associative, 64 byte line size
25H	Cache	3rd-level cache: 2 MBytes, 8-way set associative, 64 byte line size, 2 lines per sector
29H	Cache	3rd-level cache: 4 MBytes, 8-way set associative, 64 byte line size, 2 lines per sector
2CH	Cache	1st-level data cache: 32 KBytes, 8-way set associative, 64 byte line size
30H	Cache	1st-level instruction cache: 32 KBytes, 8-way set associative, 64 byte line size
40H	Cache	No 2nd-level cache or, if processor contains a valid 2nd-level cache, no 3rd-level cache
41H	Cache	2nd-level cache: 128 KBytes, 4-way set associative, 32 byte line size
42H	Cache	2nd-level cache: 256 KBytes, 4-way set associative, 32 byte line size
43H	Cache	2nd-level cache: 512 KBytes, 4-way set associative, 32 byte line size
44H	Cache	2nd-level cache: 1 MByte, 4-way set associative, 32 byte line size
45H	Cache	2nd-level cache: 2 MByte, 4-way set associative, 32 byte line size
46H	Cache	3rd-level cache: 4 MByte, 4-way set associative, 64 byte line size
47H	Cache	3rd-level cache: 8 MByte, 8-way set associative, 64 byte line size
48H	Cache	2nd-level cache: 3MByte, 12-way set associative, 64 byte line size
49H	Cache	3rd-level cache: 4MB, 16-way set associative, 64-byte line size (Intel Xeon processor MP, Family 0FH, Model 06H); 2nd-level cache: 4 MByte, 16-way set associative, 64 byte line size
4AH	Cache	3rd-level cache: 6MByte, 12-way set associative, 64 byte line size
4BH	Cache	3rd-level cache: 8MByte, 16-way set associative, 64 byte line size
4CH	Cache	3rd-level cache: 12MByte, 12-way set associative, 64 byte line size
4DH	Cache	3rd-level cache: 16MByte, 16-way set associative, 64 byte line size
4EH	Cache	2nd-level cache: 6MByte, 24-way set associative, 64 byte line size
4FH	TLB	Instruction TLB: 4 KByte pages, 32 entries

Table 3-12. Encoding of CPUID Leaf 2 Descriptors (Contd.)

Value	Type	Description
50H	TLB	Instruction TLB: 4 KByte and 2-MByte or 4-MByte pages, 64 entries
51H	TLB	Instruction TLB: 4 KByte and 2-MByte or 4-MByte pages, 128 entries
52H	TLB	Instruction TLB: 4 KByte and 2-MByte or 4-MByte pages, 256 entries
55H	TLB	Instruction TLB: 2-MByte or 4-MByte pages, fully associative, 7 entries
56H	TLB	Data TLB0: 4 MByte pages, 4-way set associative, 16 entries
57H	TLB	Data TLB0: 4 KByte pages, 4-way associative, 16 entries
59H	TLB	Data TLB0: 4 KByte pages, fully associative, 16 entries
5AH	TLB	Data TLB0: 2 MByte or 4 MByte pages, 4-way set associative, 32 entries
5BH	TLB	Data TLB: 4 KByte and 4 MByte pages, 64 entries
5CH	TLB	Data TLB: 4 KByte and 4 MByte pages, 128 entries
5DH	TLB	Data TLB: 4 KByte and 4 MByte pages, 256 entries
60H	Cache	1st-level data cache: 16 KByte, 8-way set associative, 64 byte line size
61H	TLB	Instruction TLB: 4 KByte pages, fully associative, 48 entries
63H	TLB	Data TLB: 2 MByte or 4 MByte pages, 4-way set associative, 32 entries and a separate array with 1 GByte pages, 4-way set associative, 4 entries
64H	TLB	Data TLB: 4 KByte pages, 4-way set associative, 512 entries
66H	Cache	1st-level data cache: 8 KByte, 4-way set associative, 64 byte line size
67H	Cache	1st-level data cache: 16 KByte, 4-way set associative, 64 byte line size
68H	Cache	1st-level data cache: 32 KByte, 4-way set associative, 64 byte line size
6AH	Cache	uTLB: 4 KByte pages, 8-way set associative, 64 entries
6BH	Cache	DTLB: 4 KByte pages, 8-way set associative, 256 entries
6CH	Cache	DTLB: 2M/4M pages, 8-way set associative, 128 entries
6DH	Cache	DTLB: 1 GByte pages, fully associative, 16 entries
70H	Cache	Trace cache: 12 K- $\mu$ op, 8-way set associative
71H	Cache	Trace cache: 16 K- $\mu$ op, 8-way set associative
72H	Cache	Trace cache: 32 K- $\mu$ op, 8-way set associative
76H	TLB	Instruction TLB: 2M/4M pages, fully associative, 8 entries
78H	Cache	2nd-level cache: 1 MByte, 4-way set associative, 64byte line size
79H	Cache	2nd-level cache: 128 KByte, 8-way set associative, 64 byte line size, 2 lines per sector
7AH	Cache	2nd-level cache: 256 KByte, 8-way set associative, 64 byte line size, 2 lines per sector
7BH	Cache	2nd-level cache: 512 KByte, 8-way set associative, 64 byte line size, 2 lines per sector
7CH	Cache	2nd-level cache: 1 MByte, 8-way set associative, 64 byte line size, 2 lines per sector
7DH	Cache	2nd-level cache: 2 MByte, 8-way set associative, 64byte line size
7FH	Cache	2nd-level cache: 512 KByte, 2-way set associative, 64-byte line size
80H	Cache	2nd-level cache: 512 KByte, 8-way set associative, 64-byte line size
82H	Cache	2nd-level cache: 256 KByte, 8-way set associative, 32 byte line size
83H	Cache	2nd-level cache: 512 KByte, 8-way set associative, 32 byte line size
84H	Cache	2nd-level cache: 1 MByte, 8-way set associative, 32 byte line size
85H	Cache	2nd-level cache: 2 MByte, 8-way set associative, 32 byte line size
86H	Cache	2nd-level cache: 512 KByte, 4-way set associative, 64 byte line size
87H	Cache	2nd-level cache: 1 MByte, 8-way set associative, 64 byte line size

Table 3-12. Encoding of CPUID Leaf 2 Descriptors (Contd.)

Value	Type	Description
A0H	DTLB	DTLB: 4k pages, fully associative, 32 entries
B0H	TLB	Instruction TLB: 4 KByte pages, 4-way set associative, 128 entries
B1H	TLB	Instruction TLB: 2M pages, 4-way, 8 entries or 4M pages, 4-way, 4 entries
B2H	TLB	Instruction TLB: 4KByte pages, 4-way set associative, 64 entries
B3H	TLB	Data TLB: 4 KByte pages, 4-way set associative, 128 entries
B4H	TLB	Data TLB1: 4 KByte pages, 4-way associative, 256 entries
B5H	TLB	Instruction TLB: 4KByte pages, 8-way set associative, 64 entries
B6H	TLB	Instruction TLB: 4KByte pages, 8-way set associative, 128 entries
BAH	TLB	Data TLB1: 4 KByte pages, 4-way associative, 64 entries
C0H	TLB	Data TLB: 4 KByte and 4 MByte pages, 4-way associative, 8 entries
C1H	STLB	Shared 2nd-Level TLB: 4 KByte/2MByte pages, 8-way associative, 1024 entries
C2H	DTLB	DTLB: 4 KByte/2 MByte pages, 4-way associative, 16 entries
C3H	STLB	Shared 2nd-Level TLB: 4 KByte /2 MByte pages, 6-way associative, 1536 entries. Also 1GByte pages, 4-way, 16 entries.
C4H	DTLB	DTLB: 2M/4M Byte pages, 4-way associative, 32 entries
CAH	STLB	Shared 2nd-Level TLB: 4 KByte pages, 4-way associative, 512 entries
D0H	Cache	3rd-level cache: 512 KByte, 4-way set associative, 64 byte line size
D1H	Cache	3rd-level cache: 1 MByte, 4-way set associative, 64 byte line size
D2H	Cache	3rd-level cache: 2 MByte, 4-way set associative, 64 byte line size
D6H	Cache	3rd-level cache: 1 MByte, 8-way set associative, 64 byte line size
D7H	Cache	3rd-level cache: 2 MByte, 8-way set associative, 64 byte line size
D8H	Cache	3rd-level cache: 4 MByte, 8-way set associative, 64 byte line size
DCH	Cache	3rd-level cache: 1.5 MByte, 12-way set associative, 64 byte line size
DDH	Cache	3rd-level cache: 3 MByte, 12-way set associative, 64 byte line size
DEH	Cache	3rd-level cache: 6 MByte, 12-way set associative, 64 byte line size
E2H	Cache	3rd-level cache: 2 MByte, 16-way set associative, 64 byte line size
E3H	Cache	3rd-level cache: 4 MByte, 16-way set associative, 64 byte line size
E4H	Cache	3rd-level cache: 8 MByte, 16-way set associative, 64 byte line size
EAH	Cache	3rd-level cache: 12MByte, 24-way set associative, 64 byte line size
EBH	Cache	3rd-level cache: 18MByte, 24-way set associative, 64 byte line size
ECH	Cache	3rd-level cache: 24MByte, 24-way set associative, 64 byte line size
FOH	Prefetch	64-Byte prefetching
F1H	Prefetch	128-Byte prefetching
FEH	General	CPUID leaf 2 does not report TLB descriptor information; use CPUID leaf 18H to query TLB and other address translation parameters.
FFH	General	CPUID leaf 2 does not report cache descriptor information, use CPUID leaf 4 to query cache parameters

### Example 3-1. Example of Cache and TLB Interpretation

The first member of the family of Pentium 4 processors returns the following information about caches and TLBs when the CPUID executes with an input value of 2:

```
EAX    66 5B 50 01H
EBX    0H
ECX    0H
EDX    00 7A 70 00H
```

Which means:

- The least-significant byte (byte 0) of register EAX is set to 01H. This value should be ignored.
- The most-significant bit of all four registers (EAX, EBX, ECX, and EDX) is set to 0, indicating that each register contains valid 1-byte descriptors.
- Bytes 1, 2, and 3 of register EAX indicate that the processor has:
  - 50H - a 64-entry instruction TLB, for mapping 4-KByte and 2-MByte or 4-MByte pages.
  - 5BH - a 64-entry data TLB, for mapping 4-KByte and 4-MByte pages.
  - 66H - an 8-KByte 1st level data cache, 4-way set associative, with a 64-Byte cache line size.
- The descriptors in registers EBX and ECX are valid, but contain NULL descriptors.
- Bytes 0, 1, 2, and 3 of register EDX indicate that the processor has:
  - 00H - NULL descriptor.
  - 70H - Trace cache: 12 K- $\mu$ op, 8-way set associative.
  - 7AH - a 256-KByte 2nd level cache, 8-way set associative, with a sectored, 64-byte cache line size.
  - 00H - NULL descriptor.

### INPUT EAX = 04H: Returns Deterministic Cache Parameters for Each Level

When CPUID executes with EAX set to 04H and ECX contains an index value, the processor returns encoded data that describe a set of deterministic cache parameters (for the cache level associated with the input in ECX). Valid index values start from 0.

Software can enumerate the deterministic cache parameters for each level of the cache hierarchy starting with an index value of 0, until the parameters report the value associated with the cache type field is 0. The architecturally defined fields reported by deterministic cache parameters are documented in Table 3-8.

This Cache Size in Bytes

$$= (\text{Ways} + 1) * (\text{Partitions} + 1) * (\text{Line\_Size} + 1) * (\text{Sets} + 1)$$

$$= (\text{EBX}[31:22] + 1) * (\text{EBX}[21:12] + 1) * (\text{EBX}[11:0] + 1) * (\text{ECX} + 1)$$

The CPUID leaf 04H also reports data that can be used to derive the topology of processor cores in a physical package. This information is constant for all valid index values. Software can query the raw data reported by executing CPUID with EAX=04H and ECX=0 and use it as part of the topology enumeration algorithm described in Chapter 8, "Multiple-Processor Management," in the *Intel® 64 and IA-32 Architectures Software Developer's Manual, Volume 3A*.

### INPUT EAX = 05H: Returns MONITOR and MWAIT Features

When CPUID executes with EAX set to 05H, the processor returns information about features available to MONITOR/MWAIT instructions. The MONITOR instruction is used for address-range monitoring in conjunction with MWAIT instruction. The MWAIT instruction optionally provides additional extensions for advanced power management. See Table 3-8.

### INPUT EAX = 06H: Returns Thermal and Power Management Features

When CPUID executes with EAX set to 06H, the processor returns information about thermal and power management features. See Table 3-8.

**INPUT EAX = 07H: Returns Structured Extended Feature Enumeration Information**

When CPUID executes with EAX set to 07H and ECX = 0, the processor returns information about the maximum input value for sub-leaves that contain extended feature flags. See Table 3-8.

When CPUID executes with EAX set to 07H and the input value of ECX is invalid (see leaf 07H entry in Table 3-8), the processor returns 0 in EAX/EBX/ECX/EDX. In subleaf 0, EAX returns the maximum input value of the highest leaf 7 sub-leaf, and EBX, ECX & EDX contain information of extended feature flags.

**INPUT EAX = 09H: Returns Direct Cache Access Information**

When CPUID executes with EAX set to 09H, the processor returns information about Direct Cache Access capabilities. See Table 3-8.

**INPUT EAX = 0AH: Returns Architectural Performance Monitoring Features**

When CPUID executes with EAX set to 0AH, the processor returns information about support for architectural performance monitoring capabilities. Architectural performance monitoring is supported if the version ID (see Table 3-8) is greater than Pn 0. See Table 3-8.

For each version of architectural performance monitoring capability, software must enumerate this leaf to discover the programming facilities and the architectural performance events available in the processor. The details are described in Chapter 23, "Introduction to Virtual-Machine Extensions," in the *Intel® 64 and IA-32 Architectures Software Developer's Manual, Volume 3C*.

**INPUT EAX = 0BH: Returns Extended Topology Information**

When CPUID executes with EAX set to 0BH, the processor returns information about extended topology enumeration data. Software must detect the presence of CPUID leaf 0BH by verifying (a) the highest leaf index supported by CPUID is  $\geq 0BH$ , and (b) CPUID.0BH:EBX[15:0] reports a non-zero value. See Table 3-8.

**INPUT EAX = 0DH: Returns Processor Extended States Enumeration Information**

When CPUID executes with EAX set to 0DH and ECX = 0, the processor returns information about the bit-vector representation of all processor state extensions that are supported in the processor and storage size requirements of the XSAVE/XRSTOR area. See Table 3-8.

When CPUID executes with EAX set to 0DH and ECX = n ( $n > 1$ , and is a valid sub-leaf index), the processor returns information about the size and offset of each processor extended state save area within the XSAVE/XRSTOR area. See Table 3-8. Software can use the forward-extendable technique depicted below to query the valid sub-leaves and obtain size and offset information for each processor extended state save area:

```
For i = 2 to 62 // sub-leaf 1 is reserved
  IF (CPUID.(EAX=0DH, ECX=0):VECTOR[i] = 1 ) // VECTOR is the 64-bit value of EDX:EAX
    Execute CPUID.(EAX=0DH, ECX = i) to examine size and offset for sub-leaf i;
  FI;
```

**INPUT EAX = 0FH: Returns Intel Resource Director Technology (Intel RDT) Monitoring Enumeration Information**

When CPUID executes with EAX set to 0FH and ECX = 0, the processor returns information about the bit-vector representation of QoS monitoring resource types that are supported in the processor and maximum range of RMID values the processor can use to monitor of any supported resource types. Each bit, starting from bit 1, corresponds to a specific resource type if the bit is set. The bit position corresponds to the sub-leaf index (or ResID) that software must use to query QoS monitoring capability available for that type. See Table 3-8.

When CPUID executes with EAX set to 0FH and ECX = n ( $n \geq 1$ , and is a valid ResID), the processor returns information software can use to program IA32\_PQR\_ASSOC, IA32\_QM\_EVTSEL MSRs before reading QoS data from the IA32\_QM\_CTR MSR.

**INPUT EAX = 10H: Returns Intel Resource Director Technology (Intel RDT) Allocation Enumeration Information**

When CPUID executes with EAX set to 10H and ECX = 0, the processor returns information about the bit-vector representation of QoS Enforcement resource types that are supported in the processor. Each bit, starting from bit



1, corresponds to a specific resource type if the bit is set. The bit position corresponds to the sub-leaf index (or ResID) that software must use to query QoS enforcement capability available for that type. See Table 3-8.

When CPUID executes with EAX set to 10H and ECX = n (n >= 1, and is a valid ResID), the processor returns information about available classes of service and range of QoS mask MSRs that software can use to configure each class of services using capability bit masks in the QoS Mask registers, IA32\_resourceType\_Mask\_n.

#### **INPUT EAX = 12H: Returns Intel SGX Enumeration Information**

When CPUID executes with EAX set to 12H and ECX = 0H, the processor returns information about Intel SGX capabilities. See Table 3-8.

When CPUID executes with EAX set to 12H and ECX = 1H, the processor returns information about Intel SGX attributes. See Table 3-8.

When CPUID executes with EAX set to 12H and ECX = n (n > 1), the processor returns information about Intel SGX Enclave Page Cache. See Table 3-8.

#### **INPUT EAX = 14H: Returns Intel Processor Trace Enumeration Information**

When CPUID executes with EAX set to 14H and ECX = 0H, the processor returns information about Intel Processor Trace extensions. See Table 3-8.

When CPUID executes with EAX set to 14H and ECX = n (n > 0 and less than the number of non-zero bits in CPUID.(EAX=14H, ECX= 0H).EAX), the processor returns information about packet generation in Intel Processor Trace. See Table 3-8.

#### **INPUT EAX = 15H: Returns Time Stamp Counter and Nominal Core Crystal Clock Information**

When CPUID executes with EAX set to 15H and ECX = 0H, the processor returns information about Time Stamp Counter and Core Crystal Clock. See Table 3-8.

#### **INPUT EAX = 16H: Returns Processor Frequency Information**

When CPUID executes with EAX set to 16H, the processor returns information about Processor Frequency Information. See Table 3-8.

#### **INPUT EAX = 17H: Returns System-On-Chip Information**

When CPUID executes with EAX set to 17H, the processor returns information about the System-On-Chip Vendor Attribute Enumeration. See Table 3-8.

#### **INPUT EAX = 18H: Returns Deterministic Address Translation Parameters Information**

When CPUID executes with EAX set to 18H, the processor returns information about the Deterministic Address Translation Parameters. See Table 3-8.

### **METHODS FOR RETURNING BRANDING INFORMATION**

Use the following techniques to access branding information:

1. Processor brand string method.
2. Processor brand index; this method uses a software supplied brand string table.

These two methods are discussed in the following sections. For methods that are available in early processors, see Section: "Identification of Earlier IA-32 Processors" in Chapter 19 of the *Intel® 64 and IA-32 Architectures Software Developer's Manual, Volume 1*.

#### **The Processor Brand String Method**

Figure 3-9 describes the algorithm used for detection of the brand string. Processor brand identification software should execute this algorithm on all Intel 64 and IA-32 processors.

This method (introduced with Pentium 4 processors) returns an ASCII brand identification string and the Processor Base frequency of the processor to the EAX, EBX, ECX, and EDX registers.

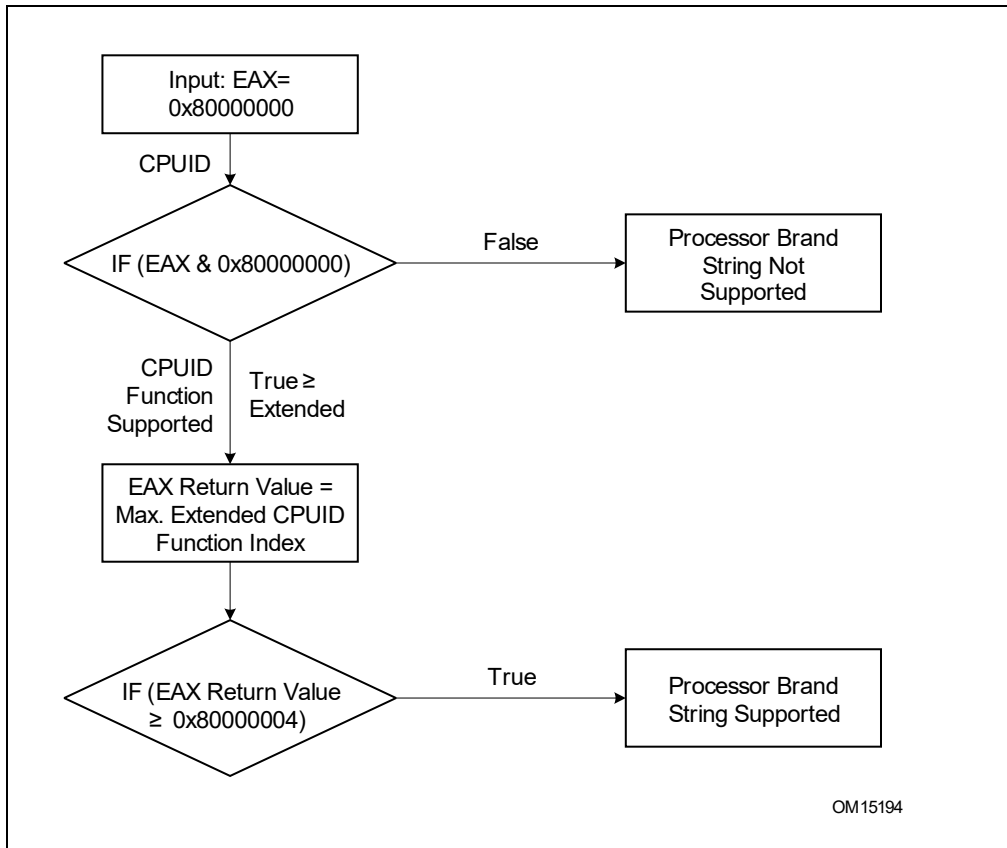

**Figure 3-9. Determination of Support for the Processor Brand String**

**How Brand Strings Work**

To use the brand string method, execute CPUID with EAX input of 8000002H through 80000004H. For each input value, CPUID returns 16 ASCII characters using EAX, EBX, ECX, and EDX. The returned string will be NULL-terminated.

Table 3-13 shows the brand string that is returned by the first processor in the Pentium 4 processor family.

**Table 3-13. Processor Brand String Returned with Pentium 4 Processor**

EAX Input Value	Return Values	ASCII Equivalent
80000002H	EAX = 20202020H EBX = 20202020H ECX = 20202020H EDX = 6E492020H	" " " " " " " " " "nl "
80000003H	EAX = 286C6574H EBX = 50202952H ECX = 69746E65H EDX = 52286D75H	"(let" "P )R" "itne" "R(mu"
80000004H	EAX = 20342029H EBX = 20555043H ECX = 30303531H EDX = 007A484DH	" 4 )" " UPC" "0051" "\0zHM"

### Extracting the Processor Frequency from Brand Strings

Figure 3-10 provides an algorithm which software can use to extract the Processor Base frequency from the processor brand string.

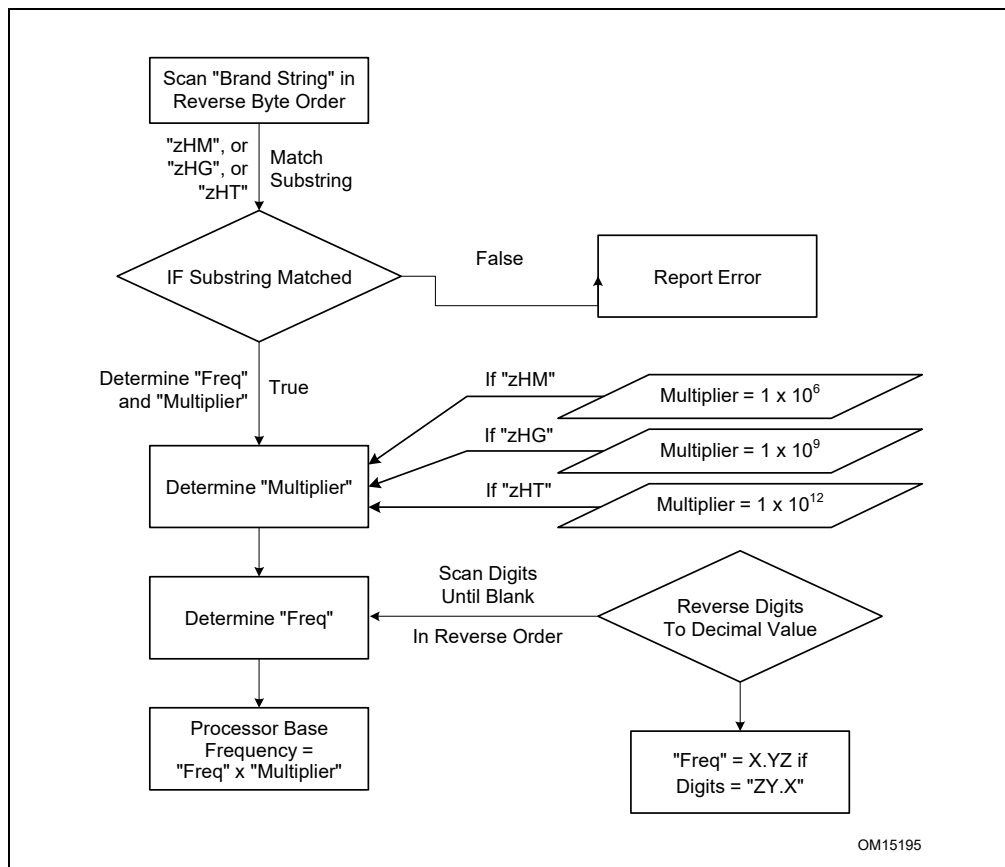

**Figure 3-10. Algorithm for Extracting Processor Frequency**

## The Processor Brand Index Method

The brand index method (introduced with Pentium® III Xeon® processors) provides an entry point into a brand identification table that is maintained in memory by system software and is accessible from system- and user-level code. In this table, each brand index is associate with an ASCII brand identification string that identifies the official Intel family and model number of a processor.

When CPUID executes with EAX set to 1, the processor returns a brand index to the low byte in EBX. Software can then use this index to locate the brand identification string for the processor in the brand identification table. The first entry (brand index 0) in this table is reserved, allowing for backward compatibility with processors that do not support the brand identification feature. Starting with processor signature family ID = 0FH, model = 03H, brand index method is no longer supported. Use brand string method instead.

Table 3-14 shows brand indices that have identification strings associated with them.

**Table 3-14. Mapping of Brand Indices; and Intel 64 and IA-32 Processor Brand Strings**

Brand Index	Brand String
00H	This processor does not support the brand identification feature
01H	Intel(R) Celeron(R) processor <sup>1</sup>
02H	Intel(R) Pentium(R) III processor <sup>1</sup>
03H	Intel(R) Pentium(R) III Xeon(R) processor; If processor signature = 000006B1h, then Intel(R) Celeron(R) processor
04H	Intel(R) Pentium(R) III processor
06H	Mobile Intel(R) Pentium(R) III processor-M
07H	Mobile Intel(R) Celeron(R) processor <sup>1</sup>
08H	Intel(R) Pentium(R) 4 processor
09H	Intel(R) Pentium(R) 4 processor
0AH	Intel(R) Celeron(R) processor <sup>1</sup>
0BH	Intel(R) Xeon(R) processor; If processor signature = 00000F13h, then Intel(R) Xeon(R) processor MP
0CH	Intel(R) Xeon(R) processor MP
0EH	Mobile Intel(R) Pentium(R) 4 processor-M; If processor signature = 00000F13h, then Intel(R) Xeon(R) processor
0FH	Mobile Intel(R) Celeron(R) processor <sup>1</sup>
11H	Mobile Genuine Intel(R) processor
12H	Intel(R) Celeron(R) M processor
13H	Mobile Intel(R) Celeron(R) processor <sup>1</sup>
14H	Intel(R) Celeron(R) processor
15H	Mobile Genuine Intel(R) processor
16H	Intel(R) Pentium(R) M processor
17H	Mobile Intel(R) Celeron(R) processor <sup>1</sup>
18H - 0FFH	RESERVED

### NOTES:

1. Indicates versions of these processors that were introduced after the Pentium III

## IA-32 Architecture Compatibility

CPUID is not supported in early models of the Intel486 processor or in any IA-32 processor earlier than the Intel486 processor.

## Operation

IA32\_BIOS\_SIGN\_ID MSR ← Update with installed microcode revision number;

CASE (EAX) OF

EAX = 0:

EAX ← Highest basic function input value understood by CPUID;

EBX ← Vendor identification string;

EDX ← Vendor identification string;

ECX ← Vendor identification string;

BREAK;

EAX = 1H:

EAX[3:0] ← Stepping ID;

EAX[7:4] ← Model;

EAX[11:8] ← Family;

EAX[13:12] ← Processor type;

EAX[15:14] ← Reserved;

EAX[19:16] ← Extended Model;

EAX[27:20] ← Extended Family;

EAX[31:28] ← Reserved;

EBX[7:0] ← Brand Index; (\* Reserved if the value is zero. \*)

EBX[15:8] ← CLFLUSH Line Size;

EBX[16:23] ← Reserved; (\* Number of threads enabled = 2 if MT enable fuse set. \*)

EBX[24:31] ← Initial APIC ID;

ECX ← Feature flags; (\* See Figure 3-7. \*)

EDX ← Feature flags; (\* See Figure 3-8. \*)

BREAK;

EAX = 2H:

EAX ← Cache and TLB information;

EBX ← Cache and TLB information;

ECX ← Cache and TLB information;

EDX ← Cache and TLB information;

BREAK;

EAX = 3H:

EAX ← Reserved;

EBX ← Reserved;

ECX ← ProcessorSerialNumber[31:0];

(\* Pentium III processors only, otherwise reserved. \*)

EDX ← ProcessorSerialNumber[63:32];

(\* Pentium III processors only, otherwise reserved. \*)

BREAK

EAX = 4H:

EAX ← Deterministic Cache Parameters Leaf; (\* See Table 3-8. \*)

EBX ← Deterministic Cache Parameters Leaf;

ECX ← Deterministic Cache Parameters Leaf;

EDX ← Deterministic Cache Parameters Leaf;

BREAK;

EAX = 5H:

EAX ← MONITOR/MWAIT Leaf; (\* See Table 3-8. \*)

EBX ← MONITOR/MWAIT Leaf;

ECX ← MONITOR/MWAIT Leaf;

EDX ← MONITOR/MWAIT Leaf;

BREAK;

EAX = 6H:

EAX ← Thermal and Power Management Leaf; (\* See Table 3-8. \*)  
 EBX ← Thermal and Power Management Leaf;  
 ECX ← Thermal and Power Management Leaf;  
 EDX ← Thermal and Power Management Leaf;

BREAK;

EAX = 7H:

EAX ← Structured Extended Feature Flags Enumeration Leaf; (\* See Table 3-8. \*)  
 EBX ← Structured Extended Feature Flags Enumeration Leaf;  
 ECX ← Structured Extended Feature Flags Enumeration Leaf;  
 EDX ← Structured Extended Feature Flags Enumeration Leaf;

BREAK;

EAX = 8H:

EAX ← Reserved = 0;  
 EBX ← Reserved = 0;  
 ECX ← Reserved = 0;  
 EDX ← Reserved = 0;

BREAK;

EAX = 9H:

EAX ← Direct Cache Access Information Leaf; (\* See Table 3-8. \*)  
 EBX ← Direct Cache Access Information Leaf;  
 ECX ← Direct Cache Access Information Leaf;  
 EDX ← Direct Cache Access Information Leaf;

BREAK;

EAX = AH:

EAX ← Architectural Performance Monitoring Leaf; (\* See Table 3-8. \*)  
 EBX ← Architectural Performance Monitoring Leaf;  
 ECX ← Architectural Performance Monitoring Leaf;  
 EDX ← Architectural Performance Monitoring Leaf;  
 BREAK

EAX = BH:

EAX ← Extended Topology Enumeration Leaf; (\* See Table 3-8. \*)  
 EBX ← Extended Topology Enumeration Leaf;  
 ECX ← Extended Topology Enumeration Leaf;  
 EDX ← Extended Topology Enumeration Leaf;

BREAK;

EAX = CH:

EAX ← Reserved = 0;  
 EBX ← Reserved = 0;  
 ECX ← Reserved = 0;  
 EDX ← Reserved = 0;

BREAK;

EAX = DH:

EAX ← Processor Extended State Enumeration Leaf; (\* See Table 3-8. \*)  
 EBX ← Processor Extended State Enumeration Leaf;  
 ECX ← Processor Extended State Enumeration Leaf;  
 EDX ← Processor Extended State Enumeration Leaf;

BREAK;

EAX = EH:

EAX ← Reserved = 0;  
 EBX ← Reserved = 0;  
 ECX ← Reserved = 0;  
 EDX ← Reserved = 0;

BREAK;

EAX = FH:

EAX ← Intel Resource Director Technology Monitoring Enumeration Leaf; (\* See Table 3-8. \*)

EBX ← Intel Resource Director Technology Monitoring Enumeration Leaf;

ECX ← Intel Resource Director Technology Monitoring Enumeration Leaf;

EDX ← Intel Resource Director Technology Monitoring Enumeration Leaf;

BREAK;

EAX = 10H:

EAX ← Intel Resource Director Technology Allocation Enumeration Leaf; (\* See Table 3-8. \*)

EBX ← Intel Resource Director Technology Allocation Enumeration Leaf;

ECX ← Intel Resource Director Technology Allocation Enumeration Leaf;

EDX ← Intel Resource Director Technology Allocation Enumeration Leaf;

BREAK;

EAX = 12H:

EAX ← Intel SGX Enumeration Leaf; (\* See Table 3-8. \*)

EBX ← Intel SGX Enumeration Leaf;

ECX ← Intel SGX Enumeration Leaf;

EDX ← Intel SGX Enumeration Leaf;

BREAK;

EAX = 14H:

EAX ← Intel Processor Trace Enumeration Leaf; (\* See Table 3-8. \*)

EBX ← Intel Processor Trace Enumeration Leaf;

ECX ← Intel Processor Trace Enumeration Leaf;

EDX ← Intel Processor Trace Enumeration Leaf;

BREAK;

EAX = 15H:

EAX ← Time Stamp Counter and Nominal Core Crystal Clock Information Leaf; (\* See Table 3-8. \*)

EBX ← Time Stamp Counter and Nominal Core Crystal Clock Information Leaf;

ECX ← Time Stamp Counter and Nominal Core Crystal Clock Information Leaf;

EDX ← Time Stamp Counter and Nominal Core Crystal Clock Information Leaf;

BREAK;

EAX = 16H:

EAX ← Processor Frequency Information Enumeration Leaf; (\* See Table 3-8. \*)

EBX ← Processor Frequency Information Enumeration Leaf;

ECX ← Processor Frequency Information Enumeration Leaf;

EDX ← Processor Frequency Information Enumeration Leaf;

BREAK;

EAX = 17H:

EAX ← System-On-Chip Vendor Attribute Enumeration Leaf; (\* See Table 3-8. \*)

EBX ← System-On-Chip Vendor Attribute Enumeration Leaf;

ECX ← System-On-Chip Vendor Attribute Enumeration Leaf;

EDX ← System-On-Chip Vendor Attribute Enumeration Leaf;

BREAK;

EAX = 18H:

EAX ← Deterministic Address Translation Parameters Enumeration Leaf; (\* See Table 3-8. \*)

EBX ← Deterministic Address Translation Parameters Enumeration Leaf;

ECX ← Deterministic Address Translation Parameters Enumeration Leaf;

EDX ← Deterministic Address Translation Parameters Enumeration Leaf;

BREAK;

EAX = 80000000H:

EAX ← Highest extended function input value understood by CPUID;

EBX ← Reserved;

ECX ← Reserved;

EDX ← Reserved;

BREAK;

EAX = 80000001H:

EAX ← Reserved;

EBX ← Reserved;

ECX ← Extended Feature Bits (\* See Table 3-8.\*);

EDX ← Extended Feature Bits (\* See Table 3-8. \*);

BREAK;

EAX = 80000002H:

EAX ← Processor Brand String;

EBX ← Processor Brand String, continued;

ECX ← Processor Brand String, continued;

EDX ← Processor Brand String, continued;

BREAK;

EAX = 80000003H:

EAX ← Processor Brand String, continued;

EBX ← Processor Brand String, continued;

ECX ← Processor Brand String, continued;

EDX ← Processor Brand String, continued;

BREAK;

EAX = 80000004H:

EAX ← Processor Brand String, continued;

EBX ← Processor Brand String, continued;

ECX ← Processor Brand String, continued;

EDX ← Processor Brand String, continued;

BREAK;

EAX = 80000005H:

EAX ← Reserved = 0;

EBX ← Reserved = 0;

ECX ← Reserved = 0;

EDX ← Reserved = 0;

BREAK;

EAX = 80000006H:

EAX ← Reserved = 0;

EBX ← Reserved = 0;

ECX ← Cache information;

EDX ← Reserved = 0;

BREAK;

EAX = 80000007H:

EAX ← Reserved = 0;

EBX ← Reserved = 0;

ECX ← Reserved = 0;

EDX ← Reserved = Misc Feature Flags;

BREAK;

EAX = 80000008H:

EAX ← Reserved = Physical Address Size Information;

EBX ← Reserved = Virtual Address Size Information;

ECX ← Reserved = 0;

EDX ← Reserved = 0;

BREAK;

EAX >= 40000000H and EAX <= 4FFFFFFFH:

DEFAULT: (\* EAX = Value outside of recognized range for CPUID. \*)

(\* If the highest basic information leaf data depend on ECX input value, ECX is honored.\*)

EAX ← Reserved; (\* Information returned for highest basic information leaf. \*)

EBX ← Reserved; (\* Information returned for highest basic information leaf. \*)

ECX ← Reserved; (\* Information returned for highest basic information leaf. \*)



EDX ← Reserved; (\* Information returned for highest basic information leaf. \*)  
BREAK;  
ESAC;

### Flags Affected

None.

### Exceptions (All Operating Modes)

#UD                    If the LOCK prefix is used.  
In earlier IA-32 processors that do not support the CPUID instruction, execution of the instruction results in an invalid opcode (#UD) exception being generated.

## CRC32 – Accumulate CRC32 Value

Opcode/ Instruction	Op/ En	64-Bit Mode	Compat/ Leg Mode	Description
F2 0F 38 F0 /r CRC32 r32, r/m8	RM	Valid	Valid	Accumulate CRC32 on r/m8.
F2 REX 0F 38 F0 /r CRC32 r32, r/m8*	RM	Valid	N.E.	Accumulate CRC32 on r/m8.
F2 0F 38 F1 /r CRC32 r32, r/m16	RM	Valid	Valid	Accumulate CRC32 on r/m16.
F2 0F 38 F1 /r CRC32 r32, r/m32	RM	Valid	Valid	Accumulate CRC32 on r/m32.
F2 REX.W 0F 38 F0 /r CRC32 r64, r/m8	RM	Valid	N.E.	Accumulate CRC32 on r/m8.
F2 REX.W 0F 38 F1 /r CRC32 r64, r/m64	RM	Valid	N.E.	Accumulate CRC32 on r/m64.

### NOTES:

\*In 64-bit mode, r/m8 can not be encoded to access the following byte registers if a REX prefix is used: AH, BH, CH, DH.

### Instruction Operand Encoding

Op/En	Operand 1	Operand 2	Operand 3	Operand 4
RM	ModRM:reg (r, w)	ModRM:r/m (r)	NA	NA

### Description

Starting with an initial value in the first operand (destination operand), accumulates a CRC32 (polynomial 11EDC6F41H) value for the second operand (source operand) and stores the result in the destination operand. The source operand can be a register or a memory location. The destination operand must be an r32 or r64 register. If the destination is an r64 register, then the 32-bit result is stored in the least significant double word and 00000000H is stored in the most significant double word of the r64 register.

The initial value supplied in the destination operand is a double word integer stored in the r32 register or the least significant double word of the r64 register. To incrementally accumulate a CRC32 value, software retains the result of the previous CRC32 operation in the destination operand, then executes the CRC32 instruction again with new input data in the source operand. Data contained in the source operand is processed in reflected bit order. This means that the most significant bit of the source operand is treated as the least significant bit of the quotient, and so on, for all the bits of the source operand. Likewise, the result of the CRC operation is stored in the destination operand in reflected bit order. This means that the most significant bit of the resulting CRC (bit 31) is stored in the least significant bit of the destination operand (bit 0), and so on, for all the bits of the CRC.

### Operation

#### Notes:

BIT\_REFLECT64: DST[63-0] = SRC[0-63]  
 BIT\_REFLECT32: DST[31-0] = SRC[0-31]  
 BIT\_REFLECT16: DST[15-0] = SRC[0-15]  
 BIT\_REFLECT8: DST[7-0] = SRC[0-7]  
 MOD2: Remainder from Polynomial division modulus 2

CRC32 instruction for 64-bit source operand and 64-bit destination operand:

```

TEMP1[63-0] ← BIT_REFLECT64 (SRC[63-0])
TEMP2[31-0] ← BIT_REFLECT32 (DEST[31-0])
TEMP3[95-0] ← TEMP1[63-0] ‹ 32
TEMP4[95-0] ← TEMP2[31-0] ‹ 64
TEMP5[95-0] ← TEMP3[95-0] XOR TEMP4[95-0]
TEMP6[31-0] ← TEMP5[95-0] MOD2 11EDC6F41H
DEST[31-0] ← BIT_REFLECT (TEMP6[31-0])
DEST[63-32] ← 00000000H

```

CRC32 instruction for 32-bit source operand and 32-bit destination operand:

```

TEMP1[31-0] ← BIT_REFLECT32 (SRC[31-0])
TEMP2[31-0] ← BIT_REFLECT32 (DEST[31-0])
TEMP3[63-0] ← TEMP1[31-0] ‹ 32
TEMP4[63-0] ← TEMP2[31-0] ‹ 32
TEMP5[63-0] ← TEMP3[63-0] XOR TEMP4[63-0]
TEMP6[31-0] ← TEMP5[63-0] MOD2 11EDC6F41H
DEST[31-0] ← BIT_REFLECT (TEMP6[31-0])

```

CRC32 instruction for 16-bit source operand and 32-bit destination operand:

```

TEMP1[15-0] ← BIT_REFLECT16 (SRC[15-0])
TEMP2[31-0] ← BIT_REFLECT32 (DEST[31-0])
TEMP3[47-0] ← TEMP1[15-0] ‹ 32
TEMP4[47-0] ← TEMP2[31-0] ‹ 16
TEMP5[47-0] ← TEMP3[47-0] XOR TEMP4[47-0]
TEMP6[31-0] ← TEMP5[47-0] MOD2 11EDC6F41H
DEST[31-0] ← BIT_REFLECT (TEMP6[31-0])

```

CRC32 instruction for 8-bit source operand and 64-bit destination operand:

```

TEMP1[7-0] ← BIT_REFLECT8(SRC[7-0])
TEMP2[31-0] ← BIT_REFLECT32 (DEST[31-0])
TEMP3[39-0] ← TEMP1[7-0] ‹ 32
TEMP4[39-0] ← TEMP2[31-0] ‹ 8
TEMP5[39-0] ← TEMP3[39-0] XOR TEMP4[39-0]
TEMP6[31-0] ← TEMP5[39-0] MOD2 11EDC6F41H
DEST[31-0] ← BIT_REFLECT (TEMP6[31-0])
DEST[63-32] ← 00000000H

```

CRC32 instruction for 8-bit source operand and 32-bit destination operand:

```

TEMP1[7-0] ← BIT_REFLECT8(SRC[7-0])
TEMP2[31-0] ← BIT_REFLECT32 (DEST[31-0])
TEMP3[39-0] ← TEMP1[7-0] ‹ 32
TEMP4[39-0] ← TEMP2[31-0] ‹ 8
TEMP5[39-0] ← TEMP3[39-0] XOR TEMP4[39-0]
TEMP6[31-0] ← TEMP5[39-0] MOD2 11EDC6F41H
DEST[31-0] ← BIT_REFLECT (TEMP6[31-0])

```

### Flags Affected

None

**Intel C/C++ Compiler Intrinsic Equivalent**

unsigned int \_mm\_crc32\_u8( unsigned int crc, unsigned char data )  
 unsigned int \_mm\_crc32\_u16( unsigned int crc, unsigned short data )  
 unsigned int \_mm\_crc32\_u32( unsigned int crc, unsigned int data )  
 unsigned \_\_int64 \_mm\_crc32\_u64( unsigned \_\_int64 crc, unsigned \_\_int64 data )

**SIMD Floating Point Exceptions**

None

**Protected Mode Exceptions**

#GP(0) If a memory operand effective address is outside the CS, DS, ES, FS or GS segments.  
 #SS(0) If a memory operand effective address is outside the SS segment limit.  
 #PF (fault-code) For a page fault.  
 #AC(0) If alignment checking is enabled and an unaligned memory reference is made while the current privilege level is 3.  
 #UD If CPUID.01H:ECX.SSE4\_2 [Bit 20] = 0.  
 If LOCK prefix is used.

**Real-Address Mode Exceptions**

#GP(0) If any part of the operand lies outside of the effective address space from 0 to 0FFFFH.  
 #SS(0) If a memory operand effective address is outside the SS segment limit.  
 #UD If CPUID.01H:ECX.SSE4\_2 [Bit 20] = 0.  
 If LOCK prefix is used.

**Virtual 8086 Mode Exceptions**

#GP(0) If any part of the operand lies outside of the effective address space from 0 to 0FFFFH.  
 #SS(0) If a memory operand effective address is outside the SS segment limit.  
 #PF (fault-code) For a page fault.  
 #AC(0) If alignment checking is enabled and an unaligned memory reference is made.  
 #UD If CPUID.01H:ECX.SSE4\_2 [Bit 20] = 0.  
 If LOCK prefix is used.

**Compatibility Mode Exceptions**

Same exceptions as in Protected Mode.

**64-Bit Mode Exceptions**

#GP(0) If the memory address is in a non-canonical form.  
 #SS(0) If a memory address referencing the SS segment is in a non-canonical form.  
 #PF (fault-code) For a page fault.  
 #AC(0) If alignment checking is enabled and an unaligned memory reference is made while the current privilege level is 3.  
 #UD If CPUID.01H:ECX.SSE4\_2 [Bit 20] = 0.  
 If LOCK prefix is used.

## CVTDQ2PD—Convert Packed Doubleword Integers to Packed Double-Precision Floating-Point Values

Opcode/ Instruction	Op / En	64/32 bit Mode Support	CPUID Feature Flag	Description
F3 0F E6 /r CVTDQ2PD xmm1, xmm2/m64	A	V/V	SSE2	Convert two packed signed doubleword integers from xmm2/mem to two packed double-precision floating-point values in xmm1.
VEX.128.F3.0F.WIG E6 /r VCVTDQ2PD xmm1, xmm2/m64	A	V/V	AVX	Convert two packed signed doubleword integers from xmm2/mem to two packed double-precision floating-point values in xmm1.
VEX.256.F3.0F.WIG E6 /r VCVTDQ2PD ymm1, xmm2/m128	A	V/V	AVX	Convert four packed signed doubleword integers from xmm2/mem to four packed double-precision floating-point values in ymm1.
EVEX.128.F3.0F.W0 E6 /r VCVTDQ2PD xmm1 {k1}{z}, xmm2/m128/m32bcst	B	V/V	AVX512VL AVX512F	Convert 2 packed signed doubleword integers from xmm2/m128/m32bcst to eight packed double-precision floating-point values in xmm1 with writemask k1.
EVEX.256.F3.0F.W0 E6 /r VCVTDQ2PD ymm1 {k1}{z}, xmm2/m128/m32bcst	B	V/V	AVX512VL AVX512F	Convert 4 packed signed doubleword integers from xmm2/m128/m32bcst to 4 packed double-precision floating-point values in ymm1 with writemask k1.
EVEX.512.F3.0F.W0 E6 /r VCVTDQ2PD zmm1 {k1}{z}, ymm2/m256/m32bcst	B	V/V	AVX512F	Convert eight packed signed doubleword integers from ymm2/m256/m32bcst to eight packed double-precision floating-point values in zmm1 with writemask k1.

### Instruction Operand Encoding

Op/En	Tuple Type	Operand 1	Operand 2	Operand 3	Operand 4
A	NA	ModRM:reg (w)	ModRM:r/m (r)	NA	NA
B	Half	ModRM:reg (w)	ModRM:r/m (r)	NA	NA

### Description

Converts two, four or eight packed signed doubleword integers in the source operand (the second operand) to two, four or eight packed double-precision floating-point values in the destination operand (the first operand).

EVEX encoded versions: The source operand can be a YMM/XMM/XMM (low 64 bits) register, a 256/128/64-bit memory location or a 256/128/64-bit vector broadcasted from a 32-bit memory location. The destination operand is a ZMM/YMM/XMM register conditionally updated with writemask k1. Attempt to encode this instruction with EVEX embedded rounding is ignored.

VEX.256 encoded version: The source operand is an XMM register or 128-bit memory location. The destination operand is a YMM register.

VEX.128 encoded version: The source operand is an XMM register or 64-bit memory location. The destination operand is a XMM register. The upper Bits (MAXVL-1:128) of the corresponding ZMM register destination are zeroed.

128-bit Legacy SSE version: The source operand is an XMM register or 64-bit memory location. The destination operand is an XMM register. The upper Bits (MAXVL-1:128) of the corresponding ZMM register destination are unmodified.

VEX.vvvv and EVEX.vvvv are reserved and must be 1111b, otherwise instructions will #UD.

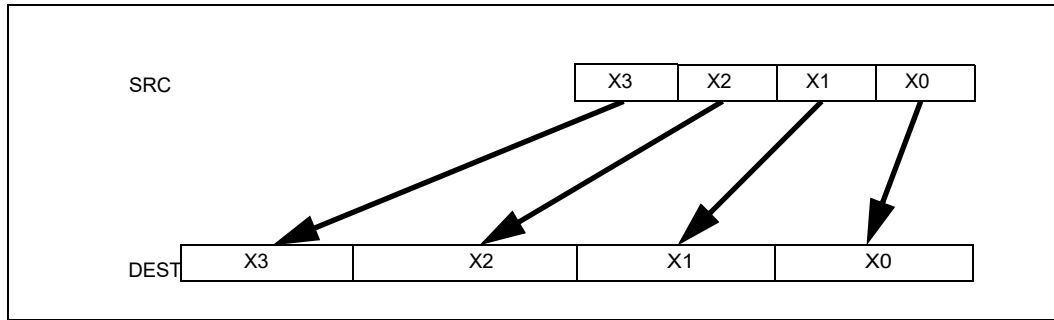

Figure 3-11. CVTDQ2PD (VEX.256 encoded version)

### Operation

**VCVTDQ2PD (EVEX encoded versions) when src operand is a register**

(KL, VL) = (2, 128), (4, 256), (8, 512)

FOR j ← 0 TO KL-1

  i ← j \* 64

  k ← j \* 32

  IF k1[j] OR \*no writemask\*

    THEN DEST[i+63:i] ←

      Convert\_Integer\_To\_Double\_Precision\_Floating\_Point(SRC[k+31:k])

  ELSE

    IF \*merging-masking\* ; merging-masking

      THEN \*DEST[i+63:i] remains unchanged\*

    ELSE ; zeroing-masking

      DEST[i+63:i] ← 0

  FI

FI;

ENDFOR

DEST[MAXVL-1:VL] ← 0

**VCVTDQ2PD (EVEX encoded versions) when src operand is a memory source**  
 (KL, VL) = (2, 128), (4, 256), (8, 512)

```

FOR j ← 0 TO KL-1
  i ← j * 64
  k ← j * 32
  IF k1[j] OR *no writemask*
    THEN
      IF (EVEX.b = 1)
        THEN
          DEST[i+63:i] ←
          Convert_Integer_To_Double_Precision_Floating_Point(SRC[31:0])
        ELSE
          DEST[i+63:i] ←
          Convert_Integer_To_Double_Precision_Floating_Point(SRC[k+31:k])
      FI;
    ELSE
      IF *merging-masking*           ; merging-masking
        THEN *DEST[i+63:i] remains unchanged*
      ELSE                             ; zeroing-masking
        DEST[i+63:i] ← 0
      FI
    FI;
ENDFOR
DEST[MAXVL-1:VL] ← 0

```

**VCVTDQ2PD (VEX.256 encoded version)**

```

DEST[63:0] ← Convert_Integer_To_Double_Precision_Floating_Point(SRC[31:0])
DEST[127:64] ← Convert_Integer_To_Double_Precision_Floating_Point(SRC[63:32])
DEST[191:128] ← Convert_Integer_To_Double_Precision_Floating_Point(SRC[95:64])
DEST[255:192] ← Convert_Integer_To_Double_Precision_Floating_Point(SRC[127:96])
DEST[MAXVL-1:256] ← 0

```

**VCVTDQ2PD (VEX.128 encoded version)**

```

DEST[63:0] ← Convert_Integer_To_Double_Precision_Floating_Point(SRC[31:0])
DEST[127:64] ← Convert_Integer_To_Double_Precision_Floating_Point(SRC[63:32])
DEST[MAXVL-1:128] ← 0

```

**CVTDQ2PD (128-bit Legacy SSE version)**

```

DEST[63:0] ← Convert_Integer_To_Double_Precision_Floating_Point(SRC[31:0])
DEST[127:64] ← Convert_Integer_To_Double_Precision_Floating_Point(SRC[63:32])
DEST[MAXVL-1:128] (unmodified)

```

### Intel C/C++ Compiler Intrinsic Equivalent

```

VCVTDQ2PD __m512d __mm512_cvtepi32_pd( __m256i a);
VCVTDQ2PD __m512d __mm512_mask_cvtepi32_pd( __m512d s, __mmask8 k, __m256i a);
VCVTDQ2PD __m512d __mm512_maskz_cvtepi32_pd( __mmask8 k, __m256i a);
VCVTDQ2PD __m256d __mm256_cvtepi32_pd( __m128i src);
VCVTDQ2PD __m256d __mm256_mask_cvtepi32_pd( __m256d s, __mmask8 k, __m256i a);
VCVTDQ2PD __m256d __mm256_maskz_cvtepi32_pd( __mmask8 k, __m256i a);
VCVTDQ2PD __m128d __mm_mask_cvtepi32_pd( __m128d s, __mmask8 k, __m128i a);
VCVTDQ2PD __m128d __mm_maskz_cvtepi32_pd( __mmask8 k, __m128i a);
CVTDQ2PD __m128d __mm_cvtepi32_pd( __m128i src)

```

**Other Exceptions**

VEX-encoded instructions, see Exceptions Type 5;

EVEX-encoded instructions, see Exceptions Type E5.

#UD                      If VEX.vvvv != 1111B or EVEX.vvvv != 1111B.



## CVTDQ2PS—Convert Packed Doubleword Integers to Packed Single-Precision Floating-Point Values

Opcode Instruction	Op/En	64/32 bit Mode Support	CPUID Feature Flag	Description
NP.0F.5B /r CVTDQ2PS xmm1, xmm2/m128	A	V/V	SSE2	Convert four packed signed doubleword integers from xmm2/mem to four packed single-precision floating-point values in xmm1.
VEX.128.0F.WIG 5B /r VCVTDQ2PS xmm1, xmm2/m128	A	V/V	AVX	Convert four packed signed doubleword integers from xmm2/mem to four packed single-precision floating-point values in xmm1.
VEX.256.0F.WIG 5B /r VCVTDQ2PS ymm1, ymm2/m256	A	V/V	AVX	Convert eight packed signed doubleword integers from ymm2/mem to eight packed single-precision floating-point values in ymm1.
EVEX.128.0F.W0 5B /r VCVTDQ2PS xmm1 {k1}{z}, xmm2/m128/m32bcst	B	V/V	AVX512VL AVX512F	Convert four packed signed doubleword integers from xmm2/m128/m32bcst to four packed single-precision floating-point values in xmm1 with writemask k1.
EVEX.256.0F.W0 5B /r VCVTDQ2PS ymm1 {k1}{z}, ymm2/m256/m32bcst	B	V/V	AVX512VL AVX512F	Convert eight packed signed doubleword integers from ymm2/m256/m32bcst to eight packed single-precision floating-point values in ymm1 with writemask k1.
EVEX.512.0F.W0 5B /r VCVTDQ2PS zmm1 {k1}{z}, zmm2/m512/m32bcst{er}	B	V/V	AVX512F	Convert sixteen packed signed doubleword integers from zmm2/m512/m32bcst to sixteen packed single-precision floating-point values in zmm1 with writemask k1.

### Instruction Operand Encoding

Op/En	Tuple Type	Operand 1	Operand 2	Operand 3	Operand 4
A	NA	ModRM:reg (w)	ModRM:r/m (r)	NA	NA
B	Full	ModRM:reg (w)	ModRM:r/m (r)	NA	NA

### Description

Converts four, eight or sixteen packed signed doubleword integers in the source operand to four, eight or sixteen packed single-precision floating-point values in the destination operand.

EVEX encoded versions: The source operand can be a ZMM/YMM/XMM register, a 512/256/128-bit memory location or a 512/256/128-bit vector broadcasted from a 32-bit memory location. The destination operand is a ZMM/YMM/XMM register conditionally updated with writemask k1.

VEX.256 encoded version: The source operand is a YMM register or 256-bit memory location. The destination operand is a YMM register. Bits (MAXVL-1:256) of the corresponding register destination are zeroed.

VEX.128 encoded version: The source operand is an XMM register or 128-bit memory location. The destination operand is an XMM register. The upper bits (MAXVL-1:128) of the corresponding register destination are zeroed.

128-bit Legacy SSE version: The source operand is an XMM register or 128-bit memory location. The destination operand is an XMM register. The upper bits (MAXVL-1:128) of the corresponding register destination are unmodified.

VEX.vvvv and EVEX.vvvv are reserved and must be 1111b, otherwise instructions will #UD.

**Operation****VCVTDQ2PS (EVEX encoded versions) when SRC operand is a register**

(KL, VL) = (4, 128), (8, 256), (16, 512)

IF (VL = 512) AND (EVEX.b = 1)

THEN

SET\_RM(EVEX.RC); ; refer to Table 2-4 in the *Intel® Architecture Instruction Set Extensions Programming Reference*

ELSE

SET\_RM(MXCSR.RM); ; refer to Table 2-4 in the *Intel® Architecture Instruction Set Extensions Programming Reference*

FI;

FOR j ← 0 TO KL-1

i ← j \* 32

IF k1[j] OR \*no writemask\*

THEN DEST[i+31:i] ←

Convert\_Integer\_To\_Single\_Precision\_Floating\_Point(SRC[i+31:i])

ELSE

IF \*merging-masking\* ; merging-masking

THEN \*DEST[i+31:i] remains unchanged\*

ELSE ; zeroing-masking

DEST[i+31:i] ← 0

FI

FI;

ENDFOR

DEST[MAXVL-1:VL] ← 0

**VCVTDQ2PS (EVEX encoded versions) when SRC operand is a memory source**

(KL, VL) = (4, 128), (8, 256), (16, 512)

FOR j ← 0 TO KL-1

i ← j \* 32

IF k1[j] OR \*no writemask\*

THEN

IF (EVEX.b = 1)

THEN

DEST[i+31:i] ←

Convert\_Integer\_To\_Single\_Precision\_Floating\_Point(SRC[31:0])

ELSE

DEST[i+31:i] ←

Convert\_Integer\_To\_Single\_Precision\_Floating\_Point(SRC[i+31:i])

FI;

ELSE

IF \*merging-masking\* ; merging-masking

THEN \*DEST[i+31:i] remains unchanged\*

ELSE ; zeroing-masking

DEST[i+31:i] ← 0

FI

FI;

ENDFOR

DEST[MAXVL-1:VL] ← 0

**VCVTDQ2PS (VEX.256 encoded version)**

DEST[31:0] ← Convert\_Integer\_To\_Single\_Precision\_Floating\_Point(SRC[31:0])  
 DEST[63:32] ← Convert\_Integer\_To\_Single\_Precision\_Floating\_Point(SRC[63:32])  
 DEST[95:64] ← Convert\_Integer\_To\_Single\_Precision\_Floating\_Point(SRC[95:64])  
 DEST[127:96] ← Convert\_Integer\_To\_Single\_Precision\_Floating\_Point(SRC[127:96])  
 DEST[159:128] ← Convert\_Integer\_To\_Single\_Precision\_Floating\_Point(SRC[159:128])  
 DEST[191:160] ← Convert\_Integer\_To\_Single\_Precision\_Floating\_Point(SRC[191:160])  
 DEST[223:192] ← Convert\_Integer\_To\_Single\_Precision\_Floating\_Point(SRC[223:192])  
 DEST[255:224] ← Convert\_Integer\_To\_Single\_Precision\_Floating\_Point(SRC[255:224])  
 DEST[MAXVL-1:256] ← 0

**VCVTDQ2PS (VEX.128 encoded version)**

DEST[31:0] ← Convert\_Integer\_To\_Single\_Precision\_Floating\_Point(SRC[31:0])  
 DEST[63:32] ← Convert\_Integer\_To\_Single\_Precision\_Floating\_Point(SRC[63:32])  
 DEST[95:64] ← Convert\_Integer\_To\_Single\_Precision\_Floating\_Point(SRC[95:64])  
 DEST[127:96] ← Convert\_Integer\_To\_Single\_Precision\_Floating\_Point(SRC[127:96])  
 DEST[MAXVL-1:128] ← 0

**CVTDQ2PS (128-bit Legacy SSE version)**

DEST[31:0] ← Convert\_Integer\_To\_Single\_Precision\_Floating\_Point(SRC[31:0])  
 DEST[63:32] ← Convert\_Integer\_To\_Single\_Precision\_Floating\_Point(SRC[63:32])  
 DEST[95:64] ← Convert\_Integer\_To\_Single\_Precision\_Floating\_Point(SRC[95:64])  
 DEST[127:96] ← Convert\_Integer\_To\_Single\_Precision\_Floating\_Point(SRC[127:96])  
 DEST[MAXVL-1:128] (unmodified)

**Intel C/C++ Compiler Intrinsic Equivalent**

VCVTDQ2PS \_\_m512 \_\_mm512\_cvtepi32\_ps( \_\_m512i a);  
 VCVTDQ2PS \_\_m512 \_\_mm512\_mask\_cvtepi32\_ps( \_\_m512 s, \_\_mmask16 k, \_\_m512i a);  
 VCVTDQ2PS \_\_m512 \_\_mm512\_maskz\_cvtepi32\_ps( \_\_mmask16 k, \_\_m512i a);  
 VCVTDQ2PS \_\_m512 \_\_mm512\_cvt\_roundepsi32\_ps( \_\_m512i a, int r);  
 VCVTDQ2PS \_\_m512 \_\_mm512\_mask\_cvt\_roundepsi32\_ps( \_\_m512 s, \_\_mmask16 k, \_\_m512i a, int r);  
 VCVTDQ2PS \_\_m512 \_\_mm512\_maskz\_cvt\_roundepsi32\_ps( \_\_mmask16 k, \_\_m512i a, int r);  
 VCVTDQ2PS \_\_m256 \_\_mm256\_mask\_cvtepi32\_ps( \_\_m256 s, \_\_mmask8 k, \_\_m256i a);  
 VCVTDQ2PS \_\_m256 \_\_mm256\_maskz\_cvtepi32\_ps( \_\_mmask8 k, \_\_m256i a);  
 VCVTDQ2PS \_\_m128 \_\_mm\_mask\_cvtepi32\_ps( \_\_m128 s, \_\_mmask8 k, \_\_m128i a);  
 VCVTDQ2PS \_\_m128 \_\_mm\_maskz\_cvtepi32\_ps( \_\_mmask8 k, \_\_m128i a);  
 CVTDQ2PS \_\_m256 \_\_mm256\_cvtepi32\_ps( \_\_m256i src)  
 CVTDQ2PS \_\_m128 \_\_mm\_cvtepi32\_ps( \_\_m128i src)

**SIMD Floating-Point Exceptions**

Precision

**Other Exceptions**

VEX-encoded instructions, see Exceptions Type 2;

EVEX-encoded instructions, see Exceptions Type E2.

#UD If VEX.vvvv != 1111B or EVEX.vvvv != 1111B.

## CVTPD2DQ—Convert Packed Double-Precision Floating-Point Values to Packed Doubleword Integers

Opcode Instruction	Op / En	64/32 bit Mode Support	CPUID Feature Flag	Description
F2 0F E6 /r CVTPD2DQ xmm1, xmm2/m128	A	V/V	SSE2	Convert two packed double-precision floating-point values in xmm2/mem to two signed doubleword integers in xmm1.
VEX.128.F2.0F.WIG E6 /r VCVTPD2DQ xmm1, xmm2/m128	A	V/V	AVX	Convert two packed double-precision floating-point values in xmm2/mem to two signed doubleword integers in xmm1.
VEX.256.F2.0F.WIG E6 /r VCVTPD2DQ xmm1, ymm2/m256	A	V/V	AVX	Convert four packed double-precision floating-point values in ymm2/mem to four signed doubleword integers in xmm1.
EVEX.128.F2.0F.W1 E6 /r VCVTPD2DQ xmm1 {k1}{z}, xmm2/m128/m64bcst	B	V/V	AVX512VL AVX512F	Convert two packed double-precision floating-point values in xmm2/m128/m64bcst to two signed doubleword integers in xmm1 subject to writemask k1.
EVEX.256.F2.0F.W1 E6 /r VCVTPD2DQ xmm1 {k1}{z}, ymm2/m256/m64bcst	B	V/V	AVX512VL AVX512F	Convert four packed double-precision floating-point values in ymm2/m256/m64bcst to four signed doubleword integers in xmm1 subject to writemask k1.
EVEX.512.F2.0F.W1 E6 /r VCVTPD2DQ ymm1 {k1}{z}, zmm2/m512/m64bcst{er}	B	V/V	AVX512F	Convert eight packed double-precision floating-point values in zmm2/m512/m64bcst to eight signed doubleword integers in ymm1 subject to writemask k1.

### Instruction Operand Encoding

Op/En	Tuple Type	Operand 1	Operand 2	Operand 3	Operand 4
A	NA	ModRM:reg (w)	ModRM:r/m (r)	NA	NA
B	Full	ModRM:reg (w)	ModRM:r/m (r)	NA	NA

### Description

Converts packed double-precision floating-point values in the source operand (second operand) to packed signed doubleword integers in the destination operand (first operand).

When a conversion is inexact, the value returned is rounded according to the rounding control bits in the MXCSR register or the embedded rounding control bits. If a converted result cannot be represented in the destination format, the floating-point invalid exception is raised, and if this exception is masked, the indefinite integer value ( $2^{w-1}$ , where  $w$  represents the number of bits in the destination format) is returned.

EVEX encoded versions: The source operand is a ZMM/YMM/XMM register, a 512-bit memory location, or a 512-bit vector broadcasted from a 64-bit memory location. The destination operand is a ZMM/YMM/XMM register conditionally updated with writemask k1. The upper bits (MAXVL-1:256/128/64) of the corresponding destination are zeroed.

VEX.256 encoded version: The source operand is a YMM register or 256-bit memory location. The destination operand is an XMM register. The upper bits (MAXVL-1:128) of the corresponding ZMM register destination are zeroed.

VEX.128 encoded version: The source operand is an XMM register or 128-bit memory location. The destination operand is an XMM register. The upper bits (MAXVL-1:64) of the corresponding ZMM register destination are zeroed.

128-bit Legacy SSE version: The source operand is an XMM register or 128-bit memory location. The destination operand is an XMM register. Bits[127:64] of the destination XMM register are zeroed. However, the upper bits (MAXVL-1:128) of the corresponding ZMM register destination are unmodified.

VEX.vvvv and EVEX.vvvv are reserved and must be 1111b, otherwise instructions will #UD.

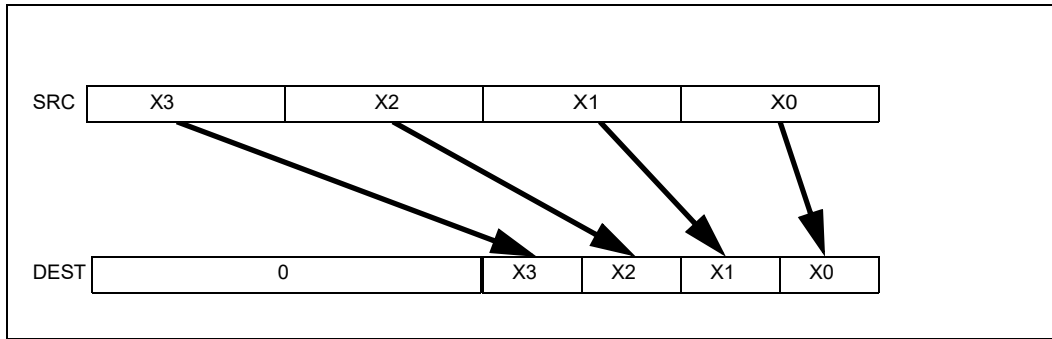

Figure 3-12. VCVTPD2DQ (VEX.256 encoded version)

### Operation

**VCVTPD2DQ (EVEX encoded versions) when src operand is a register**

(KL, VL) = (2, 128), (4, 256), (8, 512)

IF (VL = 512) AND (EVEX.b = 1)

THEN

SET\_RM(EVEX.RC);

ELSE

SET\_RM(MXCSR.RM);

FI;

FOR j ← 0 TO KL-1

i ← j \* 32

k ← j \* 64

IF k1[j] OR \*no writemask\*

THEN DEST[i+31:i] ←

Convert\_Double\_Precision\_Floating\_Point\_To\_Integer(SRC[k+63:k])

ELSE

IF \*merging-masking\* ; merging-masking

THEN \*DEST[i+31:i] remains unchanged\*

ELSE ; zeroing-masking

DEST[i+31:i] ← 0

FI

FI;

ENDFOR

DEST[MAXVL-1:VL/2] ← 0

**VCVTPD2DQ (EVEX encoded versions) when src operand is a memory source**

(KL, VL) = (2, 128), (4, 256), (8, 512)

```

FOR j ← 0 TO KL-1
  i ← j * 32
  k ← j * 64
  IF k1[j] OR *no writemask*
    THEN
      IF (EVEX.b = 1)
        THEN
          DEST[i+31:i] ←
            Convert_Double_Precision_Floating_Point_To_Integer(SRC[63:0])
        ELSE
          DEST[i+31:i] ←
            Convert_Double_Precision_Floating_Point_To_Integer(SRC[k+63:k])
      FI;
    ELSE
      IF *merging-masking*           ; merging-masking
        THEN *DEST[i+31:i] remains unchanged*
      ELSE                             ; zeroing-masking
        DEST[i+31:i] ← 0
      FI
    FI;
  FI;
ENDFOR
DEST[MAXVL-1:VL/2] ← 0

```

**VCVTPD2DQ (VEX.256 encoded version)**

```

DEST[31:0] ← Convert_Double_Precision_Floating_Point_To_Integer(SRC[63:0])
DEST[63:32] ← Convert_Double_Precision_Floating_Point_To_Integer(SRC[127:64])
DEST[95:64] ← Convert_Double_Precision_Floating_Point_To_Integer(SRC[191:128])
DEST[127:96] ← Convert_Double_Precision_Floating_Point_To_Integer(SRC[255:192])
DEST[MAXVL-1:128] ← 0

```

**VCVTPD2DQ (VEX.128 encoded version)**

```

DEST[31:0] ← Convert_Double_Precision_Floating_Point_To_Integer(SRC[63:0])
DEST[63:32] ← Convert_Double_Precision_Floating_Point_To_Integer(SRC[127:64])
DEST[MAXVL-1:64] ← 0

```

**CVTPD2DQ (128-bit Legacy SSE version)**

```

DEST[31:0] ← Convert_Double_Precision_Floating_Point_To_Integer(SRC[63:0])
DEST[63:32] ← Convert_Double_Precision_Floating_Point_To_Integer(SRC[127:64])
DEST[127:64] ← 0
DEST[MAXVL-1:128] (unmodified)

```

**Intel C/C++ Compiler Intrinsic Equivalent**

```

VCVTPD2DQ __m256i __mm512_cvtpd_epi32( __m512d a);
VCVTPD2DQ __m256i __mm512_mask_cvtpd_epi32( __m256i s, __mmask8 k, __m512d a);
VCVTPD2DQ __m256i __mm512_maskz_cvtpd_epi32( __mmask8 k, __m512d a);
VCVTPD2DQ __m256i __mm512_cvt_roundpd_epi32( __m512d a, int r);
VCVTPD2DQ __m256i __mm512_mask_cvt_roundpd_epi32( __m256i s, __mmask8 k, __m512d a, int r);
VCVTPD2DQ __m256i __mm512_maskz_cvt_roundpd_epi32( __mmask8 k, __m512d a, int r);
VCVTPD2DQ __m128i __mm256_mask_cvtpd_epi32( __m128i s, __mmask8 k, __m256d a);
VCVTPD2DQ __m128i __mm256_maskz_cvtpd_epi32( __mmask8 k, __m256d a);
VCVTPD2DQ __m128i __mm_mask_cvtpd_epi32( __m128i s, __mmask8 k, __m128d a);
VCVTPD2DQ __m128i __mm_maskz_cvtpd_epi32( __mmask8 k, __m128d a);
VCVTPD2DQ __m128i __mm256_cvtpd_epi32( __m256d src)
CVTPD2DQ __m128i __mm_cvtpd_epi32( __m128d src)

```

**SIMD Floating-Point Exceptions**

Invalid, Precision

**Other Exceptions**

See Exceptions Type 2; additionally

EVEX-encoded instructions, see Exceptions Type E2.

#UD If VEX.vvvv != 1111B or EVEX.vvvv != 1111B.

## CVTPD2PI—Convert Packed Double-Precision FP Values to Packed Dword Integers

Opcode/ Instruction	Op/ En	64-Bit Mode	Compat/ Leg Mode	Description
66 OF 2D /r CVTPD2PI <i>mm, xmm/m128</i>	RM	Valid	Valid	Convert two packed double-precision floating-point values from <i>xmm/m128</i> to two packed signed doubleword integers in <i>mm</i> .

### Instruction Operand Encoding

Op/En	Operand 1	Operand 2	Operand 3	Operand 4
RM	ModRM:reg ( <i>w</i> )	ModRM:r/m ( <i>r</i> )	NA	NA

### Description

Converts two packed double-precision floating-point values in the source operand (second operand) to two packed signed doubleword integers in the destination operand (first operand).

The source operand can be an XMM register or a 128-bit memory location. The destination operand is an MMX technology register.

When a conversion is inexact, the value returned is rounded according to the rounding control bits in the MXCSR register. If a converted result is larger than the maximum signed doubleword integer, the floating-point invalid exception is raised, and if this exception is masked, the indefinite integer value (80000000H) is returned.

This instruction causes a transition from x87 FPU to MMX technology operation (that is, the x87 FPU top-of-stack pointer is set to 0 and the x87 FPU tag word is set to all 0s [valid]). If this instruction is executed while an x87 FPU floating-point exception is pending, the exception is handled before the CVTPD2PI instruction is executed.

In 64-bit mode, use of the REX.R prefix permits this instruction to access additional registers (XMM8-XMM15).

### Operation

```
DEST[31:0] ← Convert_Double_Precision_Floating_Point_To_Integer32(SRC[63:0]);
DEST[63:32] ← Convert_Double_Precision_Floating_Point_To_Integer32(SRC[127:64]);
```

### Intel C/C++ Compiler Intrinsic Equivalent

```
CVTPD1PI:   __m64 _mm_cvtpd_pi32(__m128d a)
```

### SIMD Floating-Point Exceptions

Invalid, Precision.

### Other Exceptions

See Table 22-4, "Exception Conditions for Legacy SIMD/MMX Instructions with FP Exception and 16-Byte Alignment," in the *Intel® 64 and IA-32 Architectures Software Developer's Manual, Volume 3B*.



## CVTPD2PS—Convert Packed Double-Precision Floating-Point Values to Packed Single-Precision Floating-Point Values

Opcode/ Instruction	Op/ En	64/32 bit Mode Support	CPUID Feature Flag	Description
66 0F 5A /r CVTPD2PS xmm1, xmm2/m128	A	V/V	SSE2	Convert two packed double-precision floating-point values in xmm2/mem to two single-precision floating-point values in xmm1.
VEX.128.66.0F.WIG 5A /r VCVTPD2PS xmm1, xmm2/m128	A	V/V	AVX	Convert two packed double-precision floating-point values in xmm2/mem to two single-precision floating-point values in xmm1.
VEX.256.66.0F.WIG 5A /r VCVTPD2PS xmm1, ymm2/m256	A	V/V	AVX	Convert four packed double-precision floating-point values in ymm2/mem to four single-precision floating-point values in xmm1.
EVEX.128.66.0F.W1 5A /r VCVTPD2PS xmm1 {k1}{z}, xmm2/m128/m64bcst	B	V/V	AVX512VL AVX512F	Convert two packed double-precision floating-point values in xmm2/m128/m64bcst to two single-precision floating-point values in xmm1 with writemask k1.
EVEX.256.66.0F.W1 5A /r VCVTPD2PS xmm1 {k1}{z}, ymm2/m256/m64bcst	B	V/V	AVX512VL AVX512F	Convert four packed double-precision floating-point values in ymm2/m256/m64bcst to four single-precision floating-point values in xmm1 with writemask k1.
EVEX.512.66.0F.W1 5A /r VCVTPD2PS ymm1 {k1}{z}, zmm2/m512/m64bcst{er}	B	V/V	AVX512F	Convert eight packed double-precision floating-point values in zmm2/m512/m64bcst to eight single-precision floating-point values in ymm1 with writemask k1.

### Instruction Operand Encoding

Op/En	Tuple Type	Operand 1	Operand 2	Operand 3	Operand 4
A	NA	ModRM:reg (w)	ModRM:r/m (r)	NA	NA
B	Full	ModRM:reg (w)	ModRM:r/m (r)	NA	NA

### Description

Converts two, four or eight packed double-precision floating-point values in the source operand (second operand) to two, four or eight packed single-precision floating-point values in the destination operand (first operand).

When a conversion is inexact, the value returned is rounded according to the rounding control bits in the MXCSR register or the embedded rounding control bits.

EVEX encoded versions: The source operand is a ZMM/YMM/XMM register, a 512/256/128-bit memory location, or a 512/256/128-bit vector broadcasted from a 64-bit memory location. The destination operand is a YMM/XMM/XMM (low 64-bits) register conditionally updated with writemask k1. The upper bits (MAXVL-1:256/128/64) of the corresponding destination are zeroed.

VEX.256 encoded version: The source operand is a YMM register or 256-bit memory location. The destination operand is an XMM register. The upper bits (MAXVL-1:128) of the corresponding ZMM register destination are zeroed.

VEX.128 encoded version: The source operand is an XMM register or 128-bit memory location. The destination operand is a YMM register. The upper bits (MAXVL-1:64) of the corresponding ZMM register destination are zeroed.

128-bit Legacy SSE version: The source operand is an XMM register or 128-bit memory location. The destination operand is an XMM register. Bits[127:64] of the destination XMM register are zeroed. However, the upper Bits (MAXVL-1:128) of the corresponding ZMM register destination are unmodified.

VEX.vvvv and EVEX.vvvv are reserved and must be 1111b otherwise instructions will #UD.

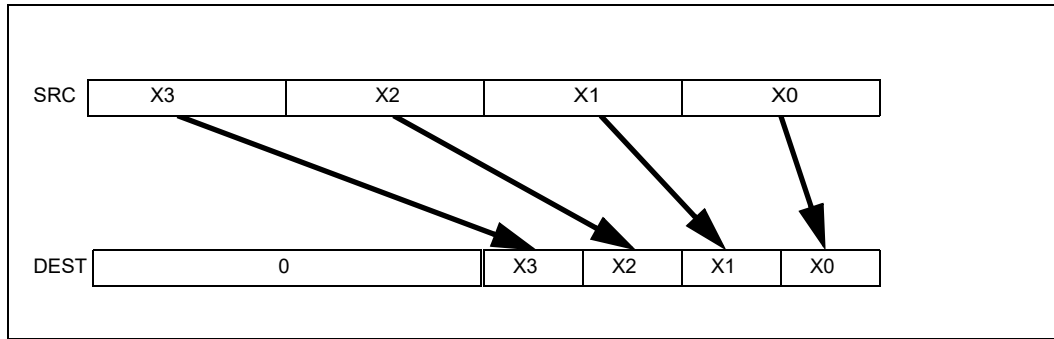

Figure 3-13. VCVTPD2PS (VEX.256 encoded version)

**Operation****VCVTPD2PS (EVEX encoded version) when src operand is a register** $(KL, VL) = (2, 128), (4, 256), (8, 512)$ IF  $(VL = 512)$  AND  $(EVEX.b = 1)$ 

THEN

SET\_RM(EVEX.RC);

ELSE

SET\_RM(MXCSR.RM);

FI;

FOR  $j \leftarrow 0$  TO  $KL-1$  $i \leftarrow j * 32$  $k \leftarrow j * 64$ IF  $k1[j]$  OR \*no writemask\*

THEN

 $DEST[i+31:i] \leftarrow \text{Convert\_Double\_Precision\_Floating\_Point\_To\_Single\_Precision\_Floating\_Point}(SRC[k+63:k])$ 

ELSE

IF \*merging-masking\* ; merging-masking

THEN \*DEST[i+31:i] remains unchanged\*

ELSE ; zeroing-masking

 $DEST[i+31:i] \leftarrow 0$ 

FI

FI;

ENDFOR

 $DEST[MAXVL-1:VL/2] \leftarrow 0$

**VCVTPD2PS (EVEX encoded version) when src operand is a memory source**

(KL, VL) = (2, 128), (4, 256), (8, 512)

```

FOR j ← 0 TO KL-1
  i ← j * 32
  k ← j * 64
  IF k1[j] OR *no writemask*
    THEN
      IF (EVEX.b = 1)
        THEN
          DEST[i+31:i] ← Convert_Double_Precision_Floating_Point_To_Single_Precision_Floating_Point(SRC[63:0])
        ELSE
          DEST[i+31:i] ← Convert_Double_Precision_Floating_Point_To_Single_Precision_Floating_Point(SRC[k+63:k])
        FI;
      ELSE
        IF *merging-masking*           ; merging-masking
          THEN *DEST[i+31:i] remains unchanged*
        ELSE                             ; zeroing-masking
          DEST[i+31:i] ← 0
        FI
      FI;
    ENDFOR
  DEST[MAXVL-1:VL/2] ← 0

```

**VCVTPD2PS (VEX.256 encoded version)**

```

DEST[31:0] ← Convert_Double_Precision_To_Single_Precision_Floating_Point(SRC[63:0])
DEST[63:32] ← Convert_Double_Precision_To_Single_Precision_Floating_Point(SRC[127:64])
DEST[95:64] ← Convert_Double_Precision_To_Single_Precision_Floating_Point(SRC[191:128])
DEST[127:96] ← Convert_Double_Precision_To_Single_Precision_Floating_Point(SRC[255:192])
DEST[MAXVL-1:128] ← 0

```

**VCVTPD2PS (VEX.128 encoded version)**

```

DEST[31:0] ← Convert_Double_Precision_To_Single_Precision_Floating_Point(SRC[63:0])
DEST[63:32] ← Convert_Double_Precision_To_Single_Precision_Floating_Point(SRC[127:64])
DEST[MAXVL-1:64] ← 0

```

**CVTPD2PS (128-bit Legacy SSE version)**

```

DEST[31:0] ← Convert_Double_Precision_To_Single_Precision_Floating_Point(SRC[63:0])
DEST[63:32] ← Convert_Double_Precision_To_Single_Precision_Floating_Point(SRC[127:64])
DEST[127:64] ← 0
DEST[MAXVL-1:128] (unmodified)

```

**Intel C/C++ Compiler Intrinsic Equivalent**

```

VCVTPD2PS __m256 __mm512_cvtpd_ps( __m512d a);
VCVTPD2PS __m256 __mm512_mask_cvtpd_ps( __m256 s, __mmask8 k, __m512d a);
VCVTPD2PS __m256 __mm512_maskz_cvtpd_ps( __mmask8 k, __m512d a);
VCVTPD2PS __m256 __mm512_cvt_roundpd_ps( __m512d a, int r);
VCVTPD2PS __m256 __mm512_mask_cvt_roundpd_ps( __m256 s, __mmask8 k, __m512d a, int r);
VCVTPD2PS __m256 __mm512_maskz_cvt_roundpd_ps( __mmask8 k, __m512d a, int r);
VCVTPD2PS __m128 __mm256_mask_cvtpd_ps( __m128 s, __mmask8 k, __m256d a);
VCVTPD2PS __m128 __mm256_maskz_cvtpd_ps( __mmask8 k, __m256d a);
VCVTPD2PS __m128 __mm_mask_cvtpd_ps( __m128 s, __mmask8 k, __m128d a);
VCVTPD2PS __m128 __mm_maskz_cvtpd_ps( __mmask8 k, __m128d a);
VCVTPD2PS __m128 __mm256_cvtpd_ps( __m256d a)
CVTPD2PS __m128 __mm_cvtpd_ps( __m128d a)

```

**SIMD Floating-Point Exceptions**

Invalid, Precision, Underflow, Overflow, Denormal

**Other Exceptions**

VEX-encoded instructions, see Exceptions Type 2;

EVEX-encoded instructions, see Exceptions Type E2.

#UD                    If VEX.vvvv != 1111B or EVEX.vvvv != 1111B.

## CVTPI2PD—Convert Packed Dword Integers to Packed Double-Precision FP Values

Opcode/ Instruction	Op/ En	64-Bit Mode	Compat/ Leg Mode	Description
66 0F 2A /r CVTPI2PD <i>xmm, mm/m64*</i>	RM	Valid	Valid	Convert two packed signed doubleword integers from <i>mm/mem64</i> to two packed double-precision floating-point values in <i>xmm</i> .

### NOTES:

\*Operation is different for different operand sets; see the Description section.

### Instruction Operand Encoding

Op/En	Operand 1	Operand 2	Operand 3	Operand 4
RM	ModRM:reg (w)	ModRM:r/m (r)	NA	NA

### Description

Converts two packed signed doubleword integers in the source operand (second operand) to two packed double-precision floating-point values in the destination operand (first operand).

The source operand can be an MMX technology register or a 64-bit memory location. The destination operand is an XMM register. In addition, depending on the operand configuration:

- For operands *xmm, mm*: the instruction causes a transition from x87 FPU to MMX technology operation (that is, the x87 FPU top-of-stack pointer is set to 0 and the x87 FPU tag word is set to all 0s [valid]). If this instruction is executed while an x87 FPU floating-point exception is pending, the exception is handled before the CVTPI2PD instruction is executed.
- For operands *xmm, m64*: the instruction does not cause a transition to MMX technology and does not take x87 FPU exceptions.

In 64-bit mode, use of the REX.R prefix permits this instruction to access additional registers (XMM8-XMM15).

### Operation

```
DEST[63:0] ← Convert_Integer_To_Double_Precision_Floating_Point(SRC[31:0]);
DEST[127:64] ← Convert_Integer_To_Double_Precision_Floating_Point(SRC[63:32]);
```

### Intel C/C++ Compiler Intrinsic Equivalent

```
CVTPI2PD:  __m128d _mm_cvtpi32_pd(__m64 a)
```

### SIMD Floating-Point Exceptions

None

### Other Exceptions

See Table 22-6, “Exception Conditions for Legacy SIMD/MMX Instructions with XMM and without FP Exception,” in the *Intel® 64 and IA-32 Architectures Software Developer’s Manual, Volume 3B*.

## CVTPI2PS—Convert Packed Dword Integers to Packed Single-Precision FP Values

Opcode/ Instruction	Op/ En	64-Bit Mode	Compat/ Leg Mode	Description
NP OF 2A /r CVTPI2PS <i>xmm, mm/m64</i>	RM	Valid	Valid	Convert two signed doubleword integers from <i>mm/m64</i> to two single-precision floating-point values in <i>xmm</i> .

### Instruction Operand Encoding

Op/En	Operand 1	Operand 2	Operand 3	Operand 4
RM	ModRM:reg (w)	ModRM:r/m (r)	NA	NA

### Description

Converts two packed signed doubleword integers in the source operand (second operand) to two packed single-precision floating-point values in the destination operand (first operand).

The source operand can be an MMX technology register or a 64-bit memory location. The destination operand is an XMM register. The results are stored in the low quadword of the destination operand, and the high quadword remains unchanged. When a conversion is inexact, the value returned is rounded according to the rounding control bits in the MXCSR register.

This instruction causes a transition from x87 FPU to MMX technology operation (that is, the x87 FPU top-of-stack pointer is set to 0 and the x87 FPU tag word is set to all 0s [valid]). If this instruction is executed while an x87 FPU floating-point exception is pending, the exception is handled before the CVTPI2PS instruction is executed.

In 64-bit mode, use of the REX.R prefix permits this instruction to access additional registers (XMM8-XMM15).

### Operation

```
DEST[31:0] ← Convert_Integer_To_Single_Precision_Floating_Point(SRC[31:0]);
DEST[63:32] ← Convert_Integer_To_Single_Precision_Floating_Point(SRC[63:32]);
(* High quadword of destination unchanged *)
```

### Intel C/C++ Compiler Intrinsic Equivalent

```
CVTPI2PS:  __m128 _mm_cvtpi32_ps(__m128 a, __m64 b)
```

### SIMD Floating-Point Exceptions

Precision

### Other Exceptions

See Table 22-5, “Exception Conditions for Legacy SIMD/MMX Instructions with XMM and FP Exception,” in the *Intel® 64 and IA-32 Architectures Software Developer’s Manual, Volume 3B*.

## CVTPS2DQ—Convert Packed Single-Precision Floating-Point Values to Packed Signed Doubleword Integer Values

Opcode/ Instruction	Op / En	64/32 bit Mode Support	CPUID Feature Flag	Description
66 0F 5B /r CVTPS2DQ xmm1, xmm2/m128	A	V/V	SSE2	Convert four packed single-precision floating-point values from xmm2/mem to four packed signed doubleword values in xmm1.
VEX.128.66.0F.WIG 5B /r VCVTPS2DQ xmm1, xmm2/m128	A	V/V	AVX	Convert four packed single-precision floating-point values from xmm2/mem to four packed signed doubleword values in xmm1.
VEX.256.66.0F.WIG 5B /r VCVTPS2DQ ymm1, ymm2/m256	A	V/V	AVX	Convert eight packed single-precision floating-point values from ymm2/mem to eight packed signed doubleword values in ymm1.
EVEX.128.66.0F.W0 5B /r VCVTPS2DQ xmm1 {k1}{z}, xmm2/m128/m32bcst	B	V/V	AVX512VL AVX512F	Convert four packed single precision floating-point values from xmm2/m128/m32bcst to four packed signed doubleword values in xmm1 subject to writemask k1.
EVEX.256.66.0F.W0 5B /r VCVTPS2DQ ymm1 {k1}{z}, ymm2/m256/m32bcst	B	V/V	AVX512VL AVX512F	Convert eight packed single precision floating-point values from ymm2/m256/m32bcst to eight packed signed doubleword values in ymm1 subject to writemask k1.
EVEX.512.66.0F.W0 5B /r VCVTPS2DQ zmm1 {k1}{z}, zmm2/m512/m32bcst{er}	B	V/V	AVX512F	Convert sixteen packed single-precision floating-point values from zmm2/m512/m32bcst to sixteen packed signed doubleword values in zmm1 subject to writemask k1.

### Instruction Operand Encoding

Op/En	Tuple Type	Operand 1	Operand 2	Operand 3	Operand 4
A	NA	ModRM:reg (w)	ModRM:r/m (r)	NA	NA
B	Full	ModRM:reg (w)	ModRM:r/m (r)	NA	NA

### Description

Converts four, eight or sixteen packed single-precision floating-point values in the source operand to four, eight or sixteen signed doubleword integers in the destination operand.

When a conversion is inexact, the value returned is rounded according to the rounding control bits in the MXCSR register or the embedded rounding control bits. If a converted result cannot be represented in the destination format, the floating-point invalid exception is raised, and if this exception is masked, the indefinite integer value ( $2^{w-1}$ , where  $w$  represents the number of bits in the destination format) is returned.

EVEX encoded versions: The source operand is a ZMM register, a 512-bit memory location or a 512-bit vector broadcasted from a 32-bit memory location. The destination operand is a ZMM register conditionally updated with writemask k1.

VEX.256 encoded version: The source operand is a YMM register or 256-bit memory location. The destination operand is a YMM register. The upper bits (MAXVL-1:256) of the corresponding ZMM register destination are zeroed.

VEX.128 encoded version: The source operand is an XMM register or 128-bit memory location. The destination operand is an XMM register. The upper bits (MAXVL-1:128) of the corresponding ZMM register destination are zeroed.

128-bit Legacy SSE version: The source operand is an XMM register or 128-bit memory location. The destination operand is an XMM register. The upper bits (MAXVL-1:128) of the corresponding ZMM register destination are unmodified.

VEX.vvvv and EVEX.vvvv are reserved and must be 1111b otherwise instructions will #UD.

**Operation****VCVTPS2DQ (encoded versions) when src operand is a register**

(KL, VL) = (4, 128), (8, 256), (16, 512)

IF (VL = 512) AND (EVEX.b = 1)

THEN

SET\_RM(EVEX.RC);

ELSE

SET\_RM(MXCSR.RM);

FI;

FOR j ← 0 TO KL-1

i ← j \* 32

IF k1[j] OR \*no writemask\*

THEN DEST[i+31:i] ←

Convert\_Single\_Precision\_Floating\_Point\_To\_Integer(SRC[i+31:i])

ELSE

IF \*merging-masking\* ; merging-masking

THEN \*DEST[i+31:i] remains unchanged\*

ELSE ; zeroing-masking

DEST[i+31:i] ← 0

FI

FI;

ENDFOR

DEST[MAXVL-1:VL] ← 0

**VCVTPS2DQ (EVEX encoded versions) when src operand is a memory source**

(KL, VL) = (4, 128), (8, 256), (16, 512)

FOR j ← 0 TO 15

i ← j \* 32

IF k1[j] OR \*no writemask\*

THEN

IF (EVEX.b = 1)

THEN

DEST[i+31:i] ←

Convert\_Single\_Precision\_Floating\_Point\_To\_Integer(SRC[31:0])

ELSE

DEST[i+31:i] ←

Convert\_Single\_Precision\_Floating\_Point\_To\_Integer(SRC[i+31:i])

FI;

ELSE

IF \*merging-masking\* ; merging-masking

THEN \*DEST[i+31:i] remains unchanged\*

ELSE ; zeroing-masking

DEST[i+31:i] ← 0

FI

FI;

ENDFOR

DEST[MAXVL-1:VL] ← 0



**VCVTPS2DQ (VEX.256 encoded version)**

DEST[31:0] ← Convert\_Single\_Precision\_Floating\_Point\_To\_Integer(SRC[31:0])  
 DEST[63:32] ← Convert\_Single\_Precision\_Floating\_Point\_To\_Integer(SRC[63:32])  
 DEST[95:64] ← Convert\_Single\_Precision\_Floating\_Point\_To\_Integer(SRC[95:64])  
 DEST[127:96] ← Convert\_Single\_Precision\_Floating\_Point\_To\_Integer(SRC[127:96])  
 DEST[159:128] ← Convert\_Single\_Precision\_Floating\_Point\_To\_Integer(SRC[159:128])  
 DEST[191:160] ← Convert\_Single\_Precision\_Floating\_Point\_To\_Integer(SRC[191:160])  
 DEST[223:192] ← Convert\_Single\_Precision\_Floating\_Point\_To\_Integer(SRC[223:192])  
 DEST[255:224] ← Convert\_Single\_Precision\_Floating\_Point\_To\_Integer(SRC[255:224])

**VCVTPS2DQ (VEX.128 encoded version)**

DEST[31:0] ← Convert\_Single\_Precision\_Floating\_Point\_To\_Integer(SRC[31:0])  
 DEST[63:32] ← Convert\_Single\_Precision\_Floating\_Point\_To\_Integer(SRC[63:32])  
 DEST[95:64] ← Convert\_Single\_Precision\_Floating\_Point\_To\_Integer(SRC[95:64])  
 DEST[127:96] ← Convert\_Single\_Precision\_Floating\_Point\_To\_Integer(SRC[127:96])  
 DEST[MAXVL-1:128] ← 0

**CVTPS2DQ (128-bit Legacy SSE version)**

DEST[31:0] ← Convert\_Single\_Precision\_Floating\_Point\_To\_Integer(SRC[31:0])  
 DEST[63:32] ← Convert\_Single\_Precision\_Floating\_Point\_To\_Integer(SRC[63:32])  
 DEST[95:64] ← Convert\_Single\_Precision\_Floating\_Point\_To\_Integer(SRC[95:64])  
 DEST[127:96] ← Convert\_Single\_Precision\_Floating\_Point\_To\_Integer(SRC[127:96])  
 DEST[MAXVL-1:128] (unmodified)

**Intel C/C++ Compiler Intrinsic Equivalent**

VCVTPS2DQ \_\_m512i \_\_mm512\_cvtps\_epi32( \_\_m512 a);  
 VCVTPS2DQ \_\_m512i \_\_mm512\_mask\_cvtps\_epi32( \_\_m512i s, \_\_mmask16 k, \_\_m512 a);  
 VCVTPS2DQ \_\_m512i \_\_mm512\_maskz\_cvtps\_epi32( \_\_mmask16 k, \_\_m512 a);  
 VCVTPS2DQ \_\_m512i \_\_mm512\_cvt\_roundps\_epi32( \_\_m512 a, int r);  
 VCVTPS2DQ \_\_m512i \_\_mm512\_mask\_cvt\_roundps\_epi32( \_\_m512i s, \_\_mmask16 k, \_\_m512 a, int r);  
 VCVTPS2DQ \_\_m512i \_\_mm512\_maskz\_cvt\_roundps\_epi32( \_\_mmask16 k, \_\_m512 a, int r);  
 VCVTPS2DQ \_\_m256i \_\_mm256\_mask\_cvtps\_epi32( \_\_m256i s, \_\_mmask8 k, \_\_m256 a);  
 VCVTPS2DQ \_\_m256i \_\_mm256\_maskz\_cvtps\_epi32( \_\_mmask8 k, \_\_m256 a);  
 VCVTPS2DQ \_\_m128i \_\_mm\_mask\_cvtps\_epi32( \_\_m128i s, \_\_mmask8 k, \_\_m128 a);  
 VCVTPS2DQ \_\_m128i \_\_mm\_maskz\_cvtps\_epi32( \_\_mmask8 k, \_\_m128 a);  
 VCVTPS2DQ \_\_m256i \_\_mm256\_cvtps\_epi32( \_\_m256 a)  
 CVTPS2DQ \_\_m128i \_\_mm\_cvtps\_epi32( \_\_m128 a)

**SIMD Floating-Point Exceptions**

Invalid, Precision

**Other Exceptions**

VEX-encoded instructions, see Exceptions Type 2;

EVEX-encoded instructions, see Exceptions Type E2.

#UD If VEX.vvvv != 1111B or EVEX.vvvv != 1111B.

## CVTTPS2PD—Convert Packed Single-Precision Floating-Point Values to Packed Double-Precision Floating-Point Values

Opcode/ Instruction	Op/ En	64/32 bit Mode Support	CPUID Feature Flag	Description
NP OF 5A /r CVTTPS2PD xmm1, xmm2/m64	A	V/V	SSE2	Convert two packed single-precision floating-point values in xmm2/m64 to two packed double-precision floating-point values in xmm1.
VEX.128.OF.WIG 5A /r VCVTTPS2PD xmm1, xmm2/m64	A	V/V	AVX	Convert two packed single-precision floating-point values in xmm2/m64 to two packed double-precision floating-point values in xmm1.
VEX.256.OF.WIG 5A /r VCVTTPS2PD ymm1, xmm2/m128	A	V/V	AVX	Convert four packed single-precision floating-point values in xmm2/m128 to four packed double-precision floating-point values in ymm1.
EVEX.128.OF.W0 5A /r VCVTTPS2PD xmm1 {k1}{z}, xmm2/m64/m32bcst	B	V/V	AVX512VL AVX512F	Convert two packed single-precision floating-point values in xmm2/m64/m32bcst to packed double-precision floating-point values in xmm1 with writemask k1.
EVEX.256.OF.W0 5A /r VCVTTPS2PD ymm1 {k1}{z}, xmm2/m128/m32bcst	B	V/V	AVX512VL	Convert four packed single-precision floating-point values in xmm2/m128/m32bcst to packed double-precision floating-point values in ymm1 with writemask k1.
EVEX.512.OF.W0 5A /r VCVTTPS2PD zmm1 {k1}{z}, ymm2/m256/m32bcst{sae}	B	V/V	AVX512F	Convert eight packed single-precision floating-point values in ymm2/m256/b32bcst to eight packed double-precision floating-point values in zmm1 with writemask k1.

### Instruction Operand Encoding

Op/En	Tuple Type	Operand 1	Operand 2	Operand 3	Operand 4
A	NA	ModRM:reg (w)	ModRM:r/m (r)	NA	NA
B	Half	ModRM:reg (w)	ModRM:r/m (r)	NA	NA

### Description

Converts two, four or eight packed single-precision floating-point values in the source operand (second operand) to two, four or eight packed double-precision floating-point values in the destination operand (first operand).

EVEX encoded versions: The source operand is a YMM/XMM/XMM (low 64-bits) register, a 256/128/64-bit memory location or a 256/128/64-bit vector broadcasted from a 32-bit memory location. The destination operand is a ZMM/YMM/XMM register conditionally updated with writemask k1.

VEX.256 encoded version: The source operand is an XMM register or 128-bit memory location. The destination operand is a YMM register. Bits (MAXVL-1:256) of the corresponding destination ZMM register are zeroed.

VEX.128 encoded version: The source operand is an XMM register or 64-bit memory location. The destination operand is an XMM register. The upper Bits (MAXVL-1:128) of the corresponding ZMM register destination are zeroed.

128-bit Legacy SSE version: The source operand is an XMM register or 64-bit memory location. The destination operand is an XMM register. The upper Bits (MAXVL-1:128) of the corresponding ZMM register destination are unmodified.

Note: VEX.vvvv and EVEX.vvvv are reserved and must be 1111b otherwise instructions will #UD.

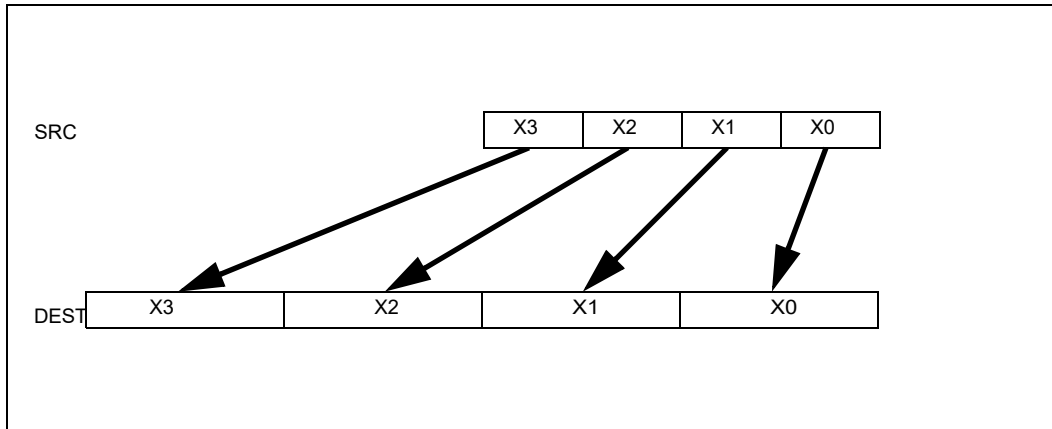

Figure 3-14. CVTSP2PD (VEX.256 encoded version)

### Operation

#### VCVTSP2PD (EVEX encoded versions) when src operand is a register

(KL, VL) = (2, 128), (4, 256), (8, 512)

FOR j ← 0 TO KL-1

  i ← j \* 64

  k ← j \* 32

  IF k1[j] OR \*no writemask\*

    THEN DEST[i+63:i] ←

      Convert\_Single\_Precision\_To\_Double\_Precision\_Floating\_Point(SRC[k+31:k])

  ELSE

    IF \*merging-masking\* ; merging-masking

      THEN \*DEST[i+63:i] remains unchanged\*

    ELSE ; zeroing-masking

      DEST[i+63:i] ← 0

  FI

FI;

ENDFOR

DEST[MAXVL-1:VL] ← 0

#### VCVTSP2PD (EVEX encoded versions) when src operand is a memory source

(KL, VL) = (2, 128), (4, 256), (8, 512)

FOR j ← 0 TO KL-1

  i ← j \* 64

  k ← j \* 32

  IF k1[j] OR \*no writemask\*

    THEN

      IF (EVEX.b = 1)

        THEN

          DEST[i+63:i] ←

          Convert\_Single\_Precision\_To\_Double\_Precision\_Floating\_Point(SRC[31:0])

        ELSE

          DEST[i+63:i] ←

          Convert\_Single\_Precision\_To\_Double\_Precision\_Floating\_Point(SRC[k+31:k])

      FI;

    ELSE

```

        IF *merging-masking*           ; merging-masking
            THEN *DEST[j+63:i] remains unchanged*
            ELSE                         ; zeroing-masking
                DEST[j+63:i] ← 0
        FI
    FI;
ENDFOR
DEST[MAXVL-1:VL] ← 0

```

**VCVTPS2PD (VEX.256 encoded version)**

```

DEST[63:0] ← Convert_Single_Precision_To_Double_Precision_Floating_Point(SRC[31:0])
DEST[127:64] ← Convert_Single_Precision_To_Double_Precision_Floating_Point(SRC[63:32])
DEST[191:128] ← Convert_Single_Precision_To_Double_Precision_Floating_Point(SRC[95:64])
DEST[255:192] ← Convert_Single_Precision_To_Double_Precision_Floating_Point(SRC[127:96])
DEST[MAXVL-1:256] ← 0

```

**VCVTPS2PD (VEX.128 encoded version)**

```

DEST[63:0] ← Convert_Single_Precision_To_Double_Precision_Floating_Point(SRC[31:0])
DEST[127:64] ← Convert_Single_Precision_To_Double_Precision_Floating_Point(SRC[63:32])
DEST[MAXVL-1:128] ← 0

```

**CVTTPS2PD (128-bit Legacy SSE version)**

```

DEST[63:0] ← Convert_Single_Precision_To_Double_Precision_Floating_Point(SRC[31:0])
DEST[127:64] ← Convert_Single_Precision_To_Double_Precision_Floating_Point(SRC[63:32])
DEST[MAXVL-1:128] (unmodified)

```

**Intel C/C++ Compiler Intrinsic Equivalent**

```

VCVTPS2PD __m512d __mm512_cvtps_pd( __m256 a);
VCVTPS2PD __m512d __mm512_mask_cvtps_pd( __m512d s, __mmask8 k, __m256 a);
VCVTPS2PD __m512d __mm512_maskz_cvtps_pd( __mmask8 k, __m256 a);
VCVTPS2PD __m512d __mm512_cvt_roundps_pd( __m256 a, int sae);
VCVTPS2PD __m512d __mm512_mask_cvt_roundps_pd( __m512d s, __mmask8 k, __m256 a, int sae);
VCVTPS2PD __m512d __mm512_maskz_cvt_roundps_pd( __mmask8 k, __m256 a, int sae);
VCVTPS2PD __m256d __mm256_mask_cvtps_pd( __m256d s, __mmask8 k, __m128 a);
VCVTPS2PD __m256d __mm256_maskz_cvtps_pd( __mmask8 k, __m128a);
VCVTPS2PD __m128d __mm_mask_cvtps_pd( __m128d s, __mmask8 k, __m128 a);
VCVTPS2PD __m128d __mm_maskz_cvtps_pd( __mmask8 k, __m128 a);
VCVTPS2PD __m256d __mm256_cvtps_pd( __m128 a)
CVTTPS2PD __m128d __mm_cvtps_pd( __m128 a)

```

**SIMD Floating-Point Exceptions**

Invalid, Denormal

**Other Exceptions**

VEX-encoded instructions, see Exceptions Type 3;

EVEX-encoded instructions, see Exceptions Type E3.

#UD If VEX.vvvv != 1111B or EVEX.vvvv != 1111B.

## CVTPS2PI—Convert Packed Single-Precision FP Values to Packed Dword Integers

Opcode/ Instruction	Op/ En	64-Bit Mode	Compat/ Leg Mode	Description
NP OF 2D /r CVTPS2PI <i>mm, xmm/m64</i>	RM	Valid	Valid	Convert two packed single-precision floating-point values from <i>xmm/m64</i> to two packed signed doubleword integers in <i>mm</i> .

### Instruction Operand Encoding

Op/En	Operand 1	Operand 2	Operand 3	Operand 4
RM	ModRM:reg (w)	ModRM:r/m (r)	NA	NA

### Description

Converts two packed single-precision floating-point values in the source operand (second operand) to two packed signed doubleword integers in the destination operand (first operand).

The source operand can be an XMM register or a 128-bit memory location. The destination operand is an MMX technology register. When the source operand is an XMM register, the two single-precision floating-point values are contained in the low quadword of the register. When a conversion is inexact, the value returned is rounded according to the rounding control bits in the MXCSR register. If a converted result is larger than the maximum signed doubleword integer, the floating-point invalid exception is raised, and if this exception is masked, the indefinite integer value (80000000H) is returned.

CVTPS2PI causes a transition from x87 FPU to MMX technology operation (that is, the x87 FPU top-of-stack pointer is set to 0 and the x87 FPU tag word is set to all 0s [valid]). If this instruction is executed while an x87 FPU floating-point exception is pending, the exception is handled before the CVTPS2PI instruction is executed.

In 64-bit mode, use of the REX.R prefix permits this instruction to access additional registers (XMM8-XMM15).

### Operation

```
DEST[31:0] ← Convert_Single_Precision_Floating_Point_To_Integer(SRC[31:0]);
DEST[63:32] ← Convert_Single_Precision_Floating_Point_To_Integer(SRC[63:32]);
```

### Intel C/C++ Compiler Intrinsic Equivalent

```
CVTPS2PI:  __m64 _mm_cvtps_pi32(__m128 a)
```

### SIMD Floating-Point Exceptions

Invalid, Precision

### Other Exceptions

See Table 22-5, “Exception Conditions for Legacy SIMD/MMX Instructions with XMM and FP Exception,” in the *Intel® 64 and IA-32 Architectures Software Developer’s Manual, Volume 3B*.

## CVTSD2SI—Convert Scalar Double-Precision Floating-Point Value to Doubleword Integer

Opcode/ Instruction	Op/ En	64/32 bit Mode Support	CPUID Feature Flag	Description
F2 OF 2D /r CVTSD2SI r32, xmm1/m64	A	V/V	SSE2	Convert one double-precision floating-point value from xmm1/m64 to one signed doubleword integer r32.
F2 REX.W OF 2D /r CVTSD2SI r64, xmm1/m64	A	V/N.E.	SSE2	Convert one double-precision floating-point value from xmm1/m64 to one signed quadword integer sign-extended into r64.
VEX.LIG.F2.OF.W0 2D /r <sup>1</sup> VCVTSD2SI r32, xmm1/m64	A	V/V	AVX	Convert one double-precision floating-point value from xmm1/m64 to one signed doubleword integer r32.
VEX.LIG.F2.OF.W1 2D /r <sup>1</sup> VCVTSD2SI r64, xmm1/m64	A	V/N.E. <sup>2</sup>	AVX	Convert one double-precision floating-point value from xmm1/m64 to one signed quadword integer sign-extended into r64.
EVEX.LIG.F2.OF.W0 2D /r VCVTSD2SI r32, xmm1/m64{er}	B	V/V	AVX512F	Convert one double-precision floating-point value from xmm1/m64 to one signed doubleword integer r32.
EVEX.LIG.F2.OF.W1 2D /r VCVTSD2SI r64, xmm1/m64{er}	B	V/N.E. <sup>2</sup>	AVX512F	Convert one double-precision floating-point value from xmm1/m64 to one signed quadword integer sign-extended into r64.

### NOTES:

- Software should ensure VCVTSD2SI is encoded with VEX.L=0. Encoding VCVTSD2SI with VEX.L=1 may encounter unpredictable behavior across different processor generations.
- VEX.W1/EVEX.W1 in non-64 bit is ignored; the instructions behaves as if the W0 version is used.

### Instruction Operand Encoding

Op/En	Tuple Type	Operand 1	Operand 2	Operand 3	Operand 4
A	NA	ModRM:reg (w)	ModRM:r/m (r)	NA	NA
B	Tuple1 Fixed	ModRM:reg (w)	ModRM:r/m (r)	NA	NA

### Description

Converts a double-precision floating-point value in the source operand (the second operand) to a signed doubleword integer in the destination operand (first operand). The source operand can be an XMM register or a 64-bit memory location. The destination operand is a general-purpose register. When the source operand is an XMM register, the double-precision floating-point value is contained in the low quadword of the register.

When a conversion is inexact, the value returned is rounded according to the rounding control bits in the MXCSR register.

If a converted result exceeds the range limits of signed doubleword integer (in non-64-bit modes or 64-bit mode with REX.W/VEX.W/EVEX.W=0), the floating-point invalid exception is raised, and if this exception is masked, the indefinite integer value (80000000H) is returned.

If a converted result exceeds the range limits of signed quadword integer (in 64-bit mode and REX.W/VEX.W/EVEX.W = 1), the floating-point invalid exception is raised, and if this exception is masked, the indefinite integer value (80000000\_00000000H) is returned.

Legacy SSE instruction: Use of the REX.W prefix promotes the instruction to produce 64-bit data in 64-bit mode. See the summary chart at the beginning of this section for encoding data and limits.

Note: VEX.vvvv and EVEX.vvvv are reserved and must be 1111b, otherwise instructions will #UD.

Software should ensure VCVTSD2SI is encoded with VEX.L=0. Encoding VCVTSD2SI with VEX.L=1 may encounter unpredictable behavior across different processor generations.

## Operation

### VCVTSD2SI (EVEX encoded version)

```

IF SRC *is register* AND (EVEX.b = 1)
    THEN
        SET_RM(EVEX.RC);
    ELSE
        SET_RM(MXCSR.RM);
FI;
IF 64-Bit Mode and OperandSize = 64
    THEN DEST[63:0] ← Convert_Double_Precision_Floating_Point_To_Integer(SRC[63:0]);
    ELSE DEST[31:0] ← Convert_Double_Precision_Floating_Point_To_Integer(SRC[63:0]);
FI

```

### (V)CVTSD2SI

```

IF 64-Bit Mode and OperandSize = 64
    THEN
        DEST[63:0] ← Convert_Double_Precision_Floating_Point_To_Integer(SRC[63:0]);
    ELSE
        DEST[31:0] ← Convert_Double_Precision_Floating_Point_To_Integer(SRC[63:0]);
FI;

```

## Intel C/C++ Compiler Intrinsic Equivalent

```

VCVTSD2SI int _mm_cvtsd_i32(__m128d);
VCVTSD2SI int _mm_cvt_roundsd_i32(__m128d, int r);
VCVTSD2SI __int64 _mm_cvtsd_i64(__m128d);
VCVTSD2SI __int64 _mm_cvt_roundsd_i64(__m128d, int r);
CVTSD2SI __int64 _mm_cvtsd_si64(__m128d);
CVTSD2SI int _mm_cvtsd_si32(__m128d a)

```

## SIMD Floating-Point Exceptions

Invalid, Precision

## Other Exceptions

VEX-encoded instructions, see Exceptions Type 3;

EVEX-encoded instructions, see Exceptions Type E3NF.

#UD If VEX.vvvv != 1111B or EVEX.vvvv != 1111B.

## CVTSD2SS—Convert Scalar Double-Precision Floating-Point Value to Scalar Single-Precision Floating-Point Value

Opcode/ Instruction	Op / En	64/32 bit Mode Support	CPUID Feature Flag	Description
F2 0F 5A /r CVTSD2SS xmm1, xmm2/m64	A	V/V	SSE2	Convert one double-precision floating-point value in xmm2/m64 to one single-precision floating-point value in xmm1.
VEX.NDS.LIG.F2.0F.WIG 5A /r VCVTSD2SS xmm1, xmm2, xmm3/m64	B	V/V	AVX	Convert one double-precision floating-point value in xmm3/m64 to one single-precision floating-point value and merge with high bits in xmm2.
EVEX.NDS.LIG.F2.0F.W1 5A /r VCVTSD2SS xmm1 {k1}{z}, xmm2, xmm3/m64{er}	C	V/V	AVX512F	Convert one double-precision floating-point value in xmm3/m64 to one single-precision floating-point value and merge with high bits in xmm2 under writemask k1.

### Instruction Operand Encoding

Op/En	Tuple Type	Operand 1	Operand 2	Operand 3	Operand 4
A	NA	ModRM:reg (w)	ModRM:r/m (r)	NA	NA
B	NA	ModRM:reg (w)	VEX.vvvv	ModRM:r/m (r)	NA
C	Tuple1 Scalar	ModRM:reg (w)	EVEX.vvvv	ModRM:r/m (r)	NA

### Description

Converts a double-precision floating-point value in the “convert-from” source operand (the second operand in SSE2 version, otherwise the third operand) to a single-precision floating-point value in the destination operand.

When the “convert-from” operand is an XMM register, the double-precision floating-point value is contained in the low quadword of the register. The result is stored in the low doubleword of the destination operand. When the conversion is inexact, the value returned is rounded according to the rounding control bits in the MXCSR register.

128-bit Legacy SSE version: The “convert-from” source operand (the second operand) is an XMM register or memory location. Bits (MAXVL-1:32) of the corresponding destination register remain unchanged. The destination operand is an XMM register.

VEX.128 and EVEX encoded versions: The “convert-from” source operand (the third operand) can be an XMM register or a 64-bit memory location. The first source and destination operands are XMM registers. Bits (127:32) of the XMM register destination are copied from the corresponding bits in the first source operand. Bits (MAXVL-1:128) of the destination register are zeroed.

EVEX encoded version: the converted result is written to the low doubleword element of the destination under the writemask.

Software should ensure VCVTSD2SS is encoded with VEX.L=0. Encoding VCVTSD2SS with VEX.L=1 may encounter unpredictable behavior across different processor generations.



## Operation

### VCVTSD2SS (EVEX encoded version)

```

IF (SRC2 *is register*) AND (EVEX.b = 1)
    THEN
        SET_RM(EVEX.RC);
    ELSE
        SET_RM(MXCSR.RM);
FI;
IF k1[0] or *no writemask*
    THEN DEST[31:0] ← Convert_Double_Precision_To_Single_Precision_Floating_Point(SRC2[63:0]);
    ELSE
        IF *merging-masking* ; merging-masking
            THEN *DEST[31:0] remains unchanged*
            ELSE ; zeroing-masking
                THEN DEST[31:0] ← 0
        FI;
FI;
DEST[127:32] ← SRC1[127:32]
DEST[MAXVL-1:128] ← 0

```

### VCVTSD2SS (VEX.128 encoded version)

```

DEST[31:0] ← Convert_Double_Precision_To_Single_Precision_Floating_Point(SRC2[63:0]);
DEST[127:32] ← SRC1[127:32]
DEST[MAXVL-1:128] ← 0

```

### CVTSD2SS (128-bit Legacy SSE version)

```

DEST[31:0] ← Convert_Double_Precision_To_Single_Precision_Floating_Point(SRC[63:0]);
(* DEST[MAXVL-1:32] Unmodified *)

```

## Intel C/C++ Compiler Intrinsic Equivalent

```

VCVTSD2SS __m128_mm_mask_cvtssd_ss(__m128 s, __mmask8 k, __m128 a, __m128d b);
VCVTSD2SS __m128_mm_maskz_cvtssd_ss(__mmask8 k, __m128 a, __m128d b);
VCVTSD2SS __m128_mm_cvt_roundsd_ss(__m128 a, __m128d b, int r);
VCVTSD2SS __m128_mm_mask_cvt_roundsd_ss(__m128 s, __mmask8 k, __m128 a, __m128d b, int r);
VCVTSD2SS __m128_mm_maskz_cvt_roundsd_ss(__mmask8 k, __m128 a, __m128d b, int r);
CVTSD2SS __m128_mm_cvtssd_ss(__m128 a, __m128d b)

```

## SIMD Floating-Point Exceptions

Overflow, Underflow, Invalid, Precision, Denormal

## Other Exceptions

VEX-encoded instructions, see Exceptions Type 3.

EVEX-encoded instructions, see Exceptions Type E3.

**CVTISI2SD—Convert Doubleword Integer to Scalar Double-Precision Floating-Point Value**

Opcode/ Instruction	Op / En	64/32 bit Mode Support	CPUID Feature Flag	Description
F2 OF 2A /r CVTISI2SD xmm1, r32/m32	A	V/V	SSE2	Convert one signed doubleword integer from r32/m32 to one double-precision floating-point value in xmm1.
F2 REX.W OF 2A /r CVTISI2SD xmm1, r/m64	A	V/N.E.	SSE2	Convert one signed quadword integer from r/m64 to one double-precision floating-point value in xmm1.
VEX.NDS.LIG.F2.OF.W0 2A /r VCVTISI2SD xmm1, xmm2, r/m32	B	V/V	AVX	Convert one signed doubleword integer from r/m32 to one double-precision floating-point value in xmm1.
VEX.NDS.LIG.F2.OF.W1 2A /r VCVTISI2SD xmm1, xmm2, r/m64	B	V/N.E. <sup>1</sup>	AVX	Convert one signed quadword integer from r/m64 to one double-precision floating-point value in xmm1.
EVEX.NDS.LIG.F2.OF.W0 2A /r VCVTISI2SD xmm1, xmm2, r/m32	C	V/V	AVX512F	Convert one signed doubleword integer from r/m32 to one double-precision floating-point value in xmm1.
EVEX.NDS.LIG.F2.OF.W1 2A /r VCVTISI2SD xmm1, xmm2, r/m64{er}	C	V/N.E. <sup>1</sup>	AVX512F	Convert one signed quadword integer from r/m64 to one double-precision floating-point value in xmm1.

**NOTES:**

1. VEX.W1/EVEX.W1 in non-64 bit is ignored; the instructions behaves as if the W0 version is used.

**Instruction Operand Encoding**

Op/En	Tuple Type	Operand 1	Operand 2	Operand 3	Operand 4
A	NA	ModRM:reg (w)	ModRM:r/m (r)	NA	NA
B	NA	ModRM:reg (w)	VEX.vvvv	ModRM:r/m (r)	NA
C	Tuple1 Scalar	ModRM:reg (w)	EVEX.vvvv	ModRM:r/m (r)	NA

**Description**

Converts a signed doubleword integer (or signed quadword integer if operand size is 64 bits) in the “convert-from” source operand to a double-precision floating-point value in the destination operand. The result is stored in the low quadword of the destination operand, and the high quadword left unchanged. When conversion is inexact, the value returned is rounded according to the rounding control bits in the MXCSR register.

The second source operand can be a general-purpose register or a 32/64-bit memory location. The first source and destination operands are XMM registers.

128-bit Legacy SSE version: Use of the REX.W prefix promotes the instruction to 64-bit operands. The “convert-from” source operand (the second operand) is a general-purpose register or memory location. The destination is an XMM register Bits (MAXVL-1:64) of the corresponding destination register remain unchanged.

VEX.128 and EVEX encoded versions: The “convert-from” source operand (the third operand) can be a general-purpose register or a memory location. The first source and destination operands are XMM registers. Bits (127:64) of the XMM register destination are copied from the corresponding bits in the first source operand. Bits (MAXVL-1:128) of the destination register are zeroed.

EVEX.W0 version: attempt to encode this instruction with EVEX embedded rounding is ignored.

VEX.W1 and EVEX.W1 versions: promotes the instruction to use 64-bit input value in 64-bit mode.

Software should ensure VCVTISI2SD is encoded with VEX.L=0. Encoding VCVTISI2SD with VEX.L=1 may encounter unpredictable behavior across different processor generations.

**Operation****VCVTSI2SD (EVEX encoded version)**

IF (SRC2 \*is register\*) AND (EVEX.b = 1)

THEN

SET\_RM(EVEX.RC);

ELSE

SET\_RM(MXCSR.RM);

FI;

IF 64-Bit Mode And OperandSize = 64

THEN

DEST[63:0] ← Convert\_Integer\_To\_Double\_Precision\_Floating\_Point(SRC2[63:0]);

ELSE

DEST[63:0] ← Convert\_Integer\_To\_Double\_Precision\_Floating\_Point(SRC2[31:0]);

FI;

DEST[127:64] ← SRC1[127:64]

DEST[MAXVL-1:128] ← 0

**VCVTSI2SD (VEX.128 encoded version)**

IF 64-Bit Mode And OperandSize = 64

THEN

DEST[63:0] ← Convert\_Integer\_To\_Double\_Precision\_Floating\_Point(SRC2[63:0]);

ELSE

DEST[63:0] ← Convert\_Integer\_To\_Double\_Precision\_Floating\_Point(SRC2[31:0]);

FI;

DEST[127:64] ← SRC1[127:64]

DEST[MAXVL-1:128] ← 0

**CVTSI2SD**

IF 64-Bit Mode And OperandSize = 64

THEN

DEST[63:0] ← Convert\_Integer\_To\_Double\_Precision\_Floating\_Point(SRC[63:0]);

ELSE

DEST[63:0] ← Convert\_Integer\_To\_Double\_Precision\_Floating\_Point(SRC[31:0]);

FI;

DEST[MAXVL-1:64] (Unmodified)

**Intel C/C++ Compiler Intrinsic Equivalent**

VCVTSI2SD \_\_m128d \_mm\_cvti32\_sd(\_\_m128d s, int a);

VCVTSI2SD \_\_m128d \_mm\_cvti64\_sd(\_\_m128d s, \_\_int64 a);

VCVTSI2SD \_\_m128d \_mm\_cvt\_roundi64\_sd(\_\_m128d s, \_\_int64 a, int r);

CVTSI2SD \_\_m128d \_mm\_cvtsi64\_sd(\_\_m128d s, \_\_int64 a);

CVTSI2SD \_\_m128d \_mm\_cvtsi32\_sd(\_\_m128d a, int b)

**SIMD Floating-Point Exceptions**

Precision

**Other Exceptions**

VEX-encoded instructions, see Exceptions Type 3 if W1, else Type 5.

EVEX-encoded instructions, see Exceptions Type E3NF if W1, else Type E10NF.

## CVTISI2SS—Convert Doubleword Integer to Scalar Single-Precision Floating-Point Value

Opcode/ Instruction	Op / En	64/32 bit Mode Support	CPUID Feature Flag	Description
F3 OF 2A /r CVTISI2SS xmm1, r/m32	A	V/V	SSE	Convert one signed doubleword integer from r/m32 to one single-precision floating-point value in xmm1.
F3 REX.W OF 2A /r CVTISI2SS xmm1, r/m64	A	V/N.E.	SSE	Convert one signed quadword integer from r/m64 to one single-precision floating-point value in xmm1.
VEX.NDS.LIG.F3.OF.W0 2A /r VCVTISI2SS xmm1, xmm2, r/m32	B	V/V	AVX	Convert one signed doubleword integer from r/m32 to one single-precision floating-point value in xmm1.
VEX.NDS.LIG.F3.OF.W1 2A /r VCVTISI2SS xmm1, xmm2, r/m64	B	V/N.E. <sup>1</sup>	AVX	Convert one signed quadword integer from r/m64 to one single-precision floating-point value in xmm1.
EVEX.NDS.LIG.F3.OF.W0 2A /r VCVTISI2SS xmm1, xmm2, r/m32{er}	C	V/V	AVX512F	Convert one signed doubleword integer from r/m32 to one single-precision floating-point value in xmm1.
EVEX.NDS.LIG.F3.OF.W1 2A /r VCVTISI2SS xmm1, xmm2, r/m64{er}	C	V/N.E. <sup>1</sup>	AVX512F	Convert one signed quadword integer from r/m64 to one single-precision floating-point value in xmm1.

### NOTES:

1. VEX.W1/EVEX.W1 in non-64 bit is ignored; the instructions behaves as if the W0 version is used.

### Instruction Operand Encoding

Op/En	Tuple Type	Operand 1	Operand 2	Operand 3	Operand 4
A	NA	ModRM:reg (w)	ModRM:r/m (r)	NA	NA
B	NA	ModRM:reg (w)	VEX.vvvv	ModRM:r/m (r)	NA
C	Tuple1 Scalar	ModRM:reg (w)	EVEX.vvvv	ModRM:r/m (r)	NA

### Description

Converts a signed doubleword integer (or signed quadword integer if operand size is 64 bits) in the “convert-from” source operand to a single-precision floating-point value in the destination operand (first operand). The “convert-from” source operand can be a general-purpose register or a memory location. The destination operand is an XMM register. The result is stored in the low doubleword of the destination operand, and the upper three doublewords are left unchanged. When a conversion is inexact, the value returned is rounded according to the rounding control bits in the MXCSR register or the embedded rounding control bits.

128-bit Legacy SSE version: In 64-bit mode, Use of the REX.W prefix promotes the instruction to use 64-bit input value. The “convert-from” source operand (the second operand) is a general-purpose register or memory location. Bits (MAXVL-1:32) of the corresponding destination register remain unchanged.

VEX.128 and EVEX encoded versions: The “convert-from” source operand (the third operand) can be a general-purpose register or a memory location. The first source and destination operands are XMM registers. Bits (127:32) of the XMM register destination are copied from corresponding bits in the first source operand. Bits (MAXVL-1:128) of the destination register are zeroed.

EVEX encoded version: the converted result in written to the low doubleword element of the destination under the writemask.

Software should ensure VCVTISI2SS is encoded with VEX.L=0. Encoding VCVTISI2SS with VEX.L=1 may encounter unpredictable behavior across different processor generations.

## Operation

### VCVTSI2SS (EVEX encoded version)

```

IF (SRC2 *is register*) AND (EVEX.b = 1)
    THEN
        SET_RM(EVEX.RC);
    ELSE
        SET_RM(MXCSR.RM);
FI;
IF 64-Bit Mode And OperandSize = 64
    THEN
        DEST[31:0] ← Convert_Integer_To_Single_Precision_Floating_Point(SRC[63:0]);
    ELSE
        DEST[31:0] ← Convert_Integer_To_Single_Precision_Floating_Point(SRC[31:0]);
FI;
DEST[127:32] ← SRC1[127:32]
DEST[MAXVL-1:128] ← 0

```

### VCVTSI2SS (VEX.128 encoded version)

```

IF 64-Bit Mode And OperandSize = 64
    THEN
        DEST[31:0] ← Convert_Integer_To_Single_Precision_Floating_Point(SRC[63:0]);
    ELSE
        DEST[31:0] ← Convert_Integer_To_Single_Precision_Floating_Point(SRC[31:0]);
FI;
DEST[127:32] ← SRC1[127:32]
DEST[MAXVL-1:128] ← 0

```

### CVTSI2SS (128-bit Legacy SSE version)

```

IF 64-Bit Mode And OperandSize = 64
    THEN
        DEST[31:0] ← Convert_Integer_To_Single_Precision_Floating_Point(SRC[63:0]);
    ELSE
        DEST[31:0] ← Convert_Integer_To_Single_Precision_Floating_Point(SRC[31:0]);
FI;
DEST[MAXVL-1:32] (Unmodified)

```

## Intel C/C++ Compiler Intrinsic Equivalent

```

VCVTSI2SS __m128 _mm_cvtsi32_ss(__m128 s, int a);
VCVTSI2SS __m128 _mm_cvt_roundi32_ss(__m128 s, int a, int r);
VCVTSI2SS __m128 _mm_cvtsi64_ss(__m128 s, __int64 a);
VCVTSI2SS __m128 _mm_cvt_roundi64_ss(__m128 s, __int64 a, int r);
CVTSI2SS __m128 _mm_cvtsi64_ss(__m128 s, __int64 a);
CVTSI2SS __m128 _mm_cvtsi32_ss(__m128 a, int b);

```

## SIMD Floating-Point Exceptions

Precision

## Other Exceptions

VEX-encoded instructions, see Exceptions Type 3.  
EVEX-encoded instructions, see Exceptions Type E3NF.

## CVTSS2SD—Convert Scalar Single-Precision Floating-Point Value to Scalar Double-Precision Floating-Point Value

Opcode/ Instruction	Op / En	64/32 bit Mode Support	CPUID Feature Flag	Description
F3 0F 5A /r CVTSS2SD xmm1, xmm2/m32	A	V/V	SSE2	Convert one single-precision floating-point value in xmm2/m32 to one double-precision floating-point value in xmm1.
VEX.NDS.LIG.F3.0F.WIG 5A /r VCVTSS2SD xmm1, xmm2, xmm3/m32	B	V/V	AVX	Convert one single-precision floating-point value in xmm3/m32 to one double-precision floating-point value and merge with high bits of xmm2.
EVEX.NDS.LIG.F3.0F.W0 5A /r VCVTSS2SD xmm1 {k1}{z}, xmm2, xmm3/m32{sae}	C	V/V	AVX512F	Convert one single-precision floating-point value in xmm3/m32 to one double-precision floating-point value and merge with high bits of xmm2 under writemask k1.

### Instruction Operand Encoding

Op/En	Tuple Type	Operand 1	Operand 2	Operand 3	Operand 4
A	NA	ModRM:reg (w)	ModRM:r/m (r)	NA	NA
B	NA	ModRM:reg (w)	VEX.vvvv	ModRM:r/m (r)	NA
C	Tuple1 Scalar	ModRM:reg (w)	EVEX.vvvv	ModRM:r/m (r)	NA

### Description

Converts a single-precision floating-point value in the “convert-from” source operand to a double-precision floating-point value in the destination operand. When the “convert-from” source operand is an XMM register, the single-precision floating-point value is contained in the low doubleword of the register. The result is stored in the low quadword of the destination operand.

128-bit Legacy SSE version: The “convert-from” source operand (the second operand) is an XMM register or memory location. Bits (MAXVL-1:64) of the corresponding destination register remain unchanged. The destination operand is an XMM register.

VEX.128 and EVEX encoded versions: The “convert-from” source operand (the third operand) can be an XMM register or a 32-bit memory location. The first source and destination operands are XMM registers. Bits (127:64) of the XMM register destination are copied from the corresponding bits in the first source operand. Bits (MAXVL-1:128) of the destination register are zeroed.

Software should ensure VCVTSS2SD is encoded with VEX.L=0. Encoding VCVTSS2SD with VEX.L=1 may encounter unpredictable behavior across different processor generations.

### Operation

#### VCVTSS2SD (EVEX encoded version)

IF k1[0] or \*no writemask\*

THEN DEST[63:0] ← Convert\_Single\_Precision\_To\_Double\_Precision\_Floating\_Point(SRC2[31:0]);

ELSE

IF \*merging-masking\* ; merging-masking

THEN \*DEST[63:0] remains unchanged\*

ELSE ; zeroing-masking

THEN DEST[63:0] = 0

FI;

FI;

DEST[127:64] ← SRC1[127:64]

DEST[MAXVL-1:128] ← 0

**VCVTSS2SD (VEX.128 encoded version)**

DEST[63:0] ← Convert\_Single\_Precision\_To\_Double\_Precision\_Floating\_Point(SRC2[31:0])

DEST[127:64] ← SRC1[127:64]

DEST[MAXVL-1:128] ← 0

**CVTSS2SD (128-bit Legacy SSE version)**

DEST[63:0] ← Convert\_Single\_Precision\_To\_Double\_Precision\_Floating\_Point(SRC[31:0]);

DEST[MAXVL-1:64] (Unmodified)

**Intel C/C++ Compiler Intrinsic Equivalent**

VCVTSS2SD \_\_m128d \_\_mm\_cvt\_roundss\_sd(\_\_m128d a, \_\_m128 b, int r);

VCVTSS2SD \_\_m128d \_\_mm\_mask\_cvt\_roundss\_sd(\_\_m128d s, \_\_mmask8 m, \_\_m128d a, \_\_m128 b, int r);

VCVTSS2SD \_\_m128d \_\_mm\_maskz\_cvt\_roundss\_sd(\_\_mmask8 k, \_\_m128d a, \_\_m128 a, int r);

VCVTSS2SD \_\_m128d \_\_mm\_mask\_cvtss\_sd(\_\_m128d s, \_\_mmask8 m, \_\_m128d a, \_\_m128 b);

VCVTSS2SD \_\_m128d \_\_mm\_maskz\_cvtss\_sd(\_\_mmask8 m, \_\_m128d a, \_\_m128 b);

CVTSS2SD \_\_m128d \_\_mm\_cvtss\_sd(\_\_m128d a, \_\_m128 a);

**SIMD Floating-Point Exceptions**

Invalid, Denormal

**Other Exceptions**

VEX-encoded instructions, see Exceptions Type 3.

EVEX-encoded instructions, see Exceptions Type E3.

## CVTSS2SI—Convert Scalar Single-Precision Floating-Point Value to Doubleword Integer

Opcode/ Instruction	Op / En	64/32 bit Mode Support	CPUID Feature Flag	Description
F3 0F 2D /r CVTSS2SI r32, xmm1/m32	A	V/V	SSE	Convert one single-precision floating-point value from xmm1/m32 to one signed doubleword integer in r32.
F3 REX.W 0F 2D /r CVTSS2SI r64, xmm1/m32	A	V/N.E.	SSE	Convert one single-precision floating-point value from xmm1/m32 to one signed quadword integer in r64.
VEX.LIG.F3.0F.W0 2D /r <sup>1</sup> VCVTSS2SI r32, xmm1/m32	A	V/V	AVX	Convert one single-precision floating-point value from xmm1/m32 to one signed doubleword integer in r32.
VEX.LIG.F3.0F.W1 2D /r <sup>1</sup> VCVTSS2SI r64, xmm1/m32	A	V/N.E. <sup>2</sup>	AVX	Convert one single-precision floating-point value from xmm1/m32 to one signed quadword integer in r64.
EVEX.LIG.F3.0F.W0 2D /r VCVTSS2SI r32, xmm1/m32{er}	B	V/V	AVX512F	Convert one single-precision floating-point value from xmm1/m32 to one signed doubleword integer in r32.
EVEX.LIG.F3.0F.W1 2D /r VCVTSS2SI r64, xmm1/m32{er}	B	V/N.E. <sup>2</sup>	AVX512F	Convert one single-precision floating-point value from xmm1/m32 to one signed quadword integer in r64.

### NOTES:

- Software should ensure VCVTSS2SI is encoded with VEX.L=0. Encoding VCVTSS2SI with VEX.L=1 may encounter unpredictable behavior across different processor generations.
- VEX.W1/EVEX.W1 in non-64 bit is ignored; the instructions behaves as if the W0 version is used.

### Instruction Operand Encoding

Op/En	Tuple Type	Operand 1	Operand 2	Operand 3	Operand 4
A	NA	ModRM:reg (w)	ModRM:r/m (r)	NA	NA
B	Tuple1 Fixed	ModRM:reg (w)	ModRM:r/m (r)	NA	NA

### Description

Converts a single-precision floating-point value in the source operand (the second operand) to a signed doubleword integer (or signed quadword integer if operand size is 64 bits) in the destination operand (the first operand). The source operand can be an XMM register or a memory location. The destination operand is a general-purpose register. When the source operand is an XMM register, the single-precision floating-point value is contained in the low doubleword of the register.

When a conversion is inexact, the value returned is rounded according to the rounding control bits in the MXCSR register or the embedded rounding control bits. If a converted result cannot be represented in the destination format, the floating-point invalid exception is raised, and if this exception is masked, the indefinite integer value ( $2^{w-1}$ , where  $w$  represents the number of bits in the destination format) is returned.

Legacy SSE instructions: In 64-bit mode, Use of the REX.W prefix promotes the instruction to produce 64-bit data. See the summary chart at the beginning of this section for encoding data and limits.

VEX.W1 and EVEX.W1 versions: promotes the instruction to produce 64-bit data in 64-bit mode.

Note: VEX.vvvv and EVEX.vvvv are reserved and must be 1111b, otherwise instructions will #UD.

Software should ensure VCVTSS2SI is encoded with VEX.L=0. Encoding VCVTSS2SI with VEX.L=1 may encounter unpredictable behavior across different processor generations.



## Operation

### VCVTSS2SI (EVEX encoded version)

IF (SRC \*is register\*) AND (EVEX.b = 1)

THEN

SET\_RM(EVEX.RC);

ELSE

SET\_RM(MXCSR.RM);

FI;

IF 64-bit Mode and OperandSize = 64

THEN

DEST[63:0] ← Convert\_Single\_Precision\_Floating\_Point\_To\_Integer(SRC[31:0]);

ELSE

DEST[31:0] ← Convert\_Single\_Precision\_Floating\_Point\_To\_Integer(SRC[31:0]);

FI;

### (V)CVTSS2SI (Legacy and VEX.128 encoded version)

IF 64-bit Mode and OperandSize = 64

THEN

DEST[63:0] ← Convert\_Single\_Precision\_Floating\_Point\_To\_Integer(SRC[31:0]);

ELSE

DEST[31:0] ← Convert\_Single\_Precision\_Floating\_Point\_To\_Integer(SRC[31:0]);

FI;

## Intel C/C++ Compiler Intrinsic Equivalent

VCVTSS2SI int \_\_mm\_cvtss\_i32( \_\_m128 a);

VCVTSS2SI int \_\_mm\_cvt\_roundss\_i32( \_\_m128 a, int r);

VCVTSS2SI \_\_int64 \_\_mm\_cvtss\_i64( \_\_m128 a);

VCVTSS2SI \_\_int64 \_\_mm\_cvt\_roundss\_i64( \_\_m128 a, int r);

## SIMD Floating-Point Exceptions

Invalid, Precision

## Other Exceptions

VEX-encoded instructions, see Exceptions Type 3; additionally

#UD If VEX.vvvv != 1111B.

EVEX-encoded instructions, see Exceptions Type E3NF.

## CVTTPD2DQ—Convert with Truncation Packed Double-Precision Floating-Point Values to Packed Doubleword Integers

Opcode/ Instruction	Op/ En	64/32 bit Mode Support	CPUID Feature Flag	Description
66 0F E6 /r CVTTPD2DQ xmm1, xmm2/m128	A	V/V	SSE2	Convert two packed double-precision floating-point values in xmm2/mem to two signed doubleword integers in xmm1 using truncation.
VEX.128.66.0F.WIG E6 /r VCVTPD2DQ xmm1, xmm2/m128	A	V/V	AVX	Convert two packed double-precision floating-point values in xmm2/mem to two signed doubleword integers in xmm1 using truncation.
VEX.256.66.0F.WIG E6 /r VCVTPD2DQ xmm1, ymm2/m256	A	V/V	AVX	Convert four packed double-precision floating-point values in ymm2/mem to four signed doubleword integers in xmm1 using truncation.
EVEX.128.66.0F.W1 E6 /r VCVTPD2DQ xmm1 {k1}{z}, xmm2/m128/m64bcst	B	V/V	AVX512VL AVX512F	Convert two packed double-precision floating-point values in xmm2/m128/m64bcst to two signed doubleword integers in xmm1 using truncation subject to writemask k1.
EVEX.256.66.0F.W1 E6 /r VCVTPD2DQ xmm1 {k1}{z}, ymm2/m256/m64bcst	B	V/V	AVX512VL AVX512F	Convert four packed double-precision floating-point values in ymm2/m256/m64bcst to four signed doubleword integers in xmm1 using truncation subject to writemask k1.
EVEX.512.66.0F.W1 E6 /r VCVTPD2DQ ymm1 {k1}{z}, zmm2/m512/m64bcst{sae}	B	V/V	AVX512F	Convert eight packed double-precision floating-point values in zmm2/m512/m64bcst to eight signed doubleword integers in ymm1 using truncation subject to writemask k1.

### Instruction Operand Encoding

Op/En	Tuple Type	Operand 1	Operand 2	Operand 3	Operand 4
A	NA	ModRM:reg (w)	ModRM:r/m (r)	NA	NA
B	Full	ModRM:reg (w)	ModRM:r/m (r)	NA	NA

### Description

Converts two, four or eight packed double-precision floating-point values in the source operand (second operand) to two, four or eight packed signed doubleword integers in the destination operand (first operand).

When a conversion is inexact, a truncated (round toward zero) value is returned. If a converted result is larger than the maximum signed doubleword integer, the floating-point invalid exception is raised, and if this exception is masked, the indefinite integer value (80000000H) is returned.

EVEX encoded versions: The source operand is a ZMM/YMM/XMM register, a 512/256/128-bit memory location, or a 512/256/128-bit vector broadcasted from a 64-bit memory location. The destination operand is a YMM/XMM/XMM (low 64 bits) register conditionally updated with writemask k1. The upper bits (MAXVL-1:256) of the corresponding destination are zeroed.

VEX.256 encoded version: The source operand is a YMM register or 256-bit memory location. The destination operand is an XMM register. The upper bits (MAXVL-1:128) of the corresponding ZMM register destination are zeroed.

VEX.128 encoded version: The source operand is an XMM register or 128-bit memory location. The destination operand is a XMM register. The upper bits (MAXVL-1:64) of the corresponding ZMM register destination are zeroed.

128-bit Legacy SSE version: The source operand is an XMM register or 128-bit memory location. The destination operand is an XMM register. The upper bits (MAXVL-1:128) of the corresponding ZMM register destination are unmodified.

Note: VEX.vvvv and EVEX.vvvv are reserved and must be 1111b, otherwise instructions will #UD.

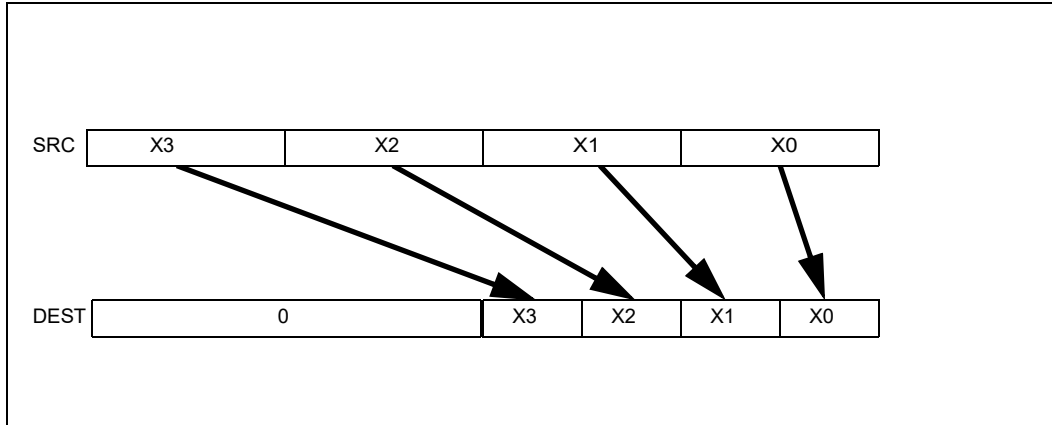

Figure 3-15. VCVTTPD2DQ (VEX.256 encoded version)

### Operation

**VCVTTPD2DQ (EVEX encoded versions) when src operand is a register**

(KL, VL) = (2, 128), (4, 256), (8, 512)

```

FOR j ← 0 TO KL-1
  i ← j * 32
  k ← j * 64
  IF k1[j] OR *no writemask*
    THEN DEST[i+31:i] ←
      Convert_Double_Precision_Floating_Point_To_Integer_Truncate(SRC[k+63:k])
  ELSE
    IF *merging-masking*           ; merging-masking
      THEN *DEST[i+31:i] remains unchanged*
    ELSE                             ; zeroing-masking
      DEST[i+31:i] ← 0
    FI
  FI;
ENDFOR
DEST[MAXVL-1:VL/2] ← 0

```

**VCVTPD2DQ (EVEX encoded versions) when src operand is a memory source**

(KL, VL) = (2, 128), (4, 256), (8, 512)

```

FOR j ← 0 TO KL-1
  i ← j * 32
  k ← j * 64
  IF k1[j] OR *no writemask*
    THEN
      IF (EVEX.b = 1)
        THEN
          DEST[i+31:i] ←
          Convert_Double_Precision_Floating_Point_To_Integer_Truncate(SRC[63:0])
        ELSE
          DEST[i+31:i] ←
          Convert_Double_Precision_Floating_Point_To_Integer_Truncate(SRC[k+63:k])
      FI;
    ELSE
      IF *merging-masking*           ; merging-masking
        THEN *DEST[i+31:i] remains unchanged*
      ELSE                             ; zeroing-masking
        DEST[i+31:i] ← 0
      FI
    FI;
ENDFOR
DEST[MAXVL-1:VL/2] ← 0

```

**VCVTPD2DQ (VEX.256 encoded version)**

```

DEST[31:0] ← Convert_Double_Precision_Floating_Point_To_Integer_Truncate(SRC[63:0])
DEST[63:32] ← Convert_Double_Precision_Floating_Point_To_Integer_Truncate(SRC[127:64])
DEST[95:64] ← Convert_Double_Precision_Floating_Point_To_Integer_Truncate(SRC[191:128])
DEST[127:96] ← Convert_Double_Precision_Floating_Point_To_Integer_Truncate(SRC[255:192])
DEST[MAXVL-1:128] ← 0

```

**VCVTPD2DQ (VEX.128 encoded version)**

```

DEST[31:0] ← Convert_Double_Precision_Floating_Point_To_Integer_Truncate(SRC[63:0])
DEST[63:32] ← Convert_Double_Precision_Floating_Point_To_Integer_Truncate(SRC[127:64])
DEST[MAXVL-1:64] ← 0

```

**CVTTPD2DQ (128-bit Legacy SSE version)**

```

DEST[31:0] ← Convert_Double_Precision_Floating_Point_To_Integer_Truncate(SRC[63:0])
DEST[63:32] ← Convert_Double_Precision_Floating_Point_To_Integer_Truncate(SRC[127:64])
DEST[127:64] ← 0
DEST[MAXVL-1:128] (unmodified)

```

### Intel C/C++ Compiler Intrinsic Equivalent

```

VCVTPD2DQ __m256i __mm512_cvttpd_epi32( __m512d a);
VCVTPD2DQ __m256i __mm512_mask_cvttpd_epi32( __m256i s, __mmask8 k, __m512d a);
VCVTPD2DQ __m256i __mm512_maskz_cvttpd_epi32( __mmask8 k, __m512d a);
VCVTPD2DQ __m256i __mm512_cvtt_roundpd_epi32( __m512d a, int sae);
VCVTPD2DQ __m256i __mm512_mask_cvtt_roundpd_epi32( __m256i s, __mmask8 k, __m512d a, int sae);
VCVTPD2DQ __m256i __mm512_maskz_cvtt_roundpd_epi32( __mmask8 k, __m512d a, int sae);
VCVTPD2DQ __m128i __mm256_mask_cvttpd_epi32( __m128i s, __mmask8 k, __m256d a);
VCVTPD2DQ __m128i __mm256_maskz_cvttpd_epi32( __mmask8 k, __m256d a);
VCVTPD2DQ __m128i __mm_mask_cvttpd_epi32( __m128i s, __mmask8 k, __m128d a);
VCVTPD2DQ __m128i __mm_maskz_cvttpd_epi32( __mmask8 k, __m128d a);
VCVTPD2DQ __m128i __mm256_cvttpd_epi32( __m256d src);
CVTTPD2DQ __m128i __mm_cvttpd_epi32( __m128d src);

```

### SIMD Floating-Point Exceptions

Invalid, Precision

### Other Exceptions

VEX-encoded instructions, see Exceptions Type 2;

EVEX-encoded instructions, see Exceptions Type E2.

#UD If VEX.vvvv != 1111B or EVEX.vvvv != 1111B.

## CVTTPD2PI—Convert with Truncation Packed Double-Precision FP Values to Packed Dword Integers

Opcode/ Instruction	Op/ En	64-Bit Mode	Compat/ Leg Mode	Description
66 0F 2C /r CVTTPD2PI <i>mm, xmm/m128</i>	RM	Valid	Valid	Convert two packed double-precision floating-point values from <i>xmm/m128</i> to two packed signed doubleword integers in <i>mm</i> using truncation.

### Instruction Operand Encoding

Op/En	Operand 1	Operand 2	Operand 3	Operand 4
RM	ModRM:reg (w)	ModRM:r/m (r)	NA	NA

### Description

Converts two packed double-precision floating-point values in the source operand (second operand) to two packed signed doubleword integers in the destination operand (first operand). The source operand can be an XMM register or a 128-bit memory location. The destination operand is an MMX technology register.

When a conversion is inexact, a truncated (round toward zero) result is returned. If a converted result is larger than the maximum signed doubleword integer, the floating-point invalid exception is raised, and if this exception is masked, the indefinite integer value (80000000H) is returned.

This instruction causes a transition from x87 FPU to MMX technology operation (that is, the x87 FPU top-of-stack pointer is set to 0 and the x87 FPU tag word is set to all 0s [valid]). If this instruction is executed while an x87 FPU floating-point exception is pending, the exception is handled before the CVTTPD2PI instruction is executed.

In 64-bit mode, use of the REX.R prefix permits this instruction to access additional registers (XMM8-XMM15).

### Operation

```
DEST[31:0] ← Convert_Double_Precision_Floating_Point_To_Integer32_Truncate(SRC[63:0]);
DEST[63:32] ← Convert_Double_Precision_Floating_Point_To_Integer32_
              Truncate(SRC[127:64]);
```

### Intel C/C++ Compiler Intrinsic Equivalent

```
CVTTPD1PI:   __m64 _mm_cvttpd_pi32(__m128d a)
```

### SIMD Floating-Point Exceptions

Invalid, Precision

### Other Mode Exceptions

See Table 22-4, "Exception Conditions for Legacy SIMD/MMX Instructions with FP Exception and 16-Byte Alignment," in the *Intel® 64 and IA-32 Architectures Software Developer's Manual, Volume 3B*.

## CVTTPS2DQ—Convert with Truncation Packed Single-Precision Floating-Point Values to Packed Signed Doubleword Integer Values

Opcode/ Instruction	Op/ En	64/32 bit Mode Support	CPUID Feature Flag	Description
F3 0F 5B /r CVTTPS2DQ xmm1, xmm2/m128	A	V/V	SSE2	Convert four packed single-precision floating-point values from xmm2/mem to four packed signed doubleword values in xmm1 using truncation.
VEX.128.F3.0F.WIG 5B /r VCVTTPS2DQ xmm1, xmm2/m128	A	V/V	AVX	Convert four packed single-precision floating-point values from xmm2/mem to four packed signed doubleword values in xmm1 using truncation.
VEX.256.F3.0F.WIG 5B /r VCVTTPS2DQ ymm1, ymm2/m256	A	V/V	AVX	Convert eight packed single-precision floating-point values from ymm2/mem to eight packed signed doubleword values in ymm1 using truncation.
EVEX.128.F3.0F.W0 5B /r VCVTTPS2DQ xmm1 {k1}{z}, xmm2/m128/m32bcst	B	V/V	AVX512VL AVX512F	Convert four packed single precision floating-point values from xmm2/m128/m32bcst to four packed signed doubleword values in xmm1 using truncation subject to writemask k1.
EVEX.256.F3.0F.W0 5B /r VCVTTPS2DQ ymm1 {k1}{z}, ymm2/m256/m32bcst	B	V/V	AVX512VL AVX512F	Convert eight packed single precision floating-point values from ymm2/m256/m32bcst to eight packed signed doubleword values in ymm1 using truncation subject to writemask k1.
EVEX.512.F3.0F.W0 5B /r VCVTTPS2DQ zmm1 {k1}{z}, zmm2/m512/m32bcst {sae}	B	V/V	AVX512F	Convert sixteen packed single-precision floating-point values from zmm2/m512/m32bcst to sixteen packed signed doubleword values in zmm1 using truncation subject to writemask k1.

### Instruction Operand Encoding

Op/En	Tuple Type	Operand 1	Operand 2	Operand 3	Operand 4
A	NA	ModRM:reg (w)	ModRM:r/m (r)	NA	NA
B	Full	ModRM:reg (w)	ModRM:r/m (r)	NA	NA

### Description

Converts four, eight or sixteen packed single-precision floating-point values in the source operand to four, eight or sixteen signed doubleword integers in the destination operand.

When a conversion is inexact, a truncated (round toward zero) value is returned. If a converted result is larger than the maximum signed doubleword integer, the floating-point invalid exception is raised, and if this exception is masked, the indefinite integer value (80000000H) is returned.

EVEX encoded versions: The source operand is a ZMM/YMM/XMM register, a 512/256/128-bit memory location or a 512/256/128-bit vector broadcasted from a 32-bit memory location. The destination operand is a ZMM/YMM/XMM register conditionally updated with writemask k1.

VEX.256 encoded version: The source operand is a YMM register or 256-bit memory location. The destination operand is a YMM register. The upper bits (MAXVL-1:256) of the corresponding ZMM register destination are zeroed.

VEX.128 encoded version: The source operand is an XMM register or 128-bit memory location. The destination operand is an XMM register. The upper bits (MAXVL-1:128) of the corresponding ZMM register destination are zeroed.

128-bit Legacy SSE version: The source operand is an XMM register or 128-bit memory location. The destination operand is an XMM register. The upper bits (MAXVL-1:128) of the corresponding ZMM register destination are unmodified.

Note: VEX.vvvv and EVEX.vvvv are reserved and must be 1111b otherwise instructions will #UD.

**Operation**

**VCVTTPS2DQ (EVEX encoded versions) when src operand is a register**  
 (KL, VL) = (4, 128), (8, 256), (16, 512)

```

FOR j ← 0 TO KL-1
  i ← j * 32
  IF k1[j] OR *no writemask*
    THEN DEST[i+31:i] ←
      Convert_Single_Precision_Floating_Point_To_Integer_Truncate(SRC[i+31:i])
    ELSE
      IF *merging-masking*           ; merging-masking
        THEN *DEST[i+31:i] remains unchanged*
      ELSE                             ; zeroing-masking
        DEST[i+31:i] ← 0
      FI
    FI;
ENDFOR
DEST[MAXVL-1:VL] ← 0

```

**VCVTTPS2DQ (EVEX encoded versions) when src operand is a memory source**  
 (KL, VL) = (4, 128), (8, 256), (16, 512)

```

FOR j ← 0 TO 15
  i ← j * 32
  IF k1[j] OR *no writemask*
    THEN
      IF (EVEX.b = 1)
        THEN
          DEST[i+31:i] ←
            Convert_Single_Precision_Floating_Point_To_Integer_Truncate(SRC[31:0])
        ELSE
          DEST[i+31:i] ←
            Convert_Single_Precision_Floating_Point_To_Integer_Truncate(SRC[i+31:i])
        FI;
      ELSE
        IF *merging-masking*           ; merging-masking
          THEN *DEST[i+31:i] remains unchanged*
        ELSE                             ; zeroing-masking
          DEST[i+31:i] ← 0
        FI
      FI;
    FI;
ENDFOR
DEST[MAXVL-1:VL] ← 0

```

**VCVTTPS2DQ (VEX.256 encoded version)**

```

DEST[31:0] ← Convert_Single_Precision_Floating_Point_To_Integer_Truncate(SRC[31:0])
DEST[63:32] ← Convert_Single_Precision_Floating_Point_To_Integer_Truncate(SRC[63:32])
DEST[95:64] ← Convert_Single_Precision_Floating_Point_To_Integer_Truncate(SRC[95:64])
DEST[127:96] ← Convert_Single_Precision_Floating_Point_To_Integer_Truncate(SRC[127:96])
DEST[159:128] ← Convert_Single_Precision_Floating_Point_To_Integer_Truncate(SRC[159:128])
DEST[191:160] ← Convert_Single_Precision_Floating_Point_To_Integer_Truncate(SRC[191:160])
DEST[223:192] ← Convert_Single_Precision_Floating_Point_To_Integer_Truncate(SRC[223:192])
DEST[255:224] ← Convert_Single_Precision_Floating_Point_To_Integer_Truncate(SRC[255:224])

```



**VCVTTPS2DQ (VEX.128 encoded version)**

DEST[31:0] ← Convert\_Single\_Precision\_Floating\_Point\_To\_Integer\_Truncate(SRC[31:0])  
 DEST[63:32] ← Convert\_Single\_Precision\_Floating\_Point\_To\_Integer\_Truncate(SRC[63:32])  
 DEST[95:64] ← Convert\_Single\_Precision\_Floating\_Point\_To\_Integer\_Truncate(SRC[95:64])  
 DEST[127:96] ← Convert\_Single\_Precision\_Floating\_Point\_To\_Integer\_Truncate(SRC[127:96])  
 DEST[MAXVL-1:128] ← 0

**CVTTPS2DQ (128-bit Legacy SSE version)**

DEST[31:0] ← Convert\_Single\_Precision\_Floating\_Point\_To\_Integer\_Truncate(SRC[31:0])  
 DEST[63:32] ← Convert\_Single\_Precision\_Floating\_Point\_To\_Integer\_Truncate(SRC[63:32])  
 DEST[95:64] ← Convert\_Single\_Precision\_Floating\_Point\_To\_Integer\_Truncate(SRC[95:64])  
 DEST[127:96] ← Convert\_Single\_Precision\_Floating\_Point\_To\_Integer\_Truncate(SRC[127:96])  
 DEST[MAXVL-1:128] (unmodified)

**Intel C/C++ Compiler Intrinsic Equivalent**

VCVTTPS2DQ \_\_m512i \_\_mm512\_cvttps\_epi32(\_\_m512 a);  
 VCVTTPS2DQ \_\_m512i \_\_mm512\_mask\_cvttps\_epi32(\_\_m512i s, \_\_mmask16 k, \_\_m512 a);  
 VCVTTPS2DQ \_\_m512i \_\_mm512\_maskz\_cvttps\_epi32(\_\_mmask16 k, \_\_m512 a);  
 VCVTTPS2DQ \_\_m512i \_\_mm512\_cvtt\_roundps\_epi32(\_\_m512 a, int sae);  
 VCVTTPS2DQ \_\_m512i \_\_mm512\_mask\_cvtt\_roundps\_epi32(\_\_m512i s, \_\_mmask16 k, \_\_m512 a, int sae);  
 VCVTTPS2DQ \_\_m512i \_\_mm512\_maskz\_cvtt\_roundps\_epi32(\_\_mmask16 k, \_\_m512 a, int sae);  
 VCVTTPS2DQ \_\_m256i \_\_mm256\_mask\_cvttps\_epi32(\_\_m256i s, \_\_mmask8 k, \_\_m256 a);  
 VCVTTPS2DQ \_\_m256i \_\_mm256\_maskz\_cvttps\_epi32(\_\_mmask8 k, \_\_m256 a);  
 VCVTTPS2DQ \_\_m128i \_\_mm\_mask\_cvttps\_epi32(\_\_m128i s, \_\_mmask8 k, \_\_m128 a);  
 VCVTTPS2DQ \_\_m128i \_\_mm\_maskz\_cvttps\_epi32(\_\_mmask8 k, \_\_m128 a);  
 VCVTTPS2DQ \_\_m256i \_\_mm256\_cvttps\_epi32(\_\_m256 a)  
 CVTTPS2DQ \_\_m128i \_\_mm\_cvttps\_epi32(\_\_m128 a)

**SIMD Floating-Point Exceptions**

Invalid, Precision

**Other Exceptions**

VEX-encoded instructions, see Exceptions Type 2; additionally

EVEX-encoded instructions, see Exceptions Type E2.

#UD If VEX.vvvv != 1111B or EVEX.vvvv != 1111B.

## CVTTPS2PI—Convert with Truncation Packed Single-Precision FP Values to Packed Dword Integers

Opcode/ Instruction	Op/ En	64-Bit Mode	Compat/ Leg Mode	Description
NP OF 2C /r CVTTPS2PI <i>mm, xmm/m64</i>	RM	Valid	Valid	Convert two single-precision floating-point values from <i>xmm/m64</i> to two signed doubleword signed integers in <i>mm</i> using truncation.

### Instruction Operand Encoding

Op/En	Operand 1	Operand 2	Operand 3	Operand 4
RM	ModRM:reg (w)	ModRM:r/m (r)	NA	NA

### Description

Converts two packed single-precision floating-point values in the source operand (second operand) to two packed signed doubleword integers in the destination operand (first operand). The source operand can be an XMM register or a 64-bit memory location. The destination operand is an MMX technology register. When the source operand is an XMM register, the two single-precision floating-point values are contained in the low quadword of the register.

When a conversion is inexact, a truncated (round toward zero) result is returned. If a converted result is larger than the maximum signed doubleword integer, the floating-point invalid exception is raised, and if this exception is masked, the indefinite integer value (80000000H) is returned.

This instruction causes a transition from x87 FPU to MMX technology operation (that is, the x87 FPU top-of-stack pointer is set to 0 and the x87 FPU tag word is set to all 0s [valid]). If this instruction is executed while an x87 FPU floating-point exception is pending, the exception is handled before the CVTTPS2PI instruction is executed.

In 64-bit mode, use of the REX.R prefix permits this instruction to access additional registers (XMM8-XMM15).

### Operation

```
DEST[31:0] ← Convert_Single_Precision_Floating_Point_To_Integer_Truncate(SRC[31:0]);
DEST[63:32] ← Convert_Single_Precision_Floating_Point_To_Integer_Truncate(SRC[63:32]);
```

### Intel C/C++ Compiler Intrinsic Equivalent

```
CVTTPS2PI:   __m64 _mm_cvttps_pi32(__m128 a)
```

### SIMD Floating-Point Exceptions

Invalid, Precision

### Other Exceptions

See Table 22-5, “Exception Conditions for Legacy SIMD/MMX Instructions with XMM and FP Exception,” in the *Intel® 64 and IA-32 Architectures Software Developer’s Manual, Volume 3B*.

## CVTTSD2SI—Convert with Truncation Scalar Double-Precision Floating-Point Value to Signed Integer

Opcode/ Instruction	Op / En	64/32 bit Mode Support	CPUID Feature Flag	Description
F2 0F 2C /r CVTTSD2SI r32, xmm1/m64	A	V/V	SSE2	Convert one double-precision floating-point value from xmm1/m64 to one signed doubleword integer in r32 using truncation.
F2 REX.W 0F 2C /r CVTTSD2SI r64, xmm1/m64	A	V/N.E.	SSE2	Convert one double-precision floating-point value from xmm1/m64 to one signed quadword integer in r64 using truncation.
VEX.LIG.F2.0F.W0 2C /r <sup>1</sup> VCVTTSD2SI r32, xmm1/m64	A	V/V	AVX	Convert one double-precision floating-point value from xmm1/m64 to one signed doubleword integer in r32 using truncation.
VEX.LIG.F2.0F.W1 2C /r <sup>1</sup> VCVTTSD2SI r64, xmm1/m64	B	V/N.E. <sup>2</sup>	AVX	Convert one double-precision floating-point value from xmm1/m64 to one signed quadword integer in r64 using truncation.
EVEX.LIG.F2.0F.W0 2C /r VCVTTSD2SI r32, xmm1/m64{sae}	B	V/V	AVX512F	Convert one double-precision floating-point value from xmm1/m64 to one signed doubleword integer in r32 using truncation.
EVEX.LIG.F2.0F.W1 2C /r VCVTTSD2SI r64, xmm1/m64{sae}	B	V/N.E. <sup>2</sup>	AVX512F	Convert one double-precision floating-point value from xmm1/m64 to one signed quadword integer in r64 using truncation.

### NOTES:

- Software should ensure VCVTTSD2SI is encoded with VEX.L=0. Encoding VCVTTSD2SI with VEX.L=1 may encounter unpredictable behavior across different processor generations.
- For this specific instruction, VEX.W/EVEX.W in non-64 bit is ignored; the instructions behaves as if the W0 version is used.

### Instruction Operand Encoding

Op/En	Tuple Type	Operand 1	Operand 2	Operand 3	Operand 4
A	NA	ModRM:reg (w)	ModRM:r/m (r)	NA	NA
B	Tuple1 Fixed	ModRM:reg (w)	ModRM:r/m (r)	NA	NA

### Description

Converts a double-precision floating-point value in the source operand (the second operand) to a signed doubleword integer (or signed quadword integer if operand size is 64 bits) in the destination operand (the first operand). The source operand can be an XMM register or a 64-bit memory location. The destination operand is a general purpose register. When the source operand is an XMM register, the double-precision floating-point value is contained in the low quadword of the register.

When a conversion is inexact, the value returned is rounded according to the rounding control bits in the MXCSR register.

If a converted result exceeds the range limits of signed doubleword integer (in non-64-bit modes or 64-bit mode with REX.W/VEX.W/EVEX.W=0), the floating-point invalid exception is raised, and if this exception is masked, the indefinite integer value (80000000H) is returned.

If a converted result exceeds the range limits of signed quadword integer (in 64-bit mode and REX.W/VEX.W/EVEX.W = 1), the floating-point invalid exception is raised, and if this exception is masked, the indefinite integer value (80000000\_00000000H) is returned.

Legacy SSE instructions: In 64-bit mode, Use of the REX.W prefix promotes the instruction to 64-bit operation. See the summary chart at the beginning of this section for encoding data and limits.

VEX.W1 and EVEX.W1 versions: promotes the instruction to produce 64-bit data in 64-bit mode.

Note: VEX.vvvv and EVEX.vvvv are reserved and must be 1111b, otherwise instructions will #UD. Software should ensure VCVTTSD2SI is encoded with VEX.L=0. Encoding VCVTTSD2SI with VEX.L=1 may encounter unpredictable behavior across different processor generations.

## Operation

### (V)CVTTSD2SI (All versions)

IF 64-Bit Mode and OperandSize = 64

THEN

DEST[63:0] ← Convert\_Double\_Precision\_Floating\_Point\_To\_Integer\_Truncate(SRC[63:0]);

ELSE

DEST[31:0] ← Convert\_Double\_Precision\_Floating\_Point\_To\_Integer\_Truncate(SRC[63:0]);

FI;

### Intel C/C++ Compiler Intrinsic Equivalent

VCVTTSD2SI int \_\_mm\_cvttssd\_i32( \_\_m128d a);

VCVTTSD2SI int \_\_mm\_cvtt\_roundssd\_i32( \_\_m128d a, int sae);

VCVTTSD2SI \_\_int64 \_\_mm\_cvttssd\_i64( \_\_m128d a);

VCVTTSD2SI \_\_int64 \_\_mm\_cvtt\_roundssd\_i64( \_\_m128d a, int sae);

CVTTSD2SI int \_\_mm\_cvttssd\_si32( \_\_m128d a);

CVTTSD2SI \_\_int64 \_\_mm\_cvttssd\_si64( \_\_m128d a);

### SIMD Floating-Point Exceptions

Invalid, Precision

### Other Exceptions

VEX-encoded instructions, see Exceptions Type 3; additionally

#UD If VEX.vvvv != 1111B.

EVEX-encoded instructions, see Exceptions Type E3NF.

## CVTTSS2SI—Convert with Truncation Scalar Single-Precision Floating-Point Value to Integer

Opcode/ Instruction	Op / En	64/32 bit Mode Support	CPUID Feature Flag	Description
F3 0F 2C /r CVTTSS2SI r32, xmm1/m32	A	V/V	SSE	Convert one single-precision floating-point value from xmm1/m32 to one signed doubleword integer in r32 using truncation.
F3 REX.W 0F 2C /r CVTTSS2SI r64, xmm1/m32	A	V/N.E.	SSE	Convert one single-precision floating-point value from xmm1/m32 to one signed quadword integer in r64 using truncation.
VEX.LIG.F3.0F.W0 2C /r <sup>1</sup> VCVTTSS2SI r32, xmm1/m32	A	V/V	AVX	Convert one single-precision floating-point value from xmm1/m32 to one signed doubleword integer in r32 using truncation.
VEX.LIG.F3.0F.W1 2C /r <sup>1</sup> VCVTTSS2SI r64, xmm1/m32	A	V/N.E. <sup>2</sup>	AVX	Convert one single-precision floating-point value from xmm1/m32 to one signed quadword integer in r64 using truncation.
EVEX.LIG.F3.0F.W0 2C /r VCVTTSS2SI r32, xmm1/m32{sae}	B	V/V	AVX512F	Convert one single-precision floating-point value from xmm1/m32 to one signed doubleword integer in r32 using truncation.
EVEX.LIG.F3.0F.W1 2C /r VCVTTSS2SI r64, xmm1/m32{sae}	B	V/N.E. <sup>2</sup>	AVX512F	Convert one single-precision floating-point value from xmm1/m32 to one signed quadword integer in r64 using truncation.

### NOTES:

- Software should ensure VCVTTSS2SI is encoded with VEX.L=0. Encoding VCVTTSS2SI with VEX.L=1 may encounter unpredictable behavior across different processor generations.
- For this specific instruction, VEX.W/EVEX.W in non-64 bit is ignored; the instructions behaves as if the W0 version is used.

### Instruction Operand Encoding

Op/En	Tuple Type	Operand 1	Operand 2	Operand 3	Operand 4
A	NA	ModRM:reg (w)	ModRM:r/m (r)	NA	NA
B	Tuple1 Fixed	ModRM:reg (w)	ModRM:r/m (r)	NA	NA

### Description

Converts a single-precision floating-point value in the source operand (the second operand) to a signed doubleword integer (or signed quadword integer if operand size is 64 bits) in the destination operand (the first operand). The source operand can be an XMM register or a 32-bit memory location. The destination operand is a general purpose register. When the source operand is an XMM register, the single-precision floating-point value is contained in the low doubleword of the register.

When a conversion is inexact, a truncated (round toward zero) result is returned. If a converted result is larger than the maximum signed doubleword integer, the floating-point invalid exception is raised. If this exception is masked, the indefinite integer value (80000000H or 80000000\_00000000H if operand size is 64 bits) is returned.

Legacy SSE instructions: In 64-bit mode, Use of the REX.W prefix promotes the instruction to 64-bit operation. See the summary chart at the beginning of this section for encoding data and limits.

VEX.W1 and EVEX.W1 versions: promotes the instruction to produce 64-bit data in 64-bit mode.

Note: VEX.vvvv and EVEX.vvvv are reserved and must be 1111b, otherwise instructions will #UD.

Software should ensure VCVTTSS2SI is encoded with VEX.L=0. Encoding VCVTTSS2SI with VEX.L=1 may encounter unpredictable behavior across different processor generations.

**Operation****(V)CVTTSS2SI (All versions)**

IF 64-Bit Mode and OperandSize = 64

THEN

DEST[63:0] ← Convert\_Single\_Precision\_Floating\_Point\_To\_Integer\_Truncate(SRC[31:0]);

ELSE

DEST[31:0] ← Convert\_Single\_Precision\_Floating\_Point\_To\_Integer\_Truncate(SRC[31:0]);

FI;

**Intel C/C++ Compiler Intrinsic Equivalent**

VCVTTSS2SI int \_\_mm\_cvtss\_i32( \_\_m128 a);

VCVTTSS2SI int \_\_mm\_cvtt\_roundss\_i32( \_\_m128 a, int sae);

VCVTTSS2SI \_\_int64 \_\_mm\_cvtss\_i64( \_\_m128 a);

VCVTTSS2SI \_\_int64 \_\_mm\_cvtt\_roundss\_i64( \_\_m128 a, int sae);

CVTTSS2SI int \_\_mm\_cvtss\_si32( \_\_m128 a);

CVTTSS2SI \_\_int64 \_\_mm\_cvtss\_si64( \_\_m128 a);

**SIMD Floating-Point Exceptions**

Invalid, Precision

**Other Exceptions**

See Exceptions Type 3; additionally

#UD If VEX.vvvv != 1111B.

EVEX-encoded instructions, see Exceptions Type E3NF.

## CWD/CDQ/CQO—Convert Word to Doubleword/Convert Doubleword to Quadword

Opcode	Instruction	Op/En	64-Bit Mode	Compat/Leg Mode	Description
99	CWD	Z0	Valid	Valid	DX:AX ← sign-extend of AX.
99	CDQ	Z0	Valid	Valid	EDX:EAX ← sign-extend of EAX.
REX.W + 99	CQO	Z0	Valid	N.E.	RDX:RAX ← sign-extend of RAX.

### Instruction Operand Encoding

Op/En	Operand 1	Operand 2	Operand 3	Operand 4
Z0	NA	NA	NA	NA

### Description

Doubles the size of the operand in register AX, EAX, or RAX (depending on the operand size) by means of sign extension and stores the result in registers DX:AX, EDX:EAX, or RDX:RAX, respectively. The CWD instruction copies the sign (bit 15) of the value in the AX register into every bit position in the DX register. The CDQ instruction copies the sign (bit 31) of the value in the EAX register into every bit position in the EDX register. The CQO instruction (available in 64-bit mode only) copies the sign (bit 63) of the value in the RAX register into every bit position in the RDX register.

The CWD instruction can be used to produce a doubleword dividend from a word before word division. The CDQ instruction can be used to produce a quadword dividend from a doubleword before doubleword division. The CQO instruction can be used to produce a double quadword dividend from a quadword before a quadword division.

The CWD and CDQ mnemonics reference the same opcode. The CWD instruction is intended for use when the operand-size attribute is 16 and the CDQ instruction for when the operand-size attribute is 32. Some assemblers may force the operand size to 16 when CWD is used and to 32 when CDQ is used. Others may treat these mnemonics as synonyms (CWD/CDQ) and use the current setting of the operand-size attribute to determine the size of values to be converted, regardless of the mnemonic used.

In 64-bit mode, use of the REX.W prefix promotes operation to 64 bits. The CQO mnemonics reference the same opcode as CWD/CDQ. See the summary chart at the beginning of this section for encoding data and limits.

### Operation

```
IF OperandSize = 16 (* CWD instruction *)
  THEN
    DX ← SignExtend(AX);
  ELSE IF OperandSize = 32 (* CDQ instruction *)
    EDX ← SignExtend(EAX); FI;
  ELSE IF 64-Bit Mode and OperandSize = 64 (* CQO instruction*)
    RDX ← SignExtend(RAX); FI;
FI;
```

### Flags Affected

None

### Exceptions (All Operating Modes)

#UD If the LOCK prefix is used.

## DAA—Decimal Adjust AL after Addition

Opcode	Instruction	Op/En	64-Bit Mode	Compat/Leg Mode	Description
27	DAA	ZO	Invalid	Valid	Decimal adjust AL after addition.

### Instruction Operand Encoding

Op/En	Operand 1	Operand 2	Operand 3	Operand 4
ZO	NA	NA	NA	NA

### Description

Adjusts the sum of two packed BCD values to create a packed BCD result. The AL register is the implied source and destination operand. The DAA instruction is only useful when it follows an ADD instruction that adds (binary addition) two 2-digit, packed BCD values and stores a byte result in the AL register. The DAA instruction then adjusts the contents of the AL register to contain the correct 2-digit, packed BCD result. If a decimal carry is detected, the CF and AF flags are set accordingly.

This instruction executes as described above in compatibility mode and legacy mode. It is not valid in 64-bit mode.

### Operation

IF 64-Bit Mode

THEN

#UD;

ELSE

old\_AL ← AL;

old\_CF ← CF;

CF ← 0;

IF (((AL AND 0FH) > 9) or AF = 1)

THEN

AL ← AL + 6;

CF ← old\_CF or (Carry from AL ← AL + 6);

AF ← 1;

ELSE

AF ← 0;

FI;

IF ((old\_AL > 99H) or (old\_CF = 1))

THEN

AL ← AL + 60H;

CF ← 1;

ELSE

CF ← 0;

FI;

FI;

### Example

```
ADD  AL, BL  Before: AL=79H BL=35H EFLAGS(OSZAPC)=XXXXXX
                After: AL=AEH BL=35H EFLAGS(OSZAPC)=110000
DAA                                Before: AL=AEH BL=35H EFLAGS(OSZAPC)=110000
                After: AL=14H BL=35H EFLAGS(OSZAPC)=X00111
DAA                                Before: AL=2EH BL=35H EFLAGS(OSZAPC)=110000
                After: AL=34H BL=35H EFLAGS(OSZAPC)=X00101
```



### Flags Affected

The CF and AF flags are set if the adjustment of the value results in a decimal carry in either digit of the result (see the “Operation” section above). The SF, ZF, and PF flags are set according to the result. The OF flag is undefined.

### Protected Mode Exceptions

#UD If the LOCK prefix is used.

### Real-Address Mode Exceptions

#UD If the LOCK prefix is used.

### Virtual-8086 Mode Exceptions

#UD If the LOCK prefix is used.

### Compatibility Mode Exceptions

#UD If the LOCK prefix is used.

### 64-Bit Mode Exceptions

#UD If in 64-bit mode.

## DAS—Decimal Adjust AL after Subtraction

Opcode	Instruction	Op/En	64-Bit Mode	Compat/Leg Mode	Description
2F	DAS	Z0	Invalid	Valid	Decimal adjust AL after subtraction.

### Instruction Operand Encoding

Op/En	Operand 1	Operand 2	Operand 3	Operand 4
Z0	NA	NA	NA	NA

### Description

Adjusts the result of the subtraction of two packed BCD values to create a packed BCD result. The AL register is the implied source and destination operand. The DAS instruction is only useful when it follows a SUB instruction that subtracts (binary subtraction) one 2-digit, packed BCD value from another and stores a byte result in the AL register. The DAS instruction then adjusts the contents of the AL register to contain the correct 2-digit, packed BCD result. If a decimal borrow is detected, the CF and AF flags are set accordingly.

This instruction executes as described above in compatibility mode and legacy mode. It is not valid in 64-bit mode.

### Operation

IF 64-Bit Mode

THEN

#UD;

ELSE

old\_AL ← AL;

old\_CF ← CF;

CF ← 0;

IF (((AL AND 0FH) > 9) or AF = 1)

THEN

AL ← AL - 6;

CF ← old\_CF or (Borrow from AL ← AL - 6);

AF ← 1;

ELSE

AF ← 0;

FI;

IF ((old\_AL > 99H) or (old\_CF = 1))

THEN

AL ← AL - 60H;

CF ← 1;

FI;

FI;

### Example

SUB AL, BL Before: AL = 35H, BL = 47H, EFLAGS(OSZAPC) = XXXXXX

After: AL = EEH, BL = 47H, EFLAGS(OSZAPC) = 010111

DAA Before: AL = EEH, BL = 47H, EFLAGS(OSZAPC) = 010111

After: AL = 88H, BL = 47H, EFLAGS(OSZAPC) = X10111

### Flags Affected

The CF and AF flags are set if the adjustment of the value results in a decimal borrow in either digit of the result (see the "Operation" section above). The SF, ZF, and PF flags are set according to the result. The OF flag is undefined.

**Protected Mode Exceptions**

#UD                    If the LOCK prefix is used.

**Real-Address Mode Exceptions**

#UD                    If the LOCK prefix is used.

**Virtual-8086 Mode Exceptions**

#UD                    If the LOCK prefix is used.

**Compatibility Mode Exceptions**

#UD                    If the LOCK prefix is used.

**64-Bit Mode Exceptions**

#UD                    If in 64-bit mode.

## DEC—Decrement by 1

Opcode	Instruction	Op/En	64-Bit Mode	Compat/Leg Mode	Description
FE /1	DEC <i>r/m8</i>	M	Valid	Valid	Decrement <i>r/m8</i> by 1.
REX + FE /1	DEC <i>r/m8</i>	M	Valid	N.E.	Decrement <i>r/m8</i> by 1.
FF /1	DEC <i>r/m16</i>	M	Valid	Valid	Decrement <i>r/m16</i> by 1.
FF /1	DEC <i>r/m32</i>	M	Valid	Valid	Decrement <i>r/m32</i> by 1.
REX.W + FF /1	DEC <i>r/m64</i>	M	Valid	N.E.	Decrement <i>r/m64</i> by 1.
48+rw	DEC <i>r16</i>	O	N.E.	Valid	Decrement <i>r16</i> by 1.
48+rd	DEC <i>r32</i>	O	N.E.	Valid	Decrement <i>r32</i> by 1.

### NOTES:

\* In 64-bit mode, *r/m8* can not be encoded to access the following byte registers if a REX prefix is used: AH, BH, CH, DH.

### Instruction Operand Encoding

Op/En	Operand 1	Operand 2	Operand 3	Operand 4
M	ModRM: <i>r/m</i> ( <i>r</i> , <i>w</i> )	NA	NA	NA
O	opcode + <i>rd</i> ( <i>r</i> , <i>w</i> )	NA	NA	NA

### Description

Subtracts 1 from the destination operand, while preserving the state of the CF flag. The destination operand can be a register or a memory location. This instruction allows a loop counter to be updated without disturbing the CF flag. (To perform a decrement operation that updates the CF flag, use a SUB instruction with an immediate operand of 1.)

This instruction can be used with a LOCK prefix to allow the instruction to be executed atomically.

In 64-bit mode, DEC *r16* and DEC *r32* are not encodable (because opcodes 48H through 4FH are REX prefixes). Otherwise, the instruction's 64-bit mode default operation size is 32 bits. Use of the REX.R prefix permits access to additional registers (R8-R15). Use of the REX.W prefix promotes operation to 64 bits.

See the summary chart at the beginning of this section for encoding data and limits.

### Operation

DEST ← DEST - 1;

### Flags Affected

The CF flag is not affected. The OF, SF, ZF, AF, and PF flags are set according to the result.

### Protected Mode Exceptions

#GP(0)	If the destination operand is located in a non-writable segment. If a memory operand effective address is outside the CS, DS, ES, FS, or GS segment limit. If the DS, ES, FS, or GS register contains a NULL segment selector.
#SS(0)	If a memory operand effective address is outside the SS segment limit.
#PF(fault-code)	If a page fault occurs.
#AC(0)	If alignment checking is enabled and an unaligned memory reference is made while the current privilege level is 3.
#UD	If the LOCK prefix is used but the destination is not a memory operand.

**Real-Address Mode Exceptions**

#GP	If a memory operand effective address is outside the CS, DS, ES, FS, or GS segment limit.
#SS	If a memory operand effective address is outside the SS segment limit.
#UD	If the LOCK prefix is used but the destination is not a memory operand.

**Virtual-8086 Mode Exceptions**

#GP(0)	If a memory operand effective address is outside the CS, DS, ES, FS, or GS segment limit.
#SS(0)	If a memory operand effective address is outside the SS segment limit.
#PF(fault-code)	If a page fault occurs.
#AC(0)	If alignment checking is enabled and an unaligned memory reference is made.
#UD	If the LOCK prefix is used but the destination is not a memory operand.

**Compatibility Mode Exceptions**

Same exceptions as in protected mode.

**64-Bit Mode Exceptions**

#SS(0)	If a memory address referencing the SS segment is in a non-canonical form.
#GP(0)	If the memory address is in a non-canonical form.
#PF(fault-code)	If a page fault occurs.
#AC(0)	If alignment checking is enabled and an unaligned memory reference is made while the current privilege level is 3.
#UD	If the LOCK prefix is used but the destination is not a memory operand.

## DIV—Unsigned Divide

Opcode	Instruction	Op/En	64-Bit Mode	Compat/Leg Mode	Description
F6 /6	DIV <i>r/m8</i>	M	Valid	Valid	Unsigned divide AX by <i>r/m8</i> , with result stored in AL ← Quotient, AH ← Remainder.
REX + F6 /6	DIV <i>r/m8</i> *	M	Valid	N.E.	Unsigned divide AX by <i>r/m8</i> , with result stored in AL ← Quotient, AH ← Remainder.
F7 /6	DIV <i>r/m16</i>	M	Valid	Valid	Unsigned divide DX:AX by <i>r/m16</i> , with result stored in AX ← Quotient, DX ← Remainder.
F7 /6	DIV <i>r/m32</i>	M	Valid	Valid	Unsigned divide EDX:EAX by <i>r/m32</i> , with result stored in EAX ← Quotient, EDX ← Remainder.
REX.W + F7 /6	DIV <i>r/m64</i>	M	Valid	N.E.	Unsigned divide RDX:RAX by <i>r/m64</i> , with result stored in RAX ← Quotient, RDX ← Remainder.

### NOTES:

\* In 64-bit mode, *r/m8* can not be encoded to access the following byte registers if a REX prefix is used: AH, BH, CH, DH.

### Instruction Operand Encoding

Op/En	Operand 1	Operand 2	Operand 3	Operand 4
M	ModRM:r/m ( <i>w</i> )	NA	NA	NA

### Description

Divides unsigned the value in the AX, DX:AX, EDX:EAX, or RDX:RAX registers (dividend) by the source operand (divisor) and stores the result in the AX (AH:AL), DX:AX, EDX:EAX, or RDX:RAX registers. The source operand can be a general-purpose register or a memory location. The action of this instruction depends on the operand size (dividend/divisor). Division using 64-bit operand is available only in 64-bit mode.

Non-integral results are truncated (chopped) towards 0. The remainder is always less than the divisor in magnitude. Overflow is indicated with the #DE (divide error) exception rather than with the CF flag.

In 64-bit mode, the instruction's default operation size is 32 bits. Use of the REX.R prefix permits access to additional registers (R8-R15). Use of the REX.W prefix promotes operation to 64 bits. In 64-bit mode when REX.W is applied, the instruction divides the unsigned value in RDX:RAX by the source operand and stores the quotient in RAX, the remainder in RDX.

See the summary chart at the beginning of this section for encoding data and limits. See Table 3-15.

**Table 3-15. DIV Action**

Operand Size	Dividend	Divisor	Quotient	Remainder	Maximum Quotient
Word/byte	AX	<i>r/m8</i>	AL	AH	255
Doubleword/word	DX:AX	<i>r/m16</i>	AX	DX	65,535
Quadword/doubleword	EDX:EAX	<i>r/m32</i>	EAX	EDX	$2^{32} - 1$
Doublequadword/quadword	RDX:RAX	<i>r/m64</i>	RAX	RDX	$2^{64} - 1$

**Operation**

```

IF SRC = 0
  THEN #DE; FI; (* Divide Error *)
IF OperandSize = 8 (* Word/Byte Operation *)
  THEN
    temp ← AX / SRC;
    IF temp > FFH
      THEN #DE; (* Divide error *)
    ELSE
      AL ← temp;
      AH ← AX MOD SRC;
    FI;
ELSE IF OperandSize = 16 (* Doubleword/word operation *)
  THEN
    temp ← DX:AX / SRC;
    IF temp > FFFFH
      THEN #DE; (* Divide error *)
    ELSE
      AX ← temp;
      DX ← DX:AX MOD SRC;
    FI;
  FI;
ELSE IF OperandSize = 32 (* Quadword/doubleword operation *)
  THEN
    temp ← EDX:EAX / SRC;
    IF temp > FFFFFFFFH
      THEN #DE; (* Divide error *)
    ELSE
      EAX ← temp;
      EDX ← EDX:EAX MOD SRC;
    FI;
  FI;
ELSE IF 64-Bit Mode and OperandSize = 64 (* Doublequadword/quadword operation *)
  THEN
    temp ← RDX:RAX / SRC;
    IF temp > FFFFFFFFFFFFFFFFH
      THEN #DE; (* Divide error *)
    ELSE
      RAX ← temp;
      RDX ← RDX:RAX MOD SRC;
    FI;
  FI;
FI;

```

**Flags Affected**

The CF, OF, SF, ZF, AF, and PF flags are undefined.

**Protected Mode Exceptions**

#DE	If the source operand (divisor) is 0 If the quotient is too large for the designated register.
#GP(0)	If a memory operand effective address is outside the CS, DS, ES, FS, or GS segment limit. If the DS, ES, FS, or GS register contains a NULL segment selector.
#SS(0)	If a memory operand effective address is outside the SS segment limit.
#PF(fault-code)	If a page fault occurs.
#AC(0)	If alignment checking is enabled and an unaligned memory reference is made while the current privilege level is 3.
#UD	If the LOCK prefix is used.

**Real-Address Mode Exceptions**

#DE	If the source operand (divisor) is 0. If the quotient is too large for the designated register.
#GP	If a memory operand effective address is outside the CS, DS, ES, FS, or GS segment limit. If the DS, ES, FS, or GS register contains a NULL segment selector.
#SS(0)	If a memory operand effective address is outside the SS segment limit.
#UD	If the LOCK prefix is used.

**Virtual-8086 Mode Exceptions**

#DE	If the source operand (divisor) is 0. If the quotient is too large for the designated register.
#GP(0)	If a memory operand effective address is outside the CS, DS, ES, FS, or GS segment limit.
#SS	If a memory operand effective address is outside the SS segment limit.
#PF(fault-code)	If a page fault occurs.
#AC(0)	If alignment checking is enabled and an unaligned memory reference is made.
#UD	If the LOCK prefix is used.

**Compatibility Mode Exceptions**

Same exceptions as in protected mode.

**64-Bit Mode Exceptions**

#SS(0)	If a memory address referencing the SS segment is in a non-canonical form.
#GP(0)	If the memory address is in a non-canonical form.
#DE	If the source operand (divisor) is 0 If the quotient is too large for the designated register.
#PF(fault-code)	If a page fault occurs.
#AC(0)	If alignment checking is enabled and an unaligned memory reference is made while the current privilege level is 3.
#UD	If the LOCK prefix is used.



## DIVPD—Divide Packed Double-Precision Floating-Point Values

Opcode/ Instruction	Op / En	64/32 bit Mode Support	CPUID Feature Flag	Description
66 0F 5E /r DIVPD xmm1, xmm2/m128	A	V/V	SSE2	Divide packed double-precision floating-point values in xmm1 by packed double-precision floating-point values in xmm2/mem.
VEX.NDS.128.66.0F.WIG 5E /r VDIVPD xmm1, xmm2, xmm3/m128	B	V/V	AVX	Divide packed double-precision floating-point values in xmm2 by packed double-precision floating-point values in xmm3/mem.
VEX.NDS.256.66.0F.WIG 5E /r VDIVPD ymm1, ymm2, ymm3/m256	B	V/V	AVX	Divide packed double-precision floating-point values in ymm2 by packed double-precision floating-point values in ymm3/mem.
EVEX.NDS.128.66.0F.W1 5E /r VDIVPD xmm1 {k1}{z}, xmm2, xmm3/m128/m64bcst	C	V/V	AVX512VL AVX512F	Divide packed double-precision floating-point values in xmm2 by packed double-precision floating-point values in xmm3/m128/m64bcst and write results to xmm1 subject to writemask k1.
EVEX.NDS.256.66.0F.W1 5E /r VDIVPD ymm1 {k1}{z}, ymm2, ymm3/m256/m64bcst	C	V/V	AVX512VL AVX512F	Divide packed double-precision floating-point values in ymm2 by packed double-precision floating-point values in ymm3/m256/m64bcst and write results to ymm1 subject to writemask k1.
EVEX.NDS.512.66.0F.W1 5E /r VDIVPD zmm1 {k1}{z}, zmm2, zmm3/m512/m64bcst{er}	C	V/V	AVX512F	Divide packed double-precision floating-point values in zmm2 by packed double-precision FP values in zmm3/m512/m64bcst and write results to zmm1 subject to writemask k1.

### Instruction Operand Encoding

Op/En	Tuple Type	Operand 1	Operand 2	Operand 3	Operand 4
A	NA	ModRM:reg (r, w)	ModRM:r/m (r)	NA	NA
B	NA	ModRM:reg (w)	VEX.vvvv	ModRM:r/m (r)	NA
C	Full	ModRM:reg (w)	EVEX.vvvv	ModRM:r/m (r)	NA

### Description

Performs a SIMD divide of the double-precision floating-point values in the first source operand by the floating-point values in the second source operand (the third operand). Results are written to the destination operand (the first operand).

EVEX encoded versions: The first source operand (the second operand) is a ZMM/YMM/XMM register. The second source operand can be a ZMM/YMM/XMM register, a 512/256/128-bit memory location or a 512/256/128-bit vector broadcasted from a 64-bit memory location. The destination operand is a ZMM/YMM/XMM register conditionally updated with writemask k1.

VEX.256 encoded version: The first source operand (the second operand) is a YMM register. The second source operand can be a YMM register or a 256-bit memory location. The destination operand is a YMM register. The upper bits (MAXVL-1:256) of the corresponding destination are zeroed.

VEX.128 encoded version: The first source operand (the second operand) is a XMM register. The second source operand can be a XMM register or a 128-bit memory location. The destination operand is a XMM register. The upper bits (MAXVL-1:128) of the corresponding destination are zeroed.

128-bit Legacy SSE version: The second source operand (the second operand) can be an XMM register or a 128-bit memory location. The destination is the same as the first source operand. The upper bits (MAXVL-1:128) of the corresponding destination are unmodified.

**Operation****VDIVPD (EVEX encoded versions)**

(KL, VL) = (2, 128), (4, 256), (8, 512)

IF (VL = 512) AND (EVEX.b = 1) AND SRC2 \*is a register\*

THEN

SET\_RM(EVEX.RC); ; refer to Table 2-4 in the *Intel® Architecture Instruction Set Extensions Programming Reference*

ELSE

SET\_RM(MXCSR.RM);

FI;

FOR j ← 0 TO KL-1

i ← j \* 64

IF k1[j] OR \*no writemask\*

THEN

IF (EVEX.b = 1) AND (SRC2 \*is memory\*)

THEN

DEST[i+63:i] ← SRC1[i+63:i] / SRC2[63:0]

ELSE

DEST[i+63:i] ← SRC1[i+63:i] / SRC2[i+63:i]

FI;

ELSE

IF \*merging-masking\* ; merging-masking

THEN \*DEST[i+63:i] remains unchanged\*

ELSE ; zeroing-masking

DEST[i+63:i] ← 0

FI

FI;

ENDFOR

DEST[MAXVL-1:VL] ← 0

**VDIVPD (VEX.256 encoded version)**

DEST[63:0] ← SRC1[63:0] / SRC2[63:0]

DEST[127:64] ← SRC1[127:64] / SRC2[127:64]

DEST[191:128] ← SRC1[191:128] / SRC2[191:128]

DEST[255:192] ← SRC1[255:192] / SRC2[255:192]

DEST[MAXVL-1:256] ← 0;

**VDIVPD (VEX.128 encoded version)**

DEST[63:0] ← SRC1[63:0] / SRC2[63:0]

DEST[127:64] ← SRC1[127:64] / SRC2[127:64]

DEST[MAXVL-1:128] ← 0;

**DIVPD (128-bit Legacy SSE version)**

DEST[63:0] ← SRC1[63:0] / SRC2[63:0]

DEST[127:64] ← SRC1[127:64] / SRC2[127:64]

DEST[MAXVL-1:128] (Unmodified)

### Intel C/C++ Compiler Intrinsic Equivalent

```

VDIVPD __m512d __mm512_div_pd( __m512d a, __m512d b);
VDIVPD __m512d __mm512_mask_div_pd(__m512d s, __mmask8 k, __m512d a, __m512d b);
VDIVPD __m512d __mm512_maskz_div_pd( __mmask8 k, __m512d a, __m512d b);
VDIVPD __m256d __mm256_mask_div_pd(__m256d s, __mmask8 k, __m256d a, __m256d b);
VDIVPD __m256d __mm256_maskz_div_pd( __mmask8 k, __m256d a, __m256d b);
VDIVPD __m128d __mm_mask_div_pd(__m128d s, __mmask8 k, __m128d a, __m128d b);
VDIVPD __m128d __mm_maskz_div_pd( __mmask8 k, __m128d a, __m128d b);
VDIVPD __m512d __mm512_div_round_pd( __m512d a, __m512d b, int);
VDIVPD __m512d __mm512_mask_div_round_pd(__m512d s, __mmask8 k, __m512d a, __m512d b, int);
VDIVPD __m512d __mm512_maskz_div_round_pd( __mmask8 k, __m512d a, __m512d b, int);
VDIVPD __m256d __mm256_div_pd( __m256d a, __m256d b);
DIVPD __m128d __mm_div_pd( __m128d a, __m128d b);

```

### SIMD Floating-Point Exceptions

Overflow, Underflow, Invalid, Divide-by-Zero, Precision, Denormal

### Other Exceptions

VEX-encoded instructions, see Exceptions Type 2.

EVEX-encoded instructions, see Exceptions Type E2.

## DIVPS—Divide Packed Single-Precision Floating-Point Values

Opcode/ Instruction	Op/ En	64/32 bit Mode Support	CPUID Feature Flag	Description
NP OF 5E /r DIVPS xmm1, xmm2/m128	A	V/V	SSE	Divide packed single-precision floating-point values in xmm1 by packed single-precision floating-point values in xmm2/mem.
VEX.NDS.128.OF.WIG 5E /r VDIVPS xmm1, xmm2, xmm3/m128	B	V/V	AVX	Divide packed single-precision floating-point values in xmm2 by packed single-precision floating-point values in xmm3/mem.
VEX.NDS.256.OF.WIG 5E /r VDIVPS ymm1, ymm2, ymm3/m256	B	V/V	AVX	Divide packed single-precision floating-point values in ymm2 by packed single-precision floating-point values in ymm3/mem.
EVEX.NDS.128.OF.W0 5E /r VDIVPS xmm1 {k1}{z}, xmm2, xmm3/m128/m32bcst	C	V/V	AVX512VL AVX512F	Divide packed single-precision floating-point values in xmm2 by packed single-precision floating-point values in xmm3/m128/m32bcst and write results to xmm1 subject to writemask k1.
EVEX.NDS.256.OF.W0 5E /r VDIVPS ymm1 {k1}{z}, ymm2, ymm3/m256/m32bcst	C	V/V	AVX512VL AVX512F	Divide packed single-precision floating-point values in ymm2 by packed single-precision floating-point values in ymm3/m256/m32bcst and write results to ymm1 subject to writemask k1.
EVEX.NDS.512.OF.W0 5E /r VDIVPS zmm1 {k1}{z}, zmm2, zmm3/m512/m32bcst{er}	C	V/V	AVX512F	Divide packed single-precision floating-point values in zmm2 by packed single-precision floating-point values in zmm3/m512/m32bcst and write results to zmm1 subject to writemask k1.

### Instruction Operand Encoding

Op/En	Tuple Type	Operand 1	Operand 2	Operand 3	Operand 4
A	NA	ModRM:reg (r, w)	ModRM:r/m (r)	NA	NA
B	NA	ModRM:reg (w)	VEX.vvvv	ModRM:r/m (r)	NA
C	Full	ModRM:reg (w)	EVEX.vvvv	ModRM:r/m (r)	NA

### Description

Performs a SIMD divide of the four, eight or sixteen packed single-precision floating-point values in the first source operand (the second operand) by the four, eight or sixteen packed single-precision floating-point values in the second source operand (the third operand). Results are written to the destination operand (the first operand).

EVEX encoded versions: The first source operand (the second operand) is a ZMM/YMM/XMM register. The second source operand can be a ZMM/YMM/XMM register, a 512/256/128-bit memory location or a 512/256/128-bit vector broadcasted from a 32-bit memory location. The destination operand is a ZMM/YMM/XMM register conditionally updated with writemask k1.

VEX.256 encoded version: The first source operand is a YMM register. The second source operand can be a YMM register or a 256-bit memory location. The destination operand is a YMM register.

VEX.128 encoded version: The first source operand is a XMM register. The second source operand can be a XMM register or a 128-bit memory location. The destination operand is a XMM register. The upper bits (MAXVL-1:128) of the corresponding ZMM register destination are zeroed.

128-bit Legacy SSE version: The second source can be an XMM register or an 128-bit memory location. The destination is not distinct from the first source XMM register and the upper bits (MAXVL-1:128) of the corresponding ZMM register destination are unmodified.

**Operation****VDIVPS (EVEX encoded versions)**

(KL, VL) = (4, 128), (8, 256), (16, 512)

IF (VL = 512) AND (EVEX.b = 1) AND SRC2 \*is a register\*

```

    THEN
        SET_RM(EVEX.RC);
    ELSE
        SET_RM(MXCSR.RM);
FI;
FOR j ← 0 TO KL-1
    i ← j * 32
    IF k1[j] OR *no writemask*
        THEN
            IF (EVEX.b = 1) AND (SRC2 *is memory*)
                THEN
                    DEST[i+31:i] ← SRC1[i+31:i] / SRC2[31:0]
                ELSE
                    DEST[i+31:i] ← SRC1[i+31:i] / SRC2[i+31:i]
            FI;
        ELSE
            IF *merging-masking*           ; merging-masking
                THEN *DEST[i+31:i] remains unchanged*
            ELSE                             ; zeroing-masking
                DEST[i+31:i] ← 0
            FI
        FI;
ENDFOR
DEST[MAXVL-1:VL] ← 0

```

**VDIVPS (VEX.256 encoded version)**

DEST[31:0] ← SRC1[31:0] / SRC2[31:0]

DEST[63:32] ← SRC1[63:32] / SRC2[63:32]

DEST[95:64] ← SRC1[95:64] / SRC2[95:64]

DEST[127:96] ← SRC1[127:96] / SRC2[127:96]

DEST[159:128] ← SRC1[159:128] / SRC2[159:128]

DEST[191:160] ← SRC1[191:160] / SRC2[191:160]

DEST[223:192] ← SRC1[223:192] / SRC2[223:192]

DEST[255:224] ← SRC1[255:224] / SRC2[255:224].

DEST[MAXVL-1:256] ← 0;

**VDIVPS (VEX.128 encoded version)**

DEST[31:0] ← SRC1[31:0] / SRC2[31:0]

DEST[63:32] ← SRC1[63:32] / SRC2[63:32]

DEST[95:64] ← SRC1[95:64] / SRC2[95:64]

DEST[127:96] ← SRC1[127:96] / SRC2[127:96]

DEST[MAXVL-1:128] ← 0

**DIVPS (128-bit Legacy SSE version)**

DEST[31:0] ← SRC1[31:0] / SRC2[31:0]

DEST[63:32] ← SRC1[63:32] / SRC2[63:32]

DEST[95:64] ← SRC1[95:64] / SRC2[95:64]

DEST[127:96] ← SRC1[127:96] / SRC2[127:96]

DEST[MAXVL-1:128] (Unmodified)

**Intel C/C++ Compiler Intrinsic Equivalent**

VDIVPS \_\_m512 \_\_mm512\_div\_ps(\_\_m512 a, \_\_m512 b);

VDIVPS \_\_m512 \_\_mm512\_mask\_div\_ps(\_\_m512 s, \_\_mmask16 k, \_\_m512 a, \_\_m512 b);

VDIVPS \_\_m512 \_\_mm512\_maskz\_div\_ps(\_\_mmask16 k, \_\_m512 a, \_\_m512 b);

VDIVPD \_\_m256d \_\_mm256\_mask\_div\_pd(\_\_m256d s, \_\_mmask8 k, \_\_m256d a, \_\_m256d b);

VDIVPD \_\_m256d \_\_mm256\_maskz\_div\_pd(\_\_mmask8 k, \_\_m256d a, \_\_m256d b);

VDIVPD \_\_m128d \_\_mm\_mask\_div\_pd(\_\_m128d s, \_\_mmask8 k, \_\_m128d a, \_\_m128d b);

VDIVPD \_\_m128d \_\_mm\_maskz\_div\_pd(\_\_mmask8 k, \_\_m128d a, \_\_m128d b);

VDIVPS \_\_m512 \_\_mm512\_div\_round\_ps(\_\_m512 a, \_\_m512 b, int);

VDIVPS \_\_m512 \_\_mm512\_mask\_div\_round\_ps(\_\_m512 s, \_\_mmask16 k, \_\_m512 a, \_\_m512 b, int);

VDIVPS \_\_m512 \_\_mm512\_maskz\_div\_round\_ps(\_\_mmask16 k, \_\_m512 a, \_\_m512 b, int);

VDIVPS \_\_m256 \_\_mm256\_div\_ps(\_\_m256 a, \_\_m256 b);

DIVPS \_\_m128 \_\_mm\_div\_ps(\_\_m128 a, \_\_m128 b);

**SIMD Floating-Point Exceptions**

Overflow, Underflow, Invalid, Divide-by-Zero, Precision, Denormal

**Other Exceptions**

VEX-encoded instructions, see Exceptions Type 2.

EVEX-encoded instructions, see Exceptions Type E2.

## DIVSD—Divide Scalar Double-Precision Floating-Point Value

Opcode/ Instruction	Op / En	64/32 bit Mode Support	CPUID Feature Flag	Description
F2 0F 5E /r DIVSD xmm1, xmm2/m64	A	V/V	SSE2	Divide low double-precision floating-point value in xmm1 by low double-precision floating-point value in xmm2/m64.
VEX.NDS.LIG.F2.0F.WIG 5E /r VDIVSD xmm1, xmm2, xmm3/m64	B	V/V	AVX	Divide low double-precision floating-point value in xmm2 by low double-precision floating-point value in xmm3/m64.
EVEX.NDS.LIG.F2.0F.W1 5E /r VDIVSD xmm1 {k1}{z}, xmm2, xmm3/m64{er}	C	V/V	AVX512F	Divide low double-precision floating-point value in xmm2 by low double-precision floating-point value in xmm3/m64.

### Instruction Operand Encoding

Op/En	Tuple Type	Operand 1	Operand 2	Operand 3	Operand 4
A	NA	ModRM:reg (r, w)	ModRM:r/m (r)	NA	NA
B	NA	ModRM:reg (w)	VEX.vvvv	ModRM:r/m (r)	NA
C	Tuple1 Scalar	ModRM:reg (w)	EVEX.vvvv	ModRM:r/m (r)	NA

### Description

Divides the low double-precision floating-point value in the first source operand by the low double-precision floating-point value in the second source operand, and stores the double-precision floating-point result in the destination operand. The second source operand can be an XMM register or a 64-bit memory location. The first source and destination are XMM registers.

128-bit Legacy SSE version: The first source operand and the destination operand are the same. Bits (MAXVL-1:64) of the corresponding ZMM destination register remain unchanged.

VEX.128 encoded version: The first source operand is an xmm register encoded by VEX.vvvv. The quadword at bits 127:64 of the destination operand is copied from the corresponding quadword of the first source operand. Bits (MAXVL-1:128) of the destination register are zeroed.

EVEX.128 encoded version: The first source operand is an xmm register encoded by EVEX.vvvv. The quadword element of the destination operand at bits 127:64 are copied from the first source operand. Bits (MAXVL-1:128) of the destination register are zeroed.

EVEX version: The low quadword element of the destination is updated according to the writemask.

Software should ensure VDIVSD is encoded with VEX.L=0. Encoding VDIVSD with VEX.L=1 may encounter unpredictable behavior across different processor generations.

**Operation****VDIVSD (EVEX encoded version)**

```

IF (EVEX.b = 1) AND SRC2 *is a register*
    THEN
        SET_RM(EVEX.RC);
    ELSE
        SET_RM(MXCSR.RM);
FI;
IF k1[0] or *no writemask*
    THEN DEST[63:0] ← SRC1[63:0] / SRC2[63:0]
    ELSE
        IF *merging-masking* ; merging-masking
            THEN *DEST[63:0] remains unchanged*
            ELSE ; zeroing-masking
                THEN DEST[63:0] ← 0
        FI;
FI;
DEST[127:64] ← SRC1[127:64]
DEST[MAXVL-1:128] ← 0

```

**VDIVSD (VEX.128 encoded version)**

```

DEST[63:0] ← SRC1[63:0] / SRC2[63:0]
DEST[127:64] ← SRC1[127:64]
DEST[MAXVL-1:128] ← 0

```

**DIVSD (128-bit Legacy SSE version)**

```

DEST[63:0] ← DEST[63:0] / SRC[63:0]
DEST[MAXVL-1:64] (Unmodified)

```

**Intel C/C++ Compiler Intrinsic Equivalent**

```

VDIVSD __m128d _mm_mask_div_sd(__m128d s, __mmask8 k, __m128d a, __m128d b);
VDIVSD __m128d _mm_maskz_div_sd(__mmask8 k, __m128d a, __m128d b);
VDIVSD __m128d _mm_div_round_sd(__m128d a, __m128d b, int);
VDIVSD __m128d _mm_mask_div_round_sd(__m128d s, __mmask8 k, __m128d a, __m128d b, int);
VDIVSD __m128d _mm_maskz_div_round_sd(__mmask8 k, __m128d a, __m128d b, int);
DIVSD __m128d _mm_div_sd(__m128d a, __m128d b);

```

**SIMD Floating-Point Exceptions**

Overflow, Underflow, Invalid, Divide-by-Zero, Precision, Denormal

**Other Exceptions**

VEX-encoded instructions, see Exceptions Type 3.

EVEX-encoded instructions, see Exceptions Type E3.



## DIVSS—Divide Scalar Single-Precision Floating-Point Values

Opcode/ Instruction	Op / En	64/32 bit Mode Support	CPUID Feature Flag	Description
F3 0F 5E /r DIVSS xmm1, xmm2/m32	A	V/V	SSE	Divide low single-precision floating-point value in xmm1 by low single-precision floating-point value in xmm2/m32.
VEX.NDS.LIG.F3.0F.WIG 5E /r VDIVSS xmm1, xmm2, xmm3/m32	B	V/V	AVX	Divide low single-precision floating-point value in xmm2 by low single-precision floating-point value in xmm3/m32.
EVEX.NDS.LIG.F3.0F.W0 5E /r VDIVSS xmm1 {k1}{z}, xmm2, xmm3/m32{er}	C	V/V	AVX512F	Divide low single-precision floating-point value in xmm2 by low single-precision floating-point value in xmm3/m32.

### Instruction Operand Encoding

Op/En	Tuple Type	Operand 1	Operand 2	Operand 3	Operand 4
A	NA	ModRM:reg (r, w)	ModRM:r/m (r)	NA	NA
B	NA	ModRM:reg (w)	VEX.vvvv	ModRM:r/m (r)	NA
C	Tuple1 Scalar	ModRM:reg (w)	EVEX.vvvv	ModRM:r/m (r)	NA

### Description

Divides the low single-precision floating-point value in the first source operand by the low single-precision floating-point value in the second source operand, and stores the single-precision floating-point result in the destination operand. The second source operand can be an XMM register or a 32-bit memory location.

128-bit Legacy SSE version: The first source operand and the destination operand are the same. Bits (MAXVL-1:32) of the corresponding YMM destination register remain unchanged.

VEX.128 encoded version: The first source operand is an xmm register encoded by VEX.vvvv. The three high-order doublewords of the destination operand are copied from the first source operand. Bits (MAXVL-1:128) of the destination register are zeroed.

EVEX.128 encoded version: The first source operand is an xmm register encoded by EVEX.vvvv. The doubleword elements of the destination operand at bits 127:32 are copied from the first source operand. Bits (MAXVL-1:128) of the destination register are zeroed.

EVEX version: The low doubleword element of the destination is updated according to the writemask.

Software should ensure VDIVSS is encoded with VEX.L=0. Encoding VDIVSS with VEX.L=1 may encounter unpredictable behavior across different processor generations.

**Operation****VDIVSS (EVEX encoded version)**

```

IF (EVEX.b = 1) AND SRC2 *is a register*
    THEN
        SET_RM(EVEX.RC);
    ELSE
        SET_RM(MXCSR.RM);
FI;
IF k1[0] or *no writemask*
    THEN DEST[31:0] ← SRC1[31:0] / SRC2[31:0]
    ELSE
        IF *merging-masking* ; merging-masking
            THEN *DEST[31:0] remains unchanged*
            ELSE ; zeroing-masking
                THEN DEST[31:0] ← 0
        FI;
FI;
DEST[127:32] ← SRC1[127:32]
DEST[MAXVL-1:128] ← 0

```

**VDIVSS (VEX.128 encoded version)**

```

DEST[31:0] ← SRC1[31:0] / SRC2[31:0]
DEST[127:32] ← SRC1[127:32]
DEST[MAXVL-1:128] ← 0

```

**DIVSS (128-bit Legacy SSE version)**

```

DEST[31:0] ← DEST[31:0] / SRC[31:0]
DEST[MAXVL-1:32] (Unmodified)

```

**Intel C/C++ Compiler Intrinsic Equivalent**

```

VDIVSS __m128 __mm_mask_div_ss(__m128 s, __mmask8 k, __m128 a, __m128 b);
VDIVSS __m128 __mm_maskz_div_ss( __mmask8 k, __m128 a, __m128 b);
VDIVSS __m128 __mm_div_round_ss( __m128 a, __m128 b, int);
VDIVSS __m128 __mm_mask_div_round_ss(__m128 s, __mmask8 k, __m128 a, __m128 b, int);
VDIVSS __m128 __mm_maskz_div_round_ss( __mmask8 k, __m128 a, __m128 b, int);
DIVSS __m128 __mm_div_ss(__m128 a, __m128 b);

```

**SIMD Floating-Point Exceptions**

Overflow, Underflow, Invalid, Divide-by-Zero, Precision, Denormal

**Other Exceptions**

VEX-encoded instructions, see Exceptions Type 3.

EVEX-encoded instructions, see Exceptions Type E3.

## DPPD – Dot Product of Packed Double Precision Floating-Point Values

Opcode/ Instruction	Op/ En	64/32-bit Mode	CPUID Feature Flag	Description
66 0F 3A 41 /r ib DPPD <i>xmm1</i> , <i>xmm2/m128</i> , <i>imm8</i>	RMI	V/V	SSE4_1	Selectively multiply packed DP floating-point values from <i>xmm1</i> with packed DP floating-point values from <i>xmm2</i> , add and selectively store the packed DP floating-point values to <i>xmm1</i> .
VEX.NDS.128.66.0F3A.WIG 41 /r ib VDPPD <i>xmm1</i> , <i>xmm2</i> , <i>xmm3/m128</i> , <i>imm8</i>	RVMI	V/V	AVX	Selectively multiply packed DP floating-point values from <i>xmm2</i> with packed DP floating-point values from <i>xmm3</i> , add and selectively store the packed DP floating-point values to <i>xmm1</i> .

### Instruction Operand Encoding

Op/En	Operand 1	Operand 2	Operand 3	Operand 4
RMI	ModRM:reg (r, w)	ModRM:r/m (r)	imm8	NA
RVMI	ModRM:reg (w)	VEX.vvvv (r)	ModRM:r/m (r)	imm8

### Description

Conditionally multiplies the packed double-precision floating-point values in the destination operand (first operand) with the packed double-precision floating-point values in the source (second operand) depending on a mask extracted from bits [5:4] of the immediate operand (third operand). If a condition mask bit is zero, the corresponding multiplication is replaced by a value of 0.0 in the manner described by Section 12.8.4 of *Intel® 64 and IA-32 Architectures Software Developer's Manual, Volume 1*.

The two resulting double-precision values are summed into an intermediate result. The intermediate result is conditionally broadcasted to the destination using a broadcast mask specified by bits [1:0] of the immediate byte.

If a broadcast mask bit is "1", the intermediate result is copied to the corresponding qword element in the destination operand. If a broadcast mask bit is zero, the corresponding element in the destination is set to zero.

DPPD follows the NaN forwarding rules stated in the Software Developer's Manual, vol. 1, table 4.7. These rules do not cover horizontal prioritization of NaNs. Horizontal propagation of NaNs to the destination and the positioning of those NaNs in the destination is implementation dependent. NaNs on the input sources or computationally generated NaNs will have at least one NaN propagated to the destination.

128-bit Legacy SSE version: The second source can be an XMM register or a 128-bit memory location. The destination is not distinct from the first source XMM register and the upper bits (MAXVL-1:128) of the corresponding YMM register destination are unmodified.

VEX.128 encoded version: the first source operand is an XMM register or 128-bit memory location. The destination operand is an XMM register. The upper bits (MAXVL-1:128) of the corresponding YMM register destination are zeroed.

If VDPPD is encoded with VEX.L= 1, an attempt to execute the instruction encoded with VEX.L= 1 will cause an #UD exception.

## Operation

### DP\_primitive (SRC1, SRC2)

```

IF (imm8[4] = 1)
    THEN Temp1[63:0] ← DEST[63:0] * SRC[63:0]; // update SIMD exception flags
    ELSE Temp1[63:0] ← +0.0; FI;
IF (imm8[5] = 1)
    THEN Temp1[127:64] ← DEST[127:64] * SRC[127:64]; // update SIMD exception flags
    ELSE Temp1[127:64] ← +0.0; FI;
/* if unmasked exception reported, execute exception handler*/

```

```

Temp2[63:0] ← Temp1[63:0] + Temp1[127:64]; // update SIMD exception flags
/* if unmasked exception reported, execute exception handler*/

```

```

IF (imm8[0] = 1)
    THEN DEST[63:0] ← Temp2[63:0];
    ELSE DEST[63:0] ← +0.0; FI;
IF (imm8[1] = 1)
    THEN DEST[127:64] ← Temp2[63:0];
    ELSE DEST[127:64] ← +0.0; FI;

```

### DPPD (128-bit Legacy SSE version)

```

DEST[127:0] ← DP_Primitive(SRC1[127:0], SRC2[127:0]);
DEST[MAXVL-1:128] (Unmodified)

```

### VDPPD (VEX.128 encoded version)

```

DEST[127:0] ← DP_Primitive(SRC1[127:0], SRC2[127:0]);
DEST[MAXVL-1:128] ← 0

```

## Flags Affected

None

## Intel C/C++ Compiler Intrinsic Equivalent

DPPD: `__m128d _mm_dp_pd ( __m128d a, __m128d b, const int mask);`

## SIMD Floating-Point Exceptions

Overflow, Underflow, Invalid, Precision, Denormal

Exceptions are determined separately for each add and multiply operation. Unmasked exceptions will leave the destination untouched.

## Other Exceptions

See Exceptions Type 2; additionally

#UD If VEX.L= 1.

## DPPS — Dot Product of Packed Single Precision Floating-Point Values

Opcode/ Instruction	Op/ En	64/32-bit Mode	CPUID Feature Flag	Description
66 0F 3A 40 /r ib DPPS <i>xmm1</i> , <i>xmm2/m128</i> , <i>imm8</i>	RMI	V/V	SSE4_1	Selectively multiply packed SP floating-point values from <i>xmm1</i> with packed SP floating-point values from <i>xmm2</i> , add and selectively store the packed SP floating-point values or zero values to <i>xmm1</i> .
VEX.NDS.128.66.0F3A.WIG 40 /r ib VDPPS <i>xmm1</i> , <i>xmm2</i> , <i>xmm3/m128</i> , <i>imm8</i>	RVMI	V/V	AVX	Multiply packed SP floating point values from <i>xmm1</i> with packed SP floating point values from <i>xmm2/mem</i> selectively add and store to <i>xmm1</i> .
VEX.NDS.256.66.0F3A.WIG 40 /r ib VDPPS <i>ymm1</i> , <i>ymm2</i> , <i>ymm3/m256</i> , <i>imm8</i>	RVMI	V/V	AVX	Multiply packed single-precision floating-point values from <i>ymm2</i> with packed SP floating point values from <i>ymm3/mem</i> , selectively add pairs of elements and store to <i>ymm1</i> .

### Instruction Operand Encoding

Op/En	Operand 1	Operand 2	Operand 3	Operand 4
RMI	ModRM:reg (r, w)	ModRM:r/m (r)	imm8	NA
RVMI	ModRM:reg (w)	VEX.vvvv (r)	ModRM:r/m (r)	imm8

### Description

Conditionally multiplies the packed single precision floating-point values in the destination operand (first operand) with the packed single-precision floats in the source (second operand) depending on a mask extracted from the high 4 bits of the immediate byte (third operand). If a condition mask bit in `Imm8[7:4]` is zero, the corresponding multiplication is replaced by a value of 0.0 in the manner described by Section 12.8.4 of *Intel® 64 and IA-32 Architectures Software Developer's Manual, Volume 1*.

The four resulting single-precision values are summed into an intermediate result. The intermediate result is conditionally broadcasted to the destination using a broadcast mask specified by bits `[3:0]` of the immediate byte.

If a broadcast mask bit is "1", the intermediate result is copied to the corresponding dword element in the destination operand. If a broadcast mask bit is zero, the corresponding element in the destination is set to zero.

DPPS follows the NaN forwarding rules stated in the Software Developer's Manual, vol. 1, table 4.7. These rules do not cover horizontal prioritization of NaNs. Horizontal propagation of NaNs to the destination and the positioning of those NaNs in the destination is implementation dependent. NaNs on the input sources or computationally generated NaNs will have at least one NaN propagated to the destination.

128-bit Legacy SSE version: The second source can be an XMM register or a 128-bit memory location. The destination is not distinct from the first source XMM register and the upper bits (`MAXVL-1:128`) of the corresponding YMM register destination are unmodified.

VEX.128 encoded version: the first source operand is an XMM register or 128-bit memory location. The destination operand is an XMM register. The upper bits (`MAXVL-1:128`) of the corresponding YMM register destination are zeroed.

VEX.256 encoded version: The first source operand is a YMM register. The second source operand can be a YMM register or a 256-bit memory location. The destination operand is a YMM register.

**Operation****DP\_primitive (SRC1, SRC2)**

```

IF (imm8[4] = 1)
    THEN Temp1[31:0] ← DEST[31:0] * SRC[31:0]; // update SIMD exception flags
    ELSE Temp1[31:0] ← +0.0; FI;
IF (imm8[5] = 1)
    THEN Temp1[63:32] ← DEST[63:32] * SRC[63:32]; // update SIMD exception flags
    ELSE Temp1[63:32] ← +0.0; FI;
IF (imm8[6] = 1)
    THEN Temp1[95:64] ← DEST[95:64] * SRC[95:64]; // update SIMD exception flags
    ELSE Temp1[95:64] ← +0.0; FI;
IF (imm8[7] = 1)
    THEN Temp1[127:96] ← DEST[127:96] * SRC[127:96]; // update SIMD exception flags
    ELSE Temp1[127:96] ← +0.0; FI;

Temp2[31:0] ← Temp1[31:0] + Temp1[63:32]; // update SIMD exception flags
/* if unmasked exception reported, execute exception handler*/
Temp3[31:0] ← Temp1[95:64] + Temp1[127:96]; // update SIMD exception flags
/* if unmasked exception reported, execute exception handler*/
Temp4[31:0] ← Temp2[31:0] + Temp3[31:0]; // update SIMD exception flags
/* if unmasked exception reported, execute exception handler*/

```

```

IF (imm8[0] = 1)
    THEN DEST[31:0] ← Temp4[31:0];
    ELSE DEST[31:0] ← +0.0; FI;
IF (imm8[1] = 1)
    THEN DEST[63:32] ← Temp4[31:0];
    ELSE DEST[63:32] ← +0.0; FI;
IF (imm8[2] = 1)
    THEN DEST[95:64] ← Temp4[31:0];
    ELSE DEST[95:64] ← +0.0; FI;
IF (imm8[3] = 1)
    THEN DEST[127:96] ← Temp4[31:0];
    ELSE DEST[127:96] ← +0.0; FI;

```

**DPPS (128-bit Legacy SSE version)**

```

DEST[127:0] ← DP_Primitive(SRC1[127:0], SRC2[127:0]);
DEST[MAXVL-1:128] (Unmodified)

```

**VDPPS (VEX.128 encoded version)**

```

DEST[127:0] ← DP_Primitive(SRC1[127:0], SRC2[127:0]);
DEST[MAXVL-1:128] ← 0

```

**VDPPS (VEX.256 encoded version)**

```

DEST[127:0] ← DP_Primitive(SRC1[127:0], SRC2[127:0]);
DEST[255:128] ← DP_Primitive(SRC1[255:128], SRC2[255:128]);

```

**Flags Affected**

None

### Intel C/C++ Compiler Intrinsic Equivalent

(V)DPPS: `__m128 _mm_dp_ps (__m128 a, __m128 b, const int mask);`

VDPPS: `__m256 _mm256_dp_ps (__m256 a, __m256 b, const int mask);`

### SIMD Floating-Point Exceptions

Overflow, Underflow, Invalid, Precision, Denormal

Exceptions are determined separately for each add and multiply operation, in the order of their execution. Unmasked exceptions will leave the destination operands unchanged.

### Other Exceptions

See Exceptions Type 2.

## EMMS—Empty MMX Technology State

Opcode	Instruction	Op/En	64-Bit Mode	Compat/Leg Mode	Description
NP OF 77	EMMS	Z0	Valid	Valid	Set the x87 FPU tag word to empty.

### Instruction Operand Encoding

Op/En	Operand 1	Operand 2	Operand 3	Operand 4
Z0	NA	NA	NA	NA

### Description

Sets the values of all the tags in the x87 FPU tag word to empty (all 1s). This operation marks the x87 FPU data registers (which are aliased to the MMX technology registers) as available for use by x87 FPU floating-point instructions. (See Figure 8-7 in the *Intel® 64 and IA-32 Architectures Software Developer's Manual, Volume 1*, for the format of the x87 FPU tag word.) All other MMX instructions (other than the EMMS instruction) set all the tags in x87 FPU tag word to valid (all 0s).

The EMMS instruction must be used to clear the MMX technology state at the end of all MMX technology procedures or subroutines and before calling other procedures or subroutines that may execute x87 floating-point instructions. If a floating-point instruction loads one of the registers in the x87 FPU data register stack before the x87 FPU tag word has been reset by the EMMS instruction, an x87 floating-point register stack overflow can occur that will result in an x87 floating-point exception or incorrect result.

EMMS operation is the same in non-64-bit modes and 64-bit mode.

### Operation

```
x87FPUTagWord ← FFFFH;
```

### Intel C/C++ Compiler Intrinsic Equivalent

```
void _mm_empty()
```

### Flags Affected

None

### Protected Mode Exceptions

#UD If CR0.EM[bit 2] = 1.  
 #NM If CR0.TS[bit 3] = 1.  
 #MF If there is a pending FPU exception.  
 #UD If the LOCK prefix is used.

### Real-Address Mode Exceptions

Same exceptions as in protected mode.

### Virtual-8086 Mode Exceptions

Same exceptions as in protected mode.

### Compatibility Mode Exceptions

Same exceptions as in protected mode.

### 64-Bit Mode Exceptions

Same exceptions as in protected mode.



## ENTER—Make Stack Frame for Procedure Parameters

Opcode	Instruction	Op/En	64-Bit Mode	Compat/Leg Mode	Description
C8 iw 00	ENTER <i>imm16</i> , 0	II	Valid	Valid	Create a stack frame for a procedure.
C8 iw 01	ENTER <i>imm16</i> , 1	II	Valid	Valid	Create a stack frame with a nested pointer for a procedure.
C8 iw ib	ENTER <i>imm16</i> , <i>imm8</i>	II	Valid	Valid	Create a stack frame with nested pointers for a procedure.

### Instruction Operand Encoding

Op/En	Operand 1	Operand 2	Operand 3	Operand 4
II	iw	imm8	NA	NA

### Description

Creates a stack frame (comprising of space for dynamic storage and 1-32 frame pointer storage) for a procedure. The first operand (*imm16*) specifies the size of the dynamic storage in the stack frame (that is, the number of bytes of dynamically allocated on the stack for the procedure). The second operand (*imm8*) gives the lexical nesting level (0 to 31) of the procedure. The nesting level (*imm8 mod 32*) and the *OperandSize* attribute determine the size in bytes of the storage space for frame pointers.

The nesting level determines the number of frame pointers that are copied into the “display area” of the new stack frame from the preceding frame. The default size of the frame pointer is the *StackAddrSize* attribute, but can be overridden using the 66H prefix. Thus, the *OperandSize* attribute determines the size of each frame pointer that will be copied into the stack frame and the data being transferred from SP/ESP/RSP register into the BP/EBP/RBP register.

The ENTER and companion LEAVE instructions are provided to support block structured languages. The ENTER instruction (when used) is typically the first instruction in a procedure and is used to set up a new stack frame for a procedure. The LEAVE instruction is then used at the end of the procedure (just before the RET instruction) to release the stack frame.

If the nesting level is 0, the processor pushes the frame pointer from the BP/EBP/RBP register onto the stack, copies the current stack pointer from the SP/ESP/RSP register into the BP/EBP/RBP register, and loads the SP/ESP/RSP register with the current stack-pointer value minus the value in the size operand. For nesting levels of 1 or greater, the processor pushes additional frame pointers on the stack before adjusting the stack pointer. These additional frame pointers provide the called procedure with access points to other nested frames on the stack. See “Procedure Calls for Block-Structured Languages” in Chapter 6 of the *Intel® 64 and IA-32 Architectures Software Developer’s Manual, Volume 1*, for more information about the actions of the ENTER instruction.

The ENTER instruction causes a page fault whenever a write using the final value of the stack pointer (within the current stack segment) would do so.

In 64-bit mode, default operation size is 64 bits; 32-bit operation size cannot be encoded. Use of 66H prefix changes frame pointer operand size to 16 bits.

When the 66H prefix is used and causing the *OperandSize* attribute to be less than the *StackAddrSize*, software is responsible for the following:

- The companion LEAVE instruction must also use the 66H prefix,
- The value in the RBP/EBP register prior to executing “66H ENTER” must be within the same 16KByte region of the current stack pointer (RSP/ESP), such that the value of RBP/EBP after “66H ENTER” remains a valid address in the stack. This ensures “66H LEAVE” can restore 16-bits of data from the stack.

**Operation**

```

AllocSize ← imm16;
NestingLevel ← imm8 MOD 32;
IF (OperandSize = 64)
  THEN
    Push(RBP); (* RSP decrements by 8 *)
    FrameTemp ← RSP;
  ELSE IF OperandSize = 32
    THEN
      Push(EBP); (* (E)SP decrements by 4 *)
      FrameTemp ← ESP; FI;
  ELSE (* OperandSize = 16 *)
    Push(BP); (* RSP or (E)SP decrements by 2 *)
    FrameTemp ← SP;
FI;

IF NestingLevel = 0
  THEN GOTO CONTINUE;
FI;

IF (NestingLevel > 1)
  THEN FOR i ← 1 to (NestingLevel - 1)
    DO
      IF (OperandSize = 64)
        THEN
          RBP ← RBP - 8;
          Push([RBP]); (* Quadword push *)
        ELSE IF OperandSize = 32
          THEN
            IF StackSize = 32
              EBP ← EBP - 4;
              Push([EBP]); (* Doubleword push *)
            ELSE (* StackSize = 16 *)
              BP ← BP - 4;
              Push([BP]); (* Doubleword push *)
            FI;
          FI;
        ELSE (* OperandSize = 16 *)
          IF StackSize = 32
            THEN
              EBP ← EBP - 2;
              Push([EBP]); (* Word push *)
            ELSE (* StackSize = 16 *)
              BP ← BP - 2;
              Push([BP]); (* Word push *)
            FI;
          FI;
        FI;
      FI;
    OD;
  FI;

IF (OperandSize = 64) (* nestinglevel 1 *)
  THEN
    Push(FrameTemp); (* Quadword push and RSP decrements by 8 *)
  ELSE IF OperandSize = 32

```

```

    THEN
        Push(FrameTemp); FI; (* Doubleword push and (E)SP decrements by 4 *)
    ELSE (* OperandSize = 16 *)
        Push(FrameTemp); (* Word push and RSP|ESP|SP decrements by 2 *)
FI;

CONTINUE:
IF 64-Bit Mode (StackSize = 64)
    THEN
        RBP ← FrameTemp;
        RSP ← RSP – AllocSize;
    ELSE IF OperandSize = 32
        THEN
            EBP ← FrameTemp;
            ESP ← ESP – AllocSize; FI;
    ELSE (* OperandSize = 16 *)
        BP ← FrameTemp[15:1]; (* Bits 16 and above of applicable RBP/EBP are unmodified *)
        SP ← SP – AllocSize;
FI;

END;

```

### Flags Affected

None.

### Protected Mode Exceptions

#SS(0) If the new value of the SP or ESP register is outside the stack segment limit.  
 #PF(fault-code) If a page fault occurs or if a write using the final value of the stack pointer (within the current stack segment) would cause a page fault.  
 #UD If the LOCK prefix is used.

### Real-Address Mode Exceptions

#SS If the new value of the SP or ESP register is outside the stack segment limit.  
 #UD If the LOCK prefix is used.

### Virtual-8086 Mode Exceptions

#SS(0) If the new value of the SP or ESP register is outside the stack segment limit.  
 #PF(fault-code) If a page fault occurs or if a write using the final value of the stack pointer (within the current stack segment) would cause a page fault.  
 #UD If the LOCK prefix is used.

### Compatibility Mode Exceptions

Same exceptions as in protected mode.

### 64-Bit Mode Exceptions

#SS(0) If the stack address is in a non-canonical form.  
 #PF(fault-code) If a page fault occurs or if a write using the final value of the stack pointer (within the current stack segment) would cause a page fault.  
 #UD If the LOCK prefix is used.

## EXTRACTPS—Extract Packed Floating-Point Values

Opcode/ Instruction	Op/ En	64/32 bit Mode Support	CPUID Feature Flag	Description
66 0F 3A 17 /r ib EXTRACTPS reg/m32, xmm1, imm8	A	VV	SSE4_1	Extract one single-precision floating-point value from xmm1 at the offset specified by imm8 and store the result in reg or m32. Zero extend the results in 64-bit register if applicable.
VEX.128.66.0F3A.WIG 17 /r ib VEXTRACTPS reg/m32, xmm1, imm8	A	V/V	AVX	Extract one single-precision floating-point value from xmm1 at the offset specified by imm8 and store the result in reg or m32. Zero extend the results in 64-bit register if applicable.
EVEX.128.66.0F3A.WIG 17 /r ib VEXTRACTPS reg/m32, xmm1, imm8	B	V/V	AVX512F	Extract one single-precision floating-point value from xmm1 at the offset specified by imm8 and store the result in reg or m32. Zero extend the results in 64-bit register if applicable.

### Instruction Operand Encoding

Op/En	Tuple Type	Operand 1	Operand 2	Operand 3	Operand 4
A	NA	ModRM:r/m (w)	ModRM:reg (r)	Imm8	NA
B	Tuple1 Scalar	ModRM:r/m (w)	ModRM:reg (r)	Imm8	NA

### Description

Extracts a single-precision floating-point value from the source operand (second operand) at the 32-bit offset specified from imm8. Immediate bits higher than the most significant offset for the vector length are ignored.

The extracted single-precision floating-point value is stored in the low 32-bits of the destination operand

In 64-bit mode, destination register operand has default operand size of 64 bits. The upper 32-bits of the register are filled with zero. REX.W is ignored.

VEX.128 and EVEX encoded version: When VEX.W1 or EVEX.W1 form is used in 64-bit mode with a general purpose register (GPR) as a destination operand, the packed single quantity is zero extended to 64 bits.

VEX.vvvv/EVEX.vvvv is reserved and must be 1111b otherwise instructions will #UD.

128-bit Legacy SSE version: When a REX.W prefix is used in 64-bit mode with a general purpose register (GPR) as a destination operand, the packed single quantity is zero extended to 64 bits.

The source register is an XMM register. Imm8[1:0] determine the starting DWORD offset from which to extract the 32-bit floating-point value.

If VEXTRACTPS is encoded with VEX.L= 1, an attempt to execute the instruction encoded with VEX.L= 1 will cause an #UD exception.

### Operation

#### VEXTRACTPS (EVEX and VEX.128 encoded version)

SRC\_OFFSET ← IMM8[1:0]

IF (64-Bit Mode and DEST is register)

DEST[31:0] ← (SRC[127:0] >> (SRC\_OFFSET\*32)) AND 0FFFFFFFh

DEST[63:32] ← 0

ELSE

DEST[31:0] ← (SRC[127:0] >> (SRC\_OFFSET\*32)) AND 0FFFFFFFh

FI

**EXTRACTPS (128-bit Legacy SSE version)**

SRC\_OFFSET ← IMM8[1:0]

IF (64-Bit Mode and DEST is register)

DEST[31:0] ← (SRC[127:0] >> (SRC\_OFFSET\*32)) AND 0FFFFFFFh

DEST[63:32] ← 0

ELSE

DEST[31:0] ← (SRC[127:0] >> (SRC\_OFFSET\*32)) AND 0FFFFFFFh

FI

**Intel C/C++ Compiler Intrinsic Equivalent**

EXTRACTPS int \_mm\_extract\_ps (\_\_m128 a, const int idx);

**SIMD Floating-Point Exceptions**

None

**Other Exceptions**

VEX-encoded instructions, see Exceptions Type 5; Additionally

EVEX-encoded instructions, see Exceptions Type E9NF.

#UD IF VEX.L = 0.

#UD If VEX.vvvv != 1111B or EVEX.vvvv != 1111B.

## F2XM1—Compute $2^x-1$

Opcode	Instruction	64-Bit Mode	Compat/ Leg Mode	Description
D9 F0	F2XM1	Valid	Valid	Replace ST(0) with $(2^{\text{ST}(0)} - 1)$ .

### Description

Computes the exponential value of 2 to the power of the source operand minus 1. The source operand is located in register ST(0) and the result is also stored in ST(0). The value of the source operand must lie in the range  $-1.0$  to  $+1.0$ . If the source value is outside this range, the result is undefined.

The following table shows the results obtained when computing the exponential value of various classes of numbers, assuming that neither overflow nor underflow occurs.

**Table 3-16. Results Obtained from F2XM1**

ST(0) SRC	ST(0) DEST
$-1.0$ to $-0$	$-0.5$ to $-0$
$-0$	$-0$
$+0$	$+0$
$+0$ to $+1.0$	$+0$ to $1.0$

Values other than 2 can be exponentiated using the following formula:

$$x^y \leftarrow 2^{(y * \log_2 x)}$$

This instruction's operation is the same in non-64-bit modes and 64-bit mode.

### Operation

$\text{ST}(0) \leftarrow (2^{\text{ST}(0)} - 1)$ ;

### FPU Flags Affected

C1 Set to 0 if stack underflow occurred.  
Set if result was rounded up; cleared otherwise.

C0, C2, C3 Undefined.

### Floating-Point Exceptions

#IS Stack underflow occurred.

#IA Source operand is an SNaN value or unsupported format.

#D Source is a denormal value.

#U Result is too small for destination format.

#P Value cannot be represented exactly in destination format.

### Protected Mode Exceptions

#NM CR0.EM[bit 2] or CR0.TS[bit 3] = 1.

#UD If the LOCK prefix is used.

### Real-Address Mode Exceptions

Same exceptions as in protected mode.

### Virtual-8086 Mode Exceptions

Same exceptions as in protected mode.

**Compatibility Mode Exceptions**

Same exceptions as in protected mode.

**64-Bit Mode Exceptions**

Same exceptions as in protected mode.

## FABS—Absolute Value

Opcode	Instruction	64-Bit Mode	Compat/ Leg Mode	Description
D9 E1	FABS	Valid	Valid	Replace ST with its absolute value.

### Description

Clears the sign bit of ST(0) to create the absolute value of the operand. The following table shows the results obtained when creating the absolute value of various classes of numbers.

**Table 3-17. Results Obtained from FABS**

ST(0) SRC	ST(0) DEST
$-\infty$	$+\infty$
-F	+F
-0	+0
+0	+0
+F	+F
$+\infty$	$+\infty$
NaN	NaN

#### NOTES:

F Means finite floating-point value.

This instruction's operation is the same in non-64-bit modes and 64-bit mode.

### Operation

$ST(0) \leftarrow |ST(0)|;$

### FPU Flags Affected

C1 Set to 0.  
C0, C2, C3 Undefined.

### Floating-Point Exceptions

#IS Stack underflow occurred.

### Protected Mode Exceptions

#NM CR0.EM[bit 2] or CR0.TS[bit 3] = 1.  
#UD If the LOCK prefix is used.

### Real-Address Mode Exceptions

Same exceptions as in protected mode.

### Virtual-8086 Mode Exceptions

Same exceptions as in protected mode.

### Compatibility Mode Exceptions

Same exceptions as in protected mode.

### 64-Bit Mode Exceptions

Same exceptions as in protected mode.



## FADD/FADDP/FIADD—Add

Opcode	Instruction	64-Bit Mode	Compat/Leg Mode	Description
D8 /0	FADD <i>m32fp</i>	Valid	Valid	Add <i>m32fp</i> to ST(0) and store result in ST(0).
DC /0	FADD <i>m64fp</i>	Valid	Valid	Add <i>m64fp</i> to ST(0) and store result in ST(0).
D8 C0+i	FADD ST(0), ST(i)	Valid	Valid	Add ST(0) to ST(i) and store result in ST(0).
DC C0+i	FADD ST(i), ST(0)	Valid	Valid	Add ST(i) to ST(0) and store result in ST(i).
DE C0+i	FADDP ST(i), ST(0)	Valid	Valid	Add ST(0) to ST(i), store result in ST(i), and pop the register stack.
DE C1	FADDP	Valid	Valid	Add ST(0) to ST(1), store result in ST(1), and pop the register stack.
DA /0	FIADD <i>m32int</i>	Valid	Valid	Add <i>m32int</i> to ST(0) and store result in ST(0).
DE /0	FIADD <i>m16int</i>	Valid	Valid	Add <i>m16int</i> to ST(0) and store result in ST(0).

### Description

Adds the destination and source operands and stores the sum in the destination location. The destination operand is always an FPU register; the source operand can be a register or a memory location. Source operands in memory can be in single-precision or double-precision floating-point format or in word or doubleword integer format.

The no-operand version of the instruction adds the contents of the ST(0) register to the ST(1) register. The one-operand version adds the contents of a memory location (either a floating-point or an integer value) to the contents of the ST(0) register. The two-operand version, adds the contents of the ST(0) register to the ST(i) register or vice versa. The value in ST(0) can be doubled by coding:

```
FADD ST(0), ST(0);
```

The FADDP instructions perform the additional operation of popping the FPU register stack after storing the result. To pop the register stack, the processor marks the ST(0) register as empty and increments the stack pointer (TOP) by 1. (The no-operand version of the floating-point add instructions always results in the register stack being popped. In some assemblers, the mnemonic for this instruction is FADD rather than FADDP.)

The FIADD instructions convert an integer source operand to double extended-precision floating-point format before performing the addition.

The table on the following page shows the results obtained when adding various classes of numbers, assuming that neither overflow nor underflow occurs.

When the sum of two operands with opposite signs is 0, the result is +0, except for the round toward  $-\infty$  mode, in which case the result is  $-0$ . When the source operand is an integer 0, it is treated as a +0.

When both operand are infinities of the same sign, the result is  $\infty$  of the expected sign. If both operands are infinities of opposite signs, an invalid-operation exception is generated. See Table 3-18.

Table 3-18. FADD/FADDP/FIADD Results

		DEST						
		$-\infty$	$-F$	$-0$	$+0$	$+F$	$+\infty$	
SRC	$-\infty$	$-\infty$	$-\infty$	$-\infty$	$-\infty$	$-\infty$	*	NaN
	$-F$ or $-I$	$-\infty$	$-F$	SRC	SRC	$\pm F$ or $\pm 0$	$+\infty$	NaN
	$-0$	$-\infty$	DEST	$-0$	$\pm 0$	DEST	$+\infty$	NaN
	$+0$	$-\infty$	DEST	$\pm 0$	$+0$	DEST	$+\infty$	NaN
	$+F$ or $+I$	$-\infty$	$\pm F$ or $\pm 0$	SRC	SRC	$+F$	$+\infty$	NaN
	$+\infty$	*	$+\infty$	$+\infty$	$+\infty$	$+\infty$	$+\infty$	NaN
	NaN	NaN	NaN	NaN	NaN	NaN	NaN	NaN

**NOTES:**

F Means finite floating-point value.

I Means integer.

\* Indicates floating-point invalid-arithmetic-operand (#IA) exception.

This instruction's operation is the same in non-64-bit modes and 64-bit mode.

**Operation**

IF Instruction = FIADD

THEN

DEST  $\leftarrow$  DEST + ConvertToDoubleExtendedPrecisionFP(SRC);

ELSE (\* Source operand is floating-point value \*)

DEST  $\leftarrow$  DEST + SRC;

FI;

IF Instruction = FADDP

THEN

PopRegisterStack;

FI;

**FPU Flags Affected**

- C1 Set to 0 if stack underflow occurred.  
Set if result was rounded up; cleared otherwise.
- C0, C2, C3 Undefined.

**Floating-Point Exceptions**

- #IS Stack underflow occurred.
- #IA Operand is an SNaN value or unsupported format.  
Operands are infinities of unlike sign.
- #D Source operand is a denormal value.
- #U Result is too small for destination format.
- #O Result is too large for destination format.
- #P Value cannot be represented exactly in destination format.

**Protected Mode Exceptions**

#GP(0)	If a memory operand effective address is outside the CS, DS, ES, FS, or GS segment limit. If the DS, ES, FS, or GS register contains a NULL segment selector.
#SS(0)	If a memory operand effective address is outside the SS segment limit.
#NM	CR0.EM[bit 2] or CR0.TS[bit 3] = 1.
#PF(fault-code)	If a page fault occurs.
#AC(0)	If alignment checking is enabled and an unaligned memory reference is made while the current privilege level is 3.
#UD	If the LOCK prefix is used.

**Real-Address Mode Exceptions**

#GP	If a memory operand effective address is outside the CS, DS, ES, FS, or GS segment limit.
#SS	If a memory operand effective address is outside the SS segment limit.
#NM	CR0.EM[bit 2] or CR0.TS[bit 3] = 1.
#UD	If the LOCK prefix is used.

**Virtual-8086 Mode Exceptions**

#GP(0)	If a memory operand effective address is outside the CS, DS, ES, FS, or GS segment limit.
#SS(0)	If a memory operand effective address is outside the SS segment limit.
#NM	CR0.EM[bit 2] or CR0.TS[bit 3] = 1.
#PF(fault-code)	If a page fault occurs.
#AC(0)	If alignment checking is enabled and an unaligned memory reference is made.
#UD	If the LOCK prefix is used.

**Compatibility Mode Exceptions**

Same exceptions as in protected mode.

**64-Bit Mode Exceptions**

#SS(0)	If a memory address referencing the SS segment is in a non-canonical form.
#GP(0)	If the memory address is in a non-canonical form.
#NM	CR0.EM[bit 2] or CR0.TS[bit 3] = 1.
#MF	If there is a pending x87 FPU exception.
#PF(fault-code)	If a page fault occurs.
#AC(0)	If alignment checking is enabled and an unaligned memory reference is made while the current privilege level is 3.
#UD	If the LOCK prefix is used.

## FBLD—Load Binary Coded Decimal

Opcode	Instruction	64-Bit Mode	Compat/ Leg Mode	Description
DF /4	FBLD <i>m80bcd</i>	Valid	Valid	Convert BCD value to floating-point and push onto the FPU stack.

### Description

Converts the BCD source operand into double extended-precision floating-point format and pushes the value onto the FPU stack. The source operand is loaded without rounding errors. The sign of the source operand is preserved, including that of  $-0$ .

The packed BCD digits are assumed to be in the range 0 through 9; the instruction does not check for invalid digits (AH through FH). Attempting to load an invalid encoding produces an undefined result.

This instruction's operation is the same in non-64-bit modes and 64-bit mode.

### Operation

TOP  $\leftarrow$  TOP  $- 1$ ;

ST(0)  $\leftarrow$  ConvertToDoubleExtendedPrecisionFP(SRC);

### FPU Flags Affected

C1 Set to 1 if stack overflow occurred; otherwise, set to 0.  
C0, C2, C3 Undefined.

### Floating-Point Exceptions

#IS Stack overflow occurred.

### Protected Mode Exceptions

#GP(0) If a memory operand effective address is outside the CS, DS, ES, FS, or GS segment limit.  
If the DS, ES, FS, or GS register contains a NULL segment selector.  
#SS(0) If a memory operand effective address is outside the SS segment limit.  
#NM CR0.EM[bit 2] or CR0.TS[bit 3] = 1.  
#PF(fault-code) If a page fault occurs.  
#AC(0) If alignment checking is enabled and an unaligned memory reference is made while the current privilege level is 3.  
#UD If the LOCK prefix is used.

### Real-Address Mode Exceptions

#GP If a memory operand effective address is outside the CS, DS, ES, FS, or GS segment limit.  
#SS If a memory operand effective address is outside the SS segment limit.  
#NM CR0.EM[bit 2] or CR0.TS[bit 3] = 1.  
#UD If the LOCK prefix is used.

### Virtual-8086 Mode Exceptions

#GP(0) If a memory operand effective address is outside the CS, DS, ES, FS, or GS segment limit.  
#SS(0) If a memory operand effective address is outside the SS segment limit.  
#NM CR0.EM[bit 2] or CR0.TS[bit 3] = 1.  
#PF(fault-code) If a page fault occurs.  
#AC(0) If alignment checking is enabled and an unaligned memory reference is made.  
#UD If the LOCK prefix is used.

## Compatibility Mode Exceptions

Same exceptions as in protected mode.

## 64-Bit Mode Exceptions

#SS(0)	If a memory address referencing the SS segment is in a non-canonical form.
#GP(0)	If the memory address is in a non-canonical form.
#NM	CR0.EM[bit 2] or CR0.TS[bit 3] = 1.
#MF	If there is a pending x87 FPU exception.
#PF(fault-code)	If a page fault occurs.
#AC(0)	If alignment checking is enabled and an unaligned memory reference is made while the current privilege level is 3.
#UD	If the LOCK prefix is used.

## FBSTP—Store BCD Integer and Pop

Opcode	Instruction	64-Bit Mode	Compat/ Leg Mode	Description
DF /6	FBSTP m80bcd	Valid	Valid	Store ST(0) in m80bcd and pop ST(0).

### Description

Converts the value in the ST(0) register to an 18-digit packed BCD integer, stores the result in the destination operand, and pops the register stack. If the source value is a non-integral value, it is rounded to an integer value, according to rounding mode specified by the RC field of the FPU control word. To pop the register stack, the processor marks the ST(0) register as empty and increments the stack pointer (TOP) by 1.

The destination operand specifies the address where the first byte destination value is to be stored. The BCD value (including its sign bit) requires 10 bytes of space in memory.

The following table shows the results obtained when storing various classes of numbers in packed BCD format.

**Table 3-19. FBSTP Results**

ST(0)	DEST
$-\infty$ or Value Too Large for DEST Format	*
$F \leq -1$	$-D$
$-1 < F < -0$	**
$-0$	$-0$
$+0$	$+0$
$+0 < F < +1$	**
$F \geq +1$	$+D$
$+\infty$ or Value Too Large for DEST Format	*
NaN	*

#### NOTES:

F Means finite floating-point value.

D Means packed-BCD number.

\* Indicates floating-point invalid-operation (#IA) exception.

\*\*  $\pm 0$  or  $\pm 1$ , depending on the rounding mode.

If the converted value is too large for the destination format, or if the source operand is an  $\infty$ , SNaN, QNaN, or is in an unsupported format, an invalid-arithmetic-operand condition is signaled. If the invalid-operation exception is not masked, an invalid-arithmetic-operand exception (#IA) is generated and no value is stored in the destination operand. If the invalid-operation exception is masked, the packed BCD indefinite value is stored in memory.

This instruction's operation is the same in non-64-bit modes and 64-bit mode.

### Operation

DEST  $\leftarrow$  BCD(ST(0));

PopRegisterStack;

### FPU Flags Affected

C1	Set to 0 if stack underflow occurred. Set if result was rounded up; cleared otherwise.
C0, C2, C3	Undefined.

### Floating-Point Exceptions

#IS	Stack underflow occurred.
#IA	Converted value that exceeds 18 BCD digits in length. Source operand is an SNaN, QNaN, $\pm\infty$ , or in an unsupported format.
#P	Value cannot be represented exactly in destination format.

### Protected Mode Exceptions

#GP(0)	If a segment register is being loaded with a segment selector that points to a non-writable segment. If a memory operand effective address is outside the CS, DS, ES, FS, or GS segment limit. If the DS, ES, FS, or GS register contains a NULL segment selector.
#SS(0)	If a memory operand effective address is outside the SS segment limit.
#NM	CR0.EM[bit 2] or CR0.TS[bit 3] = 1.
#PF(fault-code)	If a page fault occurs.
#AC(0)	If alignment checking is enabled and an unaligned memory reference is made while the current privilege level is 3.
#UD	If the LOCK prefix is used.

### Real-Address Mode Exceptions

#GP	If a memory operand effective address is outside the CS, DS, ES, FS, or GS segment limit.
#SS	If a memory operand effective address is outside the SS segment limit.
#NM	CR0.EM[bit 2] or CR0.TS[bit 3] = 1.
#UD	If the LOCK prefix is used.

### Virtual-8086 Mode Exceptions

#GP(0)	If a memory operand effective address is outside the CS, DS, ES, FS, or GS segment limit.
#SS(0)	If a memory operand effective address is outside the SS segment limit.
#NM	CR0.EM[bit 2] or CR0.TS[bit 3] = 1.
#PF(fault-code)	If a page fault occurs.
#AC(0)	If alignment checking is enabled and an unaligned memory reference is made.
#UD	If the LOCK prefix is used.

### Compatibility Mode Exceptions

Same exceptions as in protected mode.

### 64-Bit Mode Exceptions

#SS(0)	If a memory address referencing the SS segment is in a non-canonical form.
#GP(0)	If the memory address is in a non-canonical form.
#NM	CR0.EM[bit 2] or CR0.TS[bit 3] = 1.
#MF	If there is a pending x87 FPU exception.
#PF(fault-code)	If a page fault occurs.
#AC(0)	If alignment checking is enabled and an unaligned memory reference is made while the current privilege level is 3.
#UD	If the LOCK prefix is used.

## FCFS—Change Sign

Opcode	Instruction	64-Bit Mode	Compat/ Leg Mode	Description
D9 E0	FCFS	Valid	Valid	Complements sign of ST(0).

### Description

Complements the sign bit of ST(0). This operation changes a positive value into a negative value of equal magnitude or vice versa. The following table shows the results obtained when changing the sign of various classes of numbers.

**Table 3-20. FCFS Results**

ST(0) SRC	ST(0) DEST
$-\infty$	$+\infty$
- F	+ F
- 0	+ 0
+ 0	- 0
+ F	- F
$+\infty$	$-\infty$
NaN	NaN

#### NOTES:

\* F means finite floating-point value.

This instruction's operation is the same in non-64-bit modes and 64-bit mode.

### Operation

SignBit(ST(0)) ← NOT (SignBit(ST(0)));

### FPU Flags Affected

C1                      Set to 0.  
C0, C2, C3            Undefined.

### Floating-Point Exceptions

#IS                     Stack underflow occurred.

### Protected Mode Exceptions

#NM                    CR0.EM[bit 2] or CR0.TS[bit 3] = 1.  
#UD                    If the LOCK prefix is used.

### Real-Address Mode Exceptions

Same exceptions as in protected mode.

### Virtual-8086 Mode Exceptions

Same exceptions as in protected mode.

### Compatibility Mode Exceptions

Same exceptions as in protected mode.



## 64-Bit Mode Exceptions

Same exceptions as in protected mode.

## FCLEX/FNCLEX—Clear Exceptions

Opcode*	Instruction	64-Bit Mode	Compat/ Leg Mode	Description
9B DB E2	FCLEX	Valid	Valid	Clear floating-point exception flags after checking for pending unmasked floating-point exceptions.
DB E2	FNCLEX*	Valid	Valid	Clear floating-point exception flags without checking for pending unmasked floating-point exceptions.

### NOTES:

\* See IA-32 Architecture Compatibility section below.

### Description

Clears the floating-point exception flags (PE, UE, OE, ZE, DE, and IE), the exception summary status flag (ES), the stack fault flag (SF), and the busy flag (B) in the FPU status word. The FCLEX instruction checks for and handles any pending unmasked floating-point exceptions before clearing the exception flags; the FNCLEX instruction does not.

The assembler issues two instructions for the FCLEX instruction (an FWAIT instruction followed by an FNCLEX instruction), and the processor executes each of these instructions separately. If an exception is generated for either of these instructions, the save EIP points to the instruction that caused the exception.

### IA-32 Architecture Compatibility

When operating a Pentium or Intel486 processor in MS-DOS\* compatibility mode, it is possible (under unusual circumstances) for an FNCLEX instruction to be interrupted prior to being executed to handle a pending FPU exception. See the section titled “No-Wait FPU Instructions Can Get FPU Interrupt in Window” in Appendix D of the *Intel® 64 and IA-32 Architectures Software Developer’s Manual, Volume 1*, for a description of these circumstances. An FNCLEX instruction cannot be interrupted in this way on later Intel processors, except for the Intel Quark™ X1000 processor.

This instruction affects only the x87 FPU floating-point exception flags. It does not affect the SIMD floating-point exception flags in the MXCRS register.

This instruction’s operation is the same in non-64-bit modes and 64-bit mode.

### Operation

FPUStatusWord[0:7] ← 0;  
FPUStatusWord[15] ← 0;

### FPU Flags Affected

The PE, UE, OE, ZE, DE, IE, ES, SF, and B flags in the FPU status word are cleared. The C0, C1, C2, and C3 flags are undefined.

### Floating-Point Exceptions

None

### Protected Mode Exceptions

#NM CR0.EM[bit 2] or CR0.TS[bit 3] = 1.  
#UD If the LOCK prefix is used.

### Real-Address Mode Exceptions

Same exceptions as in protected mode.

**Virtual-8086 Mode Exceptions**

Same exceptions as in protected mode.

**Compatibility Mode Exceptions**

Same exceptions as in protected mode.

**64-Bit Mode Exceptions**

Same exceptions as in protected mode.

## FCMOV<sub>cc</sub>—Floating-Point Conditional Move

Opcode*	Instruction	64-Bit Mode	Compat/ Leg Mode*	Description
DA C0+i	FCMOVB ST(0), ST(i)	Valid	Valid	Move if below (CF=1).
DA C8+i	FCMOVE ST(0), ST(i)	Valid	Valid	Move if equal (ZF=1).
DA D0+i	FCMOVBE ST(0), ST(i)	Valid	Valid	Move if below or equal (CF=1 or ZF=1).
DA D8+i	FCMOVU ST(0), ST(i)	Valid	Valid	Move if unordered (PF=1).
DB C0+i	FCMOVNB ST(0), ST(i)	Valid	Valid	Move if not below (CF=0).
DB C8+i	FCMOVNE ST(0), ST(i)	Valid	Valid	Move if not equal (ZF=0).
DB D0+i	FCMOVNBE ST(0), ST(i)	Valid	Valid	Move if not below or equal (CF=0 and ZF=0).
DB D8+i	FCMOVNU ST(0), ST(i)	Valid	Valid	Move if not unordered (PF=0).

### NOTES:

\* See IA-32 Architecture Compatibility section below.

### Description

Tests the status flags in the EFLAGS register and moves the source operand (second operand) to the destination operand (first operand) if the given test condition is true. The condition for each mnemonic is given in the Description column above and in Chapter 8 in the *Intel® 64 and IA-32 Architectures Software Developer's Manual, Volume 1*. The source operand is always in the ST(i) register and the destination operand is always ST(0).

The FCMOV<sub>cc</sub> instructions are useful for optimizing small IF constructions. They also help eliminate branching overhead for IF operations and the possibility of branch mispredictions by the processor.

A processor may not support the FCMOV<sub>cc</sub> instructions. Software can check if the FCMOV<sub>cc</sub> instructions are supported by checking the processor's feature information with the CPUID instruction (see "COMISS—Compare Scalar Ordered Single-Precision Floating-Point Values and Set EFLAGS" in this chapter). If both the CMOV and FPU feature bits are set, the FCMOV<sub>cc</sub> instructions are supported.

This instruction's operation is the same in non-64-bit modes and 64-bit mode.

### IA-32 Architecture Compatibility

The FCMOV<sub>cc</sub> instructions were introduced to the IA-32 Architecture in the P6 family processors and are not available in earlier IA-32 processors.

### Operation

```
IF condition TRUE
    THEN ST(0) ← ST(i);
FI;
```

### FPU Flags Affected

C1                      Set to 0 if stack underflow occurred.  
C0, C2, C3              Undefined.

### Floating-Point Exceptions

#IS                      Stack underflow occurred.

### Integer Flags Affected

None.

### Protected Mode Exceptions

#NM CR0.EM[bit 2] or CR0.TS[bit 3] = 1.  
#UD If the LOCK prefix is used.

### Real-Address Mode Exceptions

Same exceptions as in protected mode.

### Virtual-8086 Mode Exceptions

Same exceptions as in protected mode.

### Compatibility Mode Exceptions

Same exceptions as in protected mode.

### 64-Bit Mode Exceptions

Same exceptions as in protected mode.

## FCOM/FCOMP/FCOMPP—Compare Floating Point Values

Opcode	Instruction	64-Bit Mode	Compat/ Leg Mode	Description
D8 /2	FCOM <i>m32fp</i>	Valid	Valid	Compare ST(0) with <i>m32fp</i> .
DC /2	FCOM <i>m64fp</i>	Valid	Valid	Compare ST(0) with <i>m64fp</i> .
D8 D0+i	FCOM ST(i)	Valid	Valid	Compare ST(0) with ST(i).
D8 D1	FCOM	Valid	Valid	Compare ST(0) with ST(1).
D8 /3	FCOMP <i>m32fp</i>	Valid	Valid	Compare ST(0) with <i>m32fp</i> and pop register stack.
DC /3	FCOMP <i>m64fp</i>	Valid	Valid	Compare ST(0) with <i>m64fp</i> and pop register stack.
D8 D8+i	FCOMP ST(i)	Valid	Valid	Compare ST(0) with ST(i) and pop register stack.
D8 D9	FCOMP	Valid	Valid	Compare ST(0) with ST(1) and pop register stack.
DE D9	FCOMPP	Valid	Valid	Compare ST(0) with ST(1) and pop register stack twice.

### Description

Compares the contents of register ST(0) and source value and sets condition code flags C0, C2, and C3 in the FPU status word according to the results (see the table below). The source operand can be a data register or a memory location. If no source operand is given, the value in ST(0) is compared with the value in ST(1). The sign of zero is ignored, so that  $-0.0$  is equal to  $+0.0$ .

**Table 3-21. FCOM/FCOMP/FCOMPP Results**

Condition	C3	C2	C0
ST(0) > SRC	0	0	0
ST(0) < SRC	0	0	1
ST(0) = SRC	1	0	0
Unordered*	1	1	1

#### NOTES:

\* Flags not set if unmasked invalid-arithmic-operand (#IA) exception is generated.

This instruction checks the class of the numbers being compared (see “FXAM—Examine Floating-Point” in this chapter). If either operand is a NaN or is in an unsupported format, an invalid-arithmic-operand exception (#IA) is raised and, if the exception is masked, the condition flags are set to “unordered.” If the invalid-arithmic-operand exception is unmasked, the condition code flags are not set.

The FCOMP instruction pops the register stack following the comparison operation and the FCOMPP instruction pops the register stack twice following the comparison operation. To pop the register stack, the processor marks the ST(0) register as empty and increments the stack pointer (TOP) by 1.

The FCOM instructions perform the same operation as the FUCOM instructions. The only difference is how they handle QNaN operands. The FCOM instructions raise an invalid-arithmic-operand exception (#IA) when either or both of the operands is a NaN value or is in an unsupported format. The FUCOM instructions perform the same operation as the FCOM instructions, except that they do not generate an invalid-arithmic-operand exception for QNaNs.

This instruction’s operation is the same in non-64-bit modes and 64-bit mode.

## Operation

CASE (relation of operands) OF

ST > SRC: C3, C2, C0 ← 000;

ST < SRC: C3, C2, C0 ← 001;

ST = SRC: C3, C2, C0 ← 100;

ESAC;

IF ST(0) or SRC = NaN or unsupported format

THEN

#IA

IF FPUControlWord.IM = 1

THEN

C3, C2, C0 ← 111;

FI;

FI;

IF Instruction = FCOMP

THEN

PopRegisterStack;

FI;

IF Instruction = FCOMPP

THEN

PopRegisterStack;

PopRegisterStack;

FI;

## FPU Flags Affected

C1 Set to 0.

C0, C2, C3 See table on previous page.

## Floating-Point Exceptions

#IS Stack underflow occurred.

#IA One or both operands are NaN values or have unsupported formats.

Register is marked empty.

#D One or both operands are denormal values.

## Protected Mode Exceptions

#GP(0) If a memory operand effective address is outside the CS, DS, ES, FS, or GS segment limit.

If the DS, ES, FS, or GS register contains a NULL segment selector.

#SS(0) If a memory operand effective address is outside the SS segment limit.

#NM CR0.EM[bit 2] or CR0.TS[bit 3] = 1.

#PF(fault-code) If a page fault occurs.

#AC(0) If alignment checking is enabled and an unaligned memory reference is made while the current privilege level is 3.

#UD If the LOCK prefix is used.

## Real-Address Mode Exceptions

#GP If a memory operand effective address is outside the CS, DS, ES, FS, or GS segment limit.

#SS If a memory operand effective address is outside the SS segment limit.

#NM CR0.EM[bit 2] or CR0.TS[bit 3] = 1.

#UD If the LOCK prefix is used.

### Virtual-8086 Mode Exceptions

#GP(0)	If a memory operand effective address is outside the CS, DS, ES, FS, or GS segment limit.
#SS(0)	If a memory operand effective address is outside the SS segment limit.
#NM	CR0.EM[bit 2] or CR0.TS[bit 3] = 1.
#PF(fault-code)	If a page fault occurs.
#AC(0)	If alignment checking is enabled and an unaligned memory reference is made.
#UD	If the LOCK prefix is used.

### Compatibility Mode Exceptions

Same exceptions as in protected mode.

### 64-Bit Mode Exceptions

#SS(0)	If a memory address referencing the SS segment is in a non-canonical form.
#GP(0)	If the memory address is in a non-canonical form.
#NM	CR0.EM[bit 2] or CR0.TS[bit 3] = 1.
#MF	If there is a pending x87 FPU exception.
#PF(fault-code)	If a page fault occurs.
#AC(0)	If alignment checking is enabled and an unaligned memory reference is made while the current privilege level is 3.
#UD	If the LOCK prefix is used.



## FCOMI/FCOMIP/FUCOMI/FUCOMIP—Compare Floating Point Values and Set EFLAGS

Opcode	Instruction	64-Bit Mode	Compat/Leg Mode	Description
DB F0+i	FCOMI ST, ST(i)	Valid	Valid	Compare ST(0) with ST(i) and set status flags accordingly.
DF F0+i	FCOMIP ST, ST(i)	Valid	Valid	Compare ST(0) with ST(i), set status flags accordingly, and pop register stack.
DB E8+i	FUCOMI ST, ST(i)	Valid	Valid	Compare ST(0) with ST(i), check for ordered values, and set status flags accordingly.
DF E8+i	FUCOMIP ST, ST(i)	Valid	Valid	Compare ST(0) with ST(i), check for ordered values, set status flags accordingly, and pop register stack.

### Description

Performs an unordered comparison of the contents of registers ST(0) and ST(i) and sets the status flags ZF, PF, and CF in the EFLAGS register according to the results (see the table below). The sign of zero is ignored for comparisons, so that  $-0.0$  is equal to  $+0.0$ .

**Table 3-22. FCOMI/FCOMIP/ FUCOMI/FUCOMIP Results**

Comparison Results*	ZF	PF	CF
ST0 > ST(i)	0	0	0
ST0 < ST(i)	0	0	1
ST0 = ST(i)	1	0	0
Unordered**	1	1	1

#### NOTES:

\* See the IA-32 Architecture Compatibility section below.

\*\* Flags not set if unmasked invalid-arithmetic-operand (#IA) exception is generated.

An unordered comparison checks the class of the numbers being compared (see “FXAM—Examine Floating-Point” in this chapter). The FUCOMI/FUCOMIP instructions perform the same operations as the FCOMI/FCOMIP instructions. The only difference is that the FUCOMI/FUCOMIP instructions raise the invalid-arithmetic-operand exception (#IA) only when either or both operands are an SNaN or are in an unsupported format; QNaNs cause the condition code flags to be set to unordered, but do not cause an exception to be generated. The FCOMI/FCOMIP instructions raise an invalid-operation exception when either or both of the operands are a NaN value of any kind or are in an unsupported format.

If the operation results in an invalid-arithmetic-operand exception being raised, the status flags in the EFLAGS register are set only if the exception is masked.

The FCOMI/FCOMIP and FUCOMI/FUCOMIP instructions set the OF, SF and AF flags to zero in the EFLAGS register (regardless of whether an invalid-operation exception is detected).

The FCOMIP and FUCOMIP instructions also pop the register stack following the comparison operation. To pop the register stack, the processor marks the ST(0) register as empty and increments the stack pointer (TOP) by 1.

This instruction’s operation is the same in non-64-bit modes and 64-bit mode.

### IA-32 Architecture Compatibility

The FCOMI/FCOMIP/FUCOMI/FUCOMIP instructions were introduced to the IA-32 Architecture in the P6 family processors and are not available in earlier IA-32 processors.

**Operation**

CASE (relation of operands) OF

ST(0) > ST(i): ZF, PF, CF ← 000;

ST(0) < ST(i): ZF, PF, CF ← 001;

ST(0) = ST(i): ZF, PF, CF ← 100;

ESAC;

IF Instruction is FCOMI or FCOMIP

THEN

IF ST(0) or ST(i) = NaN or unsupported format

THEN

#IA

IF FPUControlWord.IM = 1

THEN

ZF, PF, CF ← 111;

FI;

FI;

FI;

IF Instruction is FUCOMI or FUCOMIP

THEN

IF ST(0) or ST(i) = QNaN, but not SNaN or unsupported format

THEN

ZF, PF, CF ← 111;

ELSE (\* ST(0) or ST(i) is SNaN or unsupported format \*)

#IA;

IF FPUControlWord.IM = 1

THEN

ZF, PF, CF ← 111;

FI;

FI;

FI;

IF Instruction is FCOMIP or FUCOMIP

THEN

PopRegisterStack;

FI;

**FPU Flags Affected**

C1 Set to 0.

C0, C2, C3 Not affected.

**Floating-Point Exceptions**

#IS Stack underflow occurred.

#IA (FCOMI or FCOMIP instruction) One or both operands are NaN values or have unsupported formats.  
(FUCOMI or FUCOMIP instruction) One or both operands are SNaN values (but not QNaNs) or have undefined formats. Detection of a QNaN value does not raise an invalid-operand exception.

### Protected Mode Exceptions

#NM	CR0.EM[bit 2] or CR0.TS[bit 3] = 1.
#MF	If there is a pending x87 FPU exception.
#UD	If the LOCK prefix is used.

### Real-Address Mode Exceptions

Same exceptions as in protected mode.

### Virtual-8086 Mode Exceptions

Same exceptions as in protected mode.

### Compatibility Mode Exceptions

Same exceptions as in protected mode.

### 64-Bit Mode Exceptions

Same exceptions as in protected mode.

## FCOS— Cosine

Opcode	Instruction	64-Bit Mode	Compat/ Leg Mode	Description
D9 FF	FCOS	Valid	Valid	Replace ST(0) with its approximate cosine.

### Description

Computes the approximate cosine of the source operand in register ST(0) and stores the result in ST(0). The source operand must be given in radians and must be within the range  $-2^{63}$  to  $+2^{63}$ . The following table shows the results obtained when taking the cosine of various classes of numbers.

**Table 3-23. FCOS Results**

ST(0) SRC	ST(0) DEST
$-\infty$	*
$-F$	$-1$ to $+1$
$-0$	$+1$
$+0$	$+1$
$+F$	$-1$ to $+1$
$+\infty$	*
NaN	NaN

#### NOTES:

F Means finite floating-point value.

\* Indicates floating-point invalid-arithmetic-operand (#IA) exception.

If the source operand is outside the acceptable range, the C2 flag in the FPU status word is set, and the value in register ST(0) remains unchanged. The instruction does not raise an exception when the source operand is out of range. It is up to the program to check the C2 flag for out-of-range conditions. Source values outside the range  $-2^{63}$  to  $+2^{63}$  can be reduced to the range of the instruction by subtracting an appropriate integer multiple of  $2\pi$ . However, even within the range  $-2^{63}$  to  $+2^{63}$ , inaccurate results can occur because the finite approximation of  $\pi$  used internally for argument reduction is not sufficient in all cases. Therefore, for accurate results it is safe to apply FCOS only to arguments reduced accurately in software, to a value smaller in absolute value than  $3\pi/8$ . See the sections titled "Approximation of Pi" and "Transcendental Instruction Accuracy" in Chapter 8 of the *Intel® 64 and IA-32 Architectures Software Developer's Manual, Volume 1*, for a discussion of the proper value to use for  $\pi$  in performing such reductions.

This instruction's operation is the same in non-64-bit modes and 64-bit mode.

### Operation

```
IF |ST(0)| < 263
THEN
  C2 ← 0;
  ST(0) ← FCOS(ST(0)); // approximation of cosine
ELSE (* Source operand is out-of-range *)
  C2 ← 1;
FI;
```

**FPU Flags Affected**

C1	Set to 0 if stack underflow occurred. Set if result was rounded up; cleared otherwise. Undefined if C2 is 1.
C2	Set to 1 if outside range ( $-2^{63} < \text{source operand} < +2^{63}$ ); otherwise, set to 0.
C0, C3	Undefined.

**Floating-Point Exceptions**

#IS	Stack underflow occurred.
#IA	Source operand is an SNaN value, $\infty$ , or unsupported format.
#D	Source is a denormal value.
#P	Value cannot be represented exactly in destination format.

**Protected Mode Exceptions**

#NM	CR0.EM[bit 2] or CR0.TS[bit 3] = 1.
#MF	If there is a pending x87 FPU exception.
#UD	If the LOCK prefix is used.

**Real-Address Mode Exceptions**

Same exceptions as in protected mode.

**Virtual-8086 Mode Exceptions**

Same exceptions as in protected mode.

**Compatibility Mode Exceptions**

Same exceptions as in protected mode.

**64-Bit Mode Exceptions**

Same exceptions as in protected mode.

## FDECSTP—Decrement Stack-Top Pointer

Opcode	Instruction	64-Bit Mode	Compat/ Leg Mode	Description
D9 F6	FDECSTP	Valid	Valid	Decrement TOP field in FPU status word.

### Description

Subtracts one from the TOP field of the FPU status word (decrements the top-of-stack pointer). If the TOP field contains a 0, it is set to 7. The effect of this instruction is to rotate the stack by one position. The contents of the FPU data registers and tag register are not affected.

This instruction's operation is the same in non-64-bit modes and 64-bit mode.

### Operation

```
IF TOP = 0
    THEN TOP ← 7;
    ELSE TOP ← TOP - 1;
FI;
```

### FPU Flags Affected

The C1 flag is set to 0. The C0, C2, and C3 flags are undefined.

### Floating-Point Exceptions

None.

### Protected Mode Exceptions

#NM CR0.EM[bit 2] or CR0.TS[bit 3] = 1.  
 #MF If there is a pending x87 FPU exception.  
 #UD If the LOCK prefix is used.

### Real-Address Mode Exceptions

Same exceptions as in protected mode.

### Virtual-8086 Mode Exceptions

Same exceptions as in protected mode.

### Compatibility Mode Exceptions

Same exceptions as in protected mode.

### 64-Bit Mode Exceptions

Same exceptions as in protected mode.

## FDIV/FDIVP/FIDIV—Divide

Opcode	Instruction	64-Bit Mode	Compat/ Leg Mode	Description
D8 /6	FDIV <i>m32fp</i>	Valid	Valid	Divide ST(0) by <i>m32fp</i> and store result in ST(0).
DC /6	FDIV <i>m64fp</i>	Valid	Valid	Divide ST(0) by <i>m64fp</i> and store result in ST(0).
D8 F0+i	FDIV ST(0), ST(i)	Valid	Valid	Divide ST(0) by ST(i) and store result in ST(0).
DC F8+i	FDIV ST(i), ST(0)	Valid	Valid	Divide ST(i) by ST(0) and store result in ST(i).
DE F8+i	FDIVP ST(i), ST(0)	Valid	Valid	Divide ST(i) by ST(0), store result in ST(i), and pop the register stack.
DE F9	FDIVP	Valid	Valid	Divide ST(1) by ST(0), store result in ST(1), and pop the register stack.
DA /6	FIDIV <i>m32int</i>	Valid	Valid	Divide ST(0) by <i>m32int</i> and store result in ST(0).
DE /6	FIDIV <i>m16int</i>	Valid	Valid	Divide ST(0) by <i>m16int</i> and store result in ST(0).

### Description

Divides the destination operand by the source operand and stores the result in the destination location. The destination operand (dividend) is always in an FPU register; the source operand (divisor) can be a register or a memory location. Source operands in memory can be in single-precision or double-precision floating-point format, word or doubleword integer format.

The no-operand version of the instruction divides the contents of the ST(1) register by the contents of the ST(0) register. The one-operand version divides the contents of the ST(0) register by the contents of a memory location (either a floating-point or an integer value). The two-operand version, divides the contents of the ST(0) register by the contents of the ST(i) register or vice versa.

The FDIVP instructions perform the additional operation of popping the FPU register stack after storing the result. To pop the register stack, the processor marks the ST(0) register as empty and increments the stack pointer (TOP) by 1. The no-operand version of the floating-point divide instructions always results in the register stack being popped. In some assemblers, the mnemonic for this instruction is FDIV rather than FDIVP.

The FIDIV instructions convert an integer source operand to double extended-precision floating-point format before performing the division. When the source operand is an integer 0, it is treated as a +0.

If an unmasked divide-by-zero exception (#Z) is generated, no result is stored; if the exception is masked, an  $\infty$  of the appropriate sign is stored in the destination operand.

The following table shows the results obtained when dividing various classes of numbers, assuming that neither overflow nor underflow occurs.

Table 3-24. FDIV/FDIVP/FIDIV Results

		DEST						
		$-\infty$	$-F$	$-0$	$+0$	$+F$	$+\infty$	
SRC	$-\infty$	*	$+0$	$+0$	$-0$	$-0$	*	NaN
	$-F$	$+\infty$	$+F$	$+0$	$-0$	$-F$	$-\infty$	NaN
	$-I$	$+\infty$	$+F$	$+0$	$-0$	$-F$	$-\infty$	NaN
	$-0$	$+\infty$	**	*	*	**	$-\infty$	NaN
	$+0$	$-\infty$	**	*	*	**	$+\infty$	NaN
	$+I$	$-\infty$	$-F$	$-0$	$+0$	$+F$	$+\infty$	NaN
	$+F$	$-\infty$	$-F$	$-0$	$+0$	$+F$	$+\infty$	NaN
	$+\infty$	*	$-0$	$-0$	$+0$	$+0$	*	NaN
	NaN	NaN	NaN	NaN	NaN	NaN	NaN	NaN

**NOTES:**

F Means finite floating-point value.

I Means integer.

\* Indicates floating-point invalid-arithmetic-operand (#IA) exception.

\*\* Indicates floating-point zero-divide (#Z) exception.

This instruction's operation is the same in non-64-bit modes and 64-bit mode.

**Operation**

```

IF SRC = 0
  THEN
    #Z;
  ELSE
    IF Instruction is FIDIV
      THEN
        DEST ← DEST / ConvertToDoubleExtendedPrecisionFP(SRC);
      ELSE (* Source operand is floating-point value *)
        DEST ← DEST / SRC;
    FI;
  FI;

```

```

IF Instruction = FDIVP
  THEN
    PopRegisterStack;
  FI;

```

**FPU Flags Affected**

C1 Set to 0 if stack underflow occurred.  
Set if result was rounded up; cleared otherwise.

C0, C2, C3 Undefined.



### Floating-Point Exceptions

#IS	Stack underflow occurred.
#IA	Operand is an SNaN value or unsupported format. $\pm\infty / \pm\infty$ ; $\pm 0 / \pm 0$
#D	Source is a denormal value.
#Z	DEST / $\pm 0$ , where DEST is not equal to $\pm 0$ .
#U	Result is too small for destination format.
#O	Result is too large for destination format.
#P	Value cannot be represented exactly in destination format.

### Protected Mode Exceptions

#GP(0)	If a memory operand effective address is outside the CS, DS, ES, FS, or GS segment limit. If the DS, ES, FS, or GS register contains a NULL segment selector.
#SS(0)	If a memory operand effective address is outside the SS segment limit.
#NM	CR0.EM[bit 2] or CR0.TS[bit 3] = 1.
#PF(fault-code)	If a page fault occurs.
#AC(0)	If alignment checking is enabled and an unaligned memory reference is made while the current privilege level is 3.
#UD	If the LOCK prefix is used.

### Real-Address Mode Exceptions

#GP	If a memory operand effective address is outside the CS, DS, ES, FS, or GS segment limit.
#SS	If a memory operand effective address is outside the SS segment limit.
#NM	CR0.EM[bit 2] or CR0.TS[bit 3] = 1.
#UD	If the LOCK prefix is used.

### Virtual-8086 Mode Exceptions

#GP(0)	If a memory operand effective address is outside the CS, DS, ES, FS, or GS segment limit.
#SS(0)	If a memory operand effective address is outside the SS segment limit.
#NM	CR0.EM[bit 2] or CR0.TS[bit 3] = 1.
#PF(fault-code)	If a page fault occurs.
#AC(0)	If alignment checking is enabled and an unaligned memory reference is made.
#UD	If the LOCK prefix is used.

### Compatibility Mode Exceptions

Same exceptions as in protected mode.

### 64-Bit Mode Exceptions

#SS(0)	If a memory address referencing the SS segment is in a non-canonical form.
#GP(0)	If the memory address is in a non-canonical form.
#NM	CR0.EM[bit 2] or CR0.TS[bit 3] = 1.
#MF	If there is a pending x87 FPU exception.
#PF(fault-code)	If a page fault occurs.
#AC(0)	If alignment checking is enabled and an unaligned memory reference is made while the current privilege level is 3.
#UD	If the LOCK prefix is used.

## FDIVR/FDIVRP/FIDIVR—Reverse Divide

Opcode	Instruction	64-Bit Mode	Compat/ Leg Mode	Description
D8 /7	FDIVR <i>m32fp</i>	Valid	Valid	Divide <i>m32fp</i> by ST(0) and store result in ST(0).
DC /7	FDIVR <i>m64fp</i>	Valid	Valid	Divide <i>m64fp</i> by ST(0) and store result in ST(0).
D8 F8+i	FDIVR ST(0), ST(i)	Valid	Valid	Divide ST(i) by ST(0) and store result in ST(0).
DC F0+i	FDIVR ST(i), ST(0)	Valid	Valid	Divide ST(0) by ST(i) and store result in ST(i).
DE F0+i	FDIVRP ST(i), ST(0)	Valid	Valid	Divide ST(0) by ST(i), store result in ST(i), and pop the register stack.
DE F1	FDIVRP	Valid	Valid	Divide ST(0) by ST(1), store result in ST(1), and pop the register stack.
DA /7	FIDIVR <i>m32int</i>	Valid	Valid	Divide <i>m32int</i> by ST(0) and store result in ST(0).
DE /7	FIDIVR <i>m16int</i>	Valid	Valid	Divide <i>m16int</i> by ST(0) and store result in ST(0).

### Description

Divides the source operand by the destination operand and stores the result in the destination location. The destination operand (divisor) is always in an FPU register; the source operand (dividend) can be a register or a memory location. Source operands in memory can be in single-precision or double-precision floating-point format, word or doubleword integer format.

These instructions perform the reverse operations of the FDIV, FDIVP, and FIDIV instructions. They are provided to support more efficient coding.

The no-operand version of the instruction divides the contents of the ST(0) register by the contents of the ST(1) register. The one-operand version divides the contents of a memory location (either a floating-point or an integer value) by the contents of the ST(0) register. The two-operand version, divides the contents of the ST(i) register by the contents of the ST(0) register or vice versa.

The FDIVRP instructions perform the additional operation of popping the FPU register stack after storing the result. To pop the register stack, the processor marks the ST(0) register as empty and increments the stack pointer (TOP) by 1. The no-operand version of the floating-point divide instructions always results in the register stack being popped. In some assemblers, the mnemonic for this instruction is FDIVR rather than FDIVRP.

The FIDIVR instructions convert an integer source operand to double extended-precision floating-point format before performing the division.

If an unmasked divide-by-zero exception (#Z) is generated, no result is stored; if the exception is masked, an  $\infty$  of the appropriate sign is stored in the destination operand.

The following table shows the results obtained when dividing various classes of numbers, assuming that neither overflow nor underflow occurs.

Table 3-25. FDIVR/FDIVRP/FIDIVR Results

		DEST						
		$-\infty$	$-F$	$-0$	$+0$	$+F$	$+\infty$	
SRC	$-\infty$	*	$+\infty$	$+\infty$	$-\infty$	$-\infty$	*	NaN
	$-F$	$+0$	$+F$	**	**	$-F$	$-0$	NaN
	$-I$	$+0$	$+F$	**	**	$-F$	$-0$	NaN
	$-0$	$+0$	$+0$	*	*	$-0$	$-0$	NaN
	$+0$	$-0$	$-0$	*	*	$+0$	$+0$	NaN
	$+I$	$-0$	$-F$	**	**	$+F$	$+0$	NaN
	$+F$	$-0$	$-F$	**	**	$+F$	$+0$	NaN
	$+\infty$	*	$-\infty$	$-\infty$	$+\infty$	$+\infty$	*	NaN
	NaN	NaN	NaN	NaN	NaN	NaN	NaN	NaN

**NOTES:**

F Means finite floating-point value.

I Means integer.

\* Indicates floating-point invalid-arithmic-operand (#IA) exception.

\*\* Indicates floating-point zero-divide (#Z) exception.

When the source operand is an integer 0, it is treated as a +0. This instruction's operation is the same in non-64-bit modes and 64-bit mode.

**Operation**

```

IF DEST = 0
  THEN
    #Z;
  ELSE
    IF Instruction = FIDIVR
      THEN
        DEST ← ConvertToDoubleExtendedPrecisionFP(SRC) / DEST;
      ELSE (* Source operand is floating-point value *)
        DEST ← SRC / DEST;
    FI;
  FI;
IF Instruction = FDIVRP
  THEN
    PopRegisterStack;
  FI;

```

**FPU Flags Affected**

C1 Set to 0 if stack underflow occurred.  
Set if result was rounded up; cleared otherwise.

C0, C2, C3 Undefined.

**Floating-Point Exceptions**

#IS	Stack underflow occurred.
#IA	Operand is an SNaN value or unsupported format. $\pm\infty / \pm\infty$ ; $\pm 0 / \pm 0$
#D	Source is a denormal value.
#Z	$SRC / \pm 0$ , where SRC is not equal to $\pm 0$ .
#U	Result is too small for destination format.
#O	Result is too large for destination format.
#P	Value cannot be represented exactly in destination format.

**Protected Mode Exceptions**

#GP(0)	If a memory operand effective address is outside the CS, DS, ES, FS, or GS segment limit. If the DS, ES, FS, or GS register contains a NULL segment selector.
#SS(0)	If a memory operand effective address is outside the SS segment limit.
#NM	$CR0.EM[\text{bit } 2]$ or $CR0.TS[\text{bit } 3] = 1$ .
#PF(fault-code)	If a page fault occurs.
#AC(0)	If alignment checking is enabled and an unaligned memory reference is made while the current privilege level is 3.
#UD	If the LOCK prefix is used.

**Real-Address Mode Exceptions**

#GP	If a memory operand effective address is outside the CS, DS, ES, FS, or GS segment limit.
#SS	If a memory operand effective address is outside the SS segment limit.
#NM	$CR0.EM[\text{bit } 2]$ or $CR0.TS[\text{bit } 3] = 1$ .
#UD	If the LOCK prefix is used.

**Virtual-8086 Mode Exceptions**

#GP(0)	If a memory operand effective address is outside the CS, DS, ES, FS, or GS segment limit.
#SS(0)	If a memory operand effective address is outside the SS segment limit.
#NM	$CR0.EM[\text{bit } 2]$ or $CR0.TS[\text{bit } 3] = 1$ .
#PF(fault-code)	If a page fault occurs.
#AC(0)	If alignment checking is enabled and an unaligned memory reference is made.
#UD	If the LOCK prefix is used.

**Compatibility Mode Exceptions**

Same exceptions as in protected mode.

**64-Bit Mode Exceptions**

#SS(0)	If a memory address referencing the SS segment is in a non-canonical form.
#GP(0)	If the memory address is in a non-canonical form.
#NM	$CR0.EM[\text{bit } 2]$ or $CR0.TS[\text{bit } 3] = 1$ .
#MF	If there is a pending x87 FPU exception.
#PF(fault-code)	If a page fault occurs.
#AC(0)	If alignment checking is enabled and an unaligned memory reference is made while the current privilege level is 3.
#UD	If the LOCK prefix is used.

## FFREE—Free Floating-Point Register

Opcode	Instruction	64-Bit Mode	Compat/ Leg Mode	Description
DD C0+i	FFREE ST(i)	Valid	Valid	Sets tag for ST(i) to empty.

### Description

Sets the tag in the FPU tag register associated with register ST(i) to empty (11B). The contents of ST(i) and the FPU stack-top pointer (TOP) are not affected.

This instruction's operation is the same in non-64-bit modes and 64-bit mode.

### Operation

TAG(i) ← 11B;

### FPU Flags Affected

C0, C1, C2, C3 undefined.

### Floating-Point Exceptions

None

### Protected Mode Exceptions

#NM CR0.EM[bit 2] or CR0.TS[bit 3] = 1.  
 #MF If there is a pending x87 FPU exception.  
 #UD If the LOCK prefix is used.

### Real-Address Mode Exceptions

Same exceptions as in protected mode.

### Virtual-8086 Mode Exceptions

Same exceptions as in protected mode.

### Compatibility Mode Exceptions

Same exceptions as in protected mode.

### 64-Bit Mode Exceptions

Same exceptions as in protected mode.

## FICOM/FICOMP—Compare Integer

Opcode	Instruction	64-Bit Mode	Compat/ Leg Mode	Description
DE /2	FICOM <i>m16int</i>	Valid	Valid	Compare ST(0) with <i>m16int</i> .
DA /2	FICOM <i>m32int</i>	Valid	Valid	Compare ST(0) with <i>m32int</i> .
DE /3	FICOMP <i>m16int</i>	Valid	Valid	Compare ST(0) with <i>m16int</i> and pop stack register.
DA /3	FICOMP <i>m32int</i>	Valid	Valid	Compare ST(0) with <i>m32int</i> and pop stack register.

### Description

Compares the value in ST(0) with an integer source operand and sets the condition code flags C0, C2, and C3 in the FPU status word according to the results (see table below). The integer value is converted to double extended-precision floating-point format before the comparison is made.

**Table 3-26. FICOM/FICOMP Results**

Condition	C3	C2	C0
ST(0) > SRC	0	0	0
ST(0) < SRC	0	0	1
ST(0) = SRC	1	0	0
Unordered	1	1	1

These instructions perform an “unordered comparison.” An unordered comparison also checks the class of the numbers being compared (see “FXAM—Examine Floating-Point” in this chapter). If either operand is a NaN or is in an undefined format, the condition flags are set to “unordered.”

The sign of zero is ignored, so that  $-0.0 \leftarrow +0.0$ .

The FICOMP instructions pop the register stack following the comparison. To pop the register stack, the processor marks the ST(0) register empty and increments the stack pointer (TOP) by 1.

This instruction’s operation is the same in non-64-bit modes and 64-bit mode.

### Operation

CASE (relation of operands) OF

```

ST(0) > SRC:    C3, C2, C0 ← 000;
ST(0) < SRC:    C3, C2, C0 ← 001;
ST(0) = SRC:    C3, C2, C0 ← 100;
Unordered:      C3, C2, C0 ← 111;

```

ESAC;

IF Instruction = FICOMP

THEN

PopRegisterStack;

FI;

### FPU Flags Affected

C1                   Set to 0.  
C0, C2, C3           See table on previous page.

### Floating-Point Exceptions

#IS                   Stack underflow occurred.  
#IA                   One or both operands are NaN values or have unsupported formats.  
#D                   One or both operands are denormal values.

**Protected Mode Exceptions**

#GP(0)	If a memory operand effective address is outside the CS, DS, ES, FS, or GS segment limit. If the DS, ES, FS, or GS register contains a NULL segment selector.
#SS(0)	If a memory operand effective address is outside the SS segment limit.
#NM	CR0.EM[bit 2] or CR0.TS[bit 3] = 1.
#PF(fault-code)	If a page fault occurs.
#AC(0)	If alignment checking is enabled and an unaligned memory reference is made while the current privilege level is 3.
#UD	If the LOCK prefix is used.

**Real-Address Mode Exceptions**

#GP	If a memory operand effective address is outside the CS, DS, ES, FS, or GS segment limit.
#SS	If a memory operand effective address is outside the SS segment limit.
#NM	CR0.EM[bit 2] or CR0.TS[bit 3] = 1.
#UD	If the LOCK prefix is used.

**Virtual-8086 Mode Exceptions**

#GP(0)	If a memory operand effective address is outside the CS, DS, ES, FS, or GS segment limit.
#SS(0)	If a memory operand effective address is outside the SS segment limit.
#NM	CR0.EM[bit 2] or CR0.TS[bit 3] = 1.
#PF(fault-code)	If a page fault occurs.
#AC(0)	If alignment checking is enabled and an unaligned memory reference is made.
#UD	If the LOCK prefix is used.

**Compatibility Mode Exceptions**

Same exceptions as in protected mode.

**64-Bit Mode Exceptions**

#SS(0)	If a memory address referencing the SS segment is in a non-canonical form.
#GP(0)	If the memory address is in a non-canonical form.
#NM	CR0.EM[bit 2] or CR0.TS[bit 3] = 1.
#MF	If there is a pending x87 FPU exception.
#PF(fault-code)	If a page fault occurs.
#AC(0)	If alignment checking is enabled and an unaligned memory reference is made while the current privilege level is 3.
#UD	If the LOCK prefix is used.

## FILD—Load Integer

Opcode	Instruction	64-Bit Mode	Compat/ Leg Mode	Description
DF /0	FILD <i>m16int</i>	Valid	Valid	Push <i>m16int</i> onto the FPU register stack.
DB /0	FILD <i>m32int</i>	Valid	Valid	Push <i>m32int</i> onto the FPU register stack.
DF /5	FILD <i>m64int</i>	Valid	Valid	Push <i>m64int</i> onto the FPU register stack.

### Description

Converts the signed-integer source operand into double extended-precision floating-point format and pushes the value onto the FPU register stack. The source operand can be a word, doubleword, or quadword integer. It is loaded without rounding errors. The sign of the source operand is preserved.

This instruction's operation is the same in non-64-bit modes and 64-bit mode.

### Operation

TOP ← TOP – 1;

ST(0) ← ConvertToDoubleExtendedPrecisionFP(SRC);

### FPU Flags Affected

C1 Set to 1 if stack overflow occurred; set to 0 otherwise.

C0, C2, C3 Undefined.

### Floating-Point Exceptions

#IS Stack overflow occurred.

### Protected Mode Exceptions

#GP(0) If a memory operand effective address is outside the CS, DS, ES, FS, or GS segment limit.  
If the DS, ES, FS, or GS register contains a NULL segment selector.

#SS(0) If a memory operand effective address is outside the SS segment limit.

#NM CR0.EM[bit 2] or CR0.TS[bit 3] = 1.

#PF(fault-code) If a page fault occurs.

#AC(0) If alignment checking is enabled and an unaligned memory reference is made while the current privilege level is 3.

#UD If the LOCK prefix is used.

### Real-Address Mode Exceptions

#GP If a memory operand effective address is outside the CS, DS, ES, FS, or GS segment limit.

#SS If a memory operand effective address is outside the SS segment limit.

#NM CR0.EM[bit 2] or CR0.TS[bit 3] = 1.

#UD If the LOCK prefix is used.

### Virtual-8086 Mode Exceptions

#GP(0) If a memory operand effective address is outside the CS, DS, ES, FS, or GS segment limit.

#SS(0) If a memory operand effective address is outside the SS segment limit.

#NM CR0.EM[bit 2] or CR0.TS[bit 3] = 1.

#PF(fault-code) If a page fault occurs.

#AC(0) If alignment checking is enabled and an unaligned memory reference is made.

#UD If the LOCK prefix is used.



## Compatibility Mode Exceptions

Same exceptions as in protected mode.

## 64-Bit Mode Exceptions

#SS(0)	If a memory address referencing the SS segment is in a non-canonical form.
#GP(0)	If the memory address is in a non-canonical form.
#NM	CR0.EM[bit 2] or CR0.TS[bit 3] = 1.
#MF	If there is a pending x87 FPU exception.
#PF(fault-code)	If a page fault occurs.
#AC(0)	If alignment checking is enabled and an unaligned memory reference is made while the current privilege level is 3.
#UD	If the LOCK prefix is used.

## FINCSTP—Increment Stack-Top Pointer

Opcode	Instruction	64-Bit Mode	Compat/ Leg Mode	Description
D9 F7	FINCSTP	Valid	Valid	Increment the TOP field in the FPU status register.

### Description

Adds one to the TOP field of the FPU status word (increments the top-of-stack pointer). If the TOP field contains a 7, it is set to 0. The effect of this instruction is to rotate the stack by one position. The contents of the FPU data registers and tag register are not affected. This operation is not equivalent to popping the stack, because the tag for the previous top-of-stack register is not marked empty.

This instruction's operation is the same in non-64-bit modes and 64-bit mode.

### Operation

```
IF TOP = 7
  THEN TOP ← 0;
  ELSE TOP ← TOP + 1;
FI;
```

### FPU Flags Affected

The C1 flag is set to 0. The C0, C2, and C3 flags are undefined.

### Floating-Point Exceptions

None

### Protected Mode Exceptions

#NM CR0.EM[bit 2] or CR0.TS[bit 3] = 1.  
 #MF If there is a pending x87 FPU exception.  
 #UD If the LOCK prefix is used.

### Real-Address Mode Exceptions

Same exceptions as in protected mode.

### Virtual-8086 Mode Exceptions

Same exceptions as in protected mode.

### Compatibility Mode Exceptions

Same exceptions as in protected mode.

### 64-Bit Mode Exceptions

Same exceptions as in protected mode.

## FINIT/FNINIT—Initialize Floating-Point Unit

Opcode	Instruction	64-Bit Mode	Compat/Leg Mode	Description
9B DB E3	FINIT	Valid	Valid	Initialize FPU after checking for pending unmasked floating-point exceptions.
DB E3	FNINIT*	Valid	Valid	Initialize FPU without checking for pending unmasked floating-point exceptions.

### NOTES:

\* See IA-32 Architecture Compatibility section below.

### Description

Sets the FPU control, status, tag, instruction pointer, and data pointer registers to their default states. The FPU control word is set to 037FH (round to nearest, all exceptions masked, 64-bit precision). The status word is cleared (no exception flags set, TOP is set to 0). The data registers in the register stack are left unchanged, but they are all tagged as empty (11B). Both the instruction and data pointers are cleared.

The FINIT instruction checks for and handles any pending unmasked floating-point exceptions before performing the initialization; the FNINIT instruction does not.

The assembler issues two instructions for the FINIT instruction (an FWAIT instruction followed by an FNINIT instruction), and the processor executes each of these instructions separately. If an exception is generated for either of these instructions, the save EIP points to the instruction that caused the exception.

This instruction's operation is the same in non-64-bit modes and 64-bit mode.

### IA-32 Architecture Compatibility

When operating a Pentium or Intel486 processor in MS-DOS compatibility mode, it is possible (under unusual circumstances) for an FNINIT instruction to be interrupted prior to being executed to handle a pending FPU exception. See the section titled "No-Wait FPU Instructions Can Get FPU Interrupt in Window" in Appendix D of the *Intel® 64 and IA-32 Architectures Software Developer's Manual, Volume 1*, for a description of these circumstances. An FNINIT instruction cannot be interrupted in this way on later Intel processors, except for the Intel Quark™ X1000 processor.

In the Intel387 math coprocessor, the FINIT/FNINIT instruction does not clear the instruction and data pointers.

This instruction affects only the x87 FPU. It does not affect the XMM and MXCSR registers.

### Operation

```
FPUControlWord ← 037FH;
FPUStatusWord ← 0;
FPUTagWord ← FFFFH;
FPUDataPointer ← 0;
FPUInstructionPointer ← 0;
FPULastInstructionOpcode ← 0;
```

### FPU Flags Affected

C0, C1, C2, C3 set to 0.

### Floating-Point Exceptions

None

### Protected Mode Exceptions

- #NM CR0.EM[bit 2] or CR0.TS[bit 3] = 1.
- #MF If there is a pending x87 FPU exception.
- #UD If the LOCK prefix is used.

### Real-Address Mode Exceptions

Same exceptions as in protected mode.

### Virtual-8086 Mode Exceptions

Same exceptions as in protected mode.

### Compatibility Mode Exceptions

Same exceptions as in protected mode.

### 64-Bit Mode Exceptions

Same exceptions as in protected mode.

## FIST/FISTP—Store Integer

Opcode	Instruction	64-Bit Mode	Compat/Leg Mode	Description
DF /2	FIST <i>m16int</i>	Valid	Valid	Store ST(0) in <i>m16int</i> .
DB /2	FIST <i>m32int</i>	Valid	Valid	Store ST(0) in <i>m32int</i> .
DF /3	FISTP <i>m16int</i>	Valid	Valid	Store ST(0) in <i>m16int</i> and pop register stack.
DB /3	FISTP <i>m32int</i>	Valid	Valid	Store ST(0) in <i>m32int</i> and pop register stack.
DF /7	FISTP <i>m64int</i>	Valid	Valid	Store ST(0) in <i>m64int</i> and pop register stack.

### Description

The FIST instruction converts the value in the ST(0) register to a signed integer and stores the result in the destination operand. Values can be stored in word or doubleword integer format. The destination operand specifies the address where the first byte of the destination value is to be stored.

The FISTP instruction performs the same operation as the FIST instruction and then pops the register stack. To pop the register stack, the processor marks the ST(0) register as empty and increments the stack pointer (TOP) by 1. The FISTP instruction also stores values in quadword integer format.

The following table shows the results obtained when storing various classes of numbers in integer format.

**Table 3-27. FIST/FISTP Results**

ST(0)	DEST
$-\infty$ or Value Too Large for DEST Format	*
$F \leq -1$	-I
$-1 < F < -0$	**
-0	0
+0	0
$+0 < F < +1$	**
$F \geq +1$	+I
$+\infty$ or Value Too Large for DEST Format	*
NaN	*

**NOTES:**  
 F Means finite floating-point value.  
 I Means integer.  
 \* Indicates floating-point invalid-operation (#IA) exception.  
 \*\* 0 or  $\pm 1$ , depending on the rounding mode.

If the source value is a non-integral value, it is rounded to an integer value, according to the rounding mode specified by the RC field of the FPU control word.

If the converted value is too large for the destination format, or if the source operand is an  $\infty$ , SNaN, QNaN, or is in an unsupported format, an invalid-arithmetical-operand condition is signaled. If the invalid-operation exception is not masked, an invalid-arithmetical-operand exception (#IA) is generated and no value is stored in the destination operand. If the invalid-operation exception is masked, the integer indefinite value is stored in memory.

This instruction's operation is the same in non-64-bit modes and 64-bit mode.

**Operation**

DEST ← Integer(ST(0));

IF Instruction = FISTP  
 THEN  
   PopRegisterStack;  
 FI;

**FPU Flags Affected**

C1                   Set to 0 if stack underflow occurred.  
 Indicates rounding direction of if the inexact exception (#P) is generated: 0 ← not roundup; 1 ← roundup.  
 Set to 0 otherwise.

C0, C2, C3           Undefined.

**Floating-Point Exceptions**

#IS                   Stack underflow occurred.

#IA                   Converted value is too large for the destination format.  
 Source operand is an SNaN, QNaN,  $\pm\infty$ , or unsupported format.

#P                    Value cannot be represented exactly in destination format.

**Protected Mode Exceptions**

#GP(0)               If the destination is located in a non-writable segment.  
 If a memory operand effective address is outside the CS, DS, ES, FS, or GS segment limit.  
 If the DS, ES, FS, or GS register is used to access memory and it contains a NULL segment selector.

#SS(0)               If a memory operand effective address is outside the SS segment limit.

#NM                   CR0.EM[bit 2] or CR0.TS[bit 3] = 1.

#PF(fault-code)      If a page fault occurs.

#AC(0)               If alignment checking is enabled and an unaligned memory reference is made while the current privilege level is 3.

#UD                   If the LOCK prefix is used.

**Real-Address Mode Exceptions**

#GP                   If a memory operand effective address is outside the CS, DS, ES, FS, or GS segment limit.

#SS                   If a memory operand effective address is outside the SS segment limit.

#NM                   CR0.EM[bit 2] or CR0.TS[bit 3] = 1.

#UD                   If the LOCK prefix is used.

**Virtual-8086 Mode Exceptions**

#GP(0)               If a memory operand effective address is outside the CS, DS, ES, FS, or GS segment limit.

#SS(0)               If a memory operand effective address is outside the SS segment limit.

#NM                   CR0.EM[bit 2] or CR0.TS[bit 3] = 1.

#PF(fault-code)      If a page fault occurs.

#AC(0)               If alignment checking is enabled and an unaligned memory reference is made.

#UD                   If the LOCK prefix is used.

**Compatibility Mode Exceptions**

Same exceptions as in protected mode.

## 64-Bit Mode Exceptions

#SS(0)	If a memory address referencing the SS segment is in a non-canonical form.
#GP(0)	If the memory address is in a non-canonical form.
#NM	CR0.EM[bit 2] or CR0.TS[bit 3] = 1.
#MF	If there is a pending x87 FPU exception.
#PF(fault-code)	If a page fault occurs.
#AC(0)	If alignment checking is enabled and an unaligned memory reference is made while the current privilege level is 3.
#UD	If the LOCK prefix is used.

## FISTTP—Store Integer with Truncation

Opcode	Instruction	64-Bit Mode	Compat/ Leg Mode	Description
DF /1	FISTTP <i>m16int</i>	Valid	Valid	Store ST(0) in <i>m16int</i> with truncation.
DB /1	FISTTP <i>m32int</i>	Valid	Valid	Store ST(0) in <i>m32int</i> with truncation.
DD /1	FISTTP <i>m64int</i>	Valid	Valid	Store ST(0) in <i>m64int</i> with truncation.

### Description

FISTTP converts the value in ST into a signed integer using truncation (chop) as rounding mode, transfers the result to the destination, and pop ST. FISTTP accepts word, short integer, and long integer destinations.

The following table shows the results obtained when storing various classes of numbers in integer format.

**Table 3-28. FISTTP Results**

ST(0)	DEST
$-\infty$ or Value Too Large for DEST Format	*
$F \leq -1$	-I
$-1 < F < +1$	0
$F \geq +1$	+I
$+\infty$ or Value Too Large for DEST Format	*
NaN	*

#### NOTES:

F Means finite floating-point value.

I Means integer.

\* Indicates floating-point invalid-operation (#IA) exception.

This instruction's operation is the same in non-64-bit modes and 64-bit mode.

### Operation

DEST ← ST;

pop ST;

### Flags Affected

C1 is cleared; C0, C2, C3 undefined.

### Numeric Exceptions

Invalid, Stack Invalid (stack underflow), Precision.

### Protected Mode Exceptions

#GP(0)	If the destination is in a nonwritable segment.
	For an illegal memory operand effective address in the CS, DS, ES, FS or GS segments.
#SS(0)	For an illegal address in the SS segment.
#PF(fault-code)	For a page fault.
#AC(0)	If alignment checking is enabled and an unaligned memory reference is made while the current privilege level is 3.
#NM	If CR0.EM[bit 2] = 1. If CR0.TS[bit 3] = 1.
#UD	If CPUID.01H:ECX.SSE3[bit 0] = 0. If the LOCK prefix is used.



**Real Address Mode Exceptions**

GP(0)	If any part of the operand would lie outside of the effective address space from 0 to 0FFFFH.
#NM	If CR0.EM[bit 2] = 1. If CR0.TS[bit 3] = 1.
#UD	If CPUID.01H:ECX.SSE3[bit 0] = 0. If the LOCK prefix is used.

**Virtual 8086 Mode Exceptions**

GP(0)	If any part of the operand would lie outside of the effective address space from 0 to 0FFFFH.
#NM	If CR0.EM[bit 2] = 1. If CR0.TS[bit 3] = 1.
#UD	If CPUID.01H:ECX.SSE3[bit 0] = 0. If the LOCK prefix is used.
#PF(fault-code)	For a page fault.
#AC(0)	For unaligned memory reference if the current privilege is 3.

**Compatibility Mode Exceptions**

Same exceptions as in protected mode.

**64-Bit Mode Exceptions**

#SS(0)	If a memory address referencing the SS segment is in a non-canonical form.
#GP(0)	If the memory address is in a non-canonical form.
#NM	CR0.EM[bit 2] or CR0.TS[bit 3] = 1.
#MF	If there is a pending x87 FPU exception.
#PF(fault-code)	If a page fault occurs.
#AC(0)	If alignment checking is enabled and an unaligned memory reference is made while the current privilege level is 3. If the LOCK prefix is used.

## FLD—Load Floating Point Value

Opcode	Instruction	64-Bit Mode	Compat/ Leg Mode	Description
D9 /0	FLD <i>m32fp</i>	Valid	Valid	Push <i>m32fp</i> onto the FPU register stack.
DD /0	FLD <i>m64fp</i>	Valid	Valid	Push <i>m64fp</i> onto the FPU register stack.
DB /5	FLD <i>m80fp</i>	Valid	Valid	Push <i>m80fp</i> onto the FPU register stack.
D9 C0+i	FLD ST(i)	Valid	Valid	Push ST(i) onto the FPU register stack.

### Description

Pushes the source operand onto the FPU register stack. The source operand can be in single-precision, double-precision, or double extended-precision floating-point format. If the source operand is in single-precision or double-precision floating-point format, it is automatically converted to the double extended-precision floating-point format before being pushed on the stack.

The FLD instruction can also push the value in a selected FPU register [ST(i)] onto the stack. Here, pushing register ST(0) duplicates the stack top.

This instruction's operation is the same in non-64-bit modes and 64-bit mode.

### Operation

IF SRC is ST(i)

THEN

temp ← ST(i);

FI;

TOP ← TOP – 1;

IF SRC is memory-operand

THEN

ST(0) ← ConvertToDoubleExtendedPrecisionFP(SRC);

ELSE (\* SRC is ST(i) \*)

ST(0) ← temp;

FI;

### FPU Flags Affected

C1 Set to 1 if stack overflow occurred; otherwise, set to 0.

C0, C2, C3 Undefined.

### Floating-Point Exceptions

#IS Stack underflow or overflow occurred.

#IA Source operand is an SNaN. Does not occur if the source operand is in double extended-precision floating-point format (FLD *m80fp* or FLD ST(i)).

#D Source operand is a denormal value. Does not occur if the source operand is in double extended-precision floating-point format.

**Protected Mode Exceptions**

#GP(0)	If destination is located in a non-writable segment. If a memory operand effective address is outside the CS, DS, ES, FS, or GS segment limit. If the DS, ES, FS, or GS register is used to access memory and it contains a NULL segment selector.
#SS(0)	If a memory operand effective address is outside the SS segment limit.
#NM	CR0.EM[bit 2] or CR0.TS[bit 3] = 1.
#PF(fault-code)	If a page fault occurs.
#AC(0)	If alignment checking is enabled and an unaligned memory reference is made while the current privilege level is 3.
#UD	If the LOCK prefix is used.

**Real-Address Mode Exceptions**

#GP	If a memory operand effective address is outside the CS, DS, ES, FS, or GS segment limit.
#SS	If a memory operand effective address is outside the SS segment limit.
#NM	CR0.EM[bit 2] or CR0.TS[bit 3] = 1.
#UD	If the LOCK prefix is used.

**Virtual-8086 Mode Exceptions**

#GP(0)	If a memory operand effective address is outside the CS, DS, ES, FS, or GS segment limit.
#SS(0)	If a memory operand effective address is outside the SS segment limit.
#NM	CR0.EM[bit 2] or CR0.TS[bit 3] = 1.
#PF(fault-code)	If a page fault occurs.
#AC(0)	If alignment checking is enabled and an unaligned memory reference is made.
#UD	If the LOCK prefix is used.

**Compatibility Mode Exceptions**

Same exceptions as in protected mode.

**64-Bit Mode Exceptions**

#SS(0)	If a memory address referencing the SS segment is in a non-canonical form.
#GP(0)	If the memory address is in a non-canonical form.
#NM	CR0.EM[bit 2] or CR0.TS[bit 3] = 1.
#MF	If there is a pending x87 FPU exception.
#PF(fault-code)	If a page fault occurs.
#AC(0)	If alignment checking is enabled and an unaligned memory reference is made while the current privilege level is 3.
#UD	If the LOCK prefix is used.

## FLD1/FLDL2T/FLDL2E/FLDPI/FLDLG2/FLDLN2/FLDZ—Load Constant

Opcode*	Instruction	64-Bit Mode	Compat/ Leg Mode	Description
D9 E8	FLD1	Valid	Valid	Push +1.0 onto the FPU register stack.
D9 E9	FLDL2T	Valid	Valid	Push $\log_2 10$ onto the FPU register stack.
D9 EA	FLDL2E	Valid	Valid	Push $\log_2 e$ onto the FPU register stack.
D9 EB	FLDPI	Valid	Valid	Push $\pi$ onto the FPU register stack.
D9 EC	FLDLG2	Valid	Valid	Push $\log_{10} 2$ onto the FPU register stack.
D9 ED	FLDLN2	Valid	Valid	Push $\log_e 2$ onto the FPU register stack.
D9 EE	FLDZ	Valid	Valid	Push +0.0 onto the FPU register stack.

### NOTES:

\* See IA-32 Architecture Compatibility section below.

### Description

Push one of seven commonly used constants (in double extended-precision floating-point format) onto the FPU register stack. The constants that can be loaded with these instructions include +1.0, +0.0,  $\log_2 10$ ,  $\log_2 e$ ,  $\pi$ ,  $\log_{10} 2$ , and  $\log_e 2$ . For each constant, an internal 66-bit constant is rounded (as specified by the RC field in the FPU control word) to double extended-precision floating-point format. The inexact-result exception (#P) is not generated as a result of the rounding, nor is the C1 flag set in the x87 FPU status word if the value is rounded up.

See the section titled "Approximation of Pi" in Chapter 8 of the *Intel® 64 and IA-32 Architectures Software Developer's Manual, Volume 1*, for a description of the  $\pi$  constant.

This instruction's operation is the same in non-64-bit modes and 64-bit mode.

### IA-32 Architecture Compatibility

When the RC field is set to round-to-nearest, the FPU produces the same constants that is produced by the Intel 8087 and Intel 287 math coprocessors.

### Operation

TOP  $\leftarrow$  TOP – 1;  
ST(0)  $\leftarrow$  CONSTANT;

### FPU Flags Affected

C1 Set to 1 if stack overflow occurred; otherwise, set to 0.  
C0, C2, C3 Undefined.

### Floating-Point Exceptions

#IS Stack overflow occurred.

### Protected Mode Exceptions

#NM CR0.EM[bit 2] or CR0.TS[bit 3] = 1.  
#MF If there is a pending x87 FPU exception.  
#UD If the LOCK prefix is used.

### Real-Address Mode Exceptions

Same exceptions as in protected mode.

### Virtual-8086 Mode Exceptions

Same exceptions as in protected mode.

**Virtual-8086 Mode Exceptions**

Same exceptions as in protected mode.

**Compatibility Mode Exceptions**

Same exceptions as in protected mode.

**64-Bit Mode Exceptions**

Same exceptions as in protected mode.

## FLDCW—Load x87 FPU Control Word

Opcode	Instruction	64-Bit Mode	Compat/ Leg Mode	Description
D9 /5	FLDCW <i>m2byte</i>	Valid	Valid	Load FPU control word from <i>m2byte</i> .

### Description

Loads the 16-bit source operand into the FPU control word. The source operand is a memory location. This instruction is typically used to establish or change the FPU's mode of operation.

If one or more exception flags are set in the FPU status word prior to loading a new FPU control word and the new control word unmask one or more of those exceptions, a floating-point exception will be generated upon execution of the next floating-point instruction (except for the no-wait floating-point instructions, see the section titled "Software Exception Handling" in Chapter 8 of the *Intel® 64 and IA-32 Architectures Software Developer's Manual, Volume 1*). To avoid raising exceptions when changing FPU operating modes, clear any pending exceptions (using the FCLEX or FNCLEX instruction) before loading the new control word.

This instruction's operation is the same in non-64-bit modes and 64-bit mode.

### Operation

FPUControlWord ← SRC;

### FPU Flags Affected

C0, C1, C2, C3 undefined.

### Floating-Point Exceptions

None; however, this operation might unmask a pending exception in the FPU status word. That exception is then generated upon execution of the next "waiting" floating-point instruction.

### Protected Mode Exceptions

#GP(0)	If a memory operand effective address is outside the CS, DS, ES, FS, or GS segment limit. If the DS, ES, FS, or GS register is used to access memory and it contains a NULL segment selector.
#SS(0)	If a memory operand effective address is outside the SS segment limit.
#NM	CR0.EM[bit 2] or CR0.TS[bit 3] = 1.
#PF(fault-code)	If a page fault occurs.
#AC(0)	If alignment checking is enabled and an unaligned memory reference is made while the current privilege level is 3.
#UD	If the LOCK prefix is used.

### Real-Address Mode Exceptions

#GP	If a memory operand effective address is outside the CS, DS, ES, FS, or GS segment limit.
#SS	If a memory operand effective address is outside the SS segment limit.
#NM	CR0.EM[bit 2] or CR0.TS[bit 3] = 1.
#UD	If the LOCK prefix is used.

**Virtual-8086 Mode Exceptions**

#GP(0)	If a memory operand effective address is outside the CS, DS, ES, FS, or GS segment limit.
#SS(0)	If a memory operand effective address is outside the SS segment limit.
#NM	CR0.EM[bit 2] or CR0.TS[bit 3] = 1.
#PF(fault-code)	If a page fault occurs.
#AC(0)	If alignment checking is enabled and an unaligned memory reference is made.
#UD	If the LOCK prefix is used.

**Compatibility Mode Exceptions**

Same exceptions as in protected mode.

**64-Bit Mode Exceptions**

#SS(0)	If a memory address referencing the SS segment is in a non-canonical form.
#GP(0)	If the memory address is in a non-canonical form.
#NM	CR0.EM[bit 2] or CR0.TS[bit 3] = 1.
#MF	If there is a pending x87 FPU exception.
#PF(fault-code)	If a page fault occurs.
#AC(0)	If alignment checking is enabled and an unaligned memory reference is made while the current privilege level is 3.
#UD	If the LOCK prefix is used.

## FLDENV—Load x87 FPU Environment

Opcode	Instruction	64-Bit Mode	Compat/Leg Mode	Description
D9 /4	FLDENV <i>m14/28byte</i>	Valid	Valid	Load FPU environment from <i>m14byte</i> or <i>m28byte</i> .

### Description

Loads the complete x87 FPU operating environment from memory into the FPU registers. The source operand specifies the first byte of the operating-environment data in memory. This data is typically written to the specified memory location by a FSTENV or FNSTENV instruction.

The FPU operating environment consists of the FPU control word, status word, tag word, instruction pointer, data pointer, and last opcode. Figures 8-9 through 8-12 in the *Intel® 64 and IA-32 Architectures Software Developer's Manual, Volume 1*, show the layout in memory of the loaded environment, depending on the operating mode of the processor (protected or real) and the current operand-size attribute (16-bit or 32-bit). In virtual-8086 mode, the real mode layouts are used.

The FLDENV instruction should be executed in the same operating mode as the corresponding FSTENV/FNSTENV instruction.

If one or more unmasked exception flags are set in the new FPU status word, a floating-point exception will be generated upon execution of the next floating-point instruction (except for the no-wait floating-point instructions, see the section titled "Software Exception Handling" in Chapter 8 of the *Intel® 64 and IA-32 Architectures Software Developer's Manual, Volume 1*). To avoid generating exceptions when loading a new environment, clear all the exception flags in the FPU status word that is being loaded.

If a page or limit fault occurs during the execution of this instruction, the state of the x87 FPU registers as seen by the fault handler may be different than the state being loaded from memory. In such situations, the fault handler should ignore the status of the x87 FPU registers, handle the fault, and return. The FLDENV instruction will then complete the loading of the x87 FPU registers with no resulting context inconsistency.

This instruction's operation is the same in non-64-bit modes and 64-bit mode.

### Operation

```

FPUControlWord ← SRC[FPUControlWord];
FPUStatusWord ← SRC[FPUStatusWord];
FPUTagWord ← SRC[FPUTagWord];
FPUDataPointer ← SRC[FPUDataPointer];
FPUInstructionPointer ← SRC[FPUInstructionPointer];
FPULastInstructionOpcode ← SRC[FPULastInstructionOpcode];

```

### FPU Flags Affected

The C0, C1, C2, C3 flags are loaded.

### Floating-Point Exceptions

None; however, if an unmasked exception is loaded in the status word, it is generated upon execution of the next "waiting" floating-point instruction.



**Protected Mode Exceptions**

#GP(0)	If a memory operand effective address is outside the CS, DS, ES, FS, or GS segment limit. If the DS, ES, FS, or GS register is used to access memory and it contains a NULL segment selector.
#SS(0)	If a memory operand effective address is outside the SS segment limit.
#NM	CR0.EM[bit 2] or CR0.TS[bit 3] = 1.
#PF(fault-code)	If a page fault occurs.
#AC(0)	If alignment checking is enabled and an unaligned memory reference is made while the current privilege level is 3.
#UD	If the LOCK prefix is used.

**Real-Address Mode Exceptions**

#GP	If a memory operand effective address is outside the CS, DS, ES, FS, or GS segment limit.
#SS	If a memory operand effective address is outside the SS segment limit.
#NM	CR0.EM[bit 2] or CR0.TS[bit 3] = 1.
#UD	If the LOCK prefix is used.

**Virtual-8086 Mode Exceptions**

#GP(0)	If a memory operand effective address is outside the CS, DS, ES, FS, or GS segment limit.
#SS(0)	If a memory operand effective address is outside the SS segment limit.
#NM	CR0.EM[bit 2] or CR0.TS[bit 3] = 1.
#PF(fault-code)	If a page fault occurs.
#AC(0)	If alignment checking is enabled and an unaligned memory reference is made.
#UD	If the LOCK prefix is used.

**Compatibility Mode Exceptions**

Same exceptions as in protected mode.

**64-Bit Mode Exceptions**

#SS(0)	If a memory address referencing the SS segment is in a non-canonical form.
#GP(0)	If the memory address is in a non-canonical form.
#NM	CR0.EM[bit 2] or CR0.TS[bit 3] = 1.
#MF	If there is a pending x87 FPU exception.
#PF(fault-code)	If a page fault occurs.
#AC(0)	If alignment checking is enabled and an unaligned memory reference is made while the current privilege level is 3.
#UD	If the LOCK prefix is used.

## FMUL/FMULP/FIMUL—Multiply

Opcode	Instruction	64-Bit Mode	Compat/ Leg Mode	Description
D8 /1	FMUL <i>m32fp</i>	Valid	Valid	Multiply ST(0) by <i>m32fp</i> and store result in ST(0).
DC /1	FMUL <i>m64fp</i>	Valid	Valid	Multiply ST(0) by <i>m64fp</i> and store result in ST(0).
D8 C8+i	FMUL ST(0), ST(i)	Valid	Valid	Multiply ST(0) by ST(i) and store result in ST(0).
DC C8+i	FMUL ST(i), ST(0)	Valid	Valid	Multiply ST(i) by ST(0) and store result in ST(i).
DE C8+i	FMULP ST(i), ST(0)	Valid	Valid	Multiply ST(i) by ST(0), store result in ST(i), and pop the register stack.
DE C9	FMULP	Valid	Valid	Multiply ST(1) by ST(0), store result in ST(1), and pop the register stack.
DA /1	FIMUL <i>m32int</i>	Valid	Valid	Multiply ST(0) by <i>m32int</i> and store result in ST(0).
DE /1	FIMUL <i>m16int</i>	Valid	Valid	Multiply ST(0) by <i>m16int</i> and store result in ST(0).

### Description

Multiplies the destination and source operands and stores the product in the destination location. The destination operand is always an FPU data register; the source operand can be an FPU data register or a memory location. Source operands in memory can be in single-precision or double-precision floating-point format or in word or doubleword integer format.

The no-operand version of the instruction multiplies the contents of the ST(1) register by the contents of the ST(0) register and stores the product in the ST(1) register. The one-operand version multiplies the contents of the ST(0) register by the contents of a memory location (either a floating point or an integer value) and stores the product in the ST(0) register. The two-operand version, multiplies the contents of the ST(0) register by the contents of the ST(i) register, or vice versa, with the result being stored in the register specified with the first operand (the destination operand).

The FMULP instructions perform the additional operation of popping the FPU register stack after storing the product. To pop the register stack, the processor marks the ST(0) register as empty and increments the stack pointer (TOP) by 1. The no-operand version of the floating-point multiply instructions always results in the register stack being popped. In some assemblers, the mnemonic for this instruction is FMUL rather than FMULP.

The FIMUL instructions convert an integer source operand to double extended-precision floating-point format before performing the multiplication.

The sign of the result is always the exclusive-OR of the source signs, even if one or more of the values being multiplied is 0 or  $\infty$ . When the source operand is an integer 0, it is treated as a +0.

The following table shows the results obtained when multiplying various classes of numbers, assuming that neither overflow nor underflow occurs.

Table 3-29. FMUL/FMULP/FIMUL Results

		DEST						
		$-\infty$	$-F$	$-0$	$+0$	$+F$	$+\infty$	
SRC	$-\infty$	$+\infty$	$+\infty$	*	*	$-\infty$	$-\infty$	NaN
	$-F$	$+\infty$	$+F$	$+0$	$-0$	$-F$	$-\infty$	NaN
	$-I$	$+\infty$	$+F$	$+0$	$-0$	$-F$	$-\infty$	NaN
	$-0$	*	$+0$	$+0$	$-0$	$-0$	*	NaN
	$+0$	*	$-0$	$-0$	$+0$	$+0$	*	NaN
	$+I$	$-\infty$	$-F$	$-0$	$+0$	$+F$	$+\infty$	NaN
	$+F$	$-\infty$	$-F$	$-0$	$+0$	$+F$	$+\infty$	NaN
	$+\infty$	$-\infty$	$-\infty$	*	*	$+\infty$	$+\infty$	NaN
	NaN	NaN	NaN	NaN	NaN	NaN	NaN	NaN

**NOTES:**

F Means finite floating-point value.

I Means Integer.

\* Indicates invalid-arithmetical-operand (#IA) exception.

This instruction's operation is the same in non-64-bit modes and 64-bit mode.

**Operation**

IF Instruction = FIMUL

THEN

DEST  $\leftarrow$  DEST \* ConvertToDoubleExtendedPrecisionFP(SRC);

ELSE (\* Source operand is floating-point value \*)

DEST  $\leftarrow$  DEST \* SRC;

FI;

IF Instruction = FMULP

THEN

PopRegisterStack;

FI;

**FPU Flags Affected**

- C1 Set to 0 if stack underflow occurred.  
Set if result was rounded up; cleared otherwise.
- C0, C2, C3 Undefined.

**Floating-Point Exceptions**

- #IS Stack underflow occurred.
- #IA Operand is an SNaN value or unsupported format.  
One operand is  $\pm 0$  and the other is  $\pm \infty$ .
- #D Source operand is a denormal value.
- #U Result is too small for destination format.
- #O Result is too large for destination format.
- #P Value cannot be represented exactly in destination format.

**Protected Mode Exceptions**

#GP(0)	If a memory operand effective address is outside the CS, DS, ES, FS, or GS segment limit. If the DS, ES, FS, or GS register is used to access memory and it contains a NULL segment selector.
#SS(0)	If a memory operand effective address is outside the SS segment limit.
#NM	CR0.EM[bit 2] or CR0.TS[bit 3] = 1.
#PF(fault-code)	If a page fault occurs.
#AC(0)	If alignment checking is enabled and an unaligned memory reference is made while the current privilege level is 3.
#UD	If the LOCK prefix is used.

**Real-Address Mode Exceptions**

#GP	If a memory operand effective address is outside the CS, DS, ES, FS, or GS segment limit.
#SS	If a memory operand effective address is outside the SS segment limit.
#NM	CR0.EM[bit 2] or CR0.TS[bit 3] = 1.
#UD	If the LOCK prefix is used.

**Virtual-8086 Mode Exceptions**

#GP(0)	If a memory operand effective address is outside the CS, DS, ES, FS, or GS segment limit.
#SS(0)	If a memory operand effective address is outside the SS segment limit.
#NM	CR0.EM[bit 2] or CR0.TS[bit 3] = 1.
#PF(fault-code)	If a page fault occurs.
#AC(0)	If alignment checking is enabled and an unaligned memory reference is made.
#UD	If the LOCK prefix is used.

**Compatibility Mode Exceptions**

Same exceptions as in protected mode.

**64-Bit Mode Exceptions**

#SS(0)	If a memory address referencing the SS segment is in a non-canonical form.
#GP(0)	If the memory address is in a non-canonical form.
#NM	CR0.EM[bit 2] or CR0.TS[bit 3] = 1.
#MF	If there is a pending x87 FPU exception.
#PF(fault-code)	If a page fault occurs.
#AC(0)	If alignment checking is enabled and an unaligned memory reference is made while the current privilege level is 3.
#UD	If the LOCK prefix is used.

## FNOP—No Operation

Opcode	Instruction	64-Bit Mode	Compat/ Leg Mode	Description
D9 D0	FNOP	Valid	Valid	No operation is performed.

### Description

Performs no FPU operation. This instruction takes up space in the instruction stream but does not affect the FPU or machine context, except the EIP register and the FPU Instruction Pointer.

This instruction's operation is the same in non-64-bit modes and 64-bit mode.

### FPU Flags Affected

C0, C1, C2, C3 undefined.

### Floating-Point Exceptions

None

### Protected Mode Exceptions

#NM CR0.EM[bit 2] or CR0.TS[bit 3] = 1.  
 #MF If there is a pending x87 FPU exception.  
 #UD If the LOCK prefix is used.

### Real-Address Mode Exceptions

Same exceptions as in protected mode.

### Virtual-8086 Mode Exceptions

Same exceptions as in protected mode.

### Compatibility Mode Exceptions

Same exceptions as in protected mode.

### 64-Bit Mode Exceptions

Same exceptions as in protected mode.

## FPATAN—Partial Arctangent

Opcode*	Instruction	64-Bit Mode	Compat/ Leg Mode	Description
D9 F3	FPATAN	Valid	Valid	Replace ST(1) with $\arctan(\text{ST}(1)/\text{ST}(0))$ and pop the register stack.

NOTES:

\* See IA-32 Architecture Compatibility section below.

### Description

Computes the arctangent of the source operand in register ST(1) divided by the source operand in register ST(0), stores the result in ST(1), and pops the FPU register stack. The result in register ST(0) has the same sign as the source operand ST(1) and a magnitude less than  $+\pi$ .

The FPATAN instruction returns the angle between the X axis and the line from the origin to the point (X,Y), where Y (the ordinate) is ST(1) and X (the abscissa) is ST(0). The angle depends on the sign of X and Y independently, not just on the sign of the ratio Y/X. This is because a point (-X,Y) is in the second quadrant, resulting in an angle between  $\pi/2$  and  $\pi$ , while a point (X,-Y) is in the fourth quadrant, resulting in an angle between 0 and  $-\pi/2$ . A point (-X,-Y) is in the third quadrant, giving an angle between  $-\pi/2$  and  $-\pi$ .

The following table shows the results obtained when computing the arctangent of various classes of numbers, assuming that underflow does not occur.

**Table 3-30. FPATAN Results**

		ST(0)						NaN
		$-\infty$	-F	-0	+0	+F	$+\infty$	
ST(1)	$-\infty$	$-3\pi/4^*$	$-\pi/2$	$-\pi/2$	$-\pi/2$	$-\pi/2$	$-\pi/4^*$	NaN
	-F	-p	$-\pi$ to $-\pi/2$	$-\pi/2$	$-\pi/2$	$-\pi/2$ to -0	-0	NaN
	-0	-p	-p	$-p^*$	$-0^*$	-0	-0	NaN
	+0	+p	+p	$+\pi^*$	$+0^*$	+0	+0	NaN
	+F	+p	$+\pi$ to $+\pi/2$	$+\pi/2$	$+\pi/2$	$+\pi/2$ to +0	+0	NaN
	$+\infty$	$+3\pi/4^*$	$+\pi/2$	$+\pi/2$	$+\pi/2$	$+\pi/2$	$+\pi/4^*$	NaN
	NaN	NaN	NaN	NaN	NaN	NaN	NaN	NaN

NOTES:

F Means finite floating-point value.

\* Table 8-10 in the *Intel® 64 and IA-32 Architectures Software Developer’s Manual, Volume 1*, specifies that the ratios 0/0 and  $\infty/\infty$  generate the floating-point invalid arithmetic-operation exception and, if this exception is masked, the floating-point QNaN indefinite value is returned. With the FPATAN instruction, the 0/0 or  $\infty/\infty$  value is actually not calculated using division. Instead, the arctangent of the two variables is derived from a standard mathematical formulation that is generalized to allow complex numbers as arguments. In this complex variable formulation,  $\arctan(0,0)$  etc. has well defined values. These values are needed to develop a library to compute transcendental functions with complex arguments, based on the FPU functions that only allow floating-point values as arguments.

There is no restriction on the range of source operands that FPATAN can accept.

This instruction’s operation is the same in non-64-bit modes and 64-bit mode.

### IA-32 Architecture Compatibility

The source operands for this instruction are restricted for the 80287 math coprocessor to the following range:

$$0 \leq |\text{ST}(1)| < |\text{ST}(0)| < +\infty$$

**Operation**

$ST(1) \leftarrow \arctan(ST(1) / ST(0));$   
 PopRegisterStack;

**FPU Flags Affected**

C1                      Set to 0 if stack underflow occurred.  
                           Set if result was rounded up; cleared otherwise.  
 C0, C2, C3            Undefined.

**Floating-Point Exceptions**

#IS                     Stack underflow occurred.  
 #IA                    Source operand is an SNaN value or unsupported format.  
 #D                     Source operand is a denormal value.  
 #U                     Result is too small for destination format.  
 #P                     Value cannot be represented exactly in destination format.

**Protected Mode Exceptions**

#NM                    CR0.EM[bit 2] or CR0.TS[bit 3] = 1.  
 #MF                    If there is a pending x87 FPU exception.  
 #UD                    If the LOCK prefix is used.

**Real-Address Mode Exceptions**

Same exceptions as in protected mode.

**Virtual-8086 Mode Exceptions**

Same exceptions as in protected mode.

**Compatibility Mode Exceptions**

Same exceptions as in protected mode.

**64-Bit Mode Exceptions**

Same exceptions as in protected mode.

## FPREM—Partial Remainder

Opcode	Instruction	64-Bit Mode	Compat/ Leg Mode	Description
D9 F8	FPREM	Valid	Valid	Replace ST(0) with the remainder obtained from dividing ST(0) by ST(1).

### Description

Computes the remainder obtained from dividing the value in the ST(0) register (the dividend) by the value in the ST(1) register (the divisor or **modulus**), and stores the result in ST(0). The remainder represents the following value:

$$\text{Remainder} \leftarrow \text{ST}(0) - (Q * \text{ST}(1))$$

Here, Q is an integer value that is obtained by truncating the floating-point number quotient of [ST(0) / ST(1)] toward zero. The sign of the remainder is the same as the sign of the dividend. The magnitude of the remainder is less than that of the modulus, unless a partial remainder was computed (as described below).

This instruction produces an exact result; the inexact-result exception does not occur and the rounding control has no effect. The following table shows the results obtained when computing the remainder of various classes of numbers, assuming that underflow does not occur.

**Table 3-31. FPREM Results**

		ST(1)						NaN
		$-\infty$	-F	-0	+0	+F	$+\infty$	
ST(0)	$-\infty$	*	*	*	*	*	*	NaN
	-F	ST(0)	-F or -0	**	**	-F or -0	ST(0)	NaN
	-0	-0	-0	*	*	-0	-0	NaN
	+0	+0	+0	*	*	+0	+0	NaN
	+F	ST(0)	+F or +0	**	**	+F or +0	ST(0)	NaN
	$+\infty$	*	*	*	*	*	*	NaN
	NaN	NaN	NaN	NaN	NaN	NaN	NaN	NaN

#### NOTES:

F Means finite floating-point value.

\* Indicates floating-point invalid-arithmetic-operand (#IA) exception.

\*\* Indicates floating-point zero-divide (#Z) exception.

When the result is 0, its sign is the same as that of the dividend. When the modulus is  $\infty$ , the result is equal to the value in ST(0).

The FPREM instruction does not compute the remainder specified in IEEE Std 754. The IEEE specified remainder can be computed with the FPREM1 instruction. The FPREM instruction is provided for compatibility with the Intel 8087 and Intel287 math coprocessors.

The FPREM instruction gets its name “partial remainder” because of the way it computes the remainder. This instruction arrives at a remainder through iterative subtraction. It can, however, reduce the exponent of ST(0) by no more than 63 in one execution of the instruction. If the instruction succeeds in producing a remainder that is less than the modulus, the operation is complete and the C2 flag in the FPU status word is cleared. Otherwise, C2 is set, and the result in ST(0) is called the **partial remainder**. The exponent of the partial remainder will be less than the exponent of the original dividend by at least 32. Software can re-execute the instruction (using the partial remainder in ST(0) as the dividend) until C2 is cleared. (Note that while executing such a remainder-computation loop, a higher-priority interrupting routine that needs the FPU can force a context switch in-between the instructions in the loop.)

An important use of the FPREM instruction is to reduce the arguments of periodic functions. When reduction is complete, the instruction stores the three least-significant bits of the quotient in the C3, C1, and C0 flags of the FPU



status word. This information is important in argument reduction for the tangent function (using a modulus of  $\pi/4$ ), because it locates the original angle in the correct one of eight sectors of the unit circle.

This instruction's operation is the same in non-64-bit modes and 64-bit mode.

### Operation

```

D ← exponent(ST(0)) - exponent(ST(1));
IF D < 64
  THEN
    Q ← Integer(TruncateTowardZero(ST(0) / ST(1)));
    ST(0) ← ST(0) - (ST(1) * Q);
    C2 ← 0;
    C0, C3, C1 ← LeastSignificantBits(Q); (* Q2, Q1, Q0 *)
  ELSE
    C2 ← 1;
    N ← An implementation-dependent number between 32 and 63;
    QQ ← Integer(TruncateTowardZero((ST(0) / ST(1)) / 2(D-N)));
    ST(0) ← ST(0) - (ST(1) * QQ * 2(D-N));
FI;

```

### FPU Flags Affected

C0	Set to bit 2 (Q2) of the quotient.
C1	Set to 0 if stack underflow occurred; otherwise, set to least significant bit of quotient (Q0).
C2	Set to 0 if reduction complete; set to 1 if incomplete.
C3	Set to bit 1 (Q1) of the quotient.

### Floating-Point Exceptions

#IS	Stack underflow occurred.
#IA	Source operand is an SNaN value, modulus is 0, dividend is $\infty$ , or unsupported format.
#D	Source operand is a denormal value.
#U	Result is too small for destination format.

### Protected Mode Exceptions

#NM	CR0.EM[bit 2] or CR0.TS[bit 3] = 1.
#MF	If there is a pending x87 FPU exception.
#UD	If the LOCK prefix is used.

### Real-Address Mode Exceptions

Same exceptions as in protected mode.

### Virtual-8086 Mode Exceptions

Same exceptions as in protected mode.

### Compatibility Mode Exceptions

Same exceptions as in protected mode.

### 64-Bit Mode Exceptions

Same exceptions as in protected mode.

## FPREM1—Partial Remainder

Opcode	Instruction	64-Bit Mode	Compat/ Leg Mode	Description
D9 F5	FPREM1	Valid	Valid	Replace ST(0) with the IEEE remainder obtained from dividing ST(0) by ST(1).

### Description

Computes the IEEE remainder obtained from dividing the value in the ST(0) register (the dividend) by the value in the ST(1) register (the divisor or modulus), and stores the result in ST(0). The remainder represents the following value:

$$\text{Remainder} \leftarrow \text{ST}(0) - (Q * \text{ST}(1))$$

Here, Q is an integer value that is obtained by rounding the floating-point number quotient of [ST(0) / ST(1)] toward the nearest integer value. The magnitude of the remainder is less than or equal to half the magnitude of the modulus, unless a partial remainder was computed (as described below).

This instruction produces an exact result; the precision (inexact) exception does not occur and the rounding control has no effect. The following table shows the results obtained when computing the remainder of various classes of numbers, assuming that underflow does not occur.

**Table 3-32. FPREM1 Results**

		ST(1)						NaN
		$-\infty$	-F	-0	+0	+F	$+\infty$	
ST(0)	$-\infty$	*	*	*	*	*	*	NaN
	-F	ST(0)	$\pm F$ or -0	**	**	$\pm F$ or -0	ST(0)	NaN
	-0	-0	-0	*	*	-0	-0	NaN
	+0	+0	+0	*	*	+0	+0	NaN
	+F	ST(0)	$\pm F$ or +0	**	**	$\pm F$ or +0	ST(0)	NaN
	$+\infty$	*	*	*	*	*	*	NaN
	NaN	NaN	NaN	NaN	NaN	NaN	NaN	NaN

#### NOTES:

F Means finite floating-point value.

\* Indicates floating-point invalid-arithmetic-operand (#IA) exception.

\*\* Indicates floating-point zero-divide (#Z) exception.

When the result is 0, its sign is the same as that of the dividend. When the modulus is  $\infty$ , the result is equal to the value in ST(0).

The FPREM1 instruction computes the remainder specified in IEEE Standard 754. This instruction operates differently from the FPREM instruction in the way that it rounds the quotient of ST(0) divided by ST(1) to an integer (see the "Operation" section below).

Like the FPREM instruction, FPREM1 computes the remainder through iterative subtraction, but can reduce the exponent of ST(0) by no more than 63 in one execution of the instruction. If the instruction succeeds in producing a remainder that is less than one half the modulus, the operation is complete and the C2 flag in the FPU status word is cleared. Otherwise, C2 is set, and the result in ST(0) is called the **partial remainder**. The exponent of the partial remainder will be less than the exponent of the original dividend by at least 32. Software can re-execute the instruction (using the partial remainder in ST(0) as the dividend) until C2 is cleared. (Note that while executing such a remainder-computation loop, a higher-priority interrupting routine that needs the FPU can force a context switch in-between the instructions in the loop.)

An important use of the FPREM1 instruction is to reduce the arguments of periodic functions. When reduction is complete, the instruction stores the three least-significant bits of the quotient in the C3, C1, and C0 flags of the FPU

status word. This information is important in argument reduction for the tangent function (using a modulus of  $\pi/4$ ), because it locates the original angle in the correct one of eight sectors of the unit circle.

This instruction's operation is the same in non-64-bit modes and 64-bit mode.

### Operation

```

D ← exponent(ST(0)) - exponent(ST(1));
IF D < 64
  THEN
    Q ← Integer(RoundTowardNearestInteger(ST(0) / ST(1)));
    ST(0) ← ST(0) - (ST(1) * Q);
    C2 ← 0;
    C0, C3, C1 ← LeastSignificantBits(Q); (* Q2, Q1, Q0 *)
  ELSE
    C2 ← 1;
    N ← An implementation-dependent number between 32 and 63;
    QQ ← Integer(TruncateTowardZero((ST(0) / ST(1)) / 2(D-N)));
    ST(0) ← ST(0) - (ST(1) * QQ * 2(D-N));
FI;

```

### FPU Flags Affected

C0	Set to bit 2 (Q2) of the quotient.
C1	Set to 0 if stack underflow occurred; otherwise, set to least significant bit of quotient (Q0).
C2	Set to 0 if reduction complete; set to 1 if incomplete.
C3	Set to bit 1 (Q1) of the quotient.

### Floating-Point Exceptions

#IS	Stack underflow occurred.
#IA	Source operand is an SNaN value, modulus (divisor) is 0, dividend is $\infty$ , or unsupported format.
#D	Source operand is a denormal value.
#U	Result is too small for destination format.

### Protected Mode Exceptions

#NM	CR0.EM[bit 2] or CR0.TS[bit 3] = 1.
#MF	If there is a pending x87 FPU exception.
#UD	If the LOCK prefix is used.

### Real-Address Mode Exceptions

Same exceptions as in protected mode.

### Virtual-8086 Mode Exceptions

Same exceptions as in protected mode.

### Compatibility Mode Exceptions

Same exceptions as in protected mode.

### 64-Bit Mode Exceptions

Same exceptions as in protected mode.

## FPTAN—Partial Tangent

Opcode	Instruction	64-Bit Mode	Compat/ Leg Mode	Description
D9 F2	FPTAN	Valid	Valid	Replace ST(0) with its approximate tangent and push 1 onto the FPU stack.

### Description

Computes the approximate tangent of the source operand in register ST(0), stores the result in ST(0), and pushes a 1.0 onto the FPU register stack. The source operand must be given in radians and must be less than  $\pm 2^{63}$ . The following table shows the unmasked results obtained when computing the partial tangent of various classes of numbers, assuming that underflow does not occur.

**Table 3-33. FPTAN Results**

ST(0) SRC	ST(0) DEST
$-\infty$	*
$-F$	$-F$ to $+F$
$-0$	$-0$
$+0$	$+0$
$+F$	$-F$ to $+F$
$+\infty$	*
NaN	NaN

#### NOTES:

F Means finite floating-point value.

\* Indicates floating-point invalid-arithmic-operand (#IA) exception.

If the source operand is outside the acceptable range, the C2 flag in the FPU status word is set, and the value in register ST(0) remains unchanged. The instruction does not raise an exception when the source operand is out of range. It is up to the program to check the C2 flag for out-of-range conditions. Source values outside the range  $-2^{63}$  to  $+2^{63}$  can be reduced to the range of the instruction by subtracting an appropriate integer multiple of  $2\pi$ . However, even within the range  $-2^{63}$  to  $+2^{63}$ , inaccurate results can occur because the finite approximation of  $\pi$  used internally for argument reduction is not sufficient in all cases. Therefore, for accurate results it is safe to apply FPTAN only to arguments reduced accurately in software, to a value smaller in absolute value than  $3\pi/8$ . See the sections titled "Approximation of Pi" and "Transcendental Instruction Accuracy" in Chapter 8 of the *Intel® 64 and IA-32 Architectures Software Developer's Manual, Volume 1*, for a discussion of the proper value to use for  $\pi$  in performing such reductions.

The value 1.0 is pushed onto the register stack after the tangent has been computed to maintain compatibility with the Intel 8087 and Intel287 math coprocessors. This operation also simplifies the calculation of other trigonometric functions. For instance, the cotangent (which is the reciprocal of the tangent) can be computed by executing a FDIVR instruction after the FPTAN instruction.

This instruction's operation is the same in non-64-bit modes and 64-bit mode.

## Operation

```

IF ST(0) < 263
  THEN
    C2 ← 0;
    ST(0) ← fptan(ST(0)); // approximation of tan
    TOP ← TOP – 1;
    ST(0) ← 1.0;
  ELSE (* Source operand is out-of-range *)
    C2 ← 1;
FI;

```

## FPU Flags Affected

C1 Set to 0 if stack underflow occurred; set to 1 if stack overflow occurred.  
Set if result was rounded up; cleared otherwise.

C2 Set to 1 if outside range ( $-2^{63} < \text{source operand} < +2^{63}$ ); otherwise, set to 0.

C0, C3 Undefined.

## Floating-Point Exceptions

#IS Stack underflow or overflow occurred.

#IA Source operand is an SNaN value,  $\infty$ , or unsupported format.

#D Source operand is a denormal value.

#U Result is too small for destination format.

#P Value cannot be represented exactly in destination format.

## Protected Mode Exceptions

#NM CR0.EM[bit 2] or CR0.TS[bit 3] = 1.

#MF If there is a pending x87 FPU exception.

#UD If the LOCK prefix is used.

## Real-Address Mode Exceptions

Same exceptions as in protected mode.

## Virtual-8086 Mode Exceptions

Same exceptions as in protected mode.

## Compatibility Mode Exceptions

Same exceptions as in protected mode.

## 64-Bit Mode Exceptions

Same exceptions as in protected mode.

## FRNDINT—Round to Integer

Opcode	Instruction	64-Bit Mode	Compat/ Leg Mode	Description
D9 FC	FRNDINT	Valid	Valid	Round ST(0) to an integer.

### Description

Rounds the source value in the ST(0) register to the nearest integral value, depending on the current rounding mode (setting of the RC field of the FPU control word), and stores the result in ST(0).

If the source value is  $\infty$ , the value is not changed. If the source value is not an integral value, the floating-point inexact-result exception (#P) is generated.

This instruction's operation is the same in non-64-bit modes and 64-bit mode.

### Operation

ST(0)  $\leftarrow$  RoundToIntegralValue(ST(0));

### FPU Flags Affected

C1 Set to 0 if stack underflow occurred.  
 Set if result was rounded up; cleared otherwise.  
 C0, C2, C3 Undefined.

### Floating-Point Exceptions

#IS Stack underflow occurred.  
 #IA Source operand is an SNaN value or unsupported format.  
 #D Source operand is a denormal value.  
 #P Source operand is not an integral value.

### Protected Mode Exceptions

#NM CR0.EM[bit 2] or CR0.TS[bit 3] = 1.  
 #MF If there is a pending x87 FPU exception.  
 #UD If the LOCK prefix is used.

### Real-Address Mode Exceptions

Same exceptions as in protected mode.

### Virtual-8086 Mode Exceptions

Same exceptions as in protected mode.

### Compatibility Mode Exceptions

Same exceptions as in protected mode.

### 64-Bit Mode Exceptions

Same exceptions as in protected mode.

## FRSTOR—Restore x87 FPU State

Opcode	Instruction	64-Bit Mode	Compat/ Leg Mode	Description
DD /4	FRSTOR <i>m94/108byte</i>	Valid	Valid	Load FPU state from <i>m94byte</i> or <i>m108byte</i> .

### Description

Loads the FPU state (operating environment and register stack) from the memory area specified with the source operand. This state data is typically written to the specified memory location by a previous FSAVE/FNSAVE instruction.

The FPU operating environment consists of the FPU control word, status word, tag word, instruction pointer, data pointer, and last opcode. Figures 8-9 through 8-12 in the *Intel® 64 and IA-32 Architectures Software Developer's Manual, Volume 1*, show the layout in memory of the stored environment, depending on the operating mode of the processor (protected or real) and the current operand-size attribute (16-bit or 32-bit). In virtual-8086 mode, the real mode layouts are used. The contents of the FPU register stack are stored in the 80 bytes immediately following the operating environment image.

The FRSTOR instruction should be executed in the same operating mode as the corresponding FSAVE/FNSAVE instruction.

If one or more unmasked exception bits are set in the new FPU status word, a floating-point exception will be generated. To avoid raising exceptions when loading a new operating environment, clear all the exception flags in the FPU status word that is being loaded.

This instruction's operation is the same in non-64-bit modes and 64-bit mode.

### Operation

```
FPUControlWord ← SRC[FPUControlWord];
FPUStatusWord ← SRC[FPUStatusWord];
FPUTagWord ← SRC[FPUTagWord];
FPUDataPointer ← SRC[FPUDataPointer];
FPUInstructionPointer ← SRC[FPUInstructionPointer];
FPULastInstructionOpcode ← SRC[FPULastInstructionOpcode];
```

```
ST(0) ← SRC[ST(0)];
ST(1) ← SRC[ST(1)];
ST(2) ← SRC[ST(2)];
ST(3) ← SRC[ST(3)];
ST(4) ← SRC[ST(4)];
ST(5) ← SRC[ST(5)];
ST(6) ← SRC[ST(6)];
ST(7) ← SRC[ST(7)];
```

### FPU Flags Affected

The C0, C1, C2, C3 flags are loaded.

### Floating-Point Exceptions

None; however, this operation might unmask an existing exception that has been detected but not generated, because it was masked. Here, the exception is generated at the completion of the instruction.

**Protected Mode Exceptions**

#GP(0)	If a memory operand effective address is outside the CS, DS, ES, FS, or GS segment limit. If the DS, ES, FS, or GS register is used to access memory and it contains a NULL segment selector.
#SS(0)	If a memory operand effective address is outside the SS segment limit.
#NM	CR0.EM[bit 2] or CR0.TS[bit 3] = 1.
#PF(fault-code)	If a page fault occurs.
#AC(0)	If alignment checking is enabled and an unaligned memory reference is made while the current privilege level is 3.
#UD	If the LOCK prefix is used.

**Real-Address Mode Exceptions**

#GP	If a memory operand effective address is outside the CS, DS, ES, FS, or GS segment limit.
#SS	If a memory operand effective address is outside the SS segment limit.
#NM	CR0.EM[bit 2] or CR0.TS[bit 3] = 1.
#UD	If the LOCK prefix is used.

**Virtual-8086 Mode Exceptions**

#GP(0)	If a memory operand effective address is outside the CS, DS, ES, FS, or GS segment limit.
#SS(0)	If a memory operand effective address is outside the SS segment limit.
#NM	CR0.EM[bit 2] or CR0.TS[bit 3] = 1.
#PF(fault-code)	If a page fault occurs.
#AC(0)	If alignment checking is enabled and an unaligned memory reference is made.
#UD	If the LOCK prefix is used.

**Compatibility Mode Exceptions**

Same exceptions as in protected mode.

**64-Bit Mode Exceptions**

#SS(0)	If a memory address referencing the SS segment is in a non-canonical form.
#GP(0)	If the memory address is in a non-canonical form.
#NM	CR0.EM[bit 2] or CR0.TS[bit 3] = 1.
#PF(fault-code)	If a page fault occurs.
#AC(0)	If alignment checking is enabled and an unaligned memory reference is made while the current privilege level is 3.
#UD	If the LOCK prefix is used.



## FSAVE/FNSAVE—Store x87 FPU State

Opcode	Instruction	64-Bit Mode	Compat/ Leg Mode	Description
9B DD /6	FSAVE <i>m94/108byte</i>	Valid	Valid	Store FPU state to <i>m94byte</i> or <i>m108byte</i> after checking for pending unmasked floating-point exceptions. Then re-initialize the FPU.
DD /6	FNSAVE* <i>m94/108byte</i>	Valid	Valid	Store FPU environment to <i>m94byte</i> or <i>m108byte</i> without checking for pending unmasked floating-point exceptions. Then re-initialize the FPU.

### NOTES:

\* See IA-32 Architecture Compatibility section below.

### Description

Stores the current FPU state (operating environment and register stack) at the specified destination in memory, and then re-initializes the FPU. The FSAVE instruction checks for and handles pending unmasked floating-point exceptions before storing the FPU state; the FNSAVE instruction does not.

The FPU operating environment consists of the FPU control word, status word, tag word, instruction pointer, data pointer, and last opcode. Figures 8-9 through 8-12 in the *Intel® 64 and IA-32 Architectures Software Developer's Manual, Volume 1*, show the layout in memory of the stored environment, depending on the operating mode of the processor (protected or real) and the current operand-size attribute (16-bit or 32-bit). In virtual-8086 mode, the real mode layouts are used. The contents of the FPU register stack are stored in the 80 bytes immediately follow the operating environment image.

The saved image reflects the state of the FPU after all floating-point instructions preceding the FSAVE/FNSAVE instruction in the instruction stream have been executed.

After the FPU state has been saved, the FPU is reset to the same default values it is set to with the FINIT/FNINIT instructions (see "FINIT/FNINIT—Initialize Floating-Point Unit" in this chapter).

The FSAVE/FNSAVE instructions are typically used when the operating system needs to perform a context switch, an exception handler needs to use the FPU, or an application program needs to pass a "clean" FPU to a procedure.

The assembler issues two instructions for the FSAVE instruction (an FWAIT instruction followed by an FNSAVE instruction), and the processor executes each of these instructions separately. If an exception is generated for either of these instructions, the save EIP points to the instruction that caused the exception.

This instruction's operation is the same in non-64-bit modes and 64-bit mode.

### IA-32 Architecture Compatibility

For Intel math coprocessors and FPUs prior to the Intel Pentium processor, an FWAIT instruction should be executed before attempting to read from the memory image stored with a prior FSAVE/FNSAVE instruction. This FWAIT instruction helps ensure that the storage operation has been completed.

When operating a Pentium or Intel486 processor in MS-DOS compatibility mode, it is possible (under unusual circumstances) for an FNSAVE instruction to be interrupted prior to being executed to handle a pending FPU exception. See the section titled "No-Wait FPU Instructions Can Get FPU Interrupt in Window" in Appendix D of the *Intel® 64 and IA-32 Architectures Software Developer's Manual, Volume 1*, for a description of these circumstances. An FNSAVE instruction cannot be interrupted in this way on later Intel processors, except for the Intel Quark™ X1000 processor.

## Operation

(\* Save FPU State and Registers \*)

```

DEST[FPUControlWord] ← FPUControlWord;
DEST[FPUStatusWord] ← FPUStatusWord;
DEST[FPUTagWord] ← FPUTagWord;
DEST[FPUDataPointer] ← FPUDataPointer;
DEST[FPUInstructionPointer] ← FPUInstructionPointer;
DEST[FPULastInstructionOpcode] ← FPULastInstructionOpcode;

```

```

DEST[ST(0)] ← ST(0);
DEST[ST(1)] ← ST(1);
DEST[ST(2)] ← ST(2);
DEST[ST(3)] ← ST(3);
DEST[ST(4)] ← ST(4);
DEST[ST(5)] ← ST(5);
DEST[ST(6)] ← ST(6);
DEST[ST(7)] ← ST(7);

```

(\* Initialize FPU \*)

```

FPUControlWord ← 037FH;
FPUStatusWord ← 0;
FPUTagWord ← FFFFH;
FPUDataPointer ← 0;
FPUInstructionPointer ← 0;
FPULastInstructionOpcode ← 0;

```

## FPU Flags Affected

The C0, C1, C2, and C3 flags are saved and then cleared.

## Floating-Point Exceptions

None.

## Protected Mode Exceptions

#GP(0)	If destination is located in a non-writable segment. If a memory operand effective address is outside the CS, DS, ES, FS, or GS segment limit. If the DS, ES, FS, or GS register is used to access memory and it contains a NULL segment selector.
#SS(0)	If a memory operand effective address is outside the SS segment limit.
#NM	CR0.EM[bit 2] or CR0.TS[bit 3] = 1.
#PF(fault-code)	If a page fault occurs.
#AC(0)	If alignment checking is enabled and an unaligned memory reference is made while the current privilege level is 3.
#UD	If the LOCK prefix is used.

## Real-Address Mode Exceptions

#GP	If a memory operand effective address is outside the CS, DS, ES, FS, or GS segment limit.
#SS	If a memory operand effective address is outside the SS segment limit.
#NM	CR0.EM[bit 2] or CR0.TS[bit 3] = 1.
#UD	If the LOCK prefix is used.

**Virtual-8086 Mode Exceptions**

#GP(0)	If a memory operand effective address is outside the CS, DS, ES, FS, or GS segment limit.
#SS(0)	If a memory operand effective address is outside the SS segment limit.
#NM	CR0.EM[bit 2] or CR0.TS[bit 3] = 1.
#PF(fault-code)	If a page fault occurs.
#AC(0)	If alignment checking is enabled and an unaligned memory reference is made.
#UD	If the LOCK prefix is used.

**Compatibility Mode Exceptions**

Same exceptions as in protected mode.

**64-Bit Mode Exceptions**

#SS(0)	If a memory address referencing the SS segment is in a non-canonical form.
#GP(0)	If the memory address is in a non-canonical form.
#NM	CR0.EM[bit 2] or CR0.TS[bit 3] = 1.
#MF	If there is a pending x87 FPU exception.
#PF(fault-code)	If a page fault occurs.
#AC(0)	If alignment checking is enabled and an unaligned memory reference is made while the current privilege level is 3.

## FSCALE—Scale

Opcode	Instruction	64-Bit Mode	Compat/ Leg Mode	Description
D9 FD	FSCALE	Valid	Valid	Scale ST(0) by ST(1).

### Description

Truncates the value in the source operand (toward 0) to an integral value and adds that value to the exponent of the destination operand. The destination and source operands are floating-point values located in registers ST(0) and ST(1), respectively. This instruction provides rapid multiplication or division by integral powers of 2. The following table shows the results obtained when scaling various classes of numbers, assuming that neither overflow nor underflow occurs.

Table 3-34. FSCALE Results

		ST(1)						NaN
		$-\infty$	- F	- 0	+ 0	+ F	$+\infty$	
ST(0)	$-\infty$	NaN	$-\infty$	$-\infty$	$-\infty$	$-\infty$	$-\infty$	NaN
	- F	- 0	- F	- F	- F	- F	$-\infty$	NaN
	- 0	- 0	- 0	- 0	- 0	- 0	NaN	NaN
	+ 0	+ 0	+ 0	+ 0	+ 0	+ 0	NaN	NaN
	+ F	+ 0	+ F	+ F	+ F	+ F	$+\infty$	NaN
	$+\infty$	NaN	$+\infty$	$+\infty$	$+\infty$	$+\infty$	$+\infty$	NaN
	NaN	NaN	NaN	NaN	NaN	NaN	NaN	NaN

#### NOTES:

F Means finite floating-point value.

In most cases, only the exponent is changed and the mantissa (significand) remains unchanged. However, when the value being scaled in ST(0) is a denormal value, the mantissa is also changed and the result may turn out to be a normalized number. Similarly, if overflow or underflow results from a scale operation, the resulting mantissa will differ from the source’s mantissa.

The FSCALE instruction can also be used to reverse the action of the FXTRACT instruction, as shown in the following example:

```
FXTRACT;
FSCALE;
FSTP ST(1);
```

In this example, the FXTRACT instruction extracts the significand and exponent from the value in ST(0) and stores them in ST(0) and ST(1) respectively. The FSCALE then scales the significand in ST(0) by the exponent in ST(1), recreating the original value before the FXTRACT operation was performed. The FSTP ST(1) instruction overwrites the exponent (extracted by the FXTRACT instruction) with the recreated value, which returns the stack to its original state with only one register [ST(0)] occupied.

This instruction’s operation is the same in non-64-bit modes and 64-bit mode.

### Operation

$$ST(0) \leftarrow ST(0) * 2^{\text{RoundTowardZero}(ST(1))};$$

### FPU Flags Affected

- C1 Set to 0 if stack underflow occurred.
- Set if result was rounded up; cleared otherwise.
- C0, C2, C3 Undefined.

### Floating-Point Exceptions

#IS	Stack underflow occurred.
#IA	Source operand is an SNaN value or unsupported format.
#D	Source operand is a denormal value.
#U	Result is too small for destination format.
#O	Result is too large for destination format.
#P	Value cannot be represented exactly in destination format.

### Protected Mode Exceptions

#NM	CR0.EM[bit 2] or CR0.TS[bit 3] = 1.
#MF	If there is a pending x87 FPU exception.
#UD	If the LOCK prefix is used.

### Real-Address Mode Exceptions

Same exceptions as in protected mode.

### Virtual-8086 Mode Exceptions

Same exceptions as in protected mode.

### Compatibility Mode Exceptions

Same exceptions as in protected mode.

### 64-Bit Mode Exceptions

Same exceptions as in protected mode.

## FSIN—Sine

Opcode	Instruction	64-Bit Mode	Compat/Leg Mode	Description
D9 FE	FSIN	Valid	Valid	Replace ST(0) with the approximate of its sine.

### Description

Computes an approximation of the sine of the source operand in register ST(0) and stores the result in ST(0). The source operand must be given in radians and must be within the range  $-2^{63}$  to  $+2^{63}$ . The following table shows the results obtained when taking the sine of various classes of numbers, assuming that underflow does not occur.

**Table 3-35. FSIN Results**

SRC (ST(0))	DEST (ST(0))
$-\infty$	*
-F	-1 to +1
-0	-0
+0	+0
+F	-1 to +1
$+\infty$	*
NaN	NaN

#### NOTES:

F Means finite floating-point value.

\* Indicates floating-point invalid-arithmetic-operand (#IA) exception.

If the source operand is outside the acceptable range, the C2 flag in the FPU status word is set, and the value in register ST(0) remains unchanged. The instruction does not raise an exception when the source operand is out of range. It is up to the program to check the C2 flag for out-of-range conditions. Source values outside the range  $-2^{63}$  to  $+2^{63}$  can be reduced to the range of the instruction by subtracting an appropriate integer multiple of  $2\pi$ . However, even within the range  $-2^{63}$  to  $+2^{63}$ , inaccurate results can occur because the finite approximation of  $\pi$  used internally for argument reduction is not sufficient in all cases. Therefore, for accurate results it is safe to apply FSIN only to arguments reduced accurately in software, to a value smaller in absolute value than  $3\pi/4$ . See the sections titled "Approximation of Pi" and "Transcendental Instruction Accuracy" in Chapter 8 of the *Intel® 64 and IA-32 Architectures Software Developer's Manual, Volume 1*, for a discussion of the proper value to use for  $\pi$  in performing such reductions.

This instruction's operation is the same in non-64-bit modes and 64-bit mode.

### Operation

```
IF  $-2^{63} < ST(0) < 2^{63}$ 
  THEN
    C2 ← 0;
    ST(0) ← fsin(ST(0)); // approximation of the mathematical sin function
  ELSE (* Source operand out of range *)
    C2 ← 1;
```

FI;

### FPU Flags Affected

C1 Set to 0 if stack underflow occurred.  
 Set if result was rounded up; cleared otherwise.  
 C2 Set to 1 if outside range ( $-2^{63} < \text{source operand} < +2^{63}$ ); otherwise, set to 0.  
 C0, C3 Undefined.

### Floating-Point Exceptions

#IS	Stack underflow occurred.
#IA	Source operand is an SNaN value, $\infty$ , or unsupported format.
#D	Source operand is a denormal value.
#P	Value cannot be represented exactly in destination format.

### Protected Mode Exceptions

#NM	CR0.EM[bit 2] or CR0.TS[bit 3] = 1.
#MF	If there is a pending x87 FPU exception.
#UD	If the LOCK prefix is used.

### Real-Address Mode Exceptions

Same exceptions as in protected mode.

### Virtual-8086 Mode Exceptions

Same exceptions as in protected mode.

### Compatibility Mode Exceptions

Same exceptions as in protected mode.

### 64-Bit Mode Exceptions

Same exceptions as in protected mode.

## FSINCOS—Sine and Cosine

Opcode	Instruction	64-Bit Mode	Compat/ Leg Mode	Description
D9 FB	FSINCOS	Valid	Valid	Compute the sine and cosine of ST(0); replace ST(0) with the approximate sine, and push the approximate cosine onto the register stack.

### Description

Computes both the approximate sine and the cosine of the source operand in register ST(0), stores the sine in ST(0), and pushes the cosine onto the top of the FPU register stack. (This instruction is faster than executing the FSIN and FCOS instructions in succession.)

The source operand must be given in radians and must be within the range  $-2^{63}$  to  $+2^{63}$ . The following table shows the results obtained when taking the sine and cosine of various classes of numbers, assuming that underflow does not occur.

**Table 3-36. FSINCOS Results**

SRC	DEST	
ST(0)	ST(1) Cosine	ST(0) Sine
$-\infty$	*	*
-F	- 1 to + 1	- 1 to + 1
-0	+ 1	- 0
+0	+ 1	+ 0
+F	- 1 to + 1	- 1 to + 1
$+\infty$	*	*
NaN	NaN	NaN

#### NOTES:

F Means finite floating-point value.

\* Indicates floating-point invalid-arithmetic-operand (#IA) exception.

If the source operand is outside the acceptable range, the C2 flag in the FPU status word is set, and the value in register ST(0) remains unchanged. The instruction does not raise an exception when the source operand is out of range. It is up to the program to check the C2 flag for out-of-range conditions. Source values outside the range  $-2^{63}$  to  $+2^{63}$  can be reduced to the range of the instruction by subtracting an appropriate integer multiple of  $2\pi$ . However, even within the range  $-2^{63}$  to  $+2^{63}$ , inaccurate results can occur because the finite approximation of  $\pi$  used internally for argument reduction is not sufficient in all cases. Therefore, for accurate results it is safe to apply FSINCOS only to arguments reduced accurately in software, to a value smaller in absolute value than  $3\pi/8$ . See the sections titled "Approximation of Pi" and "Transcendental Instruction Accuracy" in Chapter 8 of the *Intel® 64 and IA-32 Architectures Software Developer's Manual, Volume 1*, for a discussion of the proper value to use for  $\pi$  in performing such reductions.

This instruction's operation is the same in non-64-bit modes and 64-bit mode.



## Operation

```

IF ST(0) < 263
  THEN
    C2 ← 0;
    TEMP ← fcos(ST(0)); // approximation of cosine
    ST(0) ← fsin(ST(0)); // approximation of sine
    TOP ← TOP - 1;
    ST(0) ← TEMP;
  ELSE (* Source operand out of range *)
    C2 ← 1;
FI;

```

## FPU Flags Affected

C1 Set to 0 if stack underflow occurred; set to 1 of stack overflow occurs.  
Set if result was rounded up; cleared otherwise.

C2 Set to 1 if outside range ( $-2^{63} < \text{source operand} < +2^{63}$ ); otherwise, set to 0.

C0, C3 Undefined.

## Floating-Point Exceptions

#IS Stack underflow or overflow occurred.

#IA Source operand is an SNaN value,  $\infty$ , or unsupported format.

#D Source operand is a denormal value.

#U Result is too small for destination format.

#P Value cannot be represented exactly in destination format.

## Protected Mode Exceptions

#NM CR0.EM[bit 2] or CR0.TS[bit 3] = 1.

#MF If there is a pending x87 FPU exception.

#UD If the LOCK prefix is used.

## Real-Address Mode Exceptions

Same exceptions as in protected mode.

## Virtual-8086 Mode Exceptions

Same exceptions as in protected mode.

## Compatibility Mode Exceptions

Same exceptions as in protected mode.

## 64-Bit Mode Exceptions

Same exceptions as in protected mode.

## FSQRT—Square Root

Opcode	Instruction	64-Bit Mode	Compat/ Leg Mode	Description
D9 FA	FSQRT	Valid	Valid	Computes square root of ST(0) and stores the result in ST(0).

### Description

Computes the square root of the source value in the ST(0) register and stores the result in ST(0).

The following table shows the results obtained when taking the square root of various classes of numbers, assuming that neither overflow nor underflow occurs.

**Table 3-37. FSQRT Results**

SRC (ST(0))	DEST (ST(0))
$-\infty$	*
-F	*
-0	-0
+0	+0
+F	+F
$+\infty$	$+\infty$
NaN	NaN

#### NOTES:

F Means finite floating-point value.

\* Indicates floating-point invalid-arithmetic-operand (#IA) exception.

This instruction's operation is the same in non-64-bit modes and 64-bit mode.

### Operation

ST(0) ← SquareRoot(ST(0));

### FPU Flags Affected

C1	Set to 0 if stack underflow occurred. Set if result was rounded up; cleared otherwise.
C0, C2, C3	Undefined.

### Floating-Point Exceptions

#IS	Stack underflow occurred.
#IA	Source operand is an SNaN value or unsupported format. Source operand is a negative value (except for -0).
#D	Source operand is a denormal value.
#P	Value cannot be represented exactly in destination format.

### Protected Mode Exceptions

#NM	CR0.EM[bit 2] or CR0.TS[bit 3] = 1.
#MF	If there is a pending x87 FPU exception.
#UD	If the LOCK prefix is used.

### Real-Address Mode Exceptions

Same exceptions as in protected mode.

**Virtual-8086 Mode Exceptions**

Same exceptions as in protected mode.

**Compatibility Mode Exceptions**

Same exceptions as in protected mode.

**64-Bit Mode Exceptions**

Same exceptions as in protected mode.

## FST/FSTP—Store Floating Point Value

Opcode	Instruction	64-Bit Mode	Compat/ Leg Mode	Description
D9 /2	FST <i>m32fp</i>	Valid	Valid	Copy ST(0) to <i>m32fp</i> .
DD /2	FST <i>m64fp</i>	Valid	Valid	Copy ST(0) to <i>m64fp</i> .
DD D0+i	FST ST(i)	Valid	Valid	Copy ST(0) to ST(i).
D9 /3	FSTP <i>m32fp</i>	Valid	Valid	Copy ST(0) to <i>m32fp</i> and pop register stack.
DD /3	FSTP <i>m64fp</i>	Valid	Valid	Copy ST(0) to <i>m64fp</i> and pop register stack.
DB /7	FSTP <i>m80fp</i>	Valid	Valid	Copy ST(0) to <i>m80fp</i> and pop register stack.
DD D8+i	FSTP ST(i)	Valid	Valid	Copy ST(0) to ST(i) and pop register stack.

### Description

The FST instruction copies the value in the ST(0) register to the destination operand, which can be a memory location or another register in the FPU register stack. When storing the value in memory, the value is converted to single-precision or double-precision floating-point format.

The FSTP instruction performs the same operation as the FST instruction and then pops the register stack. To pop the register stack, the processor marks the ST(0) register as empty and increments the stack pointer (TOP) by 1. The FSTP instruction can also store values in memory in double extended-precision floating-point format.

If the destination operand is a memory location, the operand specifies the address where the first byte of the destination value is to be stored. If the destination operand is a register, the operand specifies a register in the register stack relative to the top of the stack.

If the destination size is single-precision or double-precision, the significand of the value being stored is rounded to the width of the destination (according to the rounding mode specified by the RC field of the FPU control word), and the exponent is converted to the width and bias of the destination format. If the value being stored is too large for the destination format, a numeric overflow exception (#O) is generated and, if the exception is unmasked, no value is stored in the destination operand. If the value being stored is a denormal value, the denormal exception (#D) is not generated. This condition is simply signaled as a numeric underflow exception (#U) condition.

If the value being stored is  $\pm 0$ ,  $\pm\infty$ , or a NaN, the least-significant bits of the significand and the exponent are truncated to fit the destination format. This operation preserves the value's identity as a 0,  $\infty$ , or NaN.

If the destination operand is a non-empty register, the invalid-operation exception is not generated.

This instruction's operation is the same in non-64-bit modes and 64-bit mode.

### Operation

DEST  $\leftarrow$  ST(0);

```
IF Instruction = FSTP
  THEN
    PopRegisterStack;
FI;
```

### FPU Flags Affected

C1 Set to 0 if stack underflow occurred.  
Indicates rounding direction of if the floating-point inexact exception (#P) is generated: 0  $\leftarrow$  not roundup; 1  $\leftarrow$  roundup.

C0, C2, C3 Undefined.

**Floating-Point Exceptions**

#IS	Stack underflow occurred.
#IA	If destination result is an SNaN value or unsupported format, except when the destination format is in double extended-precision floating-point format.
#U	Result is too small for the destination format.
#O	Result is too large for the destination format.
#P	Value cannot be represented exactly in destination format.

**Protected Mode Exceptions**

#GP(0)	If the destination is located in a non-writable segment. If a memory operand effective address is outside the CS, DS, ES, FS, or GS segment limit. If the DS, ES, FS, or GS register is used to access memory and it contains a NULL segment selector.
#SS(0)	If a memory operand effective address is outside the SS segment limit.
#NM	CR0.EM[bit 2] or CR0.TS[bit 3] = 1.
#PF(fault-code)	If a page fault occurs.
#AC(0)	If alignment checking is enabled and an unaligned memory reference is made while the current privilege level is 3.
#UD	If the LOCK prefix is used.

**Real-Address Mode Exceptions**

#GP	If a memory operand effective address is outside the CS, DS, ES, FS, or GS segment limit.
#SS	If a memory operand effective address is outside the SS segment limit.
#NM	CR0.EM[bit 2] or CR0.TS[bit 3] = 1.
#UD	If the LOCK prefix is used.

**Virtual-8086 Mode Exceptions**

#GP(0)	If a memory operand effective address is outside the CS, DS, ES, FS, or GS segment limit.
#SS(0)	If a memory operand effective address is outside the SS segment limit.
#NM	CR0.EM[bit 2] or CR0.TS[bit 3] = 1.
#PF(fault-code)	If a page fault occurs.
#AC(0)	If alignment checking is enabled and an unaligned memory reference is made.
#UD	If the LOCK prefix is used.

**Compatibility Mode Exceptions**

Same exceptions as in protected mode.

**64-Bit Mode Exceptions**

#SS(0)	If a memory address referencing the SS segment is in a non-canonical form.
#GP(0)	If the memory address is in a non-canonical form.
#NM	CR0.EM[bit 2] or CR0.TS[bit 3] = 1.
#MF	If there is a pending x87 FPU exception.
#PF(fault-code)	If a page fault occurs.
#AC(0)	If alignment checking is enabled and an unaligned memory reference is made while the current privilege level is 3.
#UD	If the LOCK prefix is used.

## FSTCW/FNSTCW—Store x87 FPU Control Word

Opcode	Instruction	64-Bit Mode	Compat/ Leg Mode	Description
9B D9 /7	FSTCW <i>m2byte</i>	Valid	Valid	Store FPU control word to <i>m2byte</i> after checking for pending unmasked floating-point exceptions.
D9 /7	FNSTCW* <i>m2byte</i>	Valid	Valid	Store FPU control word to <i>m2byte</i> without checking for pending unmasked floating-point exceptions.

### NOTES:

\* See IA-32 Architecture Compatibility section below.

### Description

Stores the current value of the FPU control word at the specified destination in memory. The FSTCW instruction checks for and handles pending unmasked floating-point exceptions before storing the control word; the FNSTCW instruction does not.

The assembler issues two instructions for the FSTCW instruction (an FWAIT instruction followed by an FNSTCW instruction), and the processor executes each of these instructions separately. If an exception is generated for either of these instructions, the save EIP points to the instruction that caused the exception.

This instruction's operation is the same in non-64-bit modes and 64-bit mode.

### IA-32 Architecture Compatibility

When operating a Pentium or Intel486 processor in MS-DOS compatibility mode, it is possible (under unusual circumstances) for an FNSTCW instruction to be interrupted prior to being executed to handle a pending FPU exception. See the section titled "No-Wait FPU Instructions Can Get FPU Interrupt in Window" in Appendix D of the *Intel® 64 and IA-32 Architectures Software Developer's Manual, Volume 1*, for a description of these circumstances. An FNSTCW instruction cannot be interrupted in this way on later Intel processors, except for the Intel Quark™ X1000 processor.

### Operation

DEST ← FPUControlWord;

### FPU Flags Affected

The C0, C1, C2, and C3 flags are undefined.

### Floating-Point Exceptions

None.

### Protected Mode Exceptions

#GP(0)	If the destination is located in a non-writable segment. If a memory operand effective address is outside the CS, DS, ES, FS, or GS segment limit. If the DS, ES, FS, or GS register is used to access memory and it contains a NULL segment selector.
#SS(0)	If a memory operand effective address is outside the SS segment limit.
#NM	CR0.EM[bit 2] or CR0.TS[bit 3] = 1.
#PF(fault-code)	If a page fault occurs.
#AC(0)	If alignment checking is enabled and an unaligned memory reference is made while the current privilege level is 3.
#UD	If the LOCK prefix is used.

**Real-Address Mode Exceptions**

#GP	If a memory operand effective address is outside the CS, DS, ES, FS, or GS segment limit.
#SS	If a memory operand effective address is outside the SS segment limit.
#NM	CR0.EM[bit 2] or CR0.TS[bit 3] = 1.
#UD	If the LOCK prefix is used.

**Virtual-8086 Mode Exceptions**

#GP(0)	If a memory operand effective address is outside the CS, DS, ES, FS, or GS segment limit.
#SS(0)	If a memory operand effective address is outside the SS segment limit.
#NM	CR0.EM[bit 2] or CR0.TS[bit 3] = 1.
#PF(fault-code)	If a page fault occurs.
#AC(0)	If alignment checking is enabled and an unaligned memory reference is made.
#UD	If the LOCK prefix is used.

**Compatibility Mode Exceptions**

Same exceptions as in protected mode.

**64-Bit Mode Exceptions**

#SS(0)	If a memory address referencing the SS segment is in a non-canonical form.
#GP(0)	If the memory address is in a non-canonical form.
#NM	CR0.EM[bit 2] or CR0.TS[bit 3] = 1.
#MF	If there is a pending x87 FPU exception.
#PF(fault-code)	If a page fault occurs.
#AC(0)	If alignment checking is enabled and an unaligned memory reference is made while the current privilege level is 3.
#UD	If the LOCK prefix is used.

## FSTENV/FNSTENV—Store x87 FPU Environment

Opcode	Instruction	64-Bit Mode	Compat/ Leg Mode	Description
9B D9 /6	FSTENV <i>m14/28byte</i>	Valid	Valid	Store FPU environment to <i>m14byte</i> or <i>m28byte</i> after checking for pending unmasked floating-point exceptions. Then mask all floating-point exceptions.
D9 /6	FNSTENV <i>m14/28byte</i>	Valid	Valid	Store FPU environment to <i>m14byte</i> or <i>m28byte</i> without checking for pending unmasked floating-point exceptions. Then mask all floating-point exceptions.

### NOTES:

\* See IA-32 Architecture Compatibility section below.

### Description

Saves the current FPU operating environment at the memory location specified with the destination operand, and then masks all floating-point exceptions. The FPU operating environment consists of the FPU control word, status word, tag word, instruction pointer, data pointer, and last opcode. Figures 8-9 through 8-12 in the *Intel® 64 and IA-32 Architectures Software Developer's Manual, Volume 1*, show the layout in memory of the stored environment, depending on the operating mode of the processor (protected or real) and the current operand-size attribute (16-bit or 32-bit). In virtual-8086 mode, the real mode layouts are used.

The FSTENV instruction checks for and handles any pending unmasked floating-point exceptions before storing the FPU environment; the FNSTENV instruction does not. The saved image reflects the state of the FPU after all floating-point instructions preceding the FSTENV/FNSTENV instruction in the instruction stream have been executed.

These instructions are often used by exception handlers because they provide access to the FPU instruction and data pointers. The environment is typically saved in the stack. Masking all exceptions after saving the environment prevents floating-point exceptions from interrupting the exception handler.

The assembler issues two instructions for the FSTENV instruction (an FWAIT instruction followed by an FNSTENV instruction), and the processor executes each of these instructions separately. If an exception is generated for either of these instructions, the save EIP points to the instruction that caused the exception.

This instruction's operation is the same in non-64-bit modes and 64-bit mode.

### IA-32 Architecture Compatibility

When operating a Pentium or Intel486 processor in MS-DOS compatibility mode, it is possible (under unusual circumstances) for an FNSTENV instruction to be interrupted prior to being executed to handle a pending FPU exception. See the section titled "No-Wait FPU Instructions Can Get FPU Interrupt in Window" in Appendix D of the *Intel® 64 and IA-32 Architectures Software Developer's Manual, Volume 1*, for a description of these circumstances. An FNSTENV instruction cannot be interrupted in this way on later Intel processors, except for the Intel Quark™ X1000 processor.

### Operation

```
DEST[FPUControlWord] ← FPUControlWord;
DEST[FPUStatusWord] ← FPUStatusWord;
DEST[FPUTagWord] ← FPUTagWord;
DEST[FPUDataPointer] ← FPUDataPointer;
DEST[FPUInstructionPointer] ← FPUInstructionPointer;
DEST[FPULastInstructionOpcode] ← FPULastInstructionOpcode;
```

### FPU Flags Affected

The C0, C1, C2, and C3 are undefined.



## Floating-Point Exceptions

None

## Protected Mode Exceptions

#GP(0)	If the destination is located in a non-writable segment. If a memory operand effective address is outside the CS, DS, ES, FS, or GS segment limit. If the DS, ES, FS, or GS register is used to access memory and it contains a NULL segment selector.
#SS(0)	If a memory operand effective address is outside the SS segment limit.
#NM	CR0.EM[bit 2] or CR0.TS[bit 3] = 1.
#PF(fault-code)	If a page fault occurs.
#AC(0)	If alignment checking is enabled and an unaligned memory reference is made while the current privilege level is 3.
#UD	If the LOCK prefix is used.

## Real-Address Mode Exceptions

#GP	If a memory operand effective address is outside the CS, DS, ES, FS, or GS segment limit.
#SS	If a memory operand effective address is outside the SS segment limit.
#NM	CR0.EM[bit 2] or CR0.TS[bit 3] = 1.
#UD	If the LOCK prefix is used.

## Virtual-8086 Mode Exceptions

#GP(0)	If a memory operand effective address is outside the CS, DS, ES, FS, or GS segment limit.
#SS(0)	If a memory operand effective address is outside the SS segment limit.
#NM	CR0.EM[bit 2] or CR0.TS[bit 3] = 1.
#PF(fault-code)	If a page fault occurs.
#AC(0)	If alignment checking is enabled and an unaligned memory reference is made.
#UD	If the LOCK prefix is used.

## Compatibility Mode Exceptions

Same exceptions as in protected mode.

## 64-Bit Mode Exceptions

#SS(0)	If a memory address referencing the SS segment is in a non-canonical form.
#GP(0)	If the memory address is in a non-canonical form.
#NM	CR0.EM[bit 2] or CR0.TS[bit 3] = 1.
#MF	If there is a pending x87 FPU exception.
#PF(fault-code)	If a page fault occurs.
#AC(0)	If alignment checking is enabled and an unaligned memory reference is made while the current privilege level is 3.
#UD	If the LOCK prefix is used.

## FSTSW/FNSTSW—Store x87 FPU Status Word

Opcode	Instruction	64-Bit Mode	Compat/ Leg Mode	Description
9B DD /7	FSTSW <i>m2byte</i>	Valid	Valid	Store FPU status word at <i>m2byte</i> after checking for pending unmasked floating-point exceptions.
9B DF E0	FSTSW AX	Valid	Valid	Store FPU status word in AX register after checking for pending unmasked floating-point exceptions.
DD /7	FNSTSW* <i>m2byte</i>	Valid	Valid	Store FPU status word at <i>m2byte</i> without checking for pending unmasked floating-point exceptions.
DF E0	FNSTSW* AX	Valid	Valid	Store FPU status word in AX register without checking for pending unmasked floating-point exceptions.

### NOTES:

\* See IA-32 Architecture Compatibility section below.

### Description

Stores the current value of the x87 FPU status word in the destination location. The destination operand can be either a two-byte memory location or the AX register. The FSTSW instruction checks for and handles pending unmasked floating-point exceptions before storing the status word; the FNSTSW instruction does not.

The FNSTSW AX form of the instruction is used primarily in conditional branching (for instance, after an FPU comparison instruction or an FPREM, FPREM1, or FXAM instruction), where the direction of the branch depends on the state of the FPU condition code flags. (See the section titled “Branching and Conditional Moves on FPU Condition Codes” in Chapter 8 of the *Intel® 64 and IA-32 Architectures Software Developer’s Manual, Volume 1*.) This instruction can also be used to invoke exception handlers (by examining the exception flags) in environments that do not use interrupts. When the FNSTSW AX instruction is executed, the AX register is updated before the processor executes any further instructions. The status stored in the AX register is thus guaranteed to be from the completion of the prior FPU instruction.

The assembler issues two instructions for the FSTSW instruction (an FWAIT instruction followed by an FNSTSW instruction), and the processor executes each of these instructions separately. If an exception is generated for either of these instructions, the save EIP points to the instruction that caused the exception.

This instruction’s operation is the same in non-64-bit modes and 64-bit mode.

### IA-32 Architecture Compatibility

When operating a Pentium or Intel486 processor in MS-DOS compatibility mode, it is possible (under unusual circumstances) for an FNSTSW instruction to be interrupted prior to being executed to handle a pending FPU exception. See the section titled “No-Wait FPU Instructions Can Get FPU Interrupt in Window” in Appendix D of the *Intel® 64 and IA-32 Architectures Software Developer’s Manual, Volume 1*, for a description of these circumstances. An FNSTSW instruction cannot be interrupted in this way on later Intel processors, except for the Intel Quark™ X1000 processor.

### Operation

DEST ← FPUStatusWord;

### FPU Flags Affected

The C0, C1, C2, and C3 are undefined.

### Floating-Point Exceptions

None

**Protected Mode Exceptions**

#GP(0)	If the destination is located in a non-writable segment. If a memory operand effective address is outside the CS, DS, ES, FS, or GS segment limit. If the DS, ES, FS, or GS register is used to access memory and it contains a NULL segment selector.
#SS(0)	If a memory operand effective address is outside the SS segment limit.
#NM	CR0.EM[bit 2] or CR0.TS[bit 3] = 1.
#PF(fault-code)	If a page fault occurs.
#AC(0)	If alignment checking is enabled and an unaligned memory reference is made while the current privilege level is 3.
#UD	If the LOCK prefix is used.

**Real-Address Mode Exceptions**

#GP	If a memory operand effective address is outside the CS, DS, ES, FS, or GS segment limit.
#SS	If a memory operand effective address is outside the SS segment limit.
#NM	CR0.EM[bit 2] or CR0.TS[bit 3] = 1.

**Virtual-8086 Mode Exceptions**

#GP(0)	If a memory operand effective address is outside the CS, DS, ES, FS, or GS segment limit.
#SS(0)	If a memory operand effective address is outside the SS segment limit.
#NM	CR0.EM[bit 2] or CR0.TS[bit 3] = 1.
#PF(fault-code)	If a page fault occurs.
#AC(0)	If alignment checking is enabled and an unaligned memory reference is made.
#UD	If the LOCK prefix is used.

**Compatibility Mode Exceptions**

Same exceptions as in protected mode.

**64-Bit Mode Exceptions**

#SS(0)	If a memory address referencing the SS segment is in a non-canonical form.
#GP(0)	If the memory address is in a non-canonical form.
#NM	CR0.EM[bit 2] or CR0.TS[bit 3] = 1.
#MF	If there is a pending x87 FPU exception.
#PF(fault-code)	If a page fault occurs.
#AC(0)	If alignment checking is enabled and an unaligned memory reference is made while the current privilege level is 3.
#UD	If the LOCK prefix is used.

## FSUB/FSUBP/FISUB—Subtract

Opcode	Instruction	64-Bit Mode	Compat/Leg Mode	Description
D8 /4	FSUB <i>m32fp</i>	Valid	Valid	Subtract <i>m32fp</i> from ST(0) and store result in ST(0).
DC /4	FSUB <i>m64fp</i>	Valid	Valid	Subtract <i>m64fp</i> from ST(0) and store result in ST(0).
D8 E0+i	FSUB ST(0), ST(i)	Valid	Valid	Subtract ST(i) from ST(0) and store result in ST(0).
DC E8+i	FSUB ST(i), ST(0)	Valid	Valid	Subtract ST(0) from ST(i) and store result in ST(i).
DE E8+i	FSUBP ST(i), ST(0)	Valid	Valid	Subtract ST(0) from ST(i), store result in ST(i), and pop register stack.
DE E9	FSUBP	Valid	Valid	Subtract ST(0) from ST(1), store result in ST(1), and pop register stack.
DA /4	FISUB <i>m32int</i>	Valid	Valid	Subtract <i>m32int</i> from ST(0) and store result in ST(0).
DE /4	FISUB <i>m16int</i>	Valid	Valid	Subtract <i>m16int</i> from ST(0) and store result in ST(0).

### Description

Subtracts the source operand from the destination operand and stores the difference in the destination location. The destination operand is always an FPU data register; the source operand can be a register or a memory location. Source operands in memory can be in single-precision or double-precision floating-point format or in word or doubleword integer format.

The no-operand version of the instruction subtracts the contents of the ST(0) register from the ST(1) register and stores the result in ST(1). The one-operand version subtracts the contents of a memory location (either a floating-point or an integer value) from the contents of the ST(0) register and stores the result in ST(0). The two-operand version, subtracts the contents of the ST(0) register from the ST(i) register or vice versa.

The FSUBP instructions perform the additional operation of popping the FPU register stack following the subtraction. To pop the register stack, the processor marks the ST(0) register as empty and increments the stack pointer (TOP) by 1. The no-operand version of the floating-point subtract instructions always results in the register stack being popped. In some assemblers, the mnemonic for this instruction is FSUB rather than FSUBP.

The FISUB instructions convert an integer source operand to double extended-precision floating-point format before performing the subtraction.

Table 3-38 shows the results obtained when subtracting various classes of numbers from one another, assuming that neither overflow nor underflow occurs. Here, the SRC value is subtracted from the DEST value (DEST – SRC = result).

When the difference between two operands of like sign is 0, the result is +0, except for the round toward  $-\infty$  mode, in which case the result is  $-0$ . This instruction also guarantees that  $+0 - (-0) = +0$ , and that  $-0 - (+0) = -0$ . When the source operand is an integer 0, it is treated as a +0.

When one operand is  $\infty$ , the result is  $\infty$  of the expected sign. If both operands are  $\infty$  of the same sign, an invalid-operation exception is generated.

Table 3-38. FSUB/FSUBP/FISUB Results

DEST	SRC						
	$-\infty$	$-F$ or $-I$	$-0$	$+0$	$+F$ or $+I$	$+\infty$	NaN
$-\infty$	*	$-\infty$	$-\infty$	$-\infty$	$-\infty$	$-\infty$	NaN
$-F$	$+\infty$	$\pm F$ or $\pm 0$	DEST	DEST	$-F$	$-\infty$	NaN
$-0$	$+\infty$	$-SRC$	$\pm 0$	$-0$	$-SRC$	$-\infty$	NaN
$+0$	$+\infty$	$-SRC$	$+0$	$\pm 0$	$-SRC$	$-\infty$	NaN
$+F$	$+\infty$	$+F$	DEST	DEST	$\pm F$ or $\pm 0$	$-\infty$	NaN
$+\infty$	$+\infty$	$+\infty$	$+\infty$	$+\infty$	$+\infty$	*	NaN
NaN	NaN	NaN	NaN	NaN	NaN	NaN	NaN

**NOTES:**

F Means finite floating-point value.

I Means integer.

\* Indicates floating-point invalid-arithmic-operand (#IA) exception.

This instruction's operation is the same in non-64-bit modes and 64-bit mode.

**Operation**

IF Instruction = FISUB

THEN

DEST  $\leftarrow$  DEST – ConvertToDoubleExtendedPrecisionFP(SRC);

ELSE (\* Source operand is floating-point value \*)

DEST  $\leftarrow$  DEST – SRC;

FI;

IF Instruction = FSUBP

THEN

PopRegisterStack;

FI;

**FPU Flags Affected**

- C1 Set to 0 if stack underflow occurred.  
Set if result was rounded up; cleared otherwise.
- C0, C2, C3 Undefined.

**Floating-Point Exceptions**

- #IS Stack underflow occurred.
- #IA Operand is an SNaN value or unsupported format.  
Operands are infinities of like sign.
- #D Source operand is a denormal value.
- #U Result is too small for destination format.
- #O Result is too large for destination format.
- #P Value cannot be represented exactly in destination format.

**Protected Mode Exceptions**

#GP(0)	If a memory operand effective address is outside the CS, DS, ES, FS, or GS segment limit. If the DS, ES, FS, or GS register is used to access memory and it contains a NULL segment selector.
#SS(0)	If a memory operand effective address is outside the SS segment limit.
#NM	CR0.EM[bit 2] or CR0.TS[bit 3] = 1.
#PF(fault-code)	If a page fault occurs.
#AC(0)	If alignment checking is enabled and an unaligned memory reference is made while the current privilege level is 3.
#UD	If the LOCK prefix is used.

**Real-Address Mode Exceptions**

#GP	If a memory operand effective address is outside the CS, DS, ES, FS, or GS segment limit.
#SS	If a memory operand effective address is outside the SS segment limit.
#NM	CR0.EM[bit 2] or CR0.TS[bit 3] = 1.
#UD	If the LOCK prefix is used.

**Virtual-8086 Mode Exceptions**

#GP(0)	If a memory operand effective address is outside the CS, DS, ES, FS, or GS segment limit.
#SS(0)	If a memory operand effective address is outside the SS segment limit.
#NM	CR0.EM[bit 2] or CR0.TS[bit 3] = 1.
#PF(fault-code)	If a page fault occurs.
#AC(0)	If alignment checking is enabled and an unaligned memory reference is made.
#UD	If the LOCK prefix is used.

**Compatibility Mode Exceptions**

Same exceptions as in protected mode.

**64-Bit Mode Exceptions**

#SS(0)	If a memory address referencing the SS segment is in a non-canonical form.
#GP(0)	If the memory address is in a non-canonical form.
#NM	CR0.EM[bit 2] or CR0.TS[bit 3] = 1.
#MF	If there is a pending x87 FPU exception.
#PF(fault-code)	If a page fault occurs.
#AC(0)	If alignment checking is enabled and an unaligned memory reference is made while the current privilege level is 3.
#UD	If the LOCK prefix is used.

## FSUBR/FSUBRP/FISUBR—Reverse Subtract

Opcode	Instruction	64-Bit Mode	Compat/ Leg Mode	Description
D8 /5	FSUBR <i>m32fp</i>	Valid	Valid	Subtract ST(0) from <i>m32fp</i> and store result in ST(0).
DC /5	FSUBR <i>m64fp</i>	Valid	Valid	Subtract ST(0) from <i>m64fp</i> and store result in ST(0).
D8 E8+i	FSUBR ST(0), ST(i)	Valid	Valid	Subtract ST(0) from ST(i) and store result in ST(0).
DC E0+i	FSUBR ST(i), ST(0)	Valid	Valid	Subtract ST(i) from ST(0) and store result in ST(i).
DE E0+i	FSUBRP ST(i), ST(0)	Valid	Valid	Subtract ST(i) from ST(0), store result in ST(i), and pop register stack.
DE E1	FSUBRP	Valid	Valid	Subtract ST(1) from ST(0), store result in ST(1), and pop register stack.
DA /5	FISUBR <i>m32int</i>	Valid	Valid	Subtract ST(0) from <i>m32int</i> and store result in ST(0).
DE /5	FISUBR <i>m16int</i>	Valid	Valid	Subtract ST(0) from <i>m16int</i> and store result in ST(0).

### Description

Subtracts the destination operand from the source operand and stores the difference in the destination location. The destination operand is always an FPU register; the source operand can be a register or a memory location. Source operands in memory can be in single-precision or double-precision floating-point format or in word or doubleword integer format.

These instructions perform the reverse operations of the FSUB, FSUBP, and FISUB instructions. They are provided to support more efficient coding.

The no-operand version of the instruction subtracts the contents of the ST(1) register from the ST(0) register and stores the result in ST(1). The one-operand version subtracts the contents of the ST(0) register from the contents of a memory location (either a floating-point or an integer value) and stores the result in ST(0). The two-operand version, subtracts the contents of the ST(i) register from the ST(0) register or vice versa.

The FSUBRP instructions perform the additional operation of popping the FPU register stack following the subtraction. To pop the register stack, the processor marks the ST(0) register as empty and increments the stack pointer (TOP) by 1. The no-operand version of the floating-point reverse subtract instructions always results in the register stack being popped. In some assemblers, the mnemonic for this instruction is FSUBR rather than FSUBRP.

The FISUBR instructions convert an integer source operand to double extended-precision floating-point format before performing the subtraction.

The following table shows the results obtained when subtracting various classes of numbers from one another, assuming that neither overflow nor underflow occurs. Here, the DEST value is subtracted from the SRC value (SRC – DEST = result).

When the difference between two operands of like sign is 0, the result is +0, except for the round toward  $-\infty$  mode, in which case the result is  $-0$ . This instruction also guarantees that  $+0 - (-0) = +0$ , and that  $-0 - (+0) = -0$ . When the source operand is an integer 0, it is treated as a +0.

When one operand is  $\infty$ , the result is  $\infty$  of the expected sign. If both operands are  $\infty$  of the same sign, an invalid-operation exception is generated.

Table 3-39. FSUBR/FSUBRP/FISUBR Results

		SRC						
		$-\infty$	$-F$ or $-I$	$-0$	$+0$	$+F$ or $+I$	$+\infty$	
DEST	$-\infty$	*	$+\infty$	$+\infty$	$+\infty$	$+\infty$	$+\infty$	NaN
	$-F$	$-\infty$	$\pm F$ or $\pm 0$	$-DEST$	$-DEST$	$+F$	$+\infty$	NaN
	$-0$	$-\infty$	SRC	$\pm 0$	$+0$	SRC	$+\infty$	NaN
	$+0$	$-\infty$	SRC	$-0$	$\pm 0$	SRC	$+\infty$	NaN
	$+F$	$-\infty$	$-F$	$-DEST$	$-DEST$	$\pm F$ or $\pm 0$	$+\infty$	NaN
	$+\infty$	$-\infty$	$-\infty$	$-\infty$	$-\infty$	$-\infty$	*	NaN
	NaN	NaN	NaN	NaN	NaN	NaN	NaN	NaN

**NOTES:**

F Means finite floating-point value.

I Means integer.

\* Indicates floating-point invalid-arithmic-operand (#IA) exception.

This instruction's operation is the same in non-64-bit modes and 64-bit mode.

**Operation**

IF Instruction = FISUBR

THEN

DEST  $\leftarrow$  ConvertToDoubleExtendedPrecisionFP(SRC) – DEST;

ELSE (\* Source operand is floating-point value \*)

DEST  $\leftarrow$  SRC – DEST; FI;

IF Instruction = FSUBRP

THEN

PopRegisterStack; FI;

**FPU Flags Affected**

- C1 Set to 0 if stack underflow occurred.  
Set if result was rounded up; cleared otherwise.
- C0, C2, C3 Undefined.

**Floating-Point Exceptions**

- #IS Stack underflow occurred.
- #IA Operand is an SNaN value or unsupported format.  
Operands are infinities of like sign.
- #D Source operand is a denormal value.
- #U Result is too small for destination format.
- #O Result is too large for destination format.
- #P Value cannot be represented exactly in destination format.



**Protected Mode Exceptions**

#GP(0)	If a memory operand effective address is outside the CS, DS, ES, FS, or GS segment limit. If the DS, ES, FS, or GS register is used to access memory and it contains a NULL segment selector.
#SS(0)	If a memory operand effective address is outside the SS segment limit.
#NM	CR0.EM[bit 2] or CR0.TS[bit 3] = 1.
#PF(fault-code)	If a page fault occurs.
#AC(0)	If alignment checking is enabled and an unaligned memory reference is made while the current privilege level is 3.
#UD	If the LOCK prefix is used.

**Real-Address Mode Exceptions**

#GP	If a memory operand effective address is outside the CS, DS, ES, FS, or GS segment limit.
#SS	If a memory operand effective address is outside the SS segment limit.
#NM	CR0.EM[bit 2] or CR0.TS[bit 3] = 1.
#UD	If the LOCK prefix is used.

**Virtual-8086 Mode Exceptions**

#GP(0)	If a memory operand effective address is outside the CS, DS, ES, FS, or GS segment limit.
#SS(0)	If a memory operand effective address is outside the SS segment limit.
#NM	CR0.EM[bit 2] or CR0.TS[bit 3] = 1.
#PF(fault-code)	If a page fault occurs.
#AC(0)	If alignment checking is enabled and an unaligned memory reference is made.
#UD	If the LOCK prefix is used.

**Compatibility Mode Exceptions**

Same exceptions as in protected mode.

**64-Bit Mode Exceptions**

#SS(0)	If a memory address referencing the SS segment is in a non-canonical form.
#GP(0)	If the memory address is in a non-canonical form.
#NM	CR0.EM[bit 2] or CR0.TS[bit 3] = 1.
#MF	If there is a pending x87 FPU exception.
#PF(fault-code)	If a page fault occurs.
#AC(0)	If alignment checking is enabled and an unaligned memory reference is made while the current privilege level is 3.
#UD	If the LOCK prefix is used.

**FTST—TEST**

Opcode	Instruction	64-Bit Mode	Compat/ Leg Mode	Description
D9 E4	FTST	Valid	Valid	Compare ST(0) with 0.0.

**Description**

Compares the value in the ST(0) register with 0.0 and sets the condition code flags C0, C2, and C3 in the FPU status word according to the results (see table below).

**Table 3-40. FTST Results**

Condition	C3	C2	C0
ST(0) > 0.0	0	0	0
ST(0) < 0.0	0	0	1
ST(0) = 0.0	1	0	0
Unordered	1	1	1

This instruction performs an “unordered comparison.” An unordered comparison also checks the class of the numbers being compared (see “FXAM—Examine Floating-Point” in this chapter). If the value in register ST(0) is a NaN or is in an undefined format, the condition flags are set to “unordered” and the invalid operation exception is generated.

The sign of zero is ignored, so that  $(- 0.0 \leftarrow +0.0)$ .

This instruction’s operation is the same in non-64-bit modes and 64-bit mode.

**Operation**

CASE (relation of operands) OF

Not comparable: C3, C2, C0 ← 111;  
 ST(0) > 0.0: C3, C2, C0 ← 000;  
 ST(0) < 0.0: C3, C2, C0 ← 001;  
 ST(0) = 0.0: C3, C2, C0 ← 100;

ESAC;

**FPU Flags Affected**

C1 Set to 0.  
 C0, C2, C3 See Table 3-40.

**Floating-Point Exceptions**

#IS Stack underflow occurred.  
 #IA The source operand is a NaN value or is in an unsupported format.  
 #D The source operand is a denormal value.

**Protected Mode Exceptions**

#NM CR0.EM[bit 2] or CR0.TS[bit 3] = 1.  
 #MF If there is a pending x87 FPU exception.  
 #UD If the LOCK prefix is used.

**Real-Address Mode Exceptions**

Same exceptions as in protected mode.

### **Virtual-8086 Mode Exceptions**

Same exceptions as in protected mode.

### **Compatibility Mode Exceptions**

Same exceptions as in protected mode.

### **64-Bit Mode Exceptions**

Same exceptions as in protected mode.

## FUCOM/FUCOMP/FUCOMPP—Unordered Compare Floating Point Values

Opcode	Instruction	64-Bit Mode	Compat/Leg Mode	Description
DD E0+i	FUCOM ST(i)	Valid	Valid	Compare ST(0) with ST(i).
DD E1	FUCOM	Valid	Valid	Compare ST(0) with ST(1).
DD E8+i	FUCOMP ST(i)	Valid	Valid	Compare ST(0) with ST(i) and pop register stack.
DD E9	FUCOMP	Valid	Valid	Compare ST(0) with ST(1) and pop register stack.
DA E9	FUCOMPP	Valid	Valid	Compare ST(0) with ST(1) and pop register stack twice.

### Description

Performs an unordered comparison of the contents of register ST(0) and ST(i) and sets condition code flags C0, C2, and C3 in the FPU status word according to the results (see the table below). If no operand is specified, the contents of registers ST(0) and ST(1) are compared. The sign of zero is ignored, so that -0.0 is equal to +0.0.

**Table 3-41. FUCOM/FUCOMP/FUCOMPP Results**

Comparison Results*	C3	C2	C0
ST0 > ST(i)	0	0	0
ST0 < ST(i)	0	0	1
ST0 = ST(i)	1	0	0
Unordered	1	1	1

#### NOTES:

\* Flags not set if unmasked invalid-arithmic-operand (#IA) exception is generated.

An unordered comparison checks the class of the numbers being compared (see “FXAM—Examine Floating-Point” in this chapter). The FUCOM/FUCOMP/FUCOMPP instructions perform the same operations as the FCOM/FCOMP/FCOMPP instructions. The only difference is that the FUCOM/FUCOMP/FUCOMPP instructions raise the invalid-arithmic-operand exception (#IA) only when either or both operands are an SNaN or are in an unsupported format; QNaNs cause the condition code flags to be set to unordered, but do not cause an exception to be generated. The FCOM/FCOMP/FCOMPP instructions raise an invalid-operation exception when either or both of the operands are a NaN value of any kind or are in an unsupported format.

As with the FCOM/FCOMP/FCOMPP instructions, if the operation results in an invalid-arithmic-operand exception being raised, the condition code flags are set only if the exception is masked.

The FUCOMP instruction pops the register stack following the comparison operation and the FUCOMPP instruction pops the register stack twice following the comparison operation. To pop the register stack, the processor marks the ST(0) register as empty and increments the stack pointer (TOP) by 1.

This instruction’s operation is the same in non-64-bit modes and 64-bit mode.

## Operation

CASE (relation of operands) OF

ST > SRC: C3, C2, C0 ← 000;

ST < SRC: C3, C2, C0 ← 001;

ST = SRC: C3, C2, C0 ← 100;

ESAC;

IF ST(0) or SRC = QNaN, but not SNaN or unsupported format

THEN

C3, C2, C0 ← 111;

ELSE (\* ST(0) or SRC is SNaN or unsupported format \*)

#IA;

IF FPUControlWord.IM = 1

THEN

C3, C2, C0 ← 111;

FI;

FI;

IF Instruction = FUCOMP

THEN

PopRegisterStack;

FI;

IF Instruction = FUCOMPP

THEN

PopRegisterStack;

FI;

## FPU Flags Affected

C1 Set to 0 if stack underflow occurred.

C0, C2, C3 See Table 3-41.

## Floating-Point Exceptions

#IS Stack underflow occurred.

#IA One or both operands are SNaN values or have unsupported formats. Detection of a QNaN value in and of itself does not raise an invalid-operand exception.

#D One or both operands are denormal values.

## Protected Mode Exceptions

#NM CR0.EM[bit 2] or CR0.TS[bit 3] = 1.

#MF If there is a pending x87 FPU exception.

#UD If the LOCK prefix is used.

## Real-Address Mode Exceptions

Same exceptions as in protected mode.

## Virtual-8086 Mode Exceptions

Same exceptions as in protected mode.

## Compatibility Mode Exceptions

Same exceptions as in protected mode.

### **64-Bit Mode Exceptions**

Same exceptions as in protected mode.

## FXAM—Examine Floating-Point

Opcode	Instruction	64-Bit Mode	Compat/ Leg Mode	Description
D9 E5	FXAM	Valid	Valid	Classify value or number in ST(0).

### Description

Examines the contents of the ST(0) register and sets the condition code flags C0, C2, and C3 in the FPU status word to indicate the class of value or number in the register (see the table below).

**Table 3-42. FXAM Results**

Class	C3	C2	C0
Unsupported	0	0	0
NaN	0	0	1
Normal finite number	0	1	0
Infinity	0	1	1
Zero	1	0	0
Empty	1	0	1
Denormal number	1	1	0

The C1 flag is set to the sign of the value in ST(0), regardless of whether the register is empty or full.

This instruction's operation is the same in non-64-bit modes and 64-bit mode.

### Operation

C1 ← sign bit of ST; (\* 0 for positive, 1 for negative \*)

CASE (class of value or number in ST(0)) OF

  Unsupported: C3, C2, C0 ← 000;

  NaN: C3, C2, C0 ← 001;

  Normal: C3, C2, C0 ← 010;

  Infinity: C3, C2, C0 ← 011;

  Zero: C3, C2, C0 ← 100;

  Empty: C3, C2, C0 ← 101;

  Denormal: C3, C2, C0 ← 110;

ESAC;

### FPU Flags Affected

C1 Sign of value in ST(0).

C0, C2, C3 See Table 3-42.

### Floating-Point Exceptions

None

### Protected Mode Exceptions

#NM CR0.EM[bit 2] or CR0.TS[bit 3] = 1.

#MF If there is a pending x87 FPU exception.

#UD If the LOCK prefix is used.

### Real-Address Mode Exceptions

Same exceptions as in protected mode.

**Virtual-8086 Mode Exceptions**

Same exceptions as in protected mode.

**Compatibility Mode Exceptions**

Same exceptions as in protected mode.

**64-Bit Mode Exceptions**

Same exceptions as in protected mode.



## FXCH—Exchange Register Contents

Opcode	Instruction	64-Bit Mode	Compat/Leg Mode	Description
D9 C8+i	FXCH ST(i)	Valid	Valid	Exchange the contents of ST(0) and ST(i).
D9 C9	FXCH	Valid	Valid	Exchange the contents of ST(0) and ST(1).

### Description

Exchanges the contents of registers ST(0) and ST(i). If no source operand is specified, the contents of ST(0) and ST(1) are exchanged.

This instruction provides a simple means of moving values in the FPU register stack to the top of the stack [ST(0)], so that they can be operated on by those floating-point instructions that can only operate on values in ST(0). For example, the following instruction sequence takes the square root of the third register from the top of the register stack:

```
FXCH ST(3);
FSQRT;
FXCH ST(3);
```

This instruction's operation is the same in non-64-bit modes and 64-bit mode.

### Operation

IF (Number-of-operands) is 1

THEN

```
temp ← ST(0);
ST(0) ← SRC;
SRC ← temp;
```

ELSE

```
temp ← ST(0);
ST(0) ← ST(1);
ST(1) ← temp;
```

FI;

### FPU Flags Affected

C1 Set to 0.  
C0, C2, C3 Undefined.

### Floating-Point Exceptions

#IS Stack underflow occurred.

### Protected Mode Exceptions

#NM CR0.EM[bit 2] or CR0.TS[bit 3] = 1.  
#MF If there is a pending x87 FPU exception.  
#UD If the LOCK prefix is used.

### Real-Address Mode Exceptions

Same exceptions as in protected mode.

### Virtual-8086 Mode Exceptions

Same exceptions as in protected mode.

**Compatibility Mode Exceptions**

Same exceptions as in protected mode.

**64-Bit Mode Exceptions**

Same exceptions as in protected mode.

## FXRSTOR—Restore x87 FPU, MMX, XMM, and MXCSR State

Opcode/ Instruction	Op/ En	64-Bit Mode	Compat/ Leg Mode	Description
NP OF AE /1 FXRSTOR <i>m512byte</i>	M	Valid	Valid	Restore the x87 FPU, MMX, XMM, and MXCSR register state from <i>m512byte</i> .
NP REX.W + OF AE /1 FXRSTOR64 <i>m512byte</i>	M	Valid	N.E.	Restore the x87 FPU, MMX, XMM, and MXCSR register state from <i>m512byte</i> .

### Instruction Operand Encoding

Op/En	Operand 1	Operand 2	Operand 3	Operand 4
M	ModRM:r/m (r)	NA	NA	NA

### Description

Reloads the x87 FPU, MMX technology, XMM, and MXCSR registers from the 512-byte memory image specified in the source operand. This data should have been written to memory previously using the FXSAVE instruction, and in the same format as required by the operating modes. The first byte of the data should be located on a 16-byte boundary. There are three distinct layouts of the FXSAVE state map: one for legacy and compatibility mode, a second format for 64-bit mode FXSAVE/FXRSTOR with REX.W=0, and the third format is for 64-bit mode with FXSAVE64/FXRSTOR64. Table 3-43 shows the layout of the legacy/compatibility mode state information in memory and describes the fields in the memory image for the FXRSTOR and FXSAVE instructions. Table 3-46 shows the layout of the 64-bit mode state information when REX.W is set (FXSAVE64/FXRSTOR64). Table 3-47 shows the layout of the 64-bit mode state information when REX.W is clear (FXSAVE/FXRSTOR).

The state image referenced with an FXRSTOR instruction must have been saved using an FXSAVE instruction or be in the same format as required by Table 3-43, Table 3-46, or Table 3-47. Referencing a state image saved with an FSAVE, FNSAVE instruction or incompatible field layout will result in an incorrect state restoration.

The FXRSTOR instruction does not flush pending x87 FPU exceptions. To check and raise exceptions when loading x87 FPU state information with the FXRSTOR instruction, use an FWAIT instruction after the FXRSTOR instruction.

If the OSFXSR bit in control register CR4 is not set, the FXRSTOR instruction may not restore the states of the XMM and MXCSR registers. This behavior is implementation dependent.

If the MXCSR state contains an unmasked exception with a corresponding status flag also set, loading the register with the FXRSTOR instruction will not result in a SIMD floating-point error condition being generated. Only the next occurrence of this unmasked exception will result in the exception being generated.

Bits 16 through 32 of the MXCSR register are defined as reserved and should be set to 0. Attempting to write a 1 in any of these bits from the saved state image will result in a general protection exception (#GP) being generated.

Bytes 464:511 of an FXSAVE image are available for software use. FXRSTOR ignores the content of bytes 464:511 in an FXSAVE state image.

### Operation

```
IF 64-Bit Mode
  THEN
    (x87 FPU, MMX, XMM15-XMM0, MXCSR) Load(SRC);
  ELSE
    (x87 FPU, MMX, XMM7-XMM0, MXCSR) ← Load(SRC);
FI;
```

### x87 FPU and SIMD Floating-Point Exceptions

None.

**Protected Mode Exceptions**

#GP(0)	For an illegal memory operand effective address in the CS, DS, ES, FS or GS segments. If a memory operand is not aligned on a 16-byte boundary, regardless of segment. (See alignment check exception [#AC] below.) For an attempt to set reserved bits in MXCSR.
#SS(0)	For an illegal address in the SS segment.
#PF(fault-code)	For a page fault.
#NM	If CR0.TS[bit 3] = 1. If CR0.EM[bit 2] = 1.
#UD	If CPUID.01H:EDX.FXSR[bit 24] = 0. If instruction is preceded by a LOCK prefix.
#AC	If this exception is disabled a general protection exception (#GP) is signaled if the memory operand is not aligned on a 16-byte boundary, as described above. If the alignment check exception (#AC) is enabled (and the CPL is 3), signaling of #AC is not guaranteed and may vary with implementation, as follows. In all implementations where #AC is not signaled, a general protection exception is signaled in its place. In addition, the width of the alignment check may also vary with implementation. For instance, for a given implementation, an alignment check exception might be signaled for a 2-byte misalignment, whereas a general protection exception might be signaled for all other misalignments (4-, 8-, or 16-byte misalignments).
#UD	If the LOCK prefix is used.

**Real-Address Mode Exceptions**

#GP	If a memory operand is not aligned on a 16-byte boundary, regardless of segment. If any part of the operand lies outside the effective address space from 0 to FFFFH. For an attempt to set reserved bits in MXCSR.
#NM	If CR0.TS[bit 3] = 1. If CR0.EM[bit 2] = 1.
#UD	If CPUID.01H:EDX.FXSR[bit 24] = 0. If the LOCK prefix is used.

**Virtual-8086 Mode Exceptions**

Same exceptions as in real address mode.

#PF(fault-code)	For a page fault.
#AC	For unaligned memory reference.
#UD	If the LOCK prefix is used.

**Compatibility Mode Exceptions**

Same exceptions as in protected mode.

## 64-Bit Mode Exceptions

#SS(0)	If a memory address referencing the SS segment is in a non-canonical form.
#GP(0)	If the memory address is in a non-canonical form. If memory operand is not aligned on a 16-byte boundary, regardless of segment. For an attempt to set reserved bits in MXCSR.
#PF(fault-code)	For a page fault.
#NM	If CR0.TS[bit 3] = 1. If CR0.EM[bit 2] = 1.
#UD	If CPUID.01H:EDX.FXSR[bit 24] = 0. If instruction is preceded by a LOCK prefix.
#AC	If this exception is disabled a general protection exception (#GP) is signaled if the memory operand is not aligned on a 16-byte boundary, as described above. If the alignment check exception (#AC) is enabled (and the CPL is 3), signaling of #AC is not guaranteed and may vary with implementation, as follows. In all implementations where #AC is not signaled, a general protection exception is signaled in its place. In addition, the width of the alignment check may also vary with implementation. For instance, for a given implementation, an alignment check exception might be signaled for a 2-byte misalignment, whereas a general protection exception might be signaled for all other misalignments (4-, 8-, or 16-byte misalignments).

### FXSAVE—Save x87 FPU, MMX Technology, and SSE State

Opcode/ Instruction	Op/ En	64-Bit Mode	Compat/ Leg Mode	Description
NP OF AE /0 FXSAVE <i>m512byte</i>	M	Valid	Valid	Save the x87 FPU, MMX, XMM, and MXCSR register state to <i>m512byte</i> .
NP REX.W + OF AE /0 FXSAVE64 <i>m512byte</i>	M	Valid	N.E.	Save the x87 FPU, MMX, XMM, and MXCSR register state to <i>m512byte</i> .

#### Instruction Operand Encoding

Op/En	Operand 1	Operand 2	Operand 3	Operand 4
M	ModRM:r/m (w)	NA	NA	NA

#### Description

Saves the current state of the x87 FPU, MMX technology, XMM, and MXCSR registers to a 512-byte memory location specified in the destination operand. The content layout of the 512 byte region depends on whether the processor is operating in non-64-bit operating modes or 64-bit sub-mode of IA-32e mode.

Bytes 464:511 are available to software use. The processor does not write to bytes 464:511 of an FXSAVE area. The operation of FXSAVE in non-64-bit modes is described first.

#### Non-64-Bit Mode Operation

Table 3-43 shows the layout of the state information in memory when the processor is operating in legacy modes.

**Table 3-43. Non-64-bit-Mode Layout of FXSAVE and FXRSTOR Memory Region**

15	14	13	12	11	10	9	8	7	6	5	4	3	2	1	0	
Rsvd		FCS		FIP[31:0]				FOP		Rsvd	FTW		FSW		FCW	<b>0</b>
MXCSR_MASK				MXCSR				Rsvd		FDS			FDP[31:0]			<b>16</b>
Reserved				ST0/MM0								<b>32</b>				
Reserved				ST1/MM1								<b>48</b>				
Reserved				ST2/MM2								<b>64</b>				
Reserved				ST3/MM3								<b>80</b>				
Reserved				ST4/MM4								<b>96</b>				
Reserved				ST5/MM5								<b>112</b>				
Reserved				ST6/MM6								<b>128</b>				
Reserved				ST7/MM7								<b>144</b>				
				XMM0								<b>160</b>				
				XMM1								<b>176</b>				
				XMM2								<b>192</b>				
				XMM3								<b>208</b>				
				XMM4								<b>224</b>				
				XMM5								<b>240</b>				
				XMM6								<b>256</b>				
				XMM7								<b>272</b>				
				Reserved								<b>288</b>				

**Table 3-43. Non-64-bit-Mode Layout of FXSAVE and FXRSTOR Memory Region (Contd.)**

15	14	13	12	11	10	9	8	7	6	5	4	3	2	1	0	
Reserved																304
Reserved																320
Reserved																336
Reserved																352
Reserved																368
Reserved																384
Reserved																400
Reserved																416
Reserved																432
Reserved																448
Available																464
Available																480
Available																496

The destination operand contains the first byte of the memory image, and it must be aligned on a 16-byte boundary. A misaligned destination operand will result in a general-protection (#GP) exception being generated (or in some cases, an alignment check exception [#AC]).

The FXSAVE instruction is used when an operating system needs to perform a context switch or when an exception handler needs to save and examine the current state of the x87 FPU, MMX technology, and/or XMM and MXCSR registers.

The fields in Table 3-43 are defined in Table 3-44.

**Table 3-44. Field Definitions**

Field	Definition
FCW	x87 FPU Control Word (16 bits). See Figure 8-6 in the <i>Intel® 64 and IA-32 Architectures Software Developer's Manual, Volume 1</i> , for the layout of the x87 FPU control word.
FSW	x87 FPU Status Word (16 bits). See Figure 8-4 in the <i>Intel® 64 and IA-32 Architectures Software Developer's Manual, Volume 1</i> , for the layout of the x87 FPU status word.
Abridged FTW	x87 FPU Tag Word (8 bits). The tag information saved here is abridged, as described in the following paragraphs.
FOP	x87 FPU Opcode (16 bits). The lower 11 bits of this field contain the opcode, upper 5 bits are reserved. See Figure 8-8 in the <i>Intel® 64 and IA-32 Architectures Software Developer's Manual, Volume 1</i> , for the layout of the x87 FPU opcode field.
FIP	x87 FPU Instruction Pointer Offset (64 bits). The contents of this field differ depending on the current addressing mode (32-bit, 16-bit, or 64-bit) of the processor when the FXSAVE instruction was executed: 32-bit mode — 32-bit IP offset. 16-bit mode — low 16 bits are IP offset; high 16 bits are reserved. 64-bit mode with REX.W — 64-bit IP offset. 64-bit mode without REX.W — 32-bit IP offset. See "x87 FPU Instruction and Operand (Data) Pointers" in Chapter 8 of the <i>Intel® 64 and IA-32 Architectures Software Developer's Manual, Volume 1</i> , for a description of the x87 FPU instruction pointer.

Table 3-44. Field Definitions (Contd.)

Field	Definition
FCS	x87 FPU Instruction Pointer Selector (16 bits). If CPUID.(EAX=07H,ECX=0H):EBX[bit 13] = 1, the processor deprecates FCS and FDS, and this field is saved as 0000H.
FDP	x87 FPU Instruction Operand (Data) Pointer Offset (64 bits). The contents of this field differ depending on the current addressing mode (32-bit, 16-bit, or 64-bit) of the processor when the FXSAVE instruction was executed: 32-bit mode — 32-bit DP offset. 16-bit mode — low 16 bits are DP offset; high 16 bits are reserved. 64-bit mode with REX.W — 64-bit DP offset. 64-bit mode without REX.W — 32-bit DP offset. See “x87 FPU Instruction and Operand (Data) Pointers” in Chapter 8 of the <i>Intel® 64 and IA-32 Architectures Software Developer’s Manual, Volume 1</i> , for a description of the x87 FPU operand pointer.
FDS	x87 FPU Instruction Operand (Data) Pointer Selector (16 bits). If CPUID.(EAX=07H,ECX=0H):EBX[bit 13] = 1, the processor deprecates FCS and FDS, and this field is saved as 0000H.
MXCSR	MXCSR Register State (32 bits). See Figure 10-3 in the <i>Intel® 64 and IA-32 Architectures Software Developer’s Manual, Volume 1</i> , for the layout of the MXCSR register. If the OSFXSR bit in control register CR4 is not set, the FXSAVE instruction may not save this register. This behavior is implementation dependent.
MXCSR_MASK	MXCSR_MASK (32 bits). This mask can be used to adjust values written to the MXCSR register, ensuring that reserved bits are set to 0. Set the mask bits and flags in MXCSR to the mode of operation desired for SSE and SSE2 SIMD floating-point instructions. See “Guidelines for Writing to the MXCSR Register” in Chapter 11 of the <i>Intel® 64 and IA-32 Architectures Software Developer’s Manual, Volume 1</i> , for instructions for how to determine and use the MXCSR_MASK value.
ST0/MM0 through ST7/MM7	x87 FPU or MMX technology registers. These 80-bit fields contain the x87 FPU data registers or the MMX technology registers, depending on the state of the processor prior to the execution of the FXSAVE instruction. If the processor had been executing x87 FPU instruction prior to the FXSAVE instruction, the x87 FPU data registers are saved; if it had been executing MMX instructions (or SSE or SSE2 instructions that operated on the MMX technology registers), the MMX technology registers are saved. When the MMX technology registers are saved, the high 16 bits of the field are reserved.
XMM0 through XMM7	XMM registers (128 bits per field). If the OSFXSR bit in control register CR4 is not set, the FXSAVE instruction may not save these registers. This behavior is implementation dependent.

The FXSAVE instruction saves an abridged version of the x87 FPU tag word in the FTW field (unlike the FSAVE instruction, which saves the complete tag word). The tag information is saved in physical register order (R0 through R7), rather than in top-of-stack (TOS) order. With the FXSAVE instruction, however, only a single bit (1 for valid or 0 for empty) is saved for each tag. For example, assume that the tag word is currently set as follows:

```
R7 R6 R5 R4 R3 R2 R1 R0
11 xx xx xx 11 11 11 11
```

Here, 11B indicates empty stack elements and “xx” indicates valid (00B), zero (01B), or special (10B).

For this example, the FXSAVE instruction saves only the following 8 bits of information:

```
R7 R6 R5 R4 R3 R2 R1 R0
0 1 1 1 0 0 0 0
```

Here, a 1 is saved for any valid, zero, or special tag, and a 0 is saved for any empty tag.

The operation of the FXSAVE instruction differs from that of the FSAVE instruction, the as follows:

- FXSAVE instruction does not check for pending unmasked floating-point exceptions. (The FXSAVE operation in this regard is similar to the operation of the FNSAVE instruction).
- After the FXSAVE instruction has saved the state of the x87 FPU, MMX technology, XMM, and MXCSR registers, the processor retains the contents of the registers. Because of this behavior, the FXSAVE instruction cannot be



used by an application program to pass a “clean” x87 FPU state to a procedure, since it retains the current state. To clean the x87 FPU state, an application must explicitly execute a FINIT instruction after an FXSAVE instruction to reinitialize the x87 FPU state.

- The format of the memory image saved with the FXSAVE instruction is the same regardless of the current addressing mode (32-bit or 16-bit) and operating mode (protected, real address, or system management). This behavior differs from the FSAVE instructions, where the memory image format is different depending on the addressing mode and operating mode. Because of the different image formats, the memory image saved with the FXSAVE instruction cannot be restored correctly with the FRSTOR instruction, and likewise the state saved with the FSAVE instruction cannot be restored correctly with the FXRSTOR instruction.

The FSAVE format for FTW can be recreated from the FTW valid bits and the stored 80-bit FP data (assuming the stored data was not the contents of MMX technology registers) using Table 3-45.

**Table 3-45. Recreating FSAVE Format**

Exponent all 1's	Exponent all 0's	Fraction all 0's	J and M bits	FTW valid bit	x87 FTW	
0	0	0	0x	1	Special	10
0	0	0	1x	1	Valid	00
0	0	1	00	1	Special	10
0	0	1	10	1	Valid	00
0	1	0	0x	1	Special	10
0	1	0	1x	1	Special	10
0	1	1	00	1	Zero	01
0	1	1	10	1	Special	10
1	0	0	1x	1	Special	10
1	0	0	1x	1	Special	10
1	0	1	00	1	Special	10
1	0	1	10	1	Special	10
For all legal combinations above.				0	Empty	11

The J-bit is defined to be the 1-bit binary integer to the left of the decimal place in the significand. The M-bit is defined to be the most significant bit of the fractional portion of the significand (i.e., the bit immediately to the right of the decimal place).

When the M-bit is the most significant bit of the fractional portion of the significand, it must be 0 if the fraction is all 0's.

### IA-32e Mode Operation

In compatibility sub-mode of IA-32e mode, legacy SSE registers, XMM0 through XMM7, are saved according to the legacy FXSAVE map. In 64-bit mode, all of the SSE registers, XMM0 through XMM15, are saved. Additionally, there are two different layouts of the FXSAVE map in 64-bit mode, corresponding to FXSAVE64 (which requires REX.W=1) and FXSAVE (REX.W=0). In the FXSAVE64 map (Table 3-46), the FPU IP and FPU DP pointers are 64-bit wide. In the FXSAVE map for 64-bit mode (Table 3-47), the FPU IP and FPU DP pointers are 32-bits.

**Table 3-46. Layout of the 64-bit-mode FXSAVE64 Map  
(requires REX.W = 1)**

15	14	13	12	11	10	9	8	7	6	5	4	3	2	1	0	
FIP								FOP		Reserved	FTW	FSW		FCW		<b>0</b>
MXCSR_MASK				MXCSR				FDP								<b>16</b>
Reserved								ST0/MM0								<b>32</b>
Reserved								ST1/MM1								<b>48</b>
Reserved								ST2/MM2								<b>64</b>
Reserved								ST3/MM3								<b>80</b>
Reserved								ST4/MM4								<b>96</b>
Reserved								ST5/MM5								<b>112</b>
Reserved								ST6/MM6								<b>128</b>
Reserved								ST7/MM7								<b>144</b>
								XMM0								<b>160</b>
								XMM1								<b>176</b>
								XMM2								<b>192</b>
								XMM3								<b>208</b>
								XMM4								<b>224</b>
								XMM5								<b>240</b>
								XMM6								<b>256</b>
								XMM7								<b>272</b>
								XMM8								<b>288</b>
								XMM9								<b>304</b>
								XMM10								<b>320</b>
								XMM11								<b>336</b>
								XMM12								<b>352</b>
								XMM13								<b>368</b>
								XMM14								<b>384</b>
								XMM15								<b>400</b>
								Reserved								<b>416</b>
								Reserved								<b>432</b>
								Reserved								<b>448</b>
								Available								<b>464</b>
								Available								<b>480</b>
								Available								<b>496</b>

**Table 3-47. Layout of the 64-bit-mode FXSAVE Map (REX.W = 0)**

15 14	13 12	11 10	9 8	7 6	5	4	3 2	1 0	
Reserved	FCS	FIP[31:0]		FOP	Reserved	FTW	FSW	FCW	<b>0</b>
MXCSR_MASK		MXCSR		Reserved	FDS		FDP[31:0]		<b>16</b>
Reserved			ST0/MM0						<b>32</b>
Reserved			ST1/MM1						<b>48</b>
Reserved			ST2/MM2						<b>64</b>
Reserved			ST3/MM3						<b>80</b>
Reserved			ST4/MM4						<b>96</b>
Reserved			ST5/MM5						<b>112</b>
Reserved			ST6/MM6						<b>128</b>
Reserved			ST7/MM7						<b>144</b>
				XMM0					<b>160</b>
				XMM1					<b>176</b>
				XMM2					<b>192</b>
				XMM3					<b>208</b>
				XMM4					<b>224</b>
				XMM5					<b>240</b>
				XMM6					<b>256</b>
				XMM7					<b>272</b>
				XMM8					<b>288</b>
				XMM9					<b>304</b>
				XMM10					<b>320</b>
				XMM11					<b>336</b>
				XMM12					<b>352</b>
				XMM13					<b>368</b>
				XMM14					<b>384</b>
				XMM15					<b>400</b>
				Reserved					<b>416</b>
				Reserved					<b>432</b>
				Reserved					<b>448</b>
				Available					<b>464</b>
				Available					<b>480</b>
				Available					<b>496</b>

## Operation

```

IF 64-Bit Mode
  THEN
    IF REX.W = 1
      THEN
        DEST ← Save64BitPromotedFxsave(x87 FPU, MMX, XMM15-XMM0,
        MXCSR);
      ELSE
        DEST ← Save64BitDefaultFxsave(x87 FPU, MMX, XMM15-XMM0, MXCSR);
    FI;
  ELSE
    DEST ← SaveLegacyFxsave(x87 FPU, MMX, XMM7-XMM0, MXCSR);
  FI;

```

## Protected Mode Exceptions

#GP(0)	For an illegal memory operand effective address in the CS, DS, ES, FS or GS segments. If a memory operand is not aligned on a 16-byte boundary, regardless of segment. (See the description of the alignment check exception [#AC] below.)
#SS(0)	For an illegal address in the SS segment.
#PF(fault-code)	For a page fault.
#NM	If CR0.TS[bit 3] = 1. If CR0.EM[bit 2] = 1.
#UD	If CPUID.01H:EDX.FXSR[bit 24] = 0.
#UD	If the LOCK prefix is used.
#AC	If this exception is disabled a general protection exception (#GP) is signaled if the memory operand is not aligned on a 16-byte boundary, as described above. If the alignment check exception (#AC) is enabled (and the CPL is 3), signaling of #AC is not guaranteed and may vary with implementation, as follows. In all implementations where #AC is not signaled, a general protection exception is signaled in its place. In addition, the width of the alignment check may also vary with implementation. For instance, for a given implementation, an alignment check exception might be signaled for a 2-byte misalignment, whereas a general protection exception might be signaled for all other misalignments (4-, 8-, or 16-byte misalignments).

## Real-Address Mode Exceptions

#GP	If a memory operand is not aligned on a 16-byte boundary, regardless of segment. If any part of the operand lies outside the effective address space from 0 to FFFFH.
#NM	If CR0.TS[bit 3] = 1. If CR0.EM[bit 2] = 1.
#UD	If CPUID.01H:EDX.FXSR[bit 24] = 0. If the LOCK prefix is used.

## Virtual-8086 Mode Exceptions

Same exceptions as in real address mode.

#PF(fault-code)	For a page fault.
#AC	For unaligned memory reference.
#UD	If the LOCK prefix is used.

## Compatibility Mode Exceptions

Same exceptions as in protected mode.

## 64-Bit Mode Exceptions

#SS(0)	If a memory address referencing the SS segment is in a non-canonical form.
#GP(0)	If the memory address is in a non-canonical form. If memory operand is not aligned on a 16-byte boundary, regardless of segment.
#PF(fault-code)	For a page fault.
#NM	If CR0.TS[bit 3] = 1. If CR0.EM[bit 2] = 1.
#UD	If CPUID.01H:EDX.FXSR[bit 24] = 0. If the LOCK prefix is used.
#AC	If this exception is disabled a general protection exception (#GP) is signaled if the memory operand is not aligned on a 16-byte boundary, as described above. If the alignment check exception (#AC) is enabled (and the CPL is 3), signaling of #AC is not guaranteed and may vary with implementation, as follows. In all implementations where #AC is not signaled, a general protection exception is signaled in its place. In addition, the width of the alignment check may also vary with implementation. For instance, for a given implementation, an alignment check exception might be signaled for a 2-byte misalignment, whereas a general protection exception might be signaled for all other misalignments (4-, 8-, or 16-byte misalignments).

## Implementation Note

The order in which the processor signals general-protection (#GP) and page-fault (#PF) exceptions when they both occur on an instruction boundary is given in Table 5-2 in the *Intel® 64 and IA-32 Architectures Software Developer's Manual, Volume 3B*. This order vary for FXSAVE for different processor implementations.

## FXTRACT—Extract Exponent and Significand

Opcode/ Instruction	64-Bit Mode	Compat/ Leg Mode	Description
D9 F4 FXTRACT	Valid	Valid	Separate value in ST(0) into exponent and significand, store exponent in ST(0), and push the significand onto the register stack.

### Description

Separates the source value in the ST(0) register into its exponent and significand, stores the exponent in ST(0), and pushes the significand onto the register stack. Following this operation, the new top-of-stack register ST(0) contains the value of the original significand expressed as a floating-point value. The sign and significand of this value are the same as those found in the source operand, and the exponent is 3FFFH (biased value for a true exponent of zero). The ST(1) register contains the value of the original operand's true (unbiased) exponent expressed as a floating-point value. (The operation performed by this instruction is a superset of the IEEE-recommended  $\log_b(x)$  function.)

This instruction and the F2XM1 instruction are useful for performing power and range scaling operations. The FXTRACT instruction is also useful for converting numbers in double extended-precision floating-point format to decimal representations (e.g., for printing or displaying).

If the floating-point zero-divide exception (#Z) is masked and the source operand is zero, an exponent value of  $-\infty$  is stored in register ST(1) and 0 with the sign of the source operand is stored in register ST(0).

This instruction's operation is the same in non-64-bit modes and 64-bit mode.

### Operation

```
TEMP ← Significand(ST(0));
ST(0) ← Exponent(ST(0));
TOP ← TOP - 1;
ST(0) ← TEMP;
```

### FPU Flags Affected

C1 Set to 0 if stack underflow occurred; set to 1 if stack overflow occurred.  
C0, C2, C3 Undefined.

### Floating-Point Exceptions

#IS Stack underflow or overflow occurred.  
#IA Source operand is an SNaN value or unsupported format.  
#Z ST(0) operand is  $\pm 0$ .  
#D Source operand is a denormal value.

### Protected Mode Exceptions

#NM CR0.EM[bit 2] or CR0.TS[bit 3] = 1.  
#MF If there is a pending x87 FPU exception.  
#UD If the LOCK prefix is used.

### Real-Address Mode Exceptions

Same exceptions as in protected mode.

### Virtual-8086 Mode Exceptions

Same exceptions as in protected mode.

**Compatibility Mode Exceptions**

Same exceptions as in protected mode.

**64-Bit Mode Exceptions**

Same exceptions as in protected mode.

## FYL2X—Compute $y * \log_2 x$

Opcode	Instruction	64-Bit Mode	Compat/ Leg Mode	Description
D9 F1	FYL2X	Valid	Valid	Replace ST(1) with $(ST(1) * \log_2 ST(0))$ and pop the register stack.

### Description

Computes  $(ST(1) * \log_2 (ST(0)))$ , stores the result in register ST(1), and pops the FPU register stack. The source operand in ST(0) must be a non-zero positive number.

The following table shows the results obtained when taking the log of various classes of numbers, assuming that neither overflow nor underflow occurs.

Table 3-48. FYL2X Results

		ST(0)							
		$-\infty$	$-F$	$\pm 0$	$+0 < +F < +1$	$+1$	$+F > +1$	$+\infty$	NaN
ST(1)	$-\infty$	*	*	$+\infty$	$+\infty$	*	$-\infty$	$-\infty$	NaN
	$-F$	*	*	**	$+F$	$-0$	$-F$	$-\infty$	NaN
	$-0$	*	*	*	$+0$	$-0$	$-0$	*	NaN
	$+0$	*	*	*	$-0$	$+0$	$+0$	*	NaN
	$+F$	*	*	**	$-F$	$+0$	$+F$	$+\infty$	NaN
	$+\infty$	*	*	$-\infty$	$-\infty$	*	$+\infty$	$+\infty$	NaN
	NaN	NaN	NaN	NaN	NaN	NaN	NaN	NaN	NaN

#### NOTES:

F Means finite floating-point value.

\* Indicates floating-point invalid-operation (#IA) exception.

\*\* Indicates floating-point zero-divide (#Z) exception.

If the divide-by-zero exception is masked and register ST(0) contains  $\pm 0$ , the instruction returns  $\infty$  with a sign that is the opposite of the sign of the source operand in register ST(1).

The FYL2X instruction is designed with a built-in multiplication to optimize the calculation of logarithms with an arbitrary positive base (b):

$$\log_b x \leftarrow (\log_2 b)^{-1} * \log_2 x$$

This instruction's operation is the same in non-64-bit modes and 64-bit mode.

### Operation

$ST(1) \leftarrow ST(1) * \log_2 ST(0);$

PopRegisterStack;

### FPU Flags Affected

- C1 Set to 0 if stack underflow occurred.
- Set if result was rounded up; cleared otherwise.
- C0, C2, C3 Undefined.



**Floating-Point Exceptions**

#IS	Stack underflow occurred.
#IA	Either operand is an SNaN or unsupported format. Source operand in register ST(0) is a negative finite value (not -0).
#Z	Source operand in register ST(0) is $\pm 0$ .
#D	Source operand is a denormal value.
#U	Result is too small for destination format.
#O	Result is too large for destination format.
#P	Value cannot be represented exactly in destination format.

**Protected Mode Exceptions**

#NM	CR0.EM[bit 2] or CR0.TS[bit 3] = 1.
#MF	If there is a pending x87 FPU exception.
#UD	If the LOCK prefix is used.

**Real-Address Mode Exceptions**

Same exceptions as in protected mode.

**Virtual-8086 Mode Exceptions**

Same exceptions as in protected mode.

**Compatibility Mode Exceptions**

Same exceptions as in protected mode.

**64-Bit Mode Exceptions**

Same exceptions as in protected mode.

### FYL2XP1—Compute $y * \log_2(x + 1)$

Opcode	Instruction	64-Bit Mode	Compat/ Leg Mode	Description
D9 F9	FYL2XP1	Valid	Valid	Replace ST(1) with $ST(1) * \log_2(ST(0) + 1.0)$ and pop the register stack.

#### Description

Computes  $(ST(1) * \log_2(ST(0) + 1.0))$ , stores the result in register ST(1), and pops the FPU register stack. The source operand in ST(0) must be in the range:

$$-(1 - \sqrt{2}/2) \text{ to } (1 - \sqrt{2}/2)$$

The source operand in ST(1) can range from  $-\infty$  to  $+\infty$ . If the ST(0) operand is outside of its acceptable range, the result is undefined and software should not rely on an exception being generated. Under some circumstances exceptions may be generated when ST(0) is out of range, but this behavior is implementation specific and not guaranteed.

The following table shows the results obtained when taking the log epsilon of various classes of numbers, assuming that underflow does not occur.

**Table 3-49. FYL2XP1 Results**

		ST(0)				
		$-(1 - (\sqrt{2}/2))$ to $-0$	$-0$	$+0$	$+0$ to $+(1 - (\sqrt{2}/2))$	NaN
ST(1)	$-\infty$	$+\infty$	*	*	$-\infty$	NaN
	$-F$	$+F$	$+0$	$-0$	$-F$	NaN
	$-0$	$+0$	$+0$	$-0$	$-0$	NaN
	$+0$	$-0$	$-0$	$+0$	$+0$	NaN
	$+F$	$-F$	$-0$	$+0$	$+F$	NaN
	$+\infty$	$-\infty$	*	*	$+\infty$	NaN
	NaN	NaN	NaN	NaN	NaN	NaN

#### NOTES:

F Means finite floating-point value.

\* Indicates floating-point invalid-operation (#IA) exception.

This instruction provides optimal accuracy for values of epsilon [the value in register ST(0)] that are close to 0. For small epsilon ( $\epsilon$ ) values, more significant digits can be retained by using the FYL2XP1 instruction than by using  $(\epsilon+1)$  as an argument to the FYL2X instruction. The  $(\epsilon+1)$  expression is commonly found in compound interest and annuity calculations. The result can be simply converted into a value in another logarithm base by including a scale factor in the ST(1) source operand. The following equation is used to calculate the scale factor for a particular logarithm base, where n is the logarithm base desired for the result of the FYL2XP1 instruction:

$$\text{scale factor} \leftarrow \log_n 2$$

This instruction’s operation is the same in non-64-bit modes and 64-bit mode.

#### Operation

$$ST(1) \leftarrow ST(1) * \log_2(ST(0) + 1.0);$$

PopRegisterStack;

**FPU Flags Affected**

C1	Set to 0 if stack underflow occurred.
	Set if result was rounded up; cleared otherwise.
C0, C2, C3	Undefined.

**Floating-Point Exceptions**

#IS	Stack underflow occurred.
#IA	Either operand is an SNaN value or unsupported format.
#D	Source operand is a denormal value.
#U	Result is too small for destination format.
#O	Result is too large for destination format.
#P	Value cannot be represented exactly in destination format.

**Protected Mode Exceptions**

#NM	CR0.EM[bit 2] or CR0.TS[bit 3] = 1.
#MF	If there is a pending x87 FPU exception.
#UD	If the LOCK prefix is used.

**Real-Address Mode Exceptions**

Same exceptions as in protected mode.

**Virtual-8086 Mode Exceptions**

Same exceptions as in protected mode.

**Compatibility Mode Exceptions**

Same exceptions as in protected mode.

**64-Bit Mode Exceptions**

Same exceptions as in protected mode.

### HADDPD—Packed Double-FP Horizontal Add

Opcode/ Instruction	Op/ En	64/32-bit Mode	CPUID Feature Flag	Description
66 0F 7C /r HADDPD <i>xmm1, xmm2/m128</i>	RM	V/V	SSE3	Horizontal add packed double-precision floating-point values from <i>xmm2/m128</i> to <i>xmm1</i> .
VEX.NDS.128.66.0F.WIG 7C /r VHADDPD <i>xmm1, xmm2, xmm3/m128</i>	RVM	V/V	AVX	Horizontal add packed double-precision floating-point values from <i>xmm2</i> and <i>xmm3/mem</i> .
VEX.NDS.256.66.0F.WIG 7C /r VHADDPD <i>ymm1, ymm2, ymm3/m256</i>	RVM	V/V	AVX	Horizontal add packed double-precision floating-point values from <i>ymm2</i> and <i>ymm3/mem</i> .

#### Instruction Operand Encoding

Op/En	Operand 1	Operand 2	Operand 3	Operand 4
RM	ModRM:reg ( <i>r, w</i> )	ModRM:r/m ( <i>r</i> )	NA	NA
RVM	ModRM:reg ( <i>w</i> )	VEX.vvvv ( <i>r</i> )	ModRM:r/m ( <i>r</i> )	NA

#### Description

Adds the double-precision floating-point values in the high and low quadwords of the destination operand and stores the result in the low quadword of the destination operand.

Adds the double-precision floating-point values in the high and low quadwords of the source operand and stores the result in the high quadword of the destination operand.

In 64-bit mode, use of the REX.R prefix permits this instruction to access additional registers (XMM8-XMM15).

See Figure 3-16 for HADDPD; see Figure 3-17 for VHADDPD.

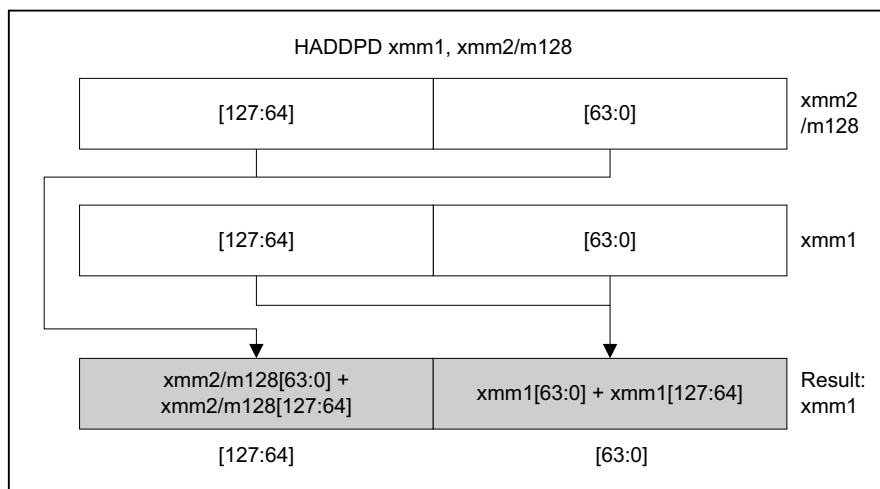

OM15993

Figure 3-16. HADDPD—Packed Double-FP Horizontal Add

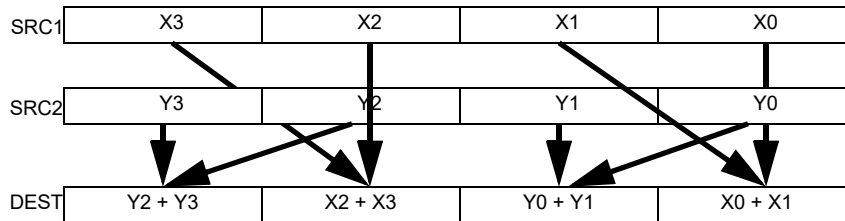

**Figure 3-17. VHADDPD operation**

128-bit Legacy SSE version: The second source can be an XMM register or a 128-bit memory location. The destination is not distinct from the first source XMM register and the upper bits (MAXVL-1:128) of the corresponding YMM register destination are unmodified.

VEX.128 encoded version: the first source operand is an XMM register or 128-bit memory location. The destination operand is an XMM register. The upper bits (MAXVL-1:128) of the corresponding YMM register destination are zeroed.

VEX.256 encoded version: The first source operand is a YMM register. The second source operand can be a YMM register or a 256-bit memory location. The destination operand is a YMM register.

### Operation

#### HADDPD (128-bit Legacy SSE version)

$$\text{DEST}[63:0] \leftarrow \text{SRC1}[127:64] + \text{SRC1}[63:0]$$

$$\text{DEST}[127:64] \leftarrow \text{SRC2}[127:64] + \text{SRC2}[63:0]$$

$$\text{DEST}[\text{MAXVL}-1:128] \text{ (Unmodified)}$$

#### VHADDPD (VEX.128 encoded version)

$$\text{DEST}[63:0] \leftarrow \text{SRC1}[127:64] + \text{SRC1}[63:0]$$

$$\text{DEST}[127:64] \leftarrow \text{SRC2}[127:64] + \text{SRC2}[63:0]$$

$$\text{DEST}[\text{MAXVL}-1:128] \leftarrow 0$$

#### VHADDPD (VEX.256 encoded version)

$$\text{DEST}[63:0] \leftarrow \text{SRC1}[127:64] + \text{SRC1}[63:0]$$

$$\text{DEST}[127:64] \leftarrow \text{SRC2}[127:64] + \text{SRC2}[63:0]$$

$$\text{DEST}[191:128] \leftarrow \text{SRC1}[255:192] + \text{SRC1}[191:128]$$

$$\text{DEST}[255:192] \leftarrow \text{SRC2}[255:192] + \text{SRC2}[191:128]$$

### Intel C/C++ Compiler Intrinsic Equivalent

VHADDPD: `__m256d _mm256_hadd_pd (__m256d a, __m256d b);`

HADDPD: `__m128d _mm_hadd_pd (__m128d a, __m128d b);`

### Exceptions

When the source operand is a memory operand, the operand must be aligned on a 16-byte boundary or a general-protection exception (#GP) will be generated.

**Numeric Exceptions**

Overflow, Underflow, Invalid, Precision, Denormal

**Other Exceptions**

See Exceptions Type 2.

## HADDPS—Packed Single-FP Horizontal Add

Opcode/ Instruction	Op/ En	64/32-bit Mode	CPUID Feature Flag	Description
F2 0F 7C /r HADDPS <i>xmm1</i> , <i>xmm2/m128</i>	RM	V/V	SSE3	Horizontal add packed single-precision floating-point values from <i>xmm2/m128</i> to <i>xmm1</i> .
VEX.NDS.128.F2.0F.WIG 7C /r VHADDPS <i>xmm1</i> , <i>xmm2</i> , <i>xmm3/m128</i>	RVM	V/V	AVX	Horizontal add packed single-precision floating-point values from <i>xmm2</i> and <i>xmm3/mem</i> .
VEX.NDS.256.F2.0F.WIG 7C /r VHADDPS <i>ymm1</i> , <i>ymm2</i> , <i>ymm3/m256</i>	RVM	V/V	AVX	Horizontal add packed single-precision floating-point values from <i>ymm2</i> and <i>ymm3/mem</i> .

### Instruction Operand Encoding

Op/En	Operand 1	Operand 2	Operand 3	Operand 4
RM	ModRM:reg (r, w)	ModRM:r/m (r)	NA	NA
RVM	ModRM:reg (w)	VEX.vvvv (r)	ModRM:r/m (r)	NA

### Description

Adds the single-precision floating-point values in the first and second dwords of the destination operand and stores the result in the first dword of the destination operand.

Adds single-precision floating-point values in the third and fourth dword of the destination operand and stores the result in the second dword of the destination operand.

Adds single-precision floating-point values in the first and second dword of the source operand and stores the result in the third dword of the destination operand.

Adds single-precision floating-point values in the third and fourth dword of the source operand and stores the result in the fourth dword of the destination operand.

In 64-bit mode, use of the REX.R prefix permits this instruction to access additional registers (XMM8-XMM15).

See Figure 3-18 for HADDPS; see Figure 3-19 for VHADDPS.

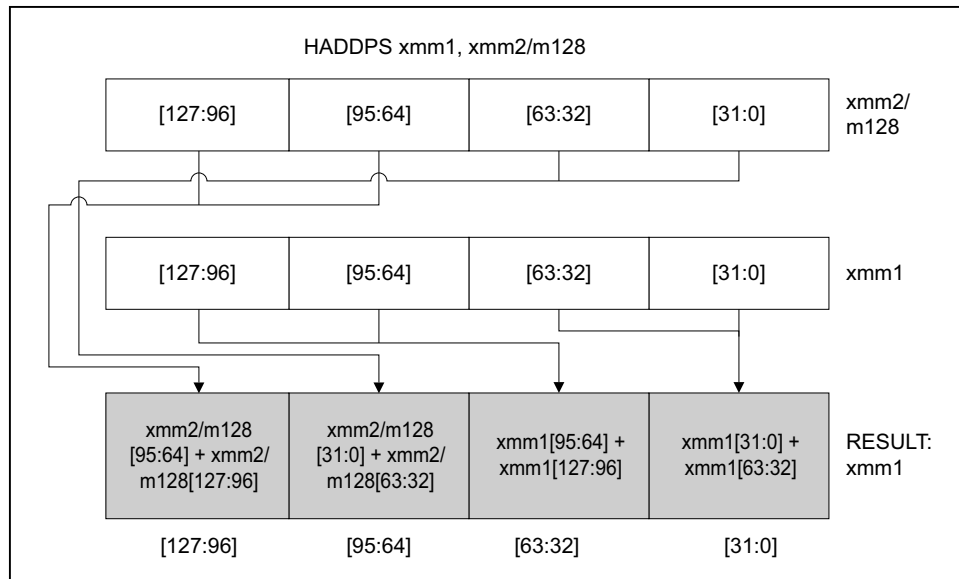

OM15994

**Figure 3-18. HADDPS—Packed Single-FP Horizontal Add**

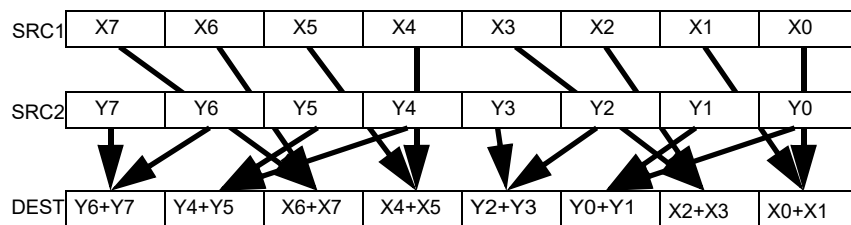

**Figure 3-19. VHADDPS operation**

128-bit Legacy SSE version: The second source can be an XMM register or a 128-bit memory location. The destination is not distinct from the first source XMM register and the upper bits (MAXVL-1:128) of the corresponding YMM register destination are unmodified.

VEX.128 encoded version: the first source operand is an XMM register or 128-bit memory location. The destination operand is an XMM register. The upper bits (MAXVL-1:128) of the corresponding YMM register destination are zeroed.

VEX.256 encoded version: The first source operand is a YMM register. The second source operand can be a YMM register or a 256-bit memory location. The destination operand is a YMM register.



## Operation

### HADDPS (128-bit Legacy SSE version)

$DEST[31:0] \leftarrow SRC1[63:32] + SRC1[31:0]$   
 $DEST[63:32] \leftarrow SRC1[127:96] + SRC1[95:64]$   
 $DEST[95:64] \leftarrow SRC2[63:32] + SRC2[31:0]$   
 $DEST[127:96] \leftarrow SRC2[127:96] + SRC2[95:64]$   
 $DEST[MAXVL-1:128]$  (Unmodified)

### VHADDPS (VEX.128 encoded version)

$DEST[31:0] \leftarrow SRC1[63:32] + SRC1[31:0]$   
 $DEST[63:32] \leftarrow SRC1[127:96] + SRC1[95:64]$   
 $DEST[95:64] \leftarrow SRC2[63:32] + SRC2[31:0]$   
 $DEST[127:96] \leftarrow SRC2[127:96] + SRC2[95:64]$   
 $DEST[MAXVL-1:128] \leftarrow 0$

### VHADDPS (VEX.256 encoded version)

$DEST[31:0] \leftarrow SRC1[63:32] + SRC1[31:0]$   
 $DEST[63:32] \leftarrow SRC1[127:96] + SRC1[95:64]$   
 $DEST[95:64] \leftarrow SRC2[63:32] + SRC2[31:0]$   
 $DEST[127:96] \leftarrow SRC2[127:96] + SRC2[95:64]$   
 $DEST[159:128] \leftarrow SRC1[191:160] + SRC1[159:128]$   
 $DEST[191:160] \leftarrow SRC1[255:224] + SRC1[223:192]$   
 $DEST[223:192] \leftarrow SRC2[191:160] + SRC2[159:128]$   
 $DEST[255:224] \leftarrow SRC2[255:224] + SRC2[223:192]$

## Intel C/C++ Compiler Intrinsic Equivalent

HADDPS: `__m128 _mm_hadd_ps (__m128 a, __m128 b);`

VHADDPS: `__m256 _mm256_hadd_ps (__m256 a, __m256 b);`

## Exceptions

When the source operand is a memory operand, the operand must be aligned on a 16-byte boundary or a general-protection exception (#GP) will be generated.

## Numeric Exceptions

Overflow, Underflow, Invalid, Precision, Denormal

## Other Exceptions

See Exceptions Type 2.

**HLT—Halt**

Opcode	Instruction	Op/En	64-Bit Mode	Compat/Leg Mode	Description
F4	HLT	Z0	Valid	Valid	Halt

**Instruction Operand Encoding**

Op/En	Operand 1	Operand 2	Operand 3	Operand 4
Z0	NA	NA	NA	NA

**Description**

Stops instruction execution and places the processor in a HALT state. An enabled interrupt (including NMI and SMI), a debug exception, the BINIT# signal, the INIT# signal, or the RESET# signal will resume execution. If an interrupt (including NMI) is used to resume execution after a HLT instruction, the saved instruction pointer (CS:EIP) points to the instruction following the HLT instruction.

When a HLT instruction is executed on an Intel 64 or IA-32 processor supporting Intel Hyper-Threading Technology, only the logical processor that executes the instruction is halted. The other logical processors in the physical processor remain active, unless they are each individually halted by executing a HLT instruction.

The HLT instruction is a privileged instruction. When the processor is running in protected or virtual-8086 mode, the privilege level of a program or procedure must be 0 to execute the HLT instruction.

This instruction's operation is the same in non-64-bit modes and 64-bit mode.

**Operation**

Enter Halt state;

**Flags Affected**

None

**Protected Mode Exceptions**

#GP(0) If the current privilege level is not 0.

#UD If the LOCK prefix is used.

**Real-Address Mode Exceptions**

None.

**Virtual-8086 Mode Exceptions**

Same exceptions as in protected mode.

**Compatibility Mode Exceptions**

Same exceptions as in protected mode.

**64-Bit Mode Exceptions**

Same exceptions as in protected mode.

## HSUBPD—Packed Double-FP Horizontal Subtract

Opcode/ Instruction	Op/ En	64/32-bit Mode	CPUID Feature Flag	Description
66 0F 7D /r HSUBPD <i>xmm1, xmm2/m128</i>	RM	V/V	SSE3	Horizontal subtract packed double-precision floating-point values from <i>xmm2/m128</i> to <i>xmm1</i> .
VEX.NDS.128.66.0F.WIG 7D /r VHSUBPD <i>xmm1, xmm2, xmm3/m128</i>	RVM	V/V	AVX	Horizontal subtract packed double-precision floating-point values from <i>xmm2</i> and <i>xmm3/mem</i> .
VEX.NDS.256.66.0F.WIG 7D /r VHSUBPD <i>ymm1, ymm2, ymm3/m256</i>	RVM	V/V	AVX	Horizontal subtract packed double-precision floating-point values from <i>ymm2</i> and <i>ymm3/mem</i> .

### Instruction Operand Encoding

Op/En	Operand 1	Operand 2	Operand 3	Operand 4
RM	ModRM:reg (r, w)	ModRM:r/m (r)	NA	NA
RVM	ModRM:reg (w)	VEX.vvvv (r)	ModRM:r/m (r)	NA

### Description

The HSUBPD instruction subtracts horizontally the packed DP FP numbers of both operands.

Subtracts the double-precision floating-point value in the high quadword of the destination operand from the low quadword of the destination operand and stores the result in the low quadword of the destination operand.

Subtracts the double-precision floating-point value in the high quadword of the source operand from the low quadword of the source operand and stores the result in the high quadword of the destination operand.

In 64-bit mode, use of the REX.R prefix permits this instruction to access additional registers (XMM8-XMM15).

See Figure 3-20 for HSUBPD; see Figure 3-21 for VHSUBPD.

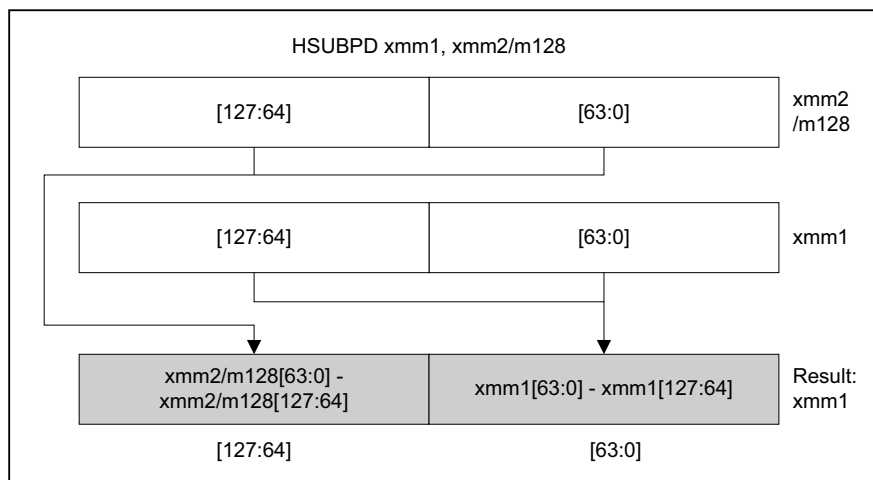

OM15995

Figure 3-20. HSUBPD—Packed Double-FP Horizontal Subtract

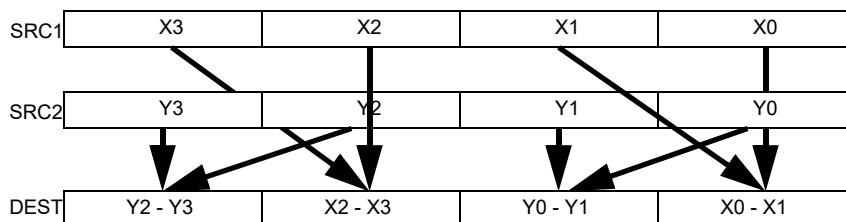

**Figure 3-21. VHSUBPD operation**

128-bit Legacy SSE version: The second source can be an XMM register or a 128-bit memory location. The destination is not distinct from the first source XMM register and the upper bits (MAXVL-1:128) of the corresponding YMM register destination are unmodified.

VEX.128 encoded version: the first source operand is an XMM register or 128-bit memory location. The destination operand is an XMM register. The upper bits (MAXVL-1:128) of the corresponding YMM register destination are zeroed.

VEX.256 encoded version: The first source operand is a YMM register. The second source operand can be a YMM register or a 256-bit memory location. The destination operand is a YMM register.

## Operation

### HSUBPD (128-bit Legacy SSE version)

```
DEST[63:0] ← SRC1[63:0] - SRC1[127:64]
DEST[127:64] ← SRC2[63:0] - SRC2[127:64]
DEST[MAXVL-1:128] (Unmodified)
```

### VHSUBPD (VEX.128 encoded version)

```
DEST[63:0] ← SRC1[63:0] - SRC1[127:64]
DEST[127:64] ← SRC2[63:0] - SRC2[127:64]
DEST[MAXVL-1:128] ← 0
```

### VHSUBPD (VEX.256 encoded version)

```
DEST[63:0] ← SRC1[63:0] - SRC1[127:64]
DEST[127:64] ← SRC2[63:0] - SRC2[127:64]
DEST[191:128] ← SRC1[191:128] - SRC1[255:192]
DEST[255:192] ← SRC2[191:128] - SRC2[255:192]
```

## Intel C/C++ Compiler Intrinsic Equivalent

HSUBPD: `__m128d _mm_hsub_pd(__m128d a, __m128d b)`

VHSUBPD: `__m256d _mm256_hsub_pd(__m256d a, __m256d b);`

## Exceptions

When the source operand is a memory operand, the operand must be aligned on a 16-byte boundary or a general-protection exception (#GP) will be generated.

## Numeric Exceptions

Overflow, Underflow, Invalid, Precision, Denormal

**Other Exceptions**

See Exceptions Type 2.

**HSUBPS—Packed Single-FP Horizontal Subtract**

Opcode/ Instruction	Op/ En	64/32-bit Mode	CPUID Feature Flag	Description
F2 0F 7D /r HSUBPS <i>xmm1, xmm2/m128</i>	RM	V/V	SSE3	Horizontal subtract packed single-precision floating-point values from <i>xmm2/m128</i> to <i>xmm1</i> .
VEX.NDS.128.F2.0F.WIG 7D /r VHSUBPS <i>xmm1, xmm2, xmm3/m128</i>	RVM	V/V	AVX	Horizontal subtract packed single-precision floating-point values from <i>xmm2</i> and <i>xmm3/mem</i> .
VEX.NDS.256.F2.0F.WIG 7D /r VHSUBPS <i>ymm1, ymm2, ymm3/m256</i>	RVM	V/V	AVX	Horizontal subtract packed single-precision floating-point values from <i>ymm2</i> and <i>ymm3/mem</i> .

**Instruction Operand Encoding**

Op/En	Operand 1	Operand 2	Operand 3	Operand 4
RM	ModRM:reg (r, w)	ModRM:r/m (r)	NA	NA
RVM	ModRM:reg (w)	VEX.vvvv (r)	ModRM:r/m (r)	NA

**Description**

Subtracts the single-precision floating-point value in the second dword of the destination operand from the first dword of the destination operand and stores the result in the first dword of the destination operand.

Subtracts the single-precision floating-point value in the fourth dword of the destination operand from the third dword of the destination operand and stores the result in the second dword of the destination operand.

Subtracts the single-precision floating-point value in the second dword of the source operand from the first dword of the source operand and stores the result in the third dword of the destination operand.

Subtracts the single-precision floating-point value in the fourth dword of the source operand from the third dword of the source operand and stores the result in the fourth dword of the destination operand.

In 64-bit mode, use of the REX.R prefix permits this instruction to access additional registers (XMM8-XMM15).

See Figure 3-22 for HSUBPS; see Figure 3-23 for VHSUBPS.

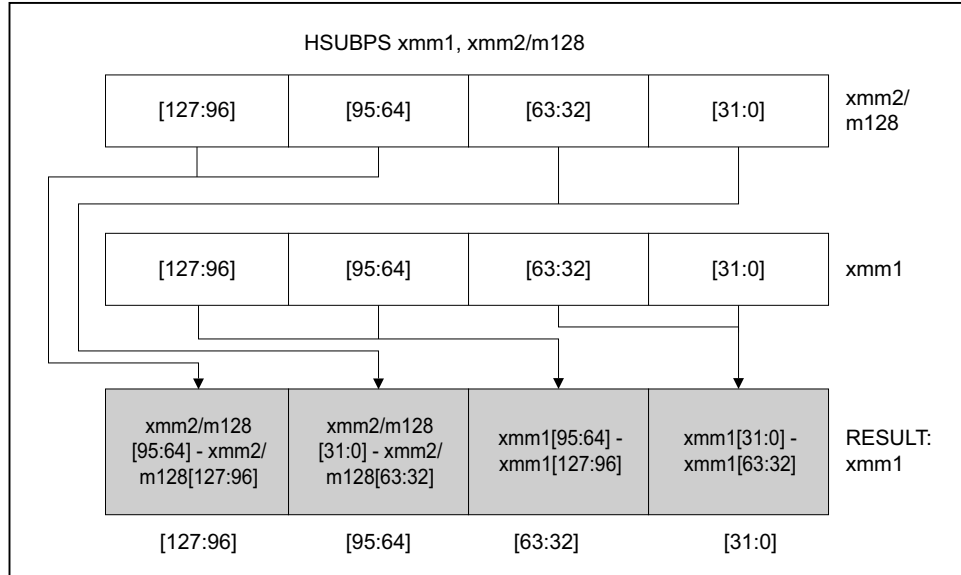

OM15996

**Figure 3-22. HSUBPS—Packed Single-FP Horizontal Subtract**

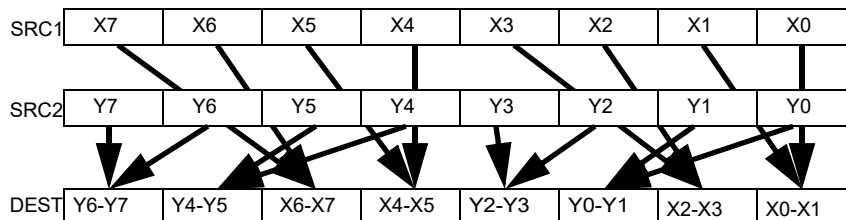

**Figure 3-23. VHSUBPS operation**

128-bit Legacy SSE version: The second source can be an XMM register or a 128-bit memory location. The destination is not distinct from the first source XMM register and the upper bits (MAXVL-1:128) of the corresponding YMM register destination are unmodified.

VEX.128 encoded version: the first source operand is an XMM register or 128-bit memory location. The destination operand is an XMM register. The upper bits (MAXVL-1:128) of the corresponding YMM register destination are zeroed.

VEX.256 encoded version: The first source operand is a YMM register. The second source operand can be a YMM register or a 256-bit memory location. The destination operand is a YMM register.

## Operation

### HSUBPS (128-bit Legacy SSE version)

$\text{DEST}[31:0] \leftarrow \text{SRC1}[31:0] - \text{SRC1}[63:32]$   
 $\text{DEST}[63:32] \leftarrow \text{SRC1}[95:64] - \text{SRC1}[127:96]$   
 $\text{DEST}[95:64] \leftarrow \text{SRC2}[31:0] - \text{SRC2}[63:32]$   
 $\text{DEST}[127:96] \leftarrow \text{SRC2}[95:64] - \text{SRC2}[127:96]$   
 $\text{DEST}[\text{MAXVL}-1:128]$  (Unmodified)

### VHSUBPS (VEX.128 encoded version)

$\text{DEST}[31:0] \leftarrow \text{SRC1}[31:0] - \text{SRC1}[63:32]$   
 $\text{DEST}[63:32] \leftarrow \text{SRC1}[95:64] - \text{SRC1}[127:96]$   
 $\text{DEST}[95:64] \leftarrow \text{SRC2}[31:0] - \text{SRC2}[63:32]$   
 $\text{DEST}[127:96] \leftarrow \text{SRC2}[95:64] - \text{SRC2}[127:96]$   
 $\text{DEST}[\text{MAXVL}-1:128] \leftarrow 0$

### VHSUBPS (VEX.256 encoded version)

$\text{DEST}[31:0] \leftarrow \text{SRC1}[31:0] - \text{SRC1}[63:32]$   
 $\text{DEST}[63:32] \leftarrow \text{SRC1}[95:64] - \text{SRC1}[127:96]$   
 $\text{DEST}[95:64] \leftarrow \text{SRC2}[31:0] - \text{SRC2}[63:32]$   
 $\text{DEST}[127:96] \leftarrow \text{SRC2}[95:64] - \text{SRC2}[127:96]$   
 $\text{DEST}[159:128] \leftarrow \text{SRC1}[159:128] - \text{SRC1}[191:160]$   
 $\text{DEST}[191:160] \leftarrow \text{SRC1}[223:192] - \text{SRC1}[255:224]$   
 $\text{DEST}[223:192] \leftarrow \text{SRC2}[159:128] - \text{SRC2}[191:160]$   
 $\text{DEST}[255:224] \leftarrow \text{SRC2}[223:192] - \text{SRC2}[255:224]$

## Intel C/C++ Compiler Intrinsic Equivalent

HSUBPS: `__m128 _mm_hsub_ps(__m128 a, __m128 b);`

VHSUBPS: `__m256 _mm256_hsub_ps(__m256 a, __m256 b);`

## Exceptions

When the source operand is a memory operand, the operand must be aligned on a 16-byte boundary or a general-protection exception (#GP) will be generated.

## Numeric Exceptions

Overflow, Underflow, Invalid, Precision, Denormal

## Other Exceptions

See Exceptions Type 2.



## IDIV—Signed Divide

Opcode	Instruction	Op/En	64-Bit Mode	Compat/Leg Mode	Description
F6 /7	IDIV <i>r/m8</i>	M	Valid	Valid	Signed divide AX by <i>r/m8</i> , with result stored in: AL ← Quotient, AH ← Remainder.
REX + F6 /7	IDIV <i>r/m8</i> *	M	Valid	N.E.	Signed divide AX by <i>r/m8</i> , with result stored in AL ← Quotient, AH ← Remainder.
F7 /7	IDIV <i>r/m16</i>	M	Valid	Valid	Signed divide DX:AX by <i>r/m16</i> , with result stored in AX ← Quotient, DX ← Remainder.
F7 /7	IDIV <i>r/m32</i>	M	Valid	Valid	Signed divide EDX:EAX by <i>r/m32</i> , with result stored in EAX ← Quotient, EDX ← Remainder.
REX.W + F7 /7	IDIV <i>r/m64</i>	M	Valid	N.E.	Signed divide RDX:RAX by <i>r/m64</i> , with result stored in RAX ← Quotient, RDX ← Remainder.

### NOTES:

\* In 64-bit mode, *r/m8* can not be encoded to access the following byte registers if a REX prefix is used: AH, BH, CH, DH.

### Instruction Operand Encoding

Op/En	Operand 1	Operand 2	Operand 3	Operand 4
M	ModRM:r/m ( <i>r</i> )	NA	NA	NA

### Description

Divides the (signed) value in the AX, DX:AX, or EDX:EAX (dividend) by the source operand (divisor) and stores the result in the AX (AH:AL), DX:AX, or EDX:EAX registers. The source operand can be a general-purpose register or a memory location. The action of this instruction depends on the operand size (dividend/divisor).

Non-integral results are truncated (chopped) towards 0. The remainder is always less than the divisor in magnitude. Overflow is indicated with the #DE (divide error) exception rather than with the CF flag.

In 64-bit mode, the instruction's default operation size is 32 bits. Use of the REX.R prefix permits access to additional registers (R8-R15). Use of the REX.W prefix promotes operation to 64 bits. In 64-bit mode when REX.W is applied, the instruction divides the signed value in RDX:RAX by the source operand. RAX contains a 64-bit quotient; RDX contains a 64-bit remainder.

See the summary chart at the beginning of this section for encoding data and limits. See Table 3-50.

**Table 3-50. IDIV Results**

Operand Size	Dividend	Divisor	Quotient	Remainder	Quotient Range
Word/byte	AX	<i>r/m8</i>	AL	AH	−128 to +127
Doubleword/word	DX:AX	<i>r/m16</i>	AX	DX	−32,768 to +32,767
Quadword/doubleword	EDX:EAX	<i>r/m32</i>	EAX	EDX	−2 <sup>31</sup> to 2 <sup>31</sup> − 1
Doublequadword/quadword	RDX:RAX	<i>r/m64</i>	RAX	RDX	−2 <sup>63</sup> to 2 <sup>63</sup> − 1

**Operation**

```

IF SRC = 0
  THEN #DE; (* Divide error *)
FI;

IF OperandSize = 8 (* Word/byte operation *)
  THEN
    temp ← AX / SRC; (* Signed division *)
    IF (temp > 7FH) or (temp < 80H)
      (* If a positive result is greater than 7FH or a negative result is less than 80H *)
      THEN #DE; (* Divide error *)
    ELSE
      AL ← temp;
      AH ← AX SignedModulus SRC;
    FI;
  ELSE IF OperandSize = 16 (* Doubleword/word operation *)
    THEN
      temp ← DX:AX / SRC; (* Signed division *)
      IF (temp > 7FFFH) or (temp < 8000H)
        (* If a positive result is greater than 7FFFH
        or a negative result is less than 8000H *)
        THEN
          #DE; (* Divide error *)
        ELSE
          AX ← temp;
          DX ← DX:AX SignedModulus SRC;
        FI;
      FI;
    ELSE IF OperandSize = 32 (* Quadword/doubleword operation *)
      THEN
        temp ← EDX:EAX / SRC; (* Signed division *)
        IF (temp > 7FFFFFFFFFH) or (temp < 80000000H)
          (* If a positive result is greater than 7FFFFFFFFFH
          or a negative result is less than 80000000H *)
          THEN
            #DE; (* Divide error *)
          ELSE
            EAX ← temp;
            EDX ← EDX:EAX SignedModulus SRC;
          FI;
        FI;
      ELSE IF OperandSize = 64 (* Doublequadword/quadword operation *)
        THEN
          temp ← RDX:RAX / SRC; (* Signed division *)
          IF (temp > 7FFFFFFFFFFFFFFFFFH) or (temp < 8000000000000000H)
            (* If a positive result is greater than 7FFFFFFFFFFFFFFFFFH
            or a negative result is less than 8000000000000000H *)
            THEN
              #DE; (* Divide error *)
            ELSE
              RAX ← temp;
              RDX ← RDX:RAX SignedModulus SRC;
            FI;
          FI;
        FI;
      FI;
    FI;
  FI;

```

## Flags Affected

The CF, OF, SF, ZF, AF, and PF flags are undefined.

## Protected Mode Exceptions

#DE	If the source operand (divisor) is 0. The signed result (quotient) is too large for the destination.
#GP(0)	If a memory operand effective address is outside the CS, DS, ES, FS, or GS segment limit. If the DS, ES, FS, or GS register is used to access memory and it contains a NULL segment selector.
#SS(0)	If a memory operand effective address is outside the SS segment limit.
#PF(fault-code)	If a page fault occurs.
#AC(0)	If alignment checking is enabled and an unaligned memory reference is made while the current privilege level is 3.
#UD	If the LOCK prefix is used.

## Real-Address Mode Exceptions

#DE	If the source operand (divisor) is 0.  The signed result (quotient) is too large for the destination.
#GP	If a memory operand effective address is outside the CS, DS, ES, FS, or GS segment limit.
#SS	If a memory operand effective address is outside the SS segment limit.
#UD	If the LOCK prefix is used.

## Virtual-8086 Mode Exceptions

#DE	If the source operand (divisor) is 0.  The signed result (quotient) is too large for the destination.
#GP(0)	If a memory operand effective address is outside the CS, DS, ES, FS, or GS segment limit.
#SS(0)	If a memory operand effective address is outside the SS segment limit.
#PF(fault-code)	If a page fault occurs.
#AC(0)	If alignment checking is enabled and an unaligned memory reference is made.
#UD	If the LOCK prefix is used.

## Compatibility Mode Exceptions

Same exceptions as in protected mode.

## 64-Bit Mode Exceptions

#SS(0)	If a memory address referencing the SS segment is in a non-canonical form.
#GP(0)	If the memory address is in a non-canonical form.
#DE	If the source operand (divisor) is 0 If the quotient is too large for the designated register.
#PF(fault-code)	If a page fault occurs.
#AC(0)	If alignment checking is enabled and an unaligned memory reference is made while the current privilege level is 3.
#UD	If the LOCK prefix is used.

## IMUL—Signed Multiply

Opcode	Instruction	Op/En	64-Bit Mode	Compat/Leg Mode	Description
F6 /5	IMUL <i>r/m8</i> *	M	Valid	Valid	AX ← AL * <i>r/m</i> byte.
F7 /5	IMUL <i>r/m16</i>	M	Valid	Valid	DX:AX ← AX * <i>r/m</i> word.
F7 /5	IMUL <i>r/m32</i>	M	Valid	Valid	EDX:EAX ← EAX * <i>r/m32</i> .
REX.W + F7 /5	IMUL <i>r/m64</i>	M	Valid	N.E.	RDX:RAX ← RAX * <i>r/m64</i> .
OF AF /r	IMUL <i>r16, r/m16</i>	RM	Valid	Valid	word register ← word register * <i>r/m16</i> .
OF AF /r	IMUL <i>r32, r/m32</i>	RM	Valid	Valid	doubleword register ← doubleword register * <i>r/m32</i> .
REX.W + OF AF /r	IMUL <i>r64, r/m64</i>	RM	Valid	N.E.	Quadword register ← Quadword register * <i>r/m64</i> .
6B /r ib	IMUL <i>r16, r/m16, imm8</i>	RMI	Valid	Valid	word register ← <i>r/m16</i> * sign-extended immediate byte.
6B /r ib	IMUL <i>r32, r/m32, imm8</i>	RMI	Valid	Valid	doubleword register ← <i>r/m32</i> * sign-extended immediate byte.
REX.W + 6B /r ib	IMUL <i>r64, r/m64, imm8</i>	RMI	Valid	N.E.	Quadword register ← <i>r/m64</i> * sign-extended immediate byte.
69 /r iw	IMUL <i>r16, r/m16, imm16</i>	RMI	Valid	Valid	word register ← <i>r/m16</i> * immediate word.
69 /r id	IMUL <i>r32, r/m32, imm32</i>	RMI	Valid	Valid	doubleword register ← <i>r/m32</i> * immediate doubleword.
REX.W + 69 /r id	IMUL <i>r64, r/m64, imm32</i>	RMI	Valid	N.E.	Quadword register ← <i>r/m64</i> * immediate doubleword.

### NOTES:

\* In 64-bit mode, *r/m8* can not be encoded to access the following byte registers if a REX prefix is used: AH, BH, CH, DH.

### Instruction Operand Encoding

Op/En	Operand 1	Operand 2	Operand 3	Operand 4
M	ModRM:r/m ( <i>r, w</i> )	NA	NA	NA
RM	ModRM:reg ( <i>r, w</i> )	ModRM:r/m ( <i>r</i> )	NA	NA
RMI	ModRM:reg ( <i>r, w</i> )	ModRM:r/m ( <i>r</i> )	imm8/16/32	NA

### Description

Performs a signed multiplication of two operands. This instruction has three forms, depending on the number of operands.

- **One-operand form** — This form is identical to that used by the MUL instruction. Here, the source operand (in a general-purpose register or memory location) is multiplied by the value in the AL, AX, EAX, or RAX register (depending on the operand size) and the product (twice the size of the input operand) is stored in the AX, DX:AX, EDX:EAX, or RDX:RAX registers, respectively.
- **Two-operand form** — With this form the destination operand (the first operand) is multiplied by the source operand (second operand). The destination operand is a general-purpose register and the source operand is an immediate value, a general-purpose register, or a memory location. The intermediate product (twice the size of the input operand) is truncated and stored in the destination operand location.
- **Three-operand form** — This form requires a destination operand (the first operand) and two source operands (the second and the third operands). Here, the first source operand (which can be a general-purpose register or a memory location) is multiplied by the second source operand (an immediate value). The intermediate product (twice the size of the first source operand) is truncated and stored in the destination operand (a general-purpose register).

When an immediate value is used as an operand, it is sign-extended to the length of the destination operand format.

The CF and OF flags are set when the signed integer value of the intermediate product differs from the sign extended operand-size-truncated product, otherwise the CF and OF flags are cleared.

The three forms of the IMUL instruction are similar in that the length of the product is calculated to twice the length of the operands. With the one-operand form, the product is stored exactly in the destination. With the two- and three- operand forms, however, the result is truncated to the length of the destination before it is stored in the destination register. Because of this truncation, the CF or OF flag should be tested to ensure that no significant bits are lost.

The two- and three-operand forms may also be used with unsigned operands because the lower half of the product is the same regardless if the operands are signed or unsigned. The CF and OF flags, however, cannot be used to determine if the upper half of the result is non-zero.

In 64-bit mode, the instruction's default operation size is 32 bits. Use of the REX.R prefix permits access to additional registers (R8-R15). Use of the REX.W prefix promotes operation to 64 bits. Use of REX.W modifies the three forms of the instruction as follows.

- **One-operand form** —The source operand (in a 64-bit general-purpose register or memory location) is multiplied by the value in the RAX register and the product is stored in the RDX:RAX registers.
- **Two-operand form** — The source operand is promoted to 64 bits if it is a register or a memory location. The destination operand is promoted to 64 bits.
- **Three-operand form** — The first source operand (either a register or a memory location) and destination operand are promoted to 64 bits. If the source operand is an immediate, it is sign extended to 64 bits.

## Operation

```

IF (NumberOfOperands = 1)
  THEN IF (OperandSize = 8)
    THEN
      TMP_XP ← AL * SRC (* Signed multiplication; TMP_XP is a signed integer at twice the width of the SRC *);
      AX ← TMP_XP[15:0];
      IF SignExtend(TMP_XP[7:0]) = TMP_XP
        THEN CF ← 0; OF ← 0;
        ELSE CF ← 1; OF ← 1; FI;
    ELSE IF OperandSize = 16
      THEN
        TMP_XP ← AX * SRC (* Signed multiplication; TMP_XP is a signed integer at twice the width of the SRC *)
        DX:AX ← TMP_XP[31:0];
        IF SignExtend(TMP_XP[15:0]) = TMP_XP
          THEN CF ← 0; OF ← 0;
          ELSE CF ← 1; OF ← 1; FI;
    ELSE IF OperandSize = 32
      THEN
        TMP_XP ← EAX * SRC (* Signed multiplication; TMP_XP is a signed integer at twice the width of the SRC *)
        EDX:EAX ← TMP_XP[63:0];
        IF SignExtend(TMP_XP[31:0]) = TMP_XP
          THEN CF ← 0; OF ← 0;
          ELSE CF ← 1; OF ← 1; FI;
    ELSE (* OperandSize = 64 *)
      TMP_XP ← RAX * SRC (* Signed multiplication; TMP_XP is a signed integer at twice the width of the SRC *)
      EDX:EAX ← TMP_XP[127:0];
      IF SignExtend(TMP_XP[63:0]) = TMP_XP
        THEN CF ← 0; OF ← 0;
        ELSE CF ← 1; OF ← 1; FI;
  FI;

```

```

FI;
ELSE IF (NumberOfOperands = 2)
  THEN
    TMP_XP ← DEST * SRC (* Signed multiplication; TMP_XP is a signed integer at twice the width of the SRC *)
    DEST ← TruncateToOperandSize(TMP_XP);
    IF SignExtend(DEST) ≠ TMP_XP
      THEN CF ← 1; OF ← 1;
      ELSE CF ← 0; OF ← 0; FI;
  ELSE (* NumberOfOperands = 3 *)
    TMP_XP ← SRC1 * SRC2 (* Signed multiplication; TMP_XP is a signed integer at twice the width of the SRC1 *)
    DEST ← TruncateToOperandSize(TMP_XP);
    IF SignExtend(DEST) ≠ TMP_XP
      THEN CF ← 1; OF ← 1;
      ELSE CF ← 0; OF ← 0; FI;
FI;
FI;

```

### Flags Affected

For the one operand form of the instruction, the CF and OF flags are set when significant bits are carried into the upper half of the result and cleared when the result fits exactly in the lower half of the result. For the two- and three-operand forms of the instruction, the CF and OF flags are set when the result must be truncated to fit in the destination operand size and cleared when the result fits exactly in the destination operand size. The SF, ZF, AF, and PF flags are undefined.

### Protected Mode Exceptions

#GP(0)	If a memory operand effective address is outside the CS, DS, ES, FS, or GS segment limit. If the DS, ES, FS, or GS register is used to access memory and it contains a NULL NULL segment selector.
#SS(0)	If a memory operand effective address is outside the SS segment limit.
#PF(fault-code)	If a page fault occurs.
#AC(0)	If alignment checking is enabled and an unaligned memory reference is made while the current privilege level is 3.
#UD	If the LOCK prefix is used.

### Real-Address Mode Exceptions

#GP	If a memory operand effective address is outside the CS, DS, ES, FS, or GS segment limit.
#SS	If a memory operand effective address is outside the SS segment limit.
#UD	If the LOCK prefix is used.

### Virtual-8086 Mode Exceptions

#GP(0)	If a memory operand effective address is outside the CS, DS, ES, FS, or GS segment limit.
#SS(0)	If a memory operand effective address is outside the SS segment limit.
#PF(fault-code)	If a page fault occurs.
#AC(0)	If alignment checking is enabled and an unaligned memory reference is made.
#UD	If the LOCK prefix is used.

### Compatibility Mode Exceptions

Same exceptions as in protected mode.

## 64-Bit Mode Exceptions

#SS(0)	If a memory address referencing the SS segment is in a non-canonical form.
#GP(0)	If the memory address is in a non-canonical form.
#PF(fault-code)	If a page fault occurs.
#AC(0)	If alignment checking is enabled and an unaligned memory reference is made while the current privilege level is 3.
#UD	If the LOCK prefix is used.

## IN—Input from Port

Opcode	Instruction	Op/En	64-Bit Mode	Compat/Leg Mode	Description
E4 <i>ib</i>	IN AL, <i>imm8</i>	I	Valid	Valid	Input byte from <i>imm8</i> I/O port address into AL.
E5 <i>ib</i>	IN AX, <i>imm8</i>	I	Valid	Valid	Input word from <i>imm8</i> I/O port address into AX.
E5 <i>ib</i>	IN EAX, <i>imm8</i>	I	Valid	Valid	Input dword from <i>imm8</i> I/O port address into EAX.
EC	IN AL,DX	ZO	Valid	Valid	Input byte from I/O port in DX into AL.
ED	IN AX,DX	ZO	Valid	Valid	Input word from I/O port in DX into AX.
ED	IN EAX,DX	ZO	Valid	Valid	Input doubleword from I/O port in DX into EAX.

### Instruction Operand Encoding

Op/En	Operand 1	Operand 2	Operand 3	Operand 4
I	<i>imm8</i>	NA	NA	NA
ZO	NA	NA	NA	NA

### Description

Copies the value from the I/O port specified with the second operand (source operand) to the destination operand (first operand). The source operand can be a byte-immediate or the DX register; the destination operand can be register AL, AX, or EAX, depending on the size of the port being accessed (8, 16, or 32 bits, respectively). Using the DX register as a source operand allows I/O port addresses from 0 to 65,535 to be accessed; using a byte immediate allows I/O port addresses 0 to 255 to be accessed.

When accessing an 8-bit I/O port, the opcode determines the port size; when accessing a 16- and 32-bit I/O port, the operand-size attribute determines the port size. At the machine code level, I/O instructions are shorter when accessing 8-bit I/O ports. Here, the upper eight bits of the port address will be 0.

This instruction is only useful for accessing I/O ports located in the processor's I/O address space. See Chapter 18, "Input/Output," in the *Intel® 64 and IA-32 Architectures Software Developer's Manual, Volume 1*, for more information on accessing I/O ports in the I/O address space.

This instruction's operation is the same in non-64-bit modes and 64-bit mode.

### Operation

```
IF ((PE = 1) and ((CPL > IOPL) or (VM = 1)))
  THEN (* Protected mode with CPL > IOPL or virtual-8086 mode *)
    IF (Any I/O Permission Bit for I/O port being accessed = 1)
      THEN (* I/O operation is not allowed *)
        #GP(0);
      ELSE (* I/O operation is allowed *)
        DEST ← SRC; (* Read from selected I/O port *)
    FI;
  ELSE (Real Mode or Protected Mode with CPL ≤ IOPL *)
    DEST ← SRC; (* Read from selected I/O port *)
  FI;
```

### Flags Affected

None



### Protected Mode Exceptions

- #GP(0) If the CPL is greater than (has less privilege) the I/O privilege level (IOPL) and any of the corresponding I/O permission bits in TSS for the I/O port being accessed is 1.
- #UD If the LOCK prefix is used.

### Real-Address Mode Exceptions

- #UD If the LOCK prefix is used.

### Virtual-8086 Mode Exceptions

- #GP(0) If any of the I/O permission bits in the TSS for the I/O port being accessed is 1.
- #PF(fault-code) If a page fault occurs.
- #UD If the LOCK prefix is used.

### Compatibility Mode Exceptions

Same exceptions as in protected mode.

### 64-Bit Mode Exceptions

- #GP(0) If the CPL is greater than (has less privilege) the I/O privilege level (IOPL) and any of the corresponding I/O permission bits in TSS for the I/O port being accessed is 1.
- #UD If the LOCK prefix is used.

## INC—Increment by 1

Opcode	Instruction	Op/En	64-Bit Mode	Compat/Leg Mode	Description
FE /0	INC <i>r/m8</i>	M	Valid	Valid	Increment <i>r/m</i> byte by 1.
REX + FE /0	INC <i>r/m8</i> *	M	Valid	N.E.	Increment <i>r/m</i> byte by 1.
FF /0	INC <i>r/m16</i>	M	Valid	Valid	Increment <i>r/m</i> word by 1.
FF /0	INC <i>r/m32</i>	M	Valid	Valid	Increment <i>r/m</i> doubleword by 1.
REX.W + FF /0	INC <i>r/m64</i>	M	Valid	N.E.	Increment <i>r/m</i> quadword by 1.
40+ <i>rw</i> **	INC <i>r16</i>	O	N.E.	Valid	Increment word register by 1.
40+ <i>rd</i>	INC <i>r32</i>	O	N.E.	Valid	Increment doubleword register by 1.

### NOTES:

\* In 64-bit mode, *r/m8* can not be encoded to access the following byte registers if a REX prefix is used: AH, BH, CH, DH.

\*\* 40H through 47H are REX prefixes in 64-bit mode.

### Instruction Operand Encoding

Op/En	Operand 1	Operand 2	Operand 3	Operand 4
M	ModRM: <i>r/m</i> ( <i>r</i> , <i>w</i> )	NA	NA	NA
O	opcode + <i>rd</i> ( <i>r</i> , <i>w</i> )	NA	NA	NA

### Description

Adds 1 to the destination operand, while preserving the state of the CF flag. The destination operand can be a register or a memory location. This instruction allows a loop counter to be updated without disturbing the CF flag. (Use a ADD instruction with an immediate operand of 1 to perform an increment operation that does updates the CF flag.)

This instruction can be used with a LOCK prefix to allow the instruction to be executed atomically.

In 64-bit mode, INC *r16* and INC *r32* are not encodable (because opcodes 40H through 47H are REX prefixes). Otherwise, the instruction's 64-bit mode default operation size is 32 bits. Use of the REX.R prefix permits access to additional registers (R8-R15). Use of the REX.W prefix promotes operation to 64 bits.

### Operation

DEST ← DEST + 1;

### AFlags Affected

The CF flag is not affected. The OF, SF, ZF, AF, and PF flags are set according to the result.

### Protected Mode Exceptions

#GP(0)	If the destination operand is located in a non-writable segment. If a memory operand effective address is outside the CS, DS, ES, FS, or GS segment limit. If the DS, ES, FS, or GS register is used to access memory and it contains a NULLsegment selector.
#SS(0)	If a memory operand effective address is outside the SS segment limit.
#PF(fault-code)	If a page fault occurs.
#AC(0)	If alignment checking is enabled and an unaligned memory reference is made while the current privilege level is 3.
#UD	If the LOCK prefix is used but the destination is not a memory operand.

**Real-Address Mode Exceptions**

#GP	If a memory operand effective address is outside the CS, DS, ES, FS, or GS segment limit.
#SS	If a memory operand effective address is outside the SS segment limit.
#UD	If the LOCK prefix is used but the destination is not a memory operand.

**Virtual-8086 Mode Exceptions**

#GP(0)	If a memory operand effective address is outside the CS, DS, ES, FS, or GS segment limit.
#SS(0)	If a memory operand effective address is outside the SS segment limit.
#PF(fault-code)	If a page fault occurs.
#AC(0)	If alignment checking is enabled and an unaligned memory reference is made.
#UD	If the LOCK prefix is used but the destination is not a memory operand.

**Compatibility Mode Exceptions**

Same exceptions as in protected mode.

**64-Bit Mode Exceptions**

#SS(0)	If a memory address referencing the SS segment is in a non-canonical form.
#GP(0)	If the memory address is in a non-canonical form.
#PF(fault-code)	If a page fault occurs.
#AC(0)	If alignment checking is enabled and an unaligned memory reference is made while the current privilege level is 3.
#UD	If the LOCK prefix is used but the destination is not a memory operand.

## INS/INSB/INSW/INSD—Input from Port to String

Opcode	Instruction	Op/En	64-Bit Mode	Compat/Leg Mode	Description
6C	INS <i>m8</i> , DX	Z0	Valid	Valid	Input byte from I/O port specified in DX into memory location specified in ES:(E)DI or RDI.*
6D	INS <i>m16</i> , DX	Z0	Valid	Valid	Input word from I/O port specified in DX into memory location specified in ES:(E)DI or RDI. <sup>1</sup>
6D	INS <i>m32</i> , DX	Z0	Valid	Valid	Input doubleword from I/O port specified in DX into memory location specified in ES:(E)DI or RDI. <sup>1</sup>
6C	INSB	Z0	Valid	Valid	Input byte from I/O port specified in DX into memory location specified with ES:(E)DI or RDI. <sup>1</sup>
6D	INSW	Z0	Valid	Valid	Input word from I/O port specified in DX into memory location specified in ES:(E)DI or RDI. <sup>1</sup>
6D	INSD	Z0	Valid	Valid	Input doubleword from I/O port specified in DX into memory location specified in ES:(E)DI or RDI. <sup>1</sup>

### NOTES:

\* In 64-bit mode, only 64-bit (RDI) and 32-bit (EDI) address sizes are supported. In non-64-bit mode, only 32-bit (EDI) and 16-bit (DI) address sizes are supported.

### Instruction Operand Encoding

Op/En	Operand 1	Operand 2	Operand 3	Operand 4
Z0	NA	NA	NA	NA

### Description

Copies the data from the I/O port specified with the source operand (second operand) to the destination operand (first operand). The source operand is an I/O port address (from 0 to 65,535) that is read from the DX register. The destination operand is a memory location, the address of which is read from either the ES:DI, ES:EDI or the RDI registers (depending on the address-size attribute of the instruction, 16, 32 or 64, respectively). (The ES segment cannot be overridden with a segment override prefix.) The size of the I/O port being accessed (that is, the size of the source and destination operands) is determined by the opcode for an 8-bit I/O port or by the operand-size attribute of the instruction for a 16- or 32-bit I/O port.

At the assembly-code level, two forms of this instruction are allowed: the “explicit-operands” form and the “no-operands” form. The explicit-operands form (specified with the INS mnemonic) allows the source and destination operands to be specified explicitly. Here, the source operand must be “DX,” and the destination operand should be a symbol that indicates the size of the I/O port and the destination address. This explicit-operands form is provided to allow documentation; however, note that the documentation provided by this form can be misleading. That is, the destination operand symbol must specify the correct **type** (size) of the operand (byte, word, or doubleword), but it does not have to specify the correct **location**. The location is always specified by the ES:(E)DI registers, which must be loaded correctly before the INS instruction is executed.

The no-operands form provides “short forms” of the byte, word, and doubleword versions of the INS instructions. Here also DX is assumed by the processor to be the source operand and ES:(E)DI is assumed to be the destination operand. The size of the I/O port is specified with the choice of mnemonic: INSB (byte), INSW (word), or INSD (doubleword).

After the byte, word, or doubleword is transfer from the I/O port to the memory location, the DI/EDI/RDI register is incremented or decremented automatically according to the setting of the DF flag in the EFLAGS register. (If the DF flag is 0, the (E)DI register is incremented; if the DF flag is 1, the (E)DI register is decremented.) The (E)DI register is incremented or decremented by 1 for byte operations, by 2 for word operations, or by 4 for doubleword operations.

The INS, INSB, INSW, and INSD instructions can be preceded by the REP prefix for block input of ECX bytes, words, or doublewords. See “REP/REPE/REPZ /REPNE/REP NZ—Repeat String Operation Prefix” in Chapter 4 of the *Intel® 64 and IA-32 Architectures Software Developer’s Manual, Volume 2B*, for a description of the REP prefix.

These instructions are only useful for accessing I/O ports located in the processor’s I/O address space. See Chapter 18, “Input/Output,” in the *Intel® 64 and IA-32 Architectures Software Developer’s Manual, Volume 1*, for more information on accessing I/O ports in the I/O address space.

In 64-bit mode, default address size is 64 bits, 32 bit address size is supported using the prefix 67H. The address of the memory destination is specified by RDI or EDI. 16-bit address size is not supported in 64-bit mode. The operand size is not promoted.

These instructions may read from the I/O port without writing to the memory location if an exception or VM exit occurs due to the write (e.g. #PF). If this would be problematic, for example because the I/O port read has side-effects, software should ensure the write to the memory location does not cause an exception or VM exit.

## Operation

```
IF ((PE = 1) and ((CPL > IOPL) or (VM = 1)))
  THEN (* Protected mode with CPL > IOPL or virtual-8086 mode *)
    IF (Any I/O Permission Bit for I/O port being accessed = 1)
      THEN (* I/O operation is not allowed *)
        #GP(0);
      ELSE (* I/O operation is allowed *)
        DEST ← SRC; (* Read from I/O port *)
    FI;
  ELSE (Real Mode or Protected Mode with CPL IOPL *)
    DEST ← SRC; (* Read from I/O port *)
  FI;
```

Non-64-bit Mode:

```
IF (Byte transfer)
  THEN IF DF = 0
    THEN (E)DI ← (E)DI + 1;
    ELSE (E)DI ← (E)DI - 1; FI;
  ELSE IF (Word transfer)
    THEN IF DF = 0
      THEN (E)DI ← (E)DI + 2;
      ELSE (E)DI ← (E)DI - 2; FI;
    ELSE (* Doubleword transfer *)
      THEN IF DF = 0
        THEN (E)DI ← (E)DI + 4;
        ELSE (E)DI ← (E)DI - 4; FI;
    FI;
  FI;
```

FI64-bit Mode:

```
IF (Byte transfer)
  THEN IF DF = 0
    THEN (E|R)DI ← (E|R)DI + 1;
    ELSE (E|R)DI ← (E|R)DI - 1; FI;
  ELSE IF (Word transfer)
    THEN IF DF = 0
      THEN (E)DI ← (E)DI + 2;
      ELSE (E)DI ← (E)DI - 2; FI;
    ELSE (* Doubleword transfer *)
```

```

    THEN IF DF = 0
      THEN (E|R)DI ← (E|R)DI + 4;
      ELSE (E|R)DI ← (E|R)DI - 4; FI;
  FI;
FI;

```

### Flags Affected

None

### Protected Mode Exceptions

#GP(0)	If the CPL is greater than (has less privilege) the I/O privilege level (IOPL) and any of the corresponding I/O permission bits in TSS for the I/O port being accessed is 1. If the destination is located in a non-writable segment. If an illegal memory operand effective address in the ES segments is given.
#PF(fault-code)	If a page fault occurs.
#AC(0)	If alignment checking is enabled and an unaligned memory reference is made while the current privilege level is 3.
#UD	If the LOCK prefix is used.

### Real-Address Mode Exceptions

#GP	If a memory operand effective address is outside the CS, DS, ES, FS, or GS segment limit.
#SS	If a memory operand effective address is outside the SS segment limit.
#UD	If the LOCK prefix is used.

### Virtual-8086 Mode Exceptions

#GP(0)	If any of the I/O permission bits in the TSS for the I/O port being accessed is 1.
#PF(fault-code)	If a page fault occurs.
#AC(0)	If alignment checking is enabled and an unaligned memory reference is made.
#UD	If the LOCK prefix is used.

### Compatibility Mode Exceptions

Same exceptions as in protected mode.

### 64-Bit Mode Exceptions

#SS(0)	If a memory address referencing the SS segment is in a non-canonical form.
#GP(0)	If the CPL is greater than (has less privilege) the I/O privilege level (IOPL) and any of the corresponding I/O permission bits in TSS for the I/O port being accessed is 1. If the memory address is in a non-canonical form.
#PF(fault-code)	If a page fault occurs.
#AC(0)	If alignment checking is enabled and an unaligned memory reference is made while the current privilege level is 3.
#UD	If the LOCK prefix is used.

## INSERTPS—Insert Scalar Single-Precision Floating-Point Value

Opcode/ Instruction	Op / En	64/32 bit Mode Support	CPUID Feature Flag	Description
66 0F 3A 21 /r ib INSERTPS xmm1, xmm2/m32, imm8	A	V/V	SSE4_1	Insert a single-precision floating-point value selected by imm8 from xmm2/m32 into xmm1 at the specified destination element specified by imm8 and zero out destination elements in xmm1 as indicated in imm8.
VEX.NDS.128.66.0F3A.WIG 21 /r ib VINSERTPS xmm1, xmm2, xmm3/m32, imm8	B	V/V	AVX	Insert a single-precision floating-point value selected by imm8 from xmm3/m32 and merge with values in xmm2 at the specified destination element specified by imm8 and write out the result and zero out destination elements in xmm1 as indicated in imm8.
EVEX.NDS.128.66.0F3A.W0 21 /r ib VINSERTPS xmm1, xmm2, xmm3/m32, imm8	C	V/V	AVX512F	Insert a single-precision floating-point value selected by imm8 from xmm3/m32 and merge with values in xmm2 at the specified destination element specified by imm8 and write out the result and zero out destination elements in xmm1 as indicated in imm8.

### Instruction Operand Encoding

Op/En	Tuple Type	Operand 1	Operand 2	Operand 3	Operand 4
A	NA	ModRM:reg (r, w)	ModRM:r/m (r)	Imm8	NA
B	NA	ModRM:reg (w)	VEX.vvvv	ModRM:r/m (r)	Imm8
C	Tuple1 Scalar	ModRM:reg (w)	EVEX.vvvv	ModRM:r/m (r)	Imm8

### Description

(register source form)

Copy a single-precision scalar floating-point element into a 128-bit vector register. The immediate operand has three fields, where the ZMask bits specify which elements of the destination will be set to zero, the Count\_D bits specify which element of the destination will be overwritten with the scalar value, and for vector register sources the Count\_S bits specify which element of the source will be copied. When the scalar source is a memory operand the Count\_S bits are ignored.

(memory source form)

Load a floating-point element from a 32-bit memory location and destination operand it into the first source at the location indicated by the Count\_D bits of the immediate operand. Store in the destination and zero out destination elements based on the ZMask bits of the immediate operand.

128-bit Legacy SSE version: The first source register is an XMM register. The second source operand is either an XMM register or a 32-bit memory location. The destination is not distinct from the first source XMM register and the upper bits (MAXVL-1:128) of the corresponding register destination are unmodified.

VEX.128 and EVEX encoded version: The destination and first source register is an XMM register. The second source operand is either an XMM register or a 32-bit memory location. The upper bits (MAXVL-1:128) of the corresponding register destination are zeroed.

If VINSERTPS is encoded with VEX.L= 1, an attempt to execute the instruction encoded with VEX.L= 1 will cause an #UD exception.

**Operation****VINSERTPS (VEX.128 and EVEX encoded version)**

```

IF (SRC = REG) THEN COUNT_S ← imm8[7:6]
  ELSE COUNT_S ← 0
COUNT_D ← imm8[5:4]
ZMASK ← imm8[3:0]
CASE (COUNT_S) OF
  0: TMP ← SRC2[31:0]
  1: TMP ← SRC2[63:32]
  2: TMP ← SRC2[95:64]
  3: TMP ← SRC2[127:96]
ESAC;
CASE (COUNT_D) OF
  0: TMP2[31:0] ← TMP
      TMP2[127:32] ← SRC1[127:32]
  1: TMP2[63:32] ← TMP
      TMP2[31:0] ← SRC1[31:0]
      TMP2[127:64] ← SRC1[127:64]
  2: TMP2[95:64] ← TMP
      TMP2[63:0] ← SRC1[63:0]
      TMP2[127:96] ← SRC1[127:96]
  3: TMP2[127:96] ← TMP
      TMP2[95:0] ← SRC1[95:0]
ESAC;

IF (ZMASK[0] = 1) THEN DEST[31:0] ← 00000000H
  ELSE DEST[31:0] ← TMP2[31:0]
IF (ZMASK[1] = 1) THEN DEST[63:32] ← 00000000H
  ELSE DEST[63:32] ← TMP2[63:32]
IF (ZMASK[2] = 1) THEN DEST[95:64] ← 00000000H
  ELSE DEST[95:64] ← TMP2[95:64]
IF (ZMASK[3] = 1) THEN DEST[127:96] ← 00000000H
  ELSE DEST[127:96] ← TMP2[127:96]
DEST[MAXVL-1:128] ← 0

```

**INSERTPS (128-bit Legacy SSE version)**

```

IF (SRC = REG) THEN COUNT_S ← imm8[7:6]
  ELSE COUNT_S ← 0
COUNT_D ← imm8[5:4]
ZMASK ← imm8[3:0]
CASE (COUNT_S) OF
  0: TMP ← SRC[31:0]
  1: TMP ← SRC[63:32]
  2: TMP ← SRC[95:64]
  3: TMP ← SRC[127:96]
ESAC;

CASE (COUNT_D) OF
  0: TMP2[31:0] ← TMP
      TMP2[127:32] ← DEST[127:32]
  1: TMP2[63:32] ← TMP
      TMP2[31:0] ← DEST[31:0]
      TMP2[127:64] ← DEST[127:64]
  2: TMP2[95:64] ← TMP

```



```

    TMP2[63:0] ←DEST[63:0]
    TMP2[127:96] ←DEST[127:96]
3: TMP2[127:96] ←TMP
    TMP2[95:0] ←DEST[95:0]

```

ESAC;

```

IF (ZMASK[0] = 1) THEN DEST[31:0] ←00000000H
    ELSE DEST[31:0] ←TMP2[31:0]
IF (ZMASK[1] = 1) THEN DEST[63:32] ←00000000H
    ELSE DEST[63:32] ←TMP2[63:32]
IF (ZMASK[2] = 1) THEN DEST[95:64] ←00000000H
    ELSE DEST[95:64] ←TMP2[95:64]
IF (ZMASK[3] = 1) THEN DEST[127:96] ←00000000H
    ELSE DEST[127:96] ←TMP2[127:96]
DEST[MAXVL-1:128] (Unmodified)

```

### Intel C/C++ Compiler Intrinsic Equivalent

```

VINSERTPS __m128 _mm_insert_ps(__m128 dst, __m128 src, const int nidx);
INSETRTPS __m128 _mm_insert_ps(__m128 dst, __m128 src, const int nidx);

```

### SIMD Floating-Point Exceptions

None

### Other Exceptions

Non-EVEX-encoded instruction, see Exceptions Type 5; additionally

#UD If VEX.L = 0.

EVEX-encoded instruction, see Exceptions Type E9NF.

## INT *n*/INTO/INT 3—Call to Interrupt Procedure

Opcode	Instruction	Op/En	64-Bit Mode	Compat/Leg Mode	Description
CC	INT 3	Z0	Valid	Valid	Interrupt 3—trap to debugger.
CD <i>ib</i>	INT <i>imm8</i>	I	Valid	Valid	Interrupt vector specified by immediate byte.
CE	INTO	Z0	Invalid	Valid	Interrupt 4—if overflow flag is 1.

### Instruction Operand Encoding

Op/En	Operand 1	Operand 2	Operand 3	Operand 4
Z0	NA	NA	NA	NA
I	imm8	NA	NA	NA

### Description

The INT *n* instruction generates a call to the interrupt or exception handler specified with the destination operand (see the section titled “Interrupts and Exceptions” in Chapter 6 of the *Intel® 64 and IA-32 Architectures Software Developer’s Manual, Volume 1*). The destination operand specifies a vector from 0 to 255, encoded as an 8-bit unsigned intermediate value. Each vector provides an index to a gate descriptor in the IDT. The first 32 vectors are reserved by Intel for system use. Some of these vectors are used for internally generated exceptions.

The INT *n* instruction is the general mnemonic for executing a software-generated call to an interrupt handler. The INTO instruction is a special mnemonic for calling overflow exception (#OF), exception 4. The overflow interrupt checks the OF flag in the EFLAGS register and calls the overflow interrupt handler if the OF flag is set to 1. (The INTO instruction cannot be used in 64-bit mode.)

The INT 3 instruction generates a special one byte opcode (CC) that is intended for calling the debug exception handler. (This one byte form is valuable because it can be used to replace the first byte of any instruction with a breakpoint, including other one byte instructions, without over-writing other code).

An interrupt generated by INTO or INT3 (CC) differs from one generated by INT *n* in the following ways:

- The normal IOPL checks do not occur in virtual-8086 mode. The interrupt is taken (without fault) with any IOPL value.
- The interrupt redirection enabled by the virtual-8086 mode extensions (VME) does not occur. The interrupt is always handled by a protected-mode handler.

(These features do not pertain to CD03, the “normal” 2-byte opcode for INT 3. Intel and Microsoft assemblers will not generate the CD03 opcode from any mnemonic, but this opcode can be created by direct numeric code definition or by self-modifying code.)

The action of the INT *n* instruction (including the INTO and INT 3 instructions) is similar to that of a far call made with the CALL instruction. The primary difference is that with the INT *n* instruction, the EFLAGS register is pushed onto the stack before the return address. (The return address is a far address consisting of the current values of the CS and EIP registers.) Returns from interrupt procedures are handled with the IRET instruction, which pops the EFLAGS information and return address from the stack.

The vector specifies an interrupt descriptor in the interrupt descriptor table (IDT); that is, it provides index into the IDT. The selected interrupt descriptor in turn contains a pointer to an interrupt or exception handler procedure. In protected mode, the IDT contains an array of 8-byte descriptors, each of which is an interrupt gate, trap gate, or task gate. In real-address mode, the IDT is an array of 4-byte far pointers (2-byte code segment selector and a 2-byte instruction pointer), each of which point directly to a procedure in the selected segment. (Note that in real-address mode, the IDT is called the **interrupt vector table**, and its pointers are called **interrupt vectors**.)

The following decision table indicates which action in the lower portion of the table is taken given the conditions in the upper portion of the table. Each Y in the lower section of the decision table represents a procedure defined in the “Operation” section for this instruction (except #GP).

Table 3-51. Decision Table

PE	0	1	1	1	1	1	1	1
VM	-	-	-	-	-	0	1	1
IOPL	-	-	-	-	-	-	<3	=3
DPL/CPL RELATIONSHIP	-	DPL < CPL	-	DPL > CPL	DPL = CPL or C	DPL < CPL & NC	-	-
INTERRUPT TYPE	-	S/W	-	-	-	-	-	-
GATE TYPE	-	-	Task	Trap or Interrupt	Trap or Interrupt	Trap or Interrupt	Trap or Interrupt	Trap or Interrupt
REAL-ADDRESS-MODE	Y							
PROTECTED-MODE		Y	Y	Y	Y	Y	Y	Y
TRAP-OR-INTERRUPT-GATE				Y	Y	Y	Y	Y
INTER-PRIVILEGE-LEVEL-INTERRUPT						Y		
INTRA-PRIVILEGE-LEVEL-INTERRUPT					Y			
INTERRUPT-FROM-VIRTUAL-8086-MODE								Y
TASK-GATE			Y					
#GP		Y		Y			Y	

**NOTES:**

- Don't Care.
- Y Yes, action taken.
- Blank Action not taken.

When the processor is executing in virtual-8086 mode, the IOPL determines the action of the INT *n* instruction. If the IOPL is less than 3, the processor generates a #GP(selector) exception; if the IOPL is 3, the processor executes a protected mode interrupt to privilege level 0. The interrupt gate's DPL must be set to 3 and the target CPL of the interrupt handler procedure must be 0 to execute the protected mode interrupt to privilege level 0.

The interrupt descriptor table register (IDTR) specifies the base linear address and limit of the IDT. The initial base address value of the IDTR after the processor is powered up or reset is 0.

**Operation**

The following operational description applies not only to the INT *n* and INTO instructions, but also to external interrupts, nonmaskable interrupts (NMIs), and exceptions. Some of these events push onto the stack an error code.

The operational description specifies numerous checks whose failure may result in delivery of a nested exception. In these cases, the original event is not delivered.

The operational description specifies the error code delivered by any nested exception. In some cases, the error code is specified with a pseudofunction `error_code(num, idt, ext)`, where `idt` and `ext` are bit values. The pseudofunction produces an error code as follows: (1) if `idt` is 0, the error code is  $(\text{num} \& \text{FCH}) \mid \text{ext}$ ; (2) if `idt` is 1, the error code is  $(\text{num} \ll 3) \mid 2 \mid \text{ext}$ .

In many cases, the pseudofunction `error_code` is invoked with a pseudovisible `EXT`. The value of `EXT` depends on the nature of the event whose delivery encountered a nested exception: if that event is a software interrupt, `EXT` is 0; otherwise, `EXT` is 1.

```

IF PE = 0
  THEN
    GOTO REAL-ADDRESS-MODE;
  ELSE (* PE = 1 *)
    IF (EFLAGS.VM = 1 AND CR4.VME = 0 AND IOPL < 3 AND INT n)
      THEN
        #GP(0); (* Bit 0 of error code is 0 because INT n *)
      ELSE
        IF (EFLAGS.VM = 1 AND CR4.VME = 1 AND INT n)
          THEN
            Consult bit n of the software interrupt redirection bit map in the TSS;
            IF bit n is clear
              THEN (* redirect interrupt to 8086 program interrupt handler *)
                Push EFLAGS[15:0]; (* if IOPL < 3, save VIF in IF position and save IOPL position as 3 *)
                Push CS;
                Push IP;
                IF IOPL = 3
                  THEN IF ← 0; (* Clear interrupt flag *)
                  ELSE VIF ← 0; (* Clear virtual interrupt flag *)
                FI;
                TF ← 0; (* Clear trap flag *)
                load CS and EIP (lower 16 bits only) from entry n in interrupt vector table referenced from TSS;
              ELSE
                IF IOPL = 3
                  THEN GOTO PROTECTED-MODE;
                  ELSE #GP(0); (* Bit 0 of error code is 0 because INT n *)
                FI;
            ELSE (* Protected mode, IA-32e mode, or virtual-8086 mode interrupt *)
              IF (IA32_EFER.LMA = 0)
                THEN (* Protected mode, or virtual-8086 mode interrupt *)
                  GOTO PROTECTED-MODE;
                ELSE (* IA-32e mode interrupt *)
                  GOTO IA-32e-MODE;
              FI;
          FI;
        FI;
    FI;
  REAL-ADDRESS-MODE:
    IF ((vector_number << 2) + 3) is not within IDT limit
      THEN #GP; FI;
    IF stack not large enough for a 6-byte return information
      THEN #SS; FI;
    Push (EFLAGS[15:0]);
    IF ← 0; (* Clear interrupt flag *)
    TF ← 0; (* Clear trap flag *)
    AC ← 0; (* Clear AC flag *)
    Push(CS);
    Push(IP);
    (* No error codes are pushed in real-address mode*)
    CS ← IDT(Descriptor (vector_number << 2), selector);
    EIP ← IDT(Descriptor (vector_number << 2), offset); (* 16 bit offset AND 0000FFFFH *)
  END;
  PROTECTED-MODE:

```

```

IF ((vector_number << 3) + 7) is not within IDT limits
or selected IDT descriptor is not an interrupt-, trap-, or task-gate type
  THEN #GP(error_code(vector_number,1,EXT)); FI;
  (* idt operand to error_code set because vector is used *)
IF software interrupt (* Generated by INT n, INT3, or INTO *)
  THEN
  IF gate DPL < CPL (* PE = 1, DPL < CPL, software interrupt *)
    THEN #GP(error_code(vector_number,1,0)); FI;
    (* idt operand to error_code set because vector is used *)
    (* ext operand to error_code is 0 because INT n, INT3, or INTO*)
  FI;
IF gate not present
  THEN #NP(error_code(vector_number,1,EXT)); FI;
  (* idt operand to error_code set because vector is used *)
IF task gate (* Specified in the selected interrupt table descriptor *)
  THEN GOTO TASK-GATE;
  ELSE GOTO TRAP-OR-INTERRUPT-GATE; (* PE = 1, trap/interrupt gate *)
  FI;
END;
IA-32e-MODE:
IF INTO and CS.L = 1 (64-bit mode)
  THEN #UD;
  FI;
IF ((vector_number << 4) + 15) is not in IDT limits
or selected IDT descriptor is not an interrupt-, or trap-gate type
  THEN #GP(error_code(vector_number,1,EXT));
  (* idt operand to error_code set because vector is used *)
  FI;
IF software interrupt (* Generated by INT n, INT 3, or INTO *)
  THEN
  IF gate DPL < CPL (* PE = 1, DPL < CPL, software interrupt *)
    THEN #GP(error_code(vector_number,1,0));
    (* idt operand to error_code set because vector is used *)
    (* ext operand to error_code is 0 because INT n, INT3, or INTO*)
  FI;
  FI;
IF gate not present
  THEN #NP(error_code(vector_number,1,EXT));
  (* idt operand to error_code set because vector is used *)
  FI;
  GOTO TRAP-OR-INTERRUPT-GATE; (* Trap/interrupt gate *)
END;
TASK-GATE: (* PE = 1, task gate *)
  Read TSS selector in task gate (IDT descriptor);
  IF local/global bit is set to local or index not within GDT limits
    THEN #GP(error_code(TSS selector,0,EXT)); FI;
    (* idt operand to error_code is 0 because selector is used *)
  Access TSS descriptor in GDT;
  IF TSS descriptor specifies that the TSS is busy (low-order 5 bits set to 00001)
    THEN #GP(TSS selector,0,EXT)); FI;
    (* idt operand to error_code is 0 because selector is used *)
  IF TSS not present
    THEN #NP(TSS selector,0,EXT)); FI;
    (* idt operand to error_code is 0 because selector is used *)

```

```

SWITCH-TASKS (with nesting) to TSS;
IF interrupt caused by fault with error code
    THEN
        IF stack limit does not allow push of error code
            THEN #SS(EXT); FI;
        Push(error code);
    FI;
IF EIP not within code segment limit
    THEN #GP(EXT); FI;
END;
TRAP-OR-INTERRUPT-GATE:
Read new code-segment selector for trap or interrupt gate (IDT descriptor);
IF new code-segment selector is NULL
    THEN #GP(EXT); FI; (* Error code contains NULL selector *)
IF new code-segment selector is not within its descriptor table limits
    THEN #GP(error_code(new code-segment selector,0,EXT)); FI;
    (* idt operand to error_code is 0 because selector is used *)
Read descriptor referenced by new code-segment selector;
IF descriptor does not indicate a code segment or new code-segment DPL > CPL
    THEN #GP(error_code(new code-segment selector,0,EXT)); FI;
    (* idt operand to error_code is 0 because selector is used *)
IF new code-segment descriptor is not present,
    THEN #NP(error_code(new code-segment selector,0,EXT)); FI;
    (* idt operand to error_code is 0 because selector is used *)
IF new code segment is non-conforming with DPL < CPL
    THEN
        IF VM = 0
            THEN
                GOTO INTER-PRIVILEGE-LEVEL-INTERRUPT;
                (* PE = 1, VM = 0, interrupt or trap gate, nonconforming code segment,
                DPL < CPL *)
            ELSE (* VM = 1 *)
                IF new code-segment DPL ≠ 0
                    THEN #GP(error_code(new code-segment selector,0,EXT));
                    (* idt operand to error_code is 0 because selector is used *)
                GOTO INTERRUPT-FROM-VIRTUAL-8086-MODE; FI;
                (* PE = 1, interrupt or trap gate, DPL < CPL, VM = 1 *)
            FI;
        ELSE (* PE = 1, interrupt or trap gate, DPL ≥ CPL *)
            IF VM = 1
                THEN #GP(error_code(new code-segment selector,0,EXT));
                (* idt operand to error_code is 0 because selector is used *)
            IF new code segment is conforming or new code-segment DPL = CPL
                THEN
                    GOTO INTRA-PRIVILEGE-LEVEL-INTERRUPT;
                ELSE (* PE = 1, interrupt or trap gate, nonconforming code segment, DPL > CPL *)
                    #GP(error_code(new code-segment selector,0,EXT));
                    (* idt operand to error_code is 0 because selector is used *)
                FI;
            FI;
        END;
INTER-PRIVILEGE-LEVEL-INTERRUPT:
    (* PE = 1, interrupt or trap gate, non-conforming code segment, DPL < CPL *)
    IF (IA32_EFER.LMA = 0) (* Not IA-32e mode *)

```

```

THEN
(* Identify stack-segment selector for new privilege level in current TSS *)
  IF current TSS is 32-bit
    THEN
      TSSstackAddress ← (new code-segment DPL << 3) + 4;
      IF (TSSstackAddress + 5) > current TSS limit
        THEN #TS(error_code(current TSS selector,0,EXT)); FI;
        (* idt operand to error_code is 0 because selector is used *)
      NewSS ← 2 bytes loaded from (TSS base + TSSstackAddress + 4);
      NewESP ← 4 bytes loaded from (TSS base + TSSstackAddress);
    ELSE (* current TSS is 16-bit *)
      TSSstackAddress ← (new code-segment DPL << 2) + 2
      IF (TSSstackAddress + 3) > current TSS limit
        THEN #TS(error_code(current TSS selector,0,EXT)); FI;
        (* idt operand to error_code is 0 because selector is used *)
      NewSS ← 2 bytes loaded from (TSS base + TSSstackAddress + 2);
      NewESP ← 2 bytes loaded from (TSS base + TSSstackAddress);
    FI;
  IF NewSS is NULL
    THEN #TS(EXT); FI;
  IF NewSS index is not within its descriptor-table limits
  or NewSS RPL ≠ new code-segment DPL
    THEN #TS(error_code(NewSS,0,EXT)); FI;
    (* idt operand to error_code is 0 because selector is used *)
  Read new stack-segment descriptor for NewSS in GDT or LDT;
  IF new stack-segment DPL ≠ new code-segment DPL
  or new stack-segment Type does not indicate writable data segment
    THEN #TS(error_code(NewSS,0,EXT)); FI;
    (* idt operand to error_code is 0 because selector is used *)
  IF NewSS is not present
    THEN #SS(error_code(NewSS,0,EXT)); FI;
    (* idt operand to error_code is 0 because selector is used *)
ELSE (* IA-32e mode *)
  IF IDT-gate IST = 0
    THEN TSSstackAddress ← (new code-segment DPL << 3) + 4;
    ELSE TSSstackAddress ← (IDT gate IST << 3) + 28;
  FI;
  IF (TSSstackAddress + 7) > current TSS limit
    THEN #TS(error_code(current TSS selector,0,EXT)); FI;
    (* idt operand to error_code is 0 because selector is used *)
  NewRSP ← 8 bytes loaded from (current TSS base + TSSstackAddress);
  NewSS ← new code-segment DPL; (* NULL selector with RPL = new CPL *)
FI;
IF IDT gate is 32-bit
  THEN
    IF new stack does not have room for 24 bytes (error code pushed)
    or 20 bytes (no error code pushed)
      THEN #SS(error_code(NewSS,0,EXT)); FI;
      (* idt operand to error_code is 0 because selector is used *)
    FI
  ELSE
    IF IDT gate is 16-bit
      THEN
        IF new stack does not have room for 12 bytes (error code pushed)

```

```

        or 10 bytes (no error code pushed);
        THEN #SS(error_code(NewSS,0,EXT)); FI;
        (* idt operand to error_code is 0 because selector is used *)
ELSE (* 64-bit IDT gate*)
    IF StackAddress is non-canonical
        THEN #SS(EXT); FI; (* Error code contains NULL selector *)
FI;
FI;
IF (IA32_EFER.LMA = 0) (* Not IA-32e mode *)
    THEN
        IF instruction pointer from IDT gate is not within new code-segment limits
            THEN #GP(EXT); FI; (* Error code contains NULL selector *)
        ESP ← NewESP;
        SS ← NewSS; (* Segment descriptor information also loaded *)
    ELSE (* IA-32e mode *)
        IF instruction pointer from IDT gate contains a non-canonical address
            THEN #GP(EXT); FI; (* Error code contains NULL selector *)
        RSP ← NewRSP & FFFFFFFF0H;
        SS ← NewSS;
FI;
IF IDT gate is 32-bit
    THEN
        CS:EIP ← Gate(CS:EIP); (* Segment descriptor information also loaded *)
    ELSE
        IF IDT gate 16-bit
            THEN
                CS:IP ← Gate(CS:IP);
                (* Segment descriptor information also loaded *)
            ELSE (* 64-bit IDT gate *)
                CS:RIP ← Gate(CS:RIP);
                (* Segment descriptor information also loaded *)
        FI;
FI;
IF IDT gate is 32-bit
    THEN
        Push(far pointer to old stack);
        (* Old SS and ESP, 3 words padded to 4 *)
        Push(EFLAGS);
        Push(far pointer to return instruction);
        (* Old CS and EIP, 3 words padded to 4 *)
        Push(ErrorCode); (* If needed, 4 bytes *)
    ELSE
        IF IDT gate 16-bit
            THEN
                Push(far pointer to old stack);
                (* Old SS and SP, 2 words *)
                Push(EFLAGS(15-0));
                Push(far pointer to return instruction);
                (* Old CS and IP, 2 words *)
                Push(ErrorCode); (* If needed, 2 bytes *)
            ELSE (* 64-bit IDT gate *)
                Push(far pointer to old stack);
                (* Old SS and SP, each an 8-byte push *)
                Push(RFLAGS); (* 8-byte push *)

```



```

        Push(far pointer to return instruction);
        (* Old CS and RIP, each an 8-byte push *)
        Push(ErrorCode); (* If needed, 8-bytes *)
    FI;
FI;
CPL ← new code-segment DPL;
CS(RPL) ← CPL;
IF IDT gate is interrupt gate
    THEN IF ← 0 (* Interrupt flag set to 0, interrupts disabled *); FI;
TF ← 0;
VM ← 0;
RF ← 0;
NT ← 0;
END;
INTERRUPT-FROM-VIRTUAL-8086-MODE:
(* Identify stack-segment selector for privilege level 0 in current TSS *)
IF current TSS is 32-bit
    THEN
        IF TSS limit < 9
            THEN #TS(error_code(current TSS selector,0,EXT)); FI;
            (* idt operand to error_code is 0 because selector is used *)
            NewSS ← 2 bytes loaded from (current TSS base + 8);
            NewESP ← 4 bytes loaded from (current TSS base + 4);
        ELSE (* current TSS is 16-bit *)
            IF TSS limit < 5
                THEN #TS(error_code(current TSS selector,0,EXT)); FI;
                (* idt operand to error_code is 0 because selector is used *)
                NewSS ← 2 bytes loaded from (current TSS base + 4);
                NewESP ← 2 bytes loaded from (current TSS base + 2);
        FI;
    IF NewSS is NULL
        THEN #TS(EXT); FI; (* Error code contains NULL selector *)
    IF NewSS index is not within its descriptor table limits
    or NewSS RPL ≠ 0
        THEN #TS(error_code(NewSS,0,EXT)); FI;
        (* idt operand to error_code is 0 because selector is used *)
    Read new stack-segment descriptor for NewSS in GDT or LDT;
    IF new stack-segment DPL ≠ 0 or stack segment does not indicate writable data segment
        THEN #TS(error_code(NewSS,0,EXT)); FI;
        (* idt operand to error_code is 0 because selector is used *)
    IF new stack segment not present
        THEN #SS(error_code(NewSS,0,EXT)); FI;
        (* idt operand to error_code is 0 because selector is used *)
    IF IDT gate is 32-bit
        THEN
            IF new stack does not have room for 40 bytes (error code pushed)
            or 36 bytes (no error code pushed)
                THEN #SS(error_code(NewSS,0,EXT)); FI;
                (* idt operand to error_code is 0 because selector is used *)
            ELSE (* IDT gate is 16-bit *)
                IF new stack does not have room for 20 bytes (error code pushed)
                or 18 bytes (no error code pushed)
                    THEN #SS(error_code(NewSS,0,EXT)); FI;
                    (* idt operand to error_code is 0 because selector is used *)

```

```

FI;
IF instruction pointer from IDT gate is not within new code-segment limits
    THEN #GP(EXT); FI; (* Error code contains NULL selector *)
tempEFLAGS ← EFLAGS;
VM ← 0;
TF ← 0;
RF ← 0;
NT ← 0;
IF service through interrupt gate
    THEN IF = 0; FI;
TempSS ← SS;
TempESP ← ESP;
SS ← NewSS;
ESP ← NewESP;
(* Following pushes are 16 bits for 16-bit IDT gates and 32 bits for 32-bit IDT gates;
Segment selector pushes in 32-bit mode are padded to two words *)
Push(GS);
Push(FS);
Push(DS);
Push(ES);
Push(TempSS);
Push(TempESP);
Push(TempEFlags);
Push(CS);
Push(EIP);
GS ← 0; (* Segment registers made NULL, invalid for use in protected mode *)
FS ← 0;
DS ← 0;
ES ← 0;
CS ← Gate(CS); (* Segment descriptor information also loaded *)
CS(RPL) ← 0;
CPL ← 0;
IF IDT gate is 32-bit
    THEN
        EIP ← Gate(instruction pointer);
    ELSE (* IDT gate is 16-bit *)
        EIP ← Gate(instruction pointer) AND 0000FFFFH;
FI;
(* Start execution of new routine in Protected Mode *)
END;
INTRA-PRIVILEGE-LEVEL-INTERRUPT:
(* PE = 1, DPL = CPL or conforming segment *)
IF IA32_EFER.LMA = 1 (* IA-32e mode *)
    IF IDT-descriptor IST ≠ 0
        THEN
            TSSstackAddress ← (IDT-descriptor IST « 3) + 28;
            IF (TSSstackAddress + 7) > TSS limit
                THEN #TS(error_code(current TSS selector,0,EXT)); FI;
                (* idt operand to error_code is 0 because selector is used *)
                NewRSP ← 8 bytes loaded from (current TSS base + TSSstackAddress);
            ELSE NewRSP ← RSP;
        FI;
    FI;
IF 32-bit gate (* implies IA32_EFER.LMA = 0 *)

```

```

THEN
    IF current stack does not have room for 16 bytes (error code pushed)
    or 12 bytes (no error code pushed)
        THEN #SS(EXT); FI; (* Error code contains NULL selector *)
    ELSE IF 16-bit gate (* implies IA32_EFER.LMA = 0 *)
        IF current stack does not have room for 8 bytes (error code pushed)
        or 6 bytes (no error code pushed)
            THEN #SS(EXT); FI; (* Error code contains NULL selector *)
        ELSE (* IA32_EFER.LMA = 1, 64-bit gate*)
            IF NewRSP contains a non-canonical address
                THEN #SS(EXT); (* Error code contains NULL selector *)
        FI;
    FI;
FI;
IF (IA32_EFER.LMA = 0) (* Not IA-32e mode *)
    THEN
        IF instruction pointer from IDT gate is not within new code-segment limit
            THEN #GP(EXT); FI; (* Error code contains NULL selector *)
        ELSE
            IF instruction pointer from IDT gate contains a non-canonical address
                THEN #GP(EXT); FI; (* Error code contains NULL selector *)
            RSP ← NewRSP & FFFFFFFF0H;
        FI;
    FI;
IF IDT gate is 32-bit (* implies IA32_EFER.LMA = 0 *)
    THEN
        Push (EFLAGS);
        Push (far pointer to return instruction); (* 3 words padded to 4 *)
        CS:EIP ← Gate(CS:EIP); (* Segment descriptor information also loaded *)
        Push (ErrorCode); (* If any *)
    ELSE
        IF IDT gate is 16-bit (* implies IA32_EFER.LMA = 0 *)
            THEN
                Push (FLAGS);
                Push (far pointer to return location); (* 2 words *)
                CS:IP ← Gate(CS:IP);
                (* Segment descriptor information also loaded *)
                Push (ErrorCode); (* If any *)
            ELSE (* IA32_EFER.LMA = 1, 64-bit gate*)
                Push(far pointer to old stack);
                (* Old SS and SP, each an 8-byte push *)
                Push(RFLAGS); (* 8-byte push *)
                Push(far pointer to return instruction);
                (* Old CS and RIP, each an 8-byte push *)
                Push(ErrorCode); (* If needed, 8 bytes *)
                CS:RIP ← GATE(CS:RIP);
                (* Segment descriptor information also loaded *)
            FI;
        FI;
    FI;
FI;
CS(RPL) ← CPL;
IF IDT gate is interrupt gate
    THEN IF ← 0; FI; (* Interrupt flag set to 0; interrupts disabled *)
TF ← 0;
NT ← 0;
VM ← 0;
RF ← 0;

```

END;

### Flags Affected

The EFLAGS register is pushed onto the stack. The IF, TF, NT, AC, RF, and VM flags may be cleared, depending on the mode of operation of the processor when the INT instruction is executed (see the “Operation” section). If the interrupt uses a task gate, any flags may be set or cleared, controlled by the EFLAGS image in the new task’s TSS.

### Protected Mode Exceptions

#GP(error_code)	<p>If the instruction pointer in the IDT or in the interrupt-, trap-, or task gate is beyond the code segment limits.</p> <p>If the segment selector in the interrupt-, trap-, or task gate is NULL.</p> <p>If an interrupt-, trap-, or task gate, code segment, or TSS segment selector index is outside its descriptor table limits.</p> <p>If the vector selects a descriptor outside the IDT limits.</p> <p>If an IDT descriptor is not an interrupt-, trap-, or task-descriptor.</p> <p>If an interrupt is generated by the INT <i>n</i>, INT 3, or INTO instruction and the DPL of an interrupt-, trap-, or task-descriptor is less than the CPL.</p> <p>If the segment selector in an interrupt- or trap-gate does not point to a segment descriptor for a code segment.</p> <p>If the segment selector for a TSS has its local/global bit set for local.</p> <p>If a TSS segment descriptor specifies that the TSS is busy or not available.</p>
#SS(error_code)	<p>If pushing the return address, flags, or error code onto the stack exceeds the bounds of the stack segment and no stack switch occurs.</p> <p>If the SS register is being loaded and the segment pointed to is marked not present.</p> <p>If pushing the return address, flags, error code, or stack segment pointer exceeds the bounds of the new stack segment when a stack switch occurs.</p>
#NP(error_code)	If code segment, interrupt-, trap-, or task gate, or TSS is not present.
#TS(error_code)	<p>If the RPL of the stack segment selector in the TSS is not equal to the DPL of the code segment being accessed by the interrupt or trap gate.</p> <p>If DPL of the stack segment descriptor pointed to by the stack segment selector in the TSS is not equal to the DPL of the code segment descriptor for the interrupt or trap gate.</p> <p>If the stack segment selector in the TSS is NULL.</p> <p>If the stack segment for the TSS is not a writable data segment.</p> <p>If segment-selector index for stack segment is outside descriptor table limits.</p>
#PF(fault-code)	If a page fault occurs.
#UD	If the LOCK prefix is used.
#AC(EXT)	If alignment checking is enabled, the gate DPL is 3, and a stack push is unaligned.

### Real-Address Mode Exceptions

#GP	<p>If a memory operand effective address is outside the CS, DS, ES, FS, or GS segment limit.</p> <p>If the interrupt vector number is outside the IDT limits.</p>
#SS	<p>If stack limit violation on push.</p> <p>If pushing the return address, flags, or error code onto the stack exceeds the bounds of the stack segment.</p>
#UD	If the LOCK prefix is used.

## Virtual-8086 Mode Exceptions

#GP(error_code)	<p>(For INT <math>n</math>, INTO, or BOUND instruction) If the IOPL is less than 3 or the DPL of the interrupt-, trap-, or task-gate descriptor is not equal to 3.</p> <p>If the instruction pointer in the IDT or in the interrupt-, trap-, or task gate is beyond the code segment limits.</p> <p>If the segment selector in the interrupt-, trap-, or task gate is NULL.</p> <p>If a interrupt-, trap-, or task gate, code segment, or TSS segment selector index is outside its descriptor table limits.</p> <p>If the vector selects a descriptor outside the IDT limits.</p> <p>If an IDT descriptor is not an interrupt-, trap-, or task-descriptor.</p> <p>If an interrupt is generated by the INT <math>n</math> instruction and the DPL of an interrupt-, trap-, or task-descriptor is less than the CPL.</p> <p>If the segment selector in an interrupt- or trap-gate does not point to a segment descriptor for a code segment.</p> <p>If the segment selector for a TSS has its local/global bit set for local.</p>
#SS(error_code)	<p>If the SS register is being loaded and the segment pointed to is marked not present.</p> <p>If pushing the return address, flags, error code, stack segment pointer, or data segments exceeds the bounds of the stack segment.</p>
#NP(error_code)	If code segment, interrupt-, trap-, or task gate, or TSS is not present.
#TS(error_code)	<p>If the RPL of the stack segment selector in the TSS is not equal to the DPL of the code segment being accessed by the interrupt or trap gate.</p> <p>If DPL of the stack segment descriptor for the TSS's stack segment is not equal to the DPL of the code segment descriptor for the interrupt or trap gate.</p> <p>If the stack segment selector in the TSS is NULL.</p> <p>If the stack segment for the TSS is not a writable data segment.</p> <p>If segment-selector index for stack segment is outside descriptor table limits.</p>
#PF(fault-code)	If a page fault occurs.
#BP	If the INT 3 instruction is executed.
#OF	If the INTO instruction is executed and the OF flag is set.
#UD	If the LOCK prefix is used.
#AC(EXT)	If alignment checking is enabled, the gate DPL is 3, and a stack push is unaligned.

## Compatibility Mode Exceptions

Same exceptions as in protected mode.

**64-Bit Mode Exceptions**

#GP(error_code)	<p>If the instruction pointer in the 64-bit interrupt gate or 64-bit trap gate is non-canonical.</p> <p>If the segment selector in the 64-bit interrupt or trap gate is NULL.</p> <p>If the vector selects a descriptor outside the IDT limits.</p> <p>If the vector points to a gate which is in non-canonical space.</p> <p>If the vector points to a descriptor which is not a 64-bit interrupt gate or 64-bit trap gate.</p> <p>If the descriptor pointed to by the gate selector is outside the descriptor table limit.</p> <p>If the descriptor pointed to by the gate selector is in non-canonical space.</p> <p>If the descriptor pointed to by the gate selector is not a code segment.</p> <p>If the descriptor pointed to by the gate selector doesn't have the L-bit set, or has both the L-bit and D-bit set.</p> <p>If the descriptor pointed to by the gate selector has DPL &gt; CPL.</p>
#SS(error_code)	<p>If a push of the old EFLAGS, CS selector, EIP, or error code is in non-canonical space with no stack switch.</p> <p>If a push of the old SS selector, ESP, EFLAGS, CS selector, EIP, or error code is in non-canonical space on a stack switch (either CPL change or no-CPL with IST).</p>
#NP(error_code)	If the 64-bit interrupt-gate, 64-bit trap-gate, or code segment is not present.
#TS(error_code)	<p>If an attempt to load RSP from the TSS causes an access to non-canonical space.</p> <p>If the RSP from the TSS is outside descriptor table limits.</p>
#PF(fault-code)	If a page fault occurs.
#UD	If the LOCK prefix is used.
#AC(EXT)	If alignment checking is enabled, the gate DPL is 3, and a stack push is unaligned.

## INVD—Invalidate Internal Caches

Opcode	Instruction	Op/En	64-Bit Mode	Compat/Leg Mode	Description
0F 08	INVD	Z0	Valid	Valid	Flush internal caches; initiate flushing of external caches.

### NOTES:

\* See the IA-32 Architecture Compatibility section below.

### Instruction Operand Encoding

Op/En	Operand 1	Operand 2	Operand 3	Operand 4
Z0	NA	NA	NA	NA

### Description

Invalidates (flushes) the processor's internal caches and issues a special-function bus cycle that directs external caches to also flush themselves. Data held in internal caches is not written back to main memory.

After executing this instruction, the processor does not wait for the external caches to complete their flushing operation before proceeding with instruction execution. It is the responsibility of hardware to respond to the cache flush signal.

The INVD instruction is a privileged instruction. When the processor is running in protected mode, the CPL of a program or procedure must be 0 to execute this instruction.

The INVD instruction may be used when the cache is used as temporary memory and the cache contents need to be invalidated rather than written back to memory. When the cache is used as temporary memory, no external device should be actively writing data to main memory.

Use this instruction with care. Data cached internally and not written back to main memory will be lost. Note that any data from an external device to main memory (for example, via a PCIWrite) can be temporarily stored in the caches; these data can be lost when an INVD instruction is executed. Unless there is a specific requirement or benefit to flushing caches without writing back modified cache lines (for example, temporary memory, testing, or fault recovery where cache coherency with main memory is not a concern), software should instead use the WBINVD instruction.

This instruction's operation is the same in non-64-bit modes and 64-bit mode.

### IA-32 Architecture Compatibility

The INVD instruction is implementation dependent; it may be implemented differently on different families of Intel 64 or IA-32 processors. This instruction is not supported on IA-32 processors earlier than the Intel486 processor.

### Operation

Flush(InternalCaches);  
SignalFlush(ExternalCaches);  
Continue (\* Continue execution \*)

### Flags Affected

None

### Protected Mode Exceptions

#GP(0) If the current privilege level is not 0.  
#UD If the LOCK prefix is used.

### Real-Address Mode Exceptions

#UD If the LOCK prefix is used.

### Virtual-8086 Mode Exceptions

#GP(0)                    The INVD instruction cannot be executed in virtual-8086 mode.

### Compatibility Mode Exceptions

Same exceptions as in protected mode.

### 64-Bit Mode Exceptions

Same exceptions as in protected mode.



## INVLPG—Invalidate TLB Entries

Opcode	Instruction	Op/En	64-Bit Mode	Compat/Leg Mode	Description
OF 01/7	INVLPG <i>m</i>	M	Valid	Valid	Invalidate TLB entries for page containing <i>m</i> .

### NOTES:

\* See the IA-32 Architecture Compatibility section below.

### Instruction Operand Encoding

Op/En	Operand 1	Operand 2	Operand 3	Operand 4
M	ModRM:r/m ( <i>r</i> )	NA	NA	NA

### Description

Invalidates any translation lookaside buffer (TLB) entries specified with the source operand. The source operand is a memory address. The processor determines the page that contains that address and flushes all TLB entries for that page.<sup>1</sup>

The INVLPG instruction is a privileged instruction. When the processor is running in protected mode, the CPL must be 0 to execute this instruction.

The INVLPG instruction normally flushes TLB entries only for the specified page; however, in some cases, it may flush more entries, even the entire TLB. The instruction is guaranteed to invalidate only TLB entries associated with the current PCID. (If PCIDs are disabled — CR4.PCIDE = 0 — the current PCID is 000H.) The instruction also invalidates any global TLB entries for the specified page, regardless of PCID.

For more details on operations that flush the TLB, see “MOV—Move to/from Control Registers” in the *Intel® 64 and IA-32 Architectures Software Developer’s Manual, Volume 2B* and Section 4.10.4.1, “Operations that Invalidate TLBs and Paging-Structure Caches,” in the *Intel® 64 and IA-32 Architectures Software Developer’s Manual, Volume 3A*.

This instruction’s operation is the same in all non-64-bit modes. It also operates the same in 64-bit mode, except if the memory address is in non-canonical form. In this case, INVLPG is the same as a NOP.

### IA-32 Architecture Compatibility

The INVLPG instruction is implementation dependent, and its function may be implemented differently on different families of Intel 64 or IA-32 processors. This instruction is not supported on IA-32 processors earlier than the Intel486 processor.

### Operation

Invalidate(RelevantTLBEntries);  
Continue; (\* Continue execution \*)

### Flags Affected

None.

### Protected Mode Exceptions

#GP(0) If the current privilege level is not 0.  
#UD Operand is a register.  
If the LOCK prefix is used.

1. If the paging structures map the linear address using a page larger than 4 KBytes and there are multiple TLB entries for that page (see Section 4.10.2.3, “Details of TLB Use,” in the *Intel® 64 and IA-32 Architectures Software Developer’s Manual, Volume 3A*), the instruction invalidates all of them.

### Real-Address Mode Exceptions

#UD                    Operand is a register.  
                          If the LOCK prefix is used.

### Virtual-8086 Mode Exceptions

#GP(0)                The INVLPG instruction cannot be executed at the virtual-8086 mode.

### 64-Bit Mode Exceptions

#GP(0)                If the current privilege level is not 0.  
#UD                    Operand is a register.  
                          If the LOCK prefix is used.

## INVPCID—Invalidate Process-Context Identifier

Opcode/Instruction	Op/En	64/32-bit Mode	CPUID Feature Flag	Description
66 0F 38 82 /r INVPCID r32, m128	RM	NE/V	INVPCID	Invalidates entries in the TLBs and paging-structure caches based on invalidation type in r32 and descriptor in m128.
66 0F 38 82 /r INVPCID r64, m128	RM	V/NE	INVPCID	Invalidates entries in the TLBs and paging-structure caches based on invalidation type in r64 and descriptor in m128.

### Instruction Operand Encoding

Op/En	Operand 1	Operand 2	Operand 3	Operand 4
RM	ModRM:reg (R)	ModRM:r/m (R)	NA	NA

### Description

Invalidates mappings in the translation lookaside buffers (TLBs) and paging-structure caches based on process-context identifier (PCID). (See Section 4.10, “Caching Translation Information,” in *Intel 64 and IA-32 Architecture Software Developer’s Manual, Volume 3A*.) Invalidation is based on the INVPCID type specified in the register operand and the INVPCID descriptor specified in the memory operand.

Outside 64-bit mode, the register operand is always 32 bits, regardless of the value of CS.D. In 64-bit mode the register operand has 64 bits.

There are four INVPCID types currently defined:

- Individual-address invalidation: If the INVPCID type is 0, the logical processor invalidates mappings—except global translations—for the linear address and PCID specified in the INVPCID descriptor.<sup>1</sup> In some cases, the instruction may invalidate global translations or mappings for other linear addresses (or other PCIDs) as well.
- Single-context invalidation: If the INVPCID type is 1, the logical processor invalidates all mappings—except global translations—associated with the PCID specified in the INVPCID descriptor. In some cases, the instruction may invalidate global translations or mappings for other PCIDs as well.
- All-context invalidation, including global translations: If the INVPCID type is 2, the logical processor invalidates all mappings—including global translations—associated with any PCID.
- All-context invalidation: If the INVPCID type is 3, the logical processor invalidates all mappings—except global translations—associated with any PCID. In some case, the instruction may invalidate global translations as well.

The INVPCID descriptor comprises 128 bits and consists of a PCID and a linear address as shown in Figure 3-24. For INVPCID type 0, the processor uses the full 64 bits of the linear address even outside 64-bit mode; the linear address is not used for other INVPCID types.

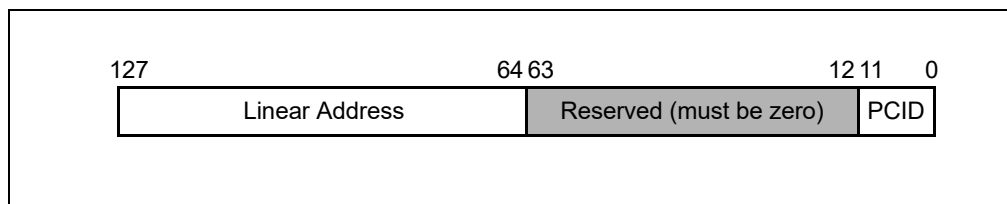

**Figure 3-24. INVPCID Descriptor**

1. If the paging structures map the linear address using a page larger than 4 KBytes and there are multiple TLB entries for that page (see Section 4.10.2.3, “Details of TLB Use,” in the *Intel® 64 and IA-32 Architectures Software Developer’s Manual, Volume 3A*), the instruction invalidates all of them.

If CR4.PCIDE = 0, a logical processor does not cache information for any PCID other than 000H. In this case, executions with INVPCID types 0 and 1 are allowed only if the PCID specified in the INVPCID descriptor is 000H; executions with INVPCID types 2 and 3 invalidate mappings only for PCID 000H. Note that CR4.PCIDE must be 0 outside 64-bit mode (see Chapter 4.10.1, “Process-Context Identifiers (PCIDs),” of the *Intel® 64 and IA-32 Architectures Software Developer’s Manual, Volume 3A*).

## Operation

```
INVPCID_TYPE ← value of register operand;      // must be in the range of 0-3
INVPCID_DESC ← value of memory operand;
CASE INVPCID_TYPE OF
  0:          // individual-address invalidation
    PCID ← INVPCID_DESC[11:0];
    L_ADDR ← INVPCID_DESC[127:64];
    Invalidate mappings for L_ADDR associated with PCID except global translations;
    BREAK;
  1:          // single PCID invalidation
    PCID ← INVPCID_DESC[11:0];
    Invalidate all mappings associated with PCID except global translations;
    BREAK;
  2:          // all PCID invalidation including global translations
    Invalidate all mappings for all PCIDs, including global translations;
    BREAK;
  3:          // all PCID invalidation retaining global translations
    Invalidate all mappings for all PCIDs except global translations;
    BREAK;
ESAC;
```

## Intel C/C++ Compiler Intrinsic Equivalent

```
INVPCID: void _invpcid(unsigned __int32 type, void * descriptor);
```

## SIMD Floating-Point Exceptions

None

## Protected Mode Exceptions

#GP(0)	<p>If the current privilege level is not 0.</p> <p>If the memory operand effective address is outside the CS, DS, ES, FS, or GS segment limit.</p> <p>If the DS, ES, FS, or GS register contains an unusable segment.</p> <p>If the source operand is located in an execute-only code segment.</p> <p>If an invalid type is specified in the register operand, i.e., INVPCID_TYPE &gt; 3.</p> <p>If bits 63:12 of INVPCID_DESC are not all zero.</p> <p>If INVPCID_TYPE is either 0 or 1 and INVPCID_DESC[11:0] is not zero.</p> <p>If INVPCID_TYPE is 0 and the linear address in INVPCID_DESC[127:64] is not canonical.</p>
#PF(fault-code)	If a page fault occurs in accessing the memory operand.
#SS(0)	<p>If the memory operand effective address is outside the SS segment limit.</p> <p>If the SS register contains an unusable segment.</p>
#UD	<p>If if CPUID.(EAX=07H, ECX=0H):EBX.INVPCID (bit 10) = 0.</p> <p>If the LOCK prefix is used.</p>

**Real-Address Mode Exceptions**

#GP	<p>If an invalid type is specified in the register operand, i.e., INVPCID_TYPE &gt; 3.</p> <p>If bits 63:12 of INVPCID_DESC are not all zero.</p> <p>If INVPCID_TYPE is either 0 or 1 and INVPCID_DESC[11:0] is not zero.</p> <p>If INVPCID_TYPE is 0 and the linear address in INVPCID_DESC[127:64] is not canonical.</p>
#UD	<p>If CPUID.(EAX=07H, ECX=0H):EBX.INVPCID (bit 10) = 0.</p> <p>If the LOCK prefix is used.</p>

**Virtual-8086 Mode Exceptions**

#GP(0)	The INVPCID instruction is not recognized in virtual-8086 mode.
--------	---

**Compatibility Mode Exceptions**

Same exceptions as in protected mode.

**64-Bit Mode Exceptions**

#GP(0)	<p>If the current privilege level is not 0.</p> <p>If the memory operand is in the CS, DS, ES, FS, or GS segments and the memory address is in a non-canonical form.</p> <p>If an invalid type is specified in the register operand, i.e., INVPCID_TYPE &gt; 3.</p> <p>If bits 63:12 of INVPCID_DESC are not all zero.</p> <p>If CR4.PCIDE=0, INVPCID_TYPE is either 0 or 1, and INVPCID_DESC[11:0] is not zero.</p> <p>If INVPCID_TYPE is 0 and the linear address in INVPCID_DESC[127:64] is not canonical.</p>
#PF(fault-code)	If a page fault occurs in accessing the memory operand.
#SS(0)	If the memory destination operand is in the SS segment and the memory address is in a non-canonical form.
#UD	<p>If the LOCK prefix is used.</p> <p>If CPUID.(EAX=07H, ECX=0H):EBX.INVPCID (bit 10) = 0.</p>

## IRET/IRETD—Interrupt Return

Opcode	Instruction	Op/En	64-Bit Mode	Compat/Leg Mode	Description
CF	IRET	Z0	Valid	Valid	Interrupt return (16-bit operand size).
CF	IRETD	Z0	Valid	Valid	Interrupt return (32-bit operand size).
REX.W + CF	IRETQ	Z0	Valid	N.E.	Interrupt return (64-bit operand size).

### Instruction Operand Encoding

Op/En	Operand 1	Operand 2	Operand 3	Operand 4
Z0	NA	NA	NA	NA

### Description

Returns program control from an exception or interrupt handler to a program or procedure that was interrupted by an exception, an external interrupt, or a software-generated interrupt. These instructions are also used to perform a return from a nested task. (A nested task is created when a CALL instruction is used to initiate a task switch or when an interrupt or exception causes a task switch to an interrupt or exception handler.) See the section titled “Task Linking” in Chapter 7 of the *Intel® 64 and IA-32 Architectures Software Developer’s Manual, Volume 3A*.

IRET and IRETD are mnemonics for the same opcode. The IRETD mnemonic (interrupt return double) is intended for use when returning from an interrupt when using the 32-bit operand size; however, most assemblers use the IRET mnemonic interchangeably for both operand sizes.

In Real-Address Mode, the IRET instruction preforms a far return to the interrupted program or procedure. During this operation, the processor pops the return instruction pointer, return code segment selector, and EFLAGS image from the stack to the EIP, CS, and EFLAGS registers, respectively, and then resumes execution of the interrupted program or procedure.

In Protected Mode, the action of the IRET instruction depends on the settings of the NT (nested task) and VM flags in the EFLAGS register and the VM flag in the EFLAGS image stored on the current stack. Depending on the setting of these flags, the processor performs the following types of interrupt returns:

- Return from virtual-8086 mode.
- Return to virtual-8086 mode.
- Intra-privilege level return.
- Inter-privilege level return.
- Return from nested task (task switch).

If the NT flag (EFLAGS register) is cleared, the IRET instruction performs a far return from the interrupt procedure, without a task switch. The code segment being returned to must be equally or less privileged than the interrupt handler routine (as indicated by the RPL field of the code segment selector popped from the stack).

As with a real-address mode interrupt return, the IRET instruction pops the return instruction pointer, return code segment selector, and EFLAGS image from the stack to the EIP, CS, and EFLAGS registers, respectively, and then resumes execution of the interrupted program or procedure. If the return is to another privilege level, the IRET instruction also pops the stack pointer and SS from the stack, before resuming program execution. If the return is to virtual-8086 mode, the processor also pops the data segment registers from the stack.

If the NT flag is set, the IRET instruction performs a task switch (return) from a nested task (a task called with a CALL instruction, an interrupt, or an exception) back to the calling or interrupted task. The updated state of the task executing the IRET instruction is saved in its TSS. If the task is re-entered later, the code that follows the IRET instruction is executed.

If the NT flag is set and the processor is in IA-32e mode, the IRET instruction causes a general protection exception.

If nonmaskable interrupts (NMIs) are blocked (see Section 6.7.1, “Handling Multiple NMIs” in the *Intel® 64 and IA-32 Architectures Software Developer’s Manual, Volume 3A*), execution of the IRET instruction unblocks NMIs.

This unblocking occurs even if the instruction causes a fault. In such a case, NMIs are unmasked before the exception handler is invoked.

In 64-bit mode, the instruction's default operation size is 32 bits. Use of the REX.W prefix promotes operation to 64 bits (IRETQ). See the summary chart at the beginning of this section for encoding data and limits.

See "Changes to Instruction Behavior in VMX Non-Root Operation" in Chapter 25 of the *Intel® 64 and IA-32 Architectures Software Developer's Manual, Volume 3C*, for more information about the behavior of this instruction in VMX non-root operation.

## Operation

```

IF PE = 0
    THEN GOTO REAL-ADDRESS-MODE;
ELSIF (IA32_EFER.LMA = 0)
    THEN
        IF (EFLAGS.VM = 1)
            THEN GOTO RETURN-FROM-VIRTUAL-8086-MODE;
            ELSE GOTO PROTECTED-MODE;
        FI;
    ELSE GOTO IA-32e-MODE;
FI;

REAL-ADDRESS-MODE:
    IF OperandSize = 32
        THEN
            EIP ← Pop();
            CS ← Pop(); (* 32-bit pop, high-order 16 bits discarded *)
            tempEFLAGS ← Pop();
            EFLAGS ← (tempEFLAGS AND 257FD5H) OR (EFLAGS AND 1A0000H);
        ELSE (* OperandSize = 16 *)
            EIP ← Pop(); (* 16-bit pop; clear upper 16 bits *)
            CS ← Pop(); (* 16-bit pop *)
            EFLAGS[15:0] ← Pop();
        FI;
    END;

RETURN-FROM-VIRTUAL-8086-MODE:
(* Processor is in virtual-8086 mode when IRET is executed and stays in virtual-8086 mode *)
    IF IOPL = 3 (* Virtual mode: PE = 1, VM = 1, IOPL = 3 *)
        THEN IF OperandSize = 32
            THEN
                EIP ← Pop();
                CS ← Pop(); (* 32-bit pop, high-order 16 bits discarded *)
                EFLAGS ← Pop();
                (* VM, IOPL, VIP and VIF EFLAG bits not modified by pop *)
                IF EIP not within CS limit
                    THEN #GP(0); FI;
            ELSE (* OperandSize = 16 *)
                EIP ← Pop(); (* 16-bit pop; clear upper 16 bits *)
                CS ← Pop(); (* 16-bit pop *)
                EFLAGS[15:0] ← Pop(); (* IOPL in EFLAGS not modified by pop *)
                IF EIP not within CS limit
                    THEN #GP(0); FI;
            FI;
        ELSE

```

## INSTRUCTION SET REFERENCE, A-L

```

        #GP(0); (* Trap to virtual-8086 monitor: PE = 1, VM = 1, IOPL < 3 *)
FI;
END;

PROTECTED-MODE:
  IF NT = 1
    THEN GOTO TASK-RETURN; (* PE = 1, VM = 0, NT = 1 *)
  FI;
  IF OperandSize = 32
    THEN
      EIP ← Pop();
      CS ← Pop(); (* 32-bit pop, high-order 16 bits discarded *)
      tempEFLAGS ← Pop();
    ELSE (* OperandSize = 16 *)
      EIP ← Pop(); (* 16-bit pop; clear upper bits *)
      CS ← Pop(); (* 16-bit pop *)
      tempEFLAGS ← Pop(); (* 16-bit pop; clear upper bits *)
    FI;
  IF tempEFLAGS(VM) = 1 and CPL = 0
    THEN GOTO RETURN-TO-VIRTUAL-8086-MODE;
  ELSE GOTO PROTECTED-MODE-RETURN;
  FI;

TASK-RETURN: (* PE = 1, VM = 0, NT = 1 *)
  SWITCH-TASKS (without nesting) to TSS specified in link field of current TSS;
  Mark the task just abandoned as NOT BUSY;
  IF EIP is not within CS limit
    THEN #GP(0); FI;
END;

RETURN-TO-VIRTUAL-8086-MODE:
  (* Interrupted procedure was in virtual-8086 mode: PE = 1, CPL=0, VM = 1 in flag image *)
  IF EIP not within CS limit
    THEN #GP(0); FI;
  EFLAGS ← tempEFLAGS;
  ESP ← Pop();
  SS ← Pop(); (* Pop 2 words; throw away high-order word *)
  ES ← Pop(); (* Pop 2 words; throw away high-order word *)
  DS ← Pop(); (* Pop 2 words; throw away high-order word *)
  FS ← Pop(); (* Pop 2 words; throw away high-order word *)
  GS ← Pop(); (* Pop 2 words; throw away high-order word *)
  CPL ← 3;
  (* Resume execution in Virtual-8086 mode *)
END;

PROTECTED-MODE-RETURN: (* PE = 1 *)
  IF CS(RPL) > CPL
    THEN GOTO RETURN-TO-OUTER-PRIVILEGE-LEVEL;
  ELSE GOTO RETURN-TO-SAME-PRIVILEGE-LEVEL; FI;
END;

RETURN-TO-OUTER-PRIVILEGE-LEVEL:
  IF OperandSize = 32
    THEN

```



```

    ESP ← Pop();
    SS ← Pop(); (* 32-bit pop, high-order 16 bits discarded *)
ELSE IF OperandSize = 16
    THEN
    ESP ← Pop(); (* 16-bit pop; clear upper bits *)
    SS ← Pop(); (* 16-bit pop *)
ELSE (* OperandSize = 64 *)
    RSP ← Pop();
    SS ← Pop(); (* 64-bit pop, high-order 48 bits discarded *)
FI;
IF new mode ≠ 64-Bit Mode
    THEN
    IF EIP is not within CS limit
        THEN #GP(0); FI;
    ELSE (* new mode = 64-bit mode *)
        IF RIP is non-canonical
            THEN #GP(0); FI;
FI;
EFLAGS (CF, PF, AF, ZF, SF, TF, DF, OF, NT) ← tempEFLAGS;
IF OperandSize = 32 or OperandSize = 64
    THEN EFLAGS(RF, AC, ID) ← tempEFLAGS; FI;
IF CPL ≤ IOPL
    THEN EFLAGS(IF) ← tempEFLAGS; FI;
IF CPL = 0
    THEN
    EFLAGS(IOPL) ← tempEFLAGS;
    IF OperandSize = 32 or OperandSize = 64
        THEN EFLAGS(VIF, VIP) ← tempEFLAGS; FI;
FI;
CPL ← CS(RPL);
FOR each SegReg in (ES, FS, GS, and DS)
    DO
    tempDesc ← descriptor cache for SegReg (* hidden part of segment register *)
    IF (SegmentSelector == NULL) OR (tempDesc(DPL) < CPL AND tempDesc(Type) is (data or non-conforming code)))
        THEN (* Segment register invalid *)
            SegmentSelector ← 0; (*Segment selector becomes null*)
    FI;
OD;
END;

RETURN-TO-SAME-PRIVILEGE-LEVEL: (* PE = 1, RPL = CPL *)
IF new mode ≠ 64-Bit Mode
    THEN
    IF EIP is not within CS limit
        THEN #GP(0); FI;
    ELSE (* new mode = 64-bit mode *)
        IF RIP is non-canonical
            THEN #GP(0); FI;
FI;
EFLAGS (CF, PF, AF, ZF, SF, TF, DF, OF, NT) ← tempEFLAGS;
IF OperandSize = 32 or OperandSize = 64
    THEN EFLAGS(RF, AC, ID) ← tempEFLAGS; FI;
IF CPL ≤ IOPL
    THEN EFLAGS(IF) ← tempEFLAGS; FI;

```

```

IF CPL = 0
  THEN
    EFLAGS(IOPL) ← tempEFLAGS;
    IF OperandSize = 32 or OperandSize = 64
      THEN EFLAGS(VIF, VIP) ← tempEFLAGS; FI;
  FI;
END;

IA-32e-MODE:
IF NT = 1
  THEN #GP(0);
ELSE IF OperandSize = 32
  THEN
    EIP ← Pop();
    CS ← Pop();
    tempEFLAGS ← Pop();
  ELSE IF OperandSize = 16
    THEN
      EIP ← Pop(); (* 16-bit pop; clear upper bits *)
      CS ← Pop(); (* 16-bit pop *)
      tempEFLAGS ← Pop(); (* 16-bit pop; clear upper bits *)
    FI;
  ELSE (* OperandSize = 64 *)
    THEN
      RIP ← Pop();
      CS ← Pop(); (* 64-bit pop, high-order 48 bits discarded *)
      tempRFLAGS ← Pop();
    FI;
  IF CS.RPL > CPL
    THEN GOTO RETURN-TO-OUTER-PRIVILEGE-LEVEL;
  ELSE
    IF instruction began in 64-Bit Mode
      THEN
        IF OperandSize = 32
          THEN
            ESP ← Pop();
            SS ← Pop(); (* 32-bit pop, high-order 16 bits discarded *)
          ELSE IF OperandSize = 16
            THEN
              ESP ← Pop(); (* 16-bit pop; clear upper bits *)
              SS ← Pop(); (* 16-bit pop *)
            ELSE (* OperandSize = 64 *)
              RSP ← Pop();
              SS ← Pop(); (* 64-bit pop, high-order 48 bits discarded *)
            FI;
          FI;
        GOTO RETURN-TO-SAME-PRIVILEGE-LEVEL; FI;
  END;

```

### Flags Affected

All the flags and fields in the EFLAGS register are potentially modified, depending on the mode of operation of the processor. If performing a return from a nested task to a previous task, the EFLAGS register will be modified according to the EFLAGS image stored in the previous task's TSS.

**Protected Mode Exceptions**

#GP(0)	If the return code or stack segment selector is NULL. If the return instruction pointer is not within the return code segment limit.
#GP(selector)	If a segment selector index is outside its descriptor table limits. If the return code segment selector RPL is less than the CPL. If the DPL of a conforming-code segment is greater than the return code segment selector RPL. If the DPL for a nonconforming-code segment is not equal to the RPL of the code segment selector. If the stack segment descriptor DPL is not equal to the RPL of the return code segment selector. If the stack segment is not a writable data segment. If the stack segment selector RPL is not equal to the RPL of the return code segment selector. If the segment descriptor for a code segment does not indicate it is a code segment. If the segment selector for a TSS has its local/global bit set for local. If a TSS segment descriptor specifies that the TSS is not busy. If a TSS segment descriptor specifies that the TSS is not available.
#SS(0)	If the top bytes of stack are not within stack limits. If the return stack segment is not present.
#NP (selector)	If the return code segment is not present.
#PF(fault-code)	If a page fault occurs.
#AC(0)	If an unaligned memory reference occurs when the CPL is 3 and alignment checking is enabled.
#UD	If the LOCK prefix is used.

**Real-Address Mode Exceptions**

#GP	If the return instruction pointer is not within the return code segment limit.
#SS	If the top bytes of stack are not within stack limits.

**Virtual-8086 Mode Exceptions**

#GP(0)	If the return instruction pointer is not within the return code segment limit. If IOPL not equal to 3.
#PF(fault-code)	If a page fault occurs.
#SS(0)	If the top bytes of stack are not within stack limits.
#AC(0)	If an unaligned memory reference occurs and alignment checking is enabled.
#UD	If the LOCK prefix is used.

**Compatibility Mode Exceptions**

#GP(0)	If EFLAGS.NT[bit 14] = 1.
Other exceptions same as in Protected Mode.	

**64-Bit Mode Exceptions**

#GP(0)	<p>If EFLAGS.NT[bit 14] = 1.</p> <p>If the return code segment selector is NULL.</p> <p>If the stack segment selector is NULL going back to compatibility mode.</p> <p>If the stack segment selector is NULL going back to CPL3 64-bit mode.</p> <p>If a NULL stack segment selector RPL is not equal to CPL going back to non-CPL3 64-bit mode.</p> <p>If the return instruction pointer is not within the return code segment limit.</p> <p>If the return instruction pointer is non-canonical.</p>
#GP(Selector)	<p>If a segment selector index is outside its descriptor table limits.</p> <p>If a segment descriptor memory address is non-canonical.</p> <p>If the segment descriptor for a code segment does not indicate it is a code segment.</p> <p>If the proposed new code segment descriptor has both the D-bit and L-bit set.</p> <p>If the DPL for a nonconforming-code segment is not equal to the RPL of the code segment selector.</p> <p>If CPL is greater than the RPL of the code segment selector.</p> <p>If the DPL of a conforming-code segment is greater than the return code segment selector RPL.</p> <p>If the stack segment is not a writable data segment.</p> <p>If the stack segment descriptor DPL is not equal to the RPL of the return code segment selector.</p> <p>If the stack segment selector RPL is not equal to the RPL of the return code segment selector.</p>
#SS(0)	<p>If an attempt to pop a value off the stack violates the SS limit.</p> <p>If an attempt to pop a value off the stack causes a non-canonical address to be referenced.</p> <p>If the return stack segment is not present.</p>
#NP (selector)	If the return code segment is not present.
#PF(fault-code)	If a page fault occurs.
#AC(0)	If an unaligned memory reference occurs when the CPL is 3 and alignment checking is enabled.
#UD	If the LOCK prefix is used.

## Jcc—Jump if Condition Is Met

Opcode	Instruction	Op/En	64-Bit Mode	Compat/Leg Mode	Description
77 <i>cb</i>	JA <i>rel8</i>	D	Valid	Valid	Jump short if above (CF=0 and ZF=0).
73 <i>cb</i>	JAE <i>rel8</i>	D	Valid	Valid	Jump short if above or equal (CF=0).
72 <i>cb</i>	JB <i>rel8</i>	D	Valid	Valid	Jump short if below (CF=1).
76 <i>cb</i>	JBE <i>rel8</i>	D	Valid	Valid	Jump short if below or equal (CF=1 or ZF=1).
72 <i>cb</i>	JC <i>rel8</i>	D	Valid	Valid	Jump short if carry (CF=1).
E3 <i>cb</i>	JCXZ <i>rel8</i>	D	N.E.	Valid	Jump short if CX register is 0.
E3 <i>cb</i>	JECXZ <i>rel8</i>	D	Valid	Valid	Jump short if ECX register is 0.
E3 <i>cb</i>	JRCXZ <i>rel8</i>	D	Valid	N.E.	Jump short if RCX register is 0.
74 <i>cb</i>	JE <i>rel8</i>	D	Valid	Valid	Jump short if equal (ZF=1).
7F <i>cb</i>	JG <i>rel8</i>	D	Valid	Valid	Jump short if greater (ZF=0 and SF=OF).
7D <i>cb</i>	JGE <i>rel8</i>	D	Valid	Valid	Jump short if greater or equal (SF=OF).
7C <i>cb</i>	JL <i>rel8</i>	D	Valid	Valid	Jump short if less (SF≠ OF).
7E <i>cb</i>	JLE <i>rel8</i>	D	Valid	Valid	Jump short if less or equal (ZF=1 or SF≠ OF).
76 <i>cb</i>	JNA <i>rel8</i>	D	Valid	Valid	Jump short if not above (CF=1 or ZF=1).
72 <i>cb</i>	JNAE <i>rel8</i>	D	Valid	Valid	Jump short if not above or equal (CF=1).
73 <i>cb</i>	JNB <i>rel8</i>	D	Valid	Valid	Jump short if not below (CF=0).
77 <i>cb</i>	JNBE <i>rel8</i>	D	Valid	Valid	Jump short if not below or equal (CF=0 and ZF=0).
73 <i>cb</i>	JNC <i>rel8</i>	D	Valid	Valid	Jump short if not carry (CF=0).
75 <i>cb</i>	JNE <i>rel8</i>	D	Valid	Valid	Jump short if not equal (ZF=0).
7E <i>cb</i>	JNG <i>rel8</i>	D	Valid	Valid	Jump short if not greater (ZF=1 or SF≠ OF).
7C <i>cb</i>	JNGE <i>rel8</i>	D	Valid	Valid	Jump short if not greater or equal (SF≠ OF).
7D <i>cb</i>	JNL <i>rel8</i>	D	Valid	Valid	Jump short if not less (SF=OF).
7F <i>cb</i>	JNLE <i>rel8</i>	D	Valid	Valid	Jump short if not less or equal (ZF=0 and SF=OF).
71 <i>cb</i>	JNO <i>rel8</i>	D	Valid	Valid	Jump short if not overflow (OF=0).
7B <i>cb</i>	JNP <i>rel8</i>	D	Valid	Valid	Jump short if not parity (PF=0).
79 <i>cb</i>	JNS <i>rel8</i>	D	Valid	Valid	Jump short if not sign (SF=0).
75 <i>cb</i>	JNZ <i>rel8</i>	D	Valid	Valid	Jump short if not zero (ZF=0).
70 <i>cb</i>	JO <i>rel8</i>	D	Valid	Valid	Jump short if overflow (OF=1).
7A <i>cb</i>	JP <i>rel8</i>	D	Valid	Valid	Jump short if parity (PF=1).
7A <i>cb</i>	JPE <i>rel8</i>	D	Valid	Valid	Jump short if parity even (PF=1).
7B <i>cb</i>	JPO <i>rel8</i>	D	Valid	Valid	Jump short if parity odd (PF=0).
78 <i>cb</i>	JS <i>rel8</i>	D	Valid	Valid	Jump short if sign (SF=1).
74 <i>cb</i>	JZ <i>rel8</i>	D	Valid	Valid	Jump short if zero (ZF = 1).
0F 87 <i>cw</i>	JA <i>rel16</i>	D	N.S.	Valid	Jump near if above (CF=0 and ZF=0). Not supported in 64-bit mode.
0F 87 <i>cd</i>	JA <i>rel32</i>	D	Valid	Valid	Jump near if above (CF=0 and ZF=0).
0F 83 <i>cw</i>	JAE <i>rel16</i>	D	N.S.	Valid	Jump near if above or equal (CF=0). Not supported in 64-bit mode.

Opcode	Instruction	Op/En	64-Bit Mode	Compat/Leg Mode	Description
0F 83 <i>cd</i>	JAE <i>rel32</i>	D	Valid	Valid	Jump near if above or equal (CF=0).
0F 82 <i>cw</i>	JB <i>rel16</i>	D	N.S.	Valid	Jump near if below (CF=1). Not supported in 64-bit mode.
0F 82 <i>cd</i>	JB <i>rel32</i>	D	Valid	Valid	Jump near if below (CF=1).
0F 86 <i>cw</i>	JBE <i>rel16</i>	D	N.S.	Valid	Jump near if below or equal (CF=1 or ZF=1). Not supported in 64-bit mode.
0F 86 <i>cd</i>	JBE <i>rel32</i>	D	Valid	Valid	Jump near if below or equal (CF=1 or ZF=1).
0F 82 <i>cw</i>	JC <i>rel16</i>	D	N.S.	Valid	Jump near if carry (CF=1). Not supported in 64-bit mode.
0F 82 <i>cd</i>	JC <i>rel32</i>	D	Valid	Valid	Jump near if carry (CF=1).
0F 84 <i>cw</i>	JE <i>rel16</i>	D	N.S.	Valid	Jump near if equal (ZF=1). Not supported in 64-bit mode.
0F 84 <i>cd</i>	JE <i>rel32</i>	D	Valid	Valid	Jump near if equal (ZF=1).
0F 84 <i>cw</i>	JZ <i>rel16</i>	D	N.S.	Valid	Jump near if 0 (ZF=1). Not supported in 64-bit mode.
0F 84 <i>cd</i>	JZ <i>rel32</i>	D	Valid	Valid	Jump near if 0 (ZF=1).
0F 8F <i>cw</i>	JG <i>rel16</i>	D	N.S.	Valid	Jump near if greater (ZF=0 and SF=OF). Not supported in 64-bit mode.
0F 8F <i>cd</i>	JG <i>rel32</i>	D	Valid	Valid	Jump near if greater (ZF=0 and SF=OF).
0F 8D <i>cw</i>	JGE <i>rel16</i>	D	N.S.	Valid	Jump near if greater or equal (SF=OF). Not supported in 64-bit mode.
0F 8D <i>cd</i>	JGE <i>rel32</i>	D	Valid	Valid	Jump near if greater or equal (SF=OF).
0F 8C <i>cw</i>	JL <i>rel16</i>	D	N.S.	Valid	Jump near if less (SF≠OF). Not supported in 64-bit mode.
0F 8C <i>cd</i>	JL <i>rel32</i>	D	Valid	Valid	Jump near if less (SF≠OF).
0F 8E <i>cw</i>	JLE <i>rel16</i>	D	N.S.	Valid	Jump near if less or equal (ZF=1 or SF≠OF). Not supported in 64-bit mode.
0F 8E <i>cd</i>	JLE <i>rel32</i>	D	Valid	Valid	Jump near if less or equal (ZF=1 or SF≠OF).
0F 86 <i>cw</i>	JNA <i>rel16</i>	D	N.S.	Valid	Jump near if not above (CF=1 or ZF=1). Not supported in 64-bit mode.
0F 86 <i>cd</i>	JNA <i>rel32</i>	D	Valid	Valid	Jump near if not above (CF=1 or ZF=1).
0F 82 <i>cw</i>	JNAE <i>rel16</i>	D	N.S.	Valid	Jump near if not above or equal (CF=1). Not supported in 64-bit mode.
0F 82 <i>cd</i>	JNAE <i>rel32</i>	D	Valid	Valid	Jump near if not above or equal (CF=1).
0F 83 <i>cw</i>	JNB <i>rel16</i>	D	N.S.	Valid	Jump near if not below (CF=0). Not supported in 64-bit mode.
0F 83 <i>cd</i>	JNB <i>rel32</i>	D	Valid	Valid	Jump near if not below (CF=0).
0F 87 <i>cw</i>	JNBE <i>rel16</i>	D	N.S.	Valid	Jump near if not below or equal (CF=0 and ZF=0). Not supported in 64-bit mode.
0F 87 <i>cd</i>	JNBE <i>rel32</i>	D	Valid	Valid	Jump near if not below or equal (CF=0 and ZF=0).
0F 83 <i>cw</i>	JNC <i>rel16</i>	D	N.S.	Valid	Jump near if not carry (CF=0). Not supported in 64-bit mode.
0F 83 <i>cd</i>	JNC <i>rel32</i>	D	Valid	Valid	Jump near if not carry (CF=0).

Opcode	Instruction	Op/ En	64-Bit Mode	Compat/ Leg Mode	Description
0F 85 <i>cw</i>	JNE <i>rel16</i>	D	N.S.	Valid	Jump near if not equal (ZF=0). Not supported in 64-bit mode.
0F 85 <i>cd</i>	JNE <i>rel32</i>	D	Valid	Valid	Jump near if not equal (ZF=0).
0F 8E <i>cw</i>	JNG <i>rel16</i>	D	N.S.	Valid	Jump near if not greater (ZF=1 or SF≠OF). Not supported in 64-bit mode.
0F 8E <i>cd</i>	JNG <i>rel32</i>	D	Valid	Valid	Jump near if not greater (ZF=1 or SF≠OF).
0F 8C <i>cw</i>	JNGE <i>rel16</i>	D	N.S.	Valid	Jump near if not greater or equal (SF≠OF). Not supported in 64-bit mode.
0F 8C <i>cd</i>	JNGE <i>rel32</i>	D	Valid	Valid	Jump near if not greater or equal (SF≠OF).
0F 8D <i>cw</i>	JNL <i>rel16</i>	D	N.S.	Valid	Jump near if not less (SF=OF). Not supported in 64-bit mode.
0F 8D <i>cd</i>	JNL <i>rel32</i>	D	Valid	Valid	Jump near if not less (SF=OF).
0F 8F <i>cw</i>	JNLE <i>rel16</i>	D	N.S.	Valid	Jump near if not less or equal (ZF=0 and SF=OF). Not supported in 64-bit mode.
0F 8F <i>cd</i>	JNLE <i>rel32</i>	D	Valid	Valid	Jump near if not less or equal (ZF=0 and SF=OF).
0F 81 <i>cw</i>	JNO <i>rel16</i>	D	N.S.	Valid	Jump near if not overflow (OF=0). Not supported in 64-bit mode.
0F 81 <i>cd</i>	JNO <i>rel32</i>	D	Valid	Valid	Jump near if not overflow (OF=0).
0F 8B <i>cw</i>	JNP <i>rel16</i>	D	N.S.	Valid	Jump near if not parity (PF=0). Not supported in 64-bit mode.
0F 8B <i>cd</i>	JNP <i>rel32</i>	D	Valid	Valid	Jump near if not parity (PF=0).
0F 89 <i>cw</i>	JNS <i>rel16</i>	D	N.S.	Valid	Jump near if not sign (SF=0). Not supported in 64-bit mode.
0F 89 <i>cd</i>	JNS <i>rel32</i>	D	Valid	Valid	Jump near if not sign (SF=0).
0F 85 <i>cw</i>	JNZ <i>rel16</i>	D	N.S.	Valid	Jump near if not zero (ZF=0). Not supported in 64-bit mode.
0F 85 <i>cd</i>	JNZ <i>rel32</i>	D	Valid	Valid	Jump near if not zero (ZF=0).
0F 80 <i>cw</i>	JO <i>rel16</i>	D	N.S.	Valid	Jump near if overflow (OF=1). Not supported in 64-bit mode.
0F 80 <i>cd</i>	JO <i>rel32</i>	D	Valid	Valid	Jump near if overflow (OF=1).
0F 8A <i>cw</i>	JP <i>rel16</i>	D	N.S.	Valid	Jump near if parity (PF=1). Not supported in 64-bit mode.
0F 8A <i>cd</i>	JP <i>rel32</i>	D	Valid	Valid	Jump near if parity (PF=1).
0F 8A <i>cw</i>	JPE <i>rel16</i>	D	N.S.	Valid	Jump near if parity even (PF=1). Not supported in 64-bit mode.
0F 8A <i>cd</i>	JPE <i>rel32</i>	D	Valid	Valid	Jump near if parity even (PF=1).
0F 8B <i>cw</i>	JPO <i>rel16</i>	D	N.S.	Valid	Jump near if parity odd (PF=0). Not supported in 64-bit mode.
0F 8B <i>cd</i>	JPO <i>rel32</i>	D	Valid	Valid	Jump near if parity odd (PF=0).
0F 88 <i>cw</i>	JS <i>rel16</i>	D	N.S.	Valid	Jump near if sign (SF=1). Not supported in 64-bit mode.

Opcode	Instruction	Op/En	64-Bit Mode	Compat/Leg Mode	Description
0F 88 <i>cd</i>	J <sub>S</sub> <i>rel32</i>	D	Valid	Valid	Jump near if sign (SF=1).
0F 84 <i>cw</i>	J <sub>Z</sub> <i>rel16</i>	D	N.S.	Valid	Jump near if 0 (ZF=1). Not supported in 64-bit mode.
0F 84 <i>cd</i>	J <sub>Z</sub> <i>rel32</i>	D	Valid	Valid	Jump near if 0 (ZF=1).

### Instruction Operand Encoding

Op/En	Operand 1	Operand 2	Operand 3	Operand 4
D	Offset	NA	NA	NA

### Description

Checks the state of one or more of the status flags in the EFLAGS register (CF, OF, PF, SF, and ZF) and, if the flags are in the specified state (condition), performs a jump to the target instruction specified by the destination operand. A condition code (*cc*) is associated with each instruction to indicate the condition being tested for. If the condition is not satisfied, the jump is not performed and execution continues with the instruction following the *Jcc* instruction.

The target instruction is specified with a relative offset (a signed offset relative to the current value of the instruction pointer in the EIP register). A relative offset (*rel8*, *rel16*, or *rel32*) is generally specified as a label in assembly code, but at the machine code level, it is encoded as a signed, 8-bit or 32-bit immediate value, which is added to the instruction pointer. Instruction coding is most efficient for offsets of -128 to +127. If the operand-size attribute is 16, the upper two bytes of the EIP register are cleared, resulting in a maximum instruction pointer size of 16 bits.

The conditions for each *Jcc* mnemonic are given in the "Description" column of the table on the preceding page. The terms "less" and "greater" are used for comparisons of signed integers and the terms "above" and "below" are used for unsigned integers.

Because a particular state of the status flags can sometimes be interpreted in two ways, two mnemonics are defined for some opcodes. For example, the JA (jump if above) instruction and the JNBE (jump if not below or equal) instruction are alternate mnemonics for the opcode 77H.

The *Jcc* instruction does not support far jumps (jumps to other code segments). When the target for the conditional jump is in a different segment, use the opposite condition from the condition being tested for the *Jcc* instruction, and then access the target with an unconditional far jump (JMP instruction) to the other segment. For example, the following conditional far jump is illegal:

```
JZ FARLABEL;
```

To accomplish this far jump, use the following two instructions:

```
JNZ BEYOND;
JMP FARLABEL;
BEYOND:
```

The JRCXZ, JECXZ and JCXZ instructions differ from other *Jcc* instructions because they do not check status flags. Instead, they check RCX, ECX or CX for 0. The register checked is determined by the address-size attribute. These instructions are useful when used at the beginning of a loop that terminates with a conditional loop instruction (such as LOOPNE). They can be used to prevent an instruction sequence from entering a loop when RCX, ECX or CX is 0. This would cause the loop to execute  $2^{64}$ ,  $2^{32}$  or 64K times (not zero times).

All conditional jumps are converted to code fetches of one or two cache lines, regardless of jump address or cacheability.

In 64-bit mode, operand size is fixed at 64 bits. JMP Short is RIP = RIP + 8-bit offset sign extended to 64 bits. JMP Near is RIP = RIP + 32-bit offset sign extended to 64 bits.



## Operation

```

IF condition
  THEN
    tempEIP ← EIP + SignExtend(DEST);
    IF OperandSize = 16
      THEN tempEIP ← tempEIP AND 0000FFFFH;
    FI;
  IF tempEIP is not within code segment limit
    THEN #GP(0);
    ELSE EIP ← tempEIP
  FI;
FI;

```

## Flags Affected

None

## Protected Mode Exceptions

#GP(0) If the offset being jumped to is beyond the limits of the CS segment.  
 #UD If the LOCK prefix is used.

## Real-Address Mode Exceptions

#GP If the offset being jumped to is beyond the limits of the CS segment or is outside of the effective address space from 0 to FFFFH. This condition can occur if a 32-bit address size override prefix is used.  
 #UD If the LOCK prefix is used.

## Virtual-8086 Mode Exceptions

Same exceptions as in real address mode.

## Compatibility Mode Exceptions

Same exceptions as in protected mode.

## 64-Bit Mode Exceptions

#GP(0) If the memory address is in a non-canonical form.  
 #UD If the LOCK prefix is used.

**JMP—Jump**

Opcode	Instruction	Op/En	64-Bit Mode	Compat/Leg Mode	Description
EB <i>cb</i>	JMP <i>rel8</i>	D	Valid	Valid	Jump short, RIP = RIP + 8-bit displacement sign extended to 64-bits
E9 <i>cw</i>	JMP <i>rel16</i>	D	N.S.	Valid	Jump near, relative, displacement relative to next instruction. Not supported in 64-bit mode.
E9 <i>cd</i>	JMP <i>rel32</i>	D	Valid	Valid	Jump near, relative, RIP = RIP + 32-bit displacement sign extended to 64-bits
FF <i>/4</i>	JMP <i>r/m16</i>	M	N.S.	Valid	Jump near, absolute indirect, address = zero-extended <i>r/m16</i> . Not supported in 64-bit mode.
FF <i>/4</i>	JMP <i>r/m32</i>	M	N.S.	Valid	Jump near, absolute indirect, address given in <i>r/m32</i> . Not supported in 64-bit mode.
FF <i>/4</i>	JMP <i>r/m64</i>	M	Valid	N.E.	Jump near, absolute indirect, RIP = 64-bit offset from register or memory
EA <i>cd</i>	JMP <i>ptr16:16</i>	D	Inv.	Valid	Jump far, absolute, address given in operand
EA <i>cp</i>	JMP <i>ptr16:32</i>	D	Inv.	Valid	Jump far, absolute, address given in operand
FF <i>/5</i>	JMP <i>m16:16</i>	D	Valid	Valid	Jump far, absolute indirect, address given in <i>m16:16</i>
FF <i>/5</i>	JMP <i>m16:32</i>	D	Valid	Valid	Jump far, absolute indirect, address given in <i>m16:32</i> .
REX.W + FF <i>/5</i>	JMP <i>m16:64</i>	D	Valid	N.E.	Jump far, absolute indirect, address given in <i>m16:64</i> .

**Instruction Operand Encoding**

Op/En	Operand 1	Operand 2	Operand 3	Operand 4
D	Offset	NA	NA	NA
M	ModRM:r/m ( <i>r</i> )	NA	NA	NA

**Description**

Transfers program control to a different point in the instruction stream without recording return information. The destination (target) operand specifies the address of the instruction being jumped to. This operand can be an immediate value, a general-purpose register, or a memory location.

This instruction can be used to execute four different types of jumps:

- Near jump—A jump to an instruction within the current code segment (the segment currently pointed to by the CS register), sometimes referred to as an intrasegment jump.
- Short jump—A near jump where the jump range is limited to -128 to +127 from the current EIP value.
- Far jump—A jump to an instruction located in a different segment than the current code segment but at the same privilege level, sometimes referred to as an intersegment jump.
- Task switch—A jump to an instruction located in a different task.

A task switch can only be executed in protected mode (see Chapter 7, in the *Intel® 64 and IA-32 Architectures Software Developer's Manual, Volume 3A*, for information on performing task switches with the JMP instruction).

**Near and Short Jumps.** When executing a near jump, the processor jumps to the address (within the current code segment) that is specified with the target operand. The target operand specifies either an absolute offset (that is an offset from the base of the code segment) or a relative offset (a signed displacement relative to the current

value of the instruction pointer in the EIP register). A near jump to a relative offset of 8-bits (*rel8*) is referred to as a short jump. The CS register is not changed on near and short jumps.

An absolute offset is specified indirectly in a general-purpose register or a memory location (*r/m16* or *r/m32*). The operand-size attribute determines the size of the target operand (16 or 32 bits). Absolute offsets are loaded directly into the EIP register. If the operand-size attribute is 16, the upper two bytes of the EIP register are cleared, resulting in a maximum instruction pointer size of 16 bits.

A relative offset (*rel8*, *rel16*, or *rel32*) is generally specified as a label in assembly code, but at the machine code level, it is encoded as a signed 8-, 16-, or 32-bit immediate value. This value is added to the value in the EIP register. (Here, the EIP register contains the address of the instruction following the JMP instruction). When using relative offsets, the opcode (for short vs. near jumps) and the operand-size attribute (for near relative jumps) determines the size of the target operand (8, 16, or 32 bits).

**Far Jumps in Real-Address or Virtual-8086 Mode.** When executing a far jump in real-address or virtual-8086 mode, the processor jumps to the code segment and offset specified with the target operand. Here the target operand specifies an absolute far address either directly with a pointer (*ptr16:16* or *ptr16:32*) or indirectly with a memory location (*m16:16* or *m16:32*). With the pointer method, the segment and address of the called procedure is encoded in the instruction, using a 4-byte (16-bit operand size) or 6-byte (32-bit operand size) far address immediate. With the indirect method, the target operand specifies a memory location that contains a 4-byte (16-bit operand size) or 6-byte (32-bit operand size) far address. The far address is loaded directly into the CS and EIP registers. If the operand-size attribute is 16, the upper two bytes of the EIP register are cleared.

**Far Jumps in Protected Mode.** When the processor is operating in protected mode, the JMP instruction can be used to perform the following three types of far jumps:

- A far jump to a conforming or non-conforming code segment.
- A far jump through a call gate.
- A task switch.

(The JMP instruction cannot be used to perform inter-privilege-level far jumps.)

In protected mode, the processor always uses the segment selector part of the far address to access the corresponding descriptor in the GDT or LDT. The descriptor type (code segment, call gate, task gate, or TSS) and access rights determine the type of jump to be performed.

If the selected descriptor is for a code segment, a far jump to a code segment at the same privilege level is performed. (If the selected code segment is at a different privilege level and the code segment is non-conforming, a general-protection exception is generated.) A far jump to the same privilege level in protected mode is very similar to one carried out in real-address or virtual-8086 mode. The target operand specifies an absolute far address either directly with a pointer (*ptr16:16* or *ptr16:32*) or indirectly with a memory location (*m16:16* or *m16:32*). The operand-size attribute determines the size of the offset (16 or 32 bits) in the far address. The new code segment selector and its descriptor are loaded into CS register, and the offset from the instruction is loaded into the EIP register. Note that a call gate (described in the next paragraph) can also be used to perform far call to a code segment at the same privilege level. Using this mechanism provides an extra level of indirection and is the preferred method of making jumps between 16-bit and 32-bit code segments.

When executing a far jump through a call gate, the segment selector specified by the target operand identifies the call gate. (The offset part of the target operand is ignored.) The processor then jumps to the code segment specified in the call gate descriptor and begins executing the instruction at the offset specified in the call gate. No stack switch occurs. Here again, the target operand can specify the far address of the call gate either directly with a pointer (*ptr16:16* or *ptr16:32*) or indirectly with a memory location (*m16:16* or *m16:32*).

Executing a task switch with the JMP instruction is somewhat similar to executing a jump through a call gate. Here the target operand specifies the segment selector of the task gate for the task being switched to (and the offset part of the target operand is ignored). The task gate in turn points to the TSS for the task, which contains the segment selectors for the task's code and stack segments. The TSS also contains the EIP value for the next instruction that was to be executed before the task was suspended. This instruction pointer value is loaded into the EIP register so that the task begins executing again at this next instruction.

The JMP instruction can also specify the segment selector of the TSS directly, which eliminates the indirection of the task gate. See Chapter 7 in *Intel® 64 and IA-32 Architectures Software Developer's Manual, Volume 3A*, for detailed information on the mechanics of a task switch.

Note that when you execute at task switch with a JMP instruction, the nested task flag (NT) is not set in the EFLAGS register and the new TSS's previous task link field is not loaded with the old task's TSS selector. A return to the previous task can thus not be carried out by executing the IRET instruction. Switching tasks with the JMP instruction differs in this regard from the CALL instruction which does set the NT flag and save the previous task link information, allowing a return to the calling task with an IRET instruction.

**In 64-Bit Mode** — The instruction's operation size is fixed at 64 bits. If a selector points to a gate, then RIP equals the 64-bit displacement taken from gate; else RIP equals the zero-extended offset from the far pointer referenced in the instruction.

See the summary chart at the beginning of this section for encoding data and limits.

## Operation

```

IF near jump
  IF 64-bit Mode
    THEN
      IF near relative jump
        THEN
          tempRIP ← RIP + DEST; (* RIP is instruction following JMP instruction*)
        ELSE (* Near absolute jump *)
          tempRIP ← DEST;
        FI;
      ELSE
        IF near relative jump
          THEN
            tempEIP ← EIP + DEST; (* EIP is instruction following JMP instruction*)
          ELSE (* Near absolute jump *)
            tempEIP ← DEST;
          FI;
        FI;
      IF (IA32_EFER.LMA = 0 or target mode = Compatibility mode)
        and tempEIP outside code segment limit
          THEN #GP(0); FI
      IF 64-bit mode and tempRIP is not canonical
          THEN #GP(0);
      FI;
      IF OperandSize = 32
        THEN
          EIP ← tempEIP;
        ELSE
          IF OperandSize = 16
            THEN (* OperandSize = 16 *)
              EIP ← tempEIP AND 0000FFFFH;
            ELSE (* OperandSize = 64 *)
              RIP ← tempRIP;
            FI;
          FI;
        FI;
      IF far jump and (PE = 0 or (PE = 1 AND VM = 1)) (* Real-address or virtual-8086 mode *)
        THEN
          tempEIP ← DEST(Offset); (* DEST is ptr16:32 or [m16:32] *)
          IF tempEIP is beyond code segment limit
            THEN #GP(0); FI;
          CS ← DEST(segment selector); (* DEST is ptr16:32 or [m16:32] *)
          IF OperandSize = 32
  
```

```

    THEN
        EIP ← tempEIP; (* DEST is ptr16:32 or [m16:32] *)
    ELSE (* OperandSize = 16 *)
        EIP ← tempEIP AND 0000FFFFH; (* Clear upper 16 bits *)
    FI;
FI;
IF far jump and (PE = 1 and VM = 0)
(* IA-32e mode or protected mode, not virtual-8086 mode *)
    THEN
        IF effective address in the CS, DS, ES, FS, GS, or SS segment is illegal
        or segment selector in target operand NULL
            THEN #GP(0); FI;
        IF segment selector index not within descriptor table limits
            THEN #GP(new selector); FI;
        Read type and access rights of segment descriptor;
        IF (EFER.LMA = 0)
            THEN
                IF segment type is not a conforming or nonconforming code
                segment, call gate, task gate, or TSS
                    THEN #GP(segment selector); FI;
            ELSE
                IF segment type is not a conforming or nonconforming code segment
                call gate
                    THEN #GP(segment selector); FI;
            FI;
        Depending on type and access rights:
            GO TO CONFORMING-CODE-SEGMENT;
            GO TO NONCONFORMING-CODE-SEGMENT;
            GO TO CALL-GATE;
            GO TO TASK-GATE;
            GO TO TASK-STATE-SEGMENT;
        ELSE
            #GP(segment selector);
    FI;
CONFORMING-CODE-SEGMENT:
    IF L-Bit = 1 and D-BIT = 1 and IA32_EFER.LMA = 1
        THEN GP(new code segment selector); FI;
    IF DPL > CPL
        THEN #GP(segment selector); FI;
    IF segment not present
        THEN #NP(segment selector); FI;
    tempEIP ← DEST(Offset);
    IF OperandSize = 16
        THEN tempEIP ← tempEIP AND 0000FFFFH;
    FI;
    IF (IA32_EFER.LMA = 0 or target mode = Compatibility mode) and
    tempEIP outside code segment limit
        THEN #GP(0); FI
    IF tempEIP is non-canonical
        THEN #GP(0); FI;
    CS ← DEST[segment selector]; (* Segment descriptor information also loaded *)
    CS(RPL) ← CPL
    EIP ← tempEIP;
END;

```

## NONCONFORMING-CODE-SEGMENT:

```

IF L-Bit = 1 and D-BIT = 1 and IA32_EFER.LMA = 1
    THEN GP(new code segment selector); FI;
IF (RPL > CPL) OR (DPL ≠ CPL)
    THEN #GP(code segment selector); FI;
IF segment not present
    THEN #NP(segment selector); FI;
tempEIP ← DEST(Offset);
IF OperandSize = 16
    THEN tempEIP ← tempEIP AND 0000FFFFH; FI;
IF (IA32_EFER.LMA = 0 OR target mode = Compatibility mode)
and tempEIP outside code segment limit
    THEN #GP(0); FI;
IF tempEIP is non-canonical THEN #GP(0); FI;
CS ← DEST[segment selector]; (* Segment descriptor information also loaded *)
CS(RPL) ← CPL;
EIP ← tempEIP;
END;

```

## CALL-GATE:

```

IF call gate DPL < CPL
or call gate DPL < call gate segment-selector RPL
    THEN #GP(call gate selector); FI;
IF call gate not present
    THEN #NP(call gate selector); FI;
IF call gate code-segment selector is NULL
    THEN #GP(0); FI;
IF call gate code-segment selector index outside descriptor table limits
    THEN #GP(code segment selector); FI;
Read code segment descriptor;
IF code-segment segment descriptor does not indicate a code segment
or code-segment segment descriptor is conforming and DPL > CPL
or code-segment segment descriptor is non-conforming and DPL ≠ CPL
    THEN #GP(code segment selector); FI;
IF IA32_EFER.LMA = 1 and (code-segment descriptor is not a 64-bit code segment
or code-segment segment descriptor has both L-Bit and D-bit set)
    THEN #GP(code segment selector); FI;
IF code segment is not present
    THEN #NP(code-segment selector); FI;
tempEIP ← DEST(Offset);
IF GateSize = 16
    THEN tempEIP ← tempEIP AND 0000FFFFH; FI;
IF (IA32_EFER.LMA = 0 OR target mode = Compatibility mode) AND tempEIP
outside code segment limit
    THEN #GP(0); FI;
CS ← DEST[SegmentSelector]; (* Segment descriptor information also loaded *)
CS(RPL) ← CPL;
EIP ← tempEIP;
END;

```

## TASK-GATE:

```

IF task gate DPL < CPL
or task gate DPL < task gate segment-selector RPL
    THEN #GP(task gate selector); FI;
IF task gate not present

```

```

    THEN #NP(gate selector); FI;
Read the TSS segment selector in the task-gate descriptor;
IF TSS segment selector local/global bit is set to local
or index not within GDT limits
or descriptor is not a TSS segment
or descriptor specifies that the TSS is busy
    THEN #GP(TSS selector); FI;
IF TSS not present
    THEN #NP(TSS selector); FI;
SWITCH-TASKS to TSS;
IF EIP not within code segment limit
    THEN #GP(0); FI;
END;
TASK-STATE-SEGMENT:
    IF TSS DPL < CPL
    or TSS DPL < TSS segment-selector RPL
    or TSS descriptor indicates TSS not available
        THEN #GP(TSS selector); FI;
    IF TSS is not present
        THEN #NP(TSS selector); FI;
    SWITCH-TASKS to TSS;
    IF EIP not within code segment limit
        THEN #GP(0); FI;
END;

```

### Flags Affected

All flags are affected if a task switch occurs; no flags are affected if a task switch does not occur.

### Protected Mode Exceptions

#GP(0)	<p>If offset in target operand, call gate, or TSS is beyond the code segment limits.</p> <p>If the segment selector in the destination operand, call gate, task gate, or TSS is NULL.</p> <p>If a memory operand effective address is outside the CS, DS, ES, FS, or GS segment limit.</p> <p>If the DS, ES, FS, or GS register is used to access memory and it contains a NULL segment selector.</p>
#GP(selector)	<p>If the segment selector index is outside descriptor table limits.</p> <p>If the segment descriptor pointed to by the segment selector in the destination operand is not for a conforming-code segment, nonconforming-code segment, call gate, task gate, or task state segment.</p> <p>If the DPL for a nonconforming-code segment is not equal to the CPL (When not using a call gate.) If the RPL for the segment's segment selector is greater than the CPL.</p> <p>If the DPL for a conforming-code segment is greater than the CPL.</p> <p>If the DPL from a call-gate, task-gate, or TSS segment descriptor is less than the CPL or than the RPL of the call-gate, task-gate, or TSS's segment selector.</p> <p>If the segment descriptor for selector in a call gate does not indicate it is a code segment.</p> <p>If the segment descriptor for the segment selector in a task gate does not indicate an available TSS.</p> <p>If the segment selector for a TSS has its local/global bit set for local.</p> <p>If a TSS segment descriptor specifies that the TSS is busy or not available.</p>
#SS(0)	<p>If a memory operand effective address is outside the SS segment limit.</p>

#NP (selector)	If the code segment being accessed is not present. If call gate, task gate, or TSS not present.
#PF(fault-code)	If a page fault occurs.
#AC(0)	If alignment checking is enabled and an unaligned memory reference is made while the current privilege level is 3. (Only occurs when fetching target from memory.)
#UD	If the LOCK prefix is used.

### Real-Address Mode Exceptions

#GP	If a memory operand effective address is outside the CS, DS, ES, FS, or GS segment limit. If a memory operand effective address is outside the CS, DS, ES, FS, or GS segment limit.
#SS	If a memory operand effective address is outside the SS segment limit.
#UD	If the LOCK prefix is used.

### Virtual-8086 Mode Exceptions

#GP(0)	If the target operand is beyond the code segment limits. If a memory operand effective address is outside the CS, DS, ES, FS, or GS segment limit.
#SS(0)	If a memory operand effective address is outside the SS segment limit.
#PF(fault-code)	If a page fault occurs.
#AC(0)	If alignment checking is enabled and an unaligned memory reference is made. (Only occurs when fetching target from memory.)
#UD	If the LOCK prefix is used.

### Compatibility Mode Exceptions

Same as 64-bit mode exceptions.

### 64-Bit Mode Exceptions

#GP(0)	If a memory address is non-canonical. If target offset in destination operand is non-canonical. If target offset in destination operand is beyond the new code segment limit. If the segment selector in the destination operand is NULL. If the code segment selector in the 64-bit gate is NULL.
#GP(selector)	If the code segment or 64-bit call gate is outside descriptor table limits. If the code segment or 64-bit call gate overlaps non-canonical space. If the segment descriptor from a 64-bit call gate is in non-canonical space. If the segment descriptor pointed to by the segment selector in the destination operand is not for a conforming-code segment, nonconforming-code segment, 64-bit call gate. If the segment descriptor pointed to by the segment selector in the destination operand is a code segment, and has both the D-bit and the L-bit set. If the DPL for a nonconforming-code segment is not equal to the CPL, or the RPL for the segment's segment selector is greater than the CPL. If the DPL for a conforming-code segment is greater than the CPL. If the DPL from a 64-bit call-gate is less than the CPL or than the RPL of the 64-bit call-gate. If the upper type field of a 64-bit call gate is not 0x0. If the segment selector from a 64-bit call gate is beyond the descriptor table limits. If the code segment descriptor pointed to by the selector in the 64-bit gate doesn't have the L-bit set and the D-bit clear. If the segment descriptor for a segment selector from the 64-bit call gate does not indicate it is a code segment. If the code segment is non-conforming and $CPL \neq DPL$ .



#NP(selector)	If the code segment is confirming and $CPL < DPL$ .
#UD	If a code segment or 64-bit call gate is not present. (64-bit mode only) If a far jump is direct to an absolute address in memory.
#PF(fault-code)	If the LOCK prefix is used.
#AC(0)	If a page fault occurs.
	If alignment checking is enabled and an unaligned memory reference is made while the current privilege level is 3.

**KADDW/KADDB/KADDQ/KADD—ADD Two Masks**

Opcode/ Instruction	Op/En	64/32 bit Mode Support	CPUID Feature Flag	Description
VEX.L1.0F.W0 4A /r KADDW k1, k2, k3	RVR	V/V	AVX512DQ	Add 16 bits masks in k2 and k3 and place result in k1.
VEX.L1.66.0F.W0 4A /r KADDB k1, k2, k3	RVR	V/V	AVX512DQ	Add 8 bits masks in k2 and k3 and place result in k1.
VEX.L1.0F.W1 4A /r KADDQ k1, k2, k3	RVR	V/V	AVX512BW	Add 64 bits masks in k2 and k3 and place result in k1.
VEX.L1.66.0F.W1 4A /r KADD k1, k2, k3	RVR	V/V	AVX512BW	Add 32 bits masks in k2 and k3 and place result in k1.

**Instruction Operand Encoding**

Op/En	Operand 1	Operand 2	Operand 3
RVR	ModRM:reg (w)	VEX.1vvv (r)	ModRM:r/m (r, ModRM:[7:6] must be 11b)

**Description**

Adds the vector mask k2 and the vector mask k3, and writes the result into vector mask k1.

**Operation****KADDW**
 $DEST[15:0] \leftarrow SRC1[15:0] + SRC2[15:0]$ 
 $DEST[MAX\_KL-1:16] \leftarrow 0$ 
**KADDB**
 $DEST[7:0] \leftarrow SRC1[7:0] + SRC2[7:0]$ 
 $DEST[MAX\_KL-1:8] \leftarrow 0$ 
**KADDQ**
 $DEST[63:0] \leftarrow SRC1[63:0] + SRC2[63:0]$ 
 $DEST[MAX\_KL-1:64] \leftarrow 0$ 
**KADD**
 $DEST[31:0] \leftarrow SRC1[31:0] + SRC2[31:0]$ 
 $DEST[MAX\_KL-1:32] \leftarrow 0$ 
**Intel C/C++ Compiler Intrinsic Equivalent****SIMD Floating-Point Exceptions**

None

**Other Exceptions**

See Exceptions Type K20.

## KANDW/KANDB/KANDQ/KANDD—Bitwise Logical AND Masks

Opcode/ Instruction	Op/En	64/32 bit Mode Support	CPUID Feature Flag	Description
VEX.NDS.L1.0F.W0 41 /r KANDW k1, k2, k3	RVR	V/V	AVX512F	Bitwise AND 16 bits masks k2 and k3 and place result in k1.
VEX.L1.66.0F.W0 41 /r KANDB k1, k2, k3	RVR	V/V	AVX512DQ	Bitwise AND 8 bits masks k2 and k3 and place result in k1.
VEX.L1.0F.W1 41 /r KANDQ k1, k2, k3	RVR	V/V	AVX512BW	Bitwise AND 64 bits masks k2 and k3 and place result in k1.
VEX.L1.66.0F.W1 41 /r KANDD k1, k2, k3	RVR	V/V	AVX512BW	Bitwise AND 32 bits masks k2 and k3 and place result in k1.

### Instruction Operand Encoding

Op/En	Operand 1	Operand 2	Operand 3
RVR	ModRM:reg (w)	VEX.1vsv (r)	ModRM:r/m (r, ModRM:[7:6] must be 11b)

### Description

Performs a bitwise AND between the vector mask k2 and the vector mask k3, and writes the result into vector mask k1.

### Operation

#### KANDW

DEST[15:0] ← SRC1[15:0] BITWISE AND SRC2[15:0]  
DEST[MAX\_KL-1:16] ← 0

#### KANDB

DEST[7:0] ← SRC1[7:0] BITWISE AND SRC2[7:0]  
DEST[MAX\_KL-1:8] ← 0

#### KANDQ

DEST[63:0] ← SRC1[63:0] BITWISE AND SRC2[63:0]  
DEST[MAX\_KL-1:64] ← 0

#### KANDD

DEST[31:0] ← SRC1[31:0] BITWISE AND SRC2[31:0]  
DEST[MAX\_KL-1:32] ← 0

### Intel C/C++ Compiler Intrinsic Equivalent

KANDW `__mmask16 _mm512_kand(__mmask16 a, __mmask16 b);`

### Flags Affected

None

### SIMD Floating-Point Exceptions

None

### Other Exceptions

See Exceptions Type K20.

**KANDNW/KANDNB/KANDNQ/KANDND—Bitwise Logical AND NOT Masks**

Opcode/ Instruction	Op/En	64/32 bit Mode Support	CPUID Feature Flag	Description
VEX.NDS.L1.0F.W0 42 /r KANDNW k1, k2, k3	RVR	V/V	AVX512F	Bitwise AND NOT 16 bits masks k2 and k3 and place result in k1.
VEX.L1.66.0F.W0 42 /r KANDNB k1, k2, k3	RVR	V/V	AVX512DQ	Bitwise AND NOT 8 bits masks k1 and k2 and place result in k1.
VEX.L1.0F.W1 42 /r KANDNQ k1, k2, k3	RVR	V/V	AVX512BW	Bitwise AND NOT 64 bits masks k2 and k3 and place result in k1.
VEX.L1.66.0F.W1 42 /r KANDND k1, k2, k3	RVR	V/V	AVX512BW	Bitwise AND NOT 32 bits masks k2 and k3 and place result in k1.

**Instruction Operand Encoding**

Op/En	Operand 1	Operand 2	Operand 3
RVR	ModRM:reg (w)	VEX.1vvv (r)	ModRM:r/m (r, ModRM:[7:6] must be 11b)

**Description**

Performs a bitwise AND NOT between the vector mask k2 and the vector mask k3, and writes the result into vector mask k1.

**Operation****KANDNW**

DEST[15:0] ← (BITWISE NOT SRC1[15:0]) BITWISE AND SRC2[15:0]  
DEST[MAX\_KL-1:16] ← 0

**KANDNB**

DEST[7:0] ← (BITWISE NOT SRC1[7:0]) BITWISE AND SRC2[7:0]  
DEST[MAX\_KL-1:8] ← 0

**KANDNQ**

DEST[63:0] ← (BITWISE NOT SRC1[63:0]) BITWISE AND SRC2[63:0]  
DEST[MAX\_KL-1:64] ← 0

**KANDND**

DEST[31:0] ← (BITWISE NOT SRC1[31:0]) BITWISE AND SRC2[31:0]  
DEST[MAX\_KL-1:32] ← 0

**Intel C/C++ Compiler Intrinsic Equivalent**

KANDNW \_\_mmask16 \_mm512\_kandn(\_\_mmask16 a, \_\_mmask16 b);

**Flags Affected**

None

**SIMD Floating-Point Exceptions**

None

**Other Exceptions**

See Exceptions Type K20.

## KMOVW/KMOVB/KMOVQ/KMOVD—Move from and to Mask Registers

Opcode/ Instruction	Op/En	64/32 bit Mode Support	CPUID Feature Flag	Description
VEX.L0.0F.W0 90 /r KMOVW k1, k2/m16	RM	V/V	AVX512F	Move 16 bits mask from k2/m16 and store the result in k1.
VEX.L0.66.0F.W0 90 /r KMOVB k1, k2/m8	RM	V/V	AVX512DQ	Move 8 bits mask from k2/m8 and store the result in k1.
VEX.L0.0F.W1 90 /r KMOVQ k1, k2/m64	RM	V/V	AVX512BW	Move 64 bits mask from k2/m64 and store the result in k1.
VEX.L0.66.0F.W1 90 /r KMOVD k1, k2/m32	RM	V/V	AVX512BW	Move 32 bits mask from k2/m32 and store the result in k1.
VEX.L0.0F.W0 91 /r KMOVW m16, k1	MR	V/V	AVX512F	Move 16 bits mask from k1 and store the result in m16.
VEX.L0.66.0F.W0 91 /r KMOVB m8, k1	MR	V/V	AVX512DQ	Move 8 bits mask from k1 and store the result in m8.
VEX.L0.0F.W1 91 /r KMOVQ m64, k1	MR	V/V	AVX512BW	Move 64 bits mask from k1 and store the result in m64.
VEX.L0.66.0F.W1 91 /r KMOVD m32, k1	MR	V/V	AVX512BW	Move 32 bits mask from k1 and store the result in m32.
VEX.L0.0F.W0 92 /r KMOVW k1, r32	RR	V/V	AVX512F	Move 16 bits mask from r32 to k1.
VEX.L0.66.0F.W0 92 /r KMOVB k1, r32	RR	V/V	AVX512DQ	Move 8 bits mask from r32 to k1.
VEX.L0.F2.0F.W1 92 /r KMOVQ k1, r64	RR	V/I	AVX512BW	Move 64 bits mask from r64 to k1.
VEX.L0.F2.0F.W0 92 /r KMOVD k1, r32	RR	V/V	AVX512BW	Move 32 bits mask from r32 to k1.
VEX.L0.0F.W0 93 /r KMOVW r32, k1	RR	V/V	AVX512F	Move 16 bits mask from k1 to r32.
VEX.L0.66.0F.W0 93 /r KMOVB r32, k1	RR	V/V	AVX512DQ	Move 8 bits mask from k1 to r32.
VEX.L0.F2.0F.W1 93 /r KMOVQ r64, k1	RR	V/I	AVX512BW	Move 64 bits mask from k1 to r64.
VEX.L0.F2.0F.W0 93 /r KMOVD r32, k1	RR	V/V	AVX512BW	Move 32 bits mask from k1 to r32.

### Instruction Operand Encoding

Op/En	Operand 1	Operand 2
RM	ModRM:reg (w)	ModRM:r/m (r)
MR	ModRM:r/m (w, ModRM:[7:6] must not be 11b)	ModRM:reg (r)
RR	ModRM:reg (w)	ModRM:r/m (r, ModRM:[7:6] must be 11b)

### Description

Copies values from the source operand (second operand) to the destination operand (first operand). The source and destination operands can be mask registers, memory location or general purpose. The instruction cannot be used to transfer data between general purpose registers and or memory locations.

When moving to a mask register, the result is zero extended to MAX\_KL size (i.e., 64 bits currently). When moving to a general-purpose register (GPR), the result is zero-extended to the size of the destination. In 32-bit mode, the default GPR destination's size is 32 bits. In 64-bit mode, the default GPR destination's size is 64 bits. Note that VEX.W can only be used to modify the size of the GPR operand in 64b mode.

**Operation****KMOVW**

IF \*destination is a memory location\*

$$\text{DEST}[15:0] \leftarrow \text{SRC}[15:0]$$

IF \*destination is a mask register or a GPR \*

$$\text{DEST} \leftarrow \text{ZeroExtension}(\text{SRC}[15:0])$$
**KMOVB**

IF \*destination is a memory location\*

$$\text{DEST}[7:0] \leftarrow \text{SRC}[7:0]$$

IF \*destination is a mask register or a GPR \*

$$\text{DEST} \leftarrow \text{ZeroExtension}(\text{SRC}[7:0])$$
**KMOVQ**

IF \*destination is a memory location or a GPR\*

$$\text{DEST}[63:0] \leftarrow \text{SRC}[63:0]$$

IF \*destination is a mask register\*

$$\text{DEST} \leftarrow \text{ZeroExtension}(\text{SRC}[63:0])$$
**KMOVD**

IF \*destination is a memory location\*

$$\text{DEST}[31:0] \leftarrow \text{SRC}[31:0]$$

IF \*destination is a mask register or a GPR \*

$$\text{DEST} \leftarrow \text{ZeroExtension}(\text{SRC}[31:0])$$
**Intel C/C++ Compiler Intrinsic Equivalent**

KMOVW `__mmask16 _mm512_kmov(__mmask16 a);`

**Flags Affected**

None

**SIMD Floating-Point Exceptions**

None

**Other Exceptions**

Instructions with RR operand encoding See Exceptions Type K20.

Instructions with RM or MR operand encoding See Exceptions Type K21.

**KNOTW/KNOTB/KNOTQ/KNOTD—NOT Mask Register**

Opcode/ Instruction	Op/En	64/32 bit Mode Support	CPUID Feature Flag	Description
VEX.L0.0F.W0 44 /r KNOTW k1, k2	RR	V/V	AVX512F	Bitwise NOT of 16 bits mask k2.
VEX.L0.66.0F.W0 44 /r KNOTB k1, k2	RR	V/V	AVX512DQ	Bitwise NOT of 8 bits mask k2.
VEX.L0.0F.W1 44 /r KNOTQ k1, k2	RR	V/V	AVX512BW	Bitwise NOT of 64 bits mask k2.
VEX.L0.66.0F.W1 44 /r KNOTD k1, k2	RR	V/V	AVX512BW	Bitwise NOT of 32 bits mask k2.

**Instruction Operand Encoding**

Op/En	Operand 1	Operand 2
RR	ModRM:reg (w)	ModRM:r/m (r, ModRM:[7:6] must be 11b)

**Description**

Performs a bitwise NOT of vector mask k2 and writes the result into vector mask k1.

**Operation****KNOTW**

DEST[15:0] ← BITWISE NOT SRC[15:0]

DEST[MAX\_KL-1:16] ← 0

**KNOTB**

DEST[7:0] ← BITWISE NOT SRC[7:0]

DEST[MAX\_KL-1:8] ← 0

**KNOTQ**

DEST[63:0] ← BITWISE NOT SRC[63:0]

DEST[MAX\_KL-1:64] ← 0

**KNOTD**

DEST[31:0] ← BITWISE NOT SRC[31:0]

DEST[MAX\_KL-1:32] ← 0

**Intel C/C++ Compiler Intrinsic Equivalent**

KNOTW `__mmask16 _mm512_knot(__mmask16 a);`

**Flags Affected**

None

**SIMD Floating-Point Exceptions**

None

**Other Exceptions**

See Exceptions Type K20.

**KORW/KORB/KORQ/KORD—Bitwise Logical OR Masks**

Opcode/ Instruction	Op/En	64/32 bit Mode Support	CPUID Feature Flag	Description
VEX.NDS.L1.0F.W0 45 /r KORW k1, k2, k3	RVR	V/V	AVX512F	Bitwise OR 16 bits masks k2 and k3 and place result in k1.
VEX.L1.66.0F.W0 45 /r KORB k1, k2, k3	RVR	V/V	AVX512DQ	Bitwise OR 8 bits masks k2 and k3 and place result in k1.
VEX.L1.0F.W1 45 /r KORQ k1, k2, k3	RVR	V/V	AVX512BW	Bitwise OR 64 bits masks k2 and k3 and place result in k1.
VEX.L1.66.0F.W1 45 /r KORD k1, k2, k3	RVR	V/V	AVX512BW	Bitwise OR 32 bits masks k2 and k3 and place result in k1.

**Instruction Operand Encoding**

Op/En	Operand 1	Operand 2	Operand 3
RVR	ModRM:reg (w)	VEX.1 vvv (r)	ModRM:r/m (r, ModRM:[7:6] must be 11b)

**Description**

Performs a bitwise OR between the vector mask k2 and the vector mask k3, and writes the result into vector mask k1 (three-operand form).

**Operation****KORW**

DEST[15:0] ← SRC1[15:0] BITWISE OR SRC2[15:0]  
DEST[MAX\_KL-1:16] ← 0

**KORB**

DEST[7:0] ← SRC1[7:0] BITWISE OR SRC2[7:0]  
DEST[MAX\_KL-1:8] ← 0

**KORQ**

DEST[63:0] ← SRC1[63:0] BITWISE OR SRC2[63:0]  
DEST[MAX\_KL-1:64] ← 0

**KORD**

DEST[31:0] ← SRC1[31:0] BITWISE OR SRC2[31:0]  
DEST[MAX\_KL-1:32] ← 0

**Intel C/C++ Compiler Intrinsic Equivalent**

KORW `__mmask16 _mm512_kor(__mmask16 a, __mmask16 b);`

**Flags Affected**

None

**SIMD Floating-Point Exceptions**

None

**Other Exceptions**

See Exceptions Type K20.



## KORTESTW/KORTESTB/KORTESTQ/KORTESTD—OR Masks And Set Flags

Opcode/ Instruction	Op/ En	64/32 bit Mode Support	CPUID Feature Flag	Description
VEX.L0.0F.W0 98 /r KORTESTW k1, k2	RR	V/V	AVX512F	Bitwise OR 16 bits masks k1 and k2 and update ZF and CF accordingly.
VEX.L0.66.0F.W0 98 /r KORTESTB k1, k2	RR	V/V	AVX512DQ	Bitwise OR 8 bits masks k1 and k2 and update ZF and CF accordingly.
VEX.L0.0F.W1 98 /r KORTESTQ k1, k2	RR	V/V	AVX512BW	Bitwise OR 64 bits masks k1 and k2 and update ZF and CF accordingly.
VEX.L0.66.0F.W1 98 /r KORTESTD k1, k2	RR	V/V	AVX512BW	Bitwise OR 32 bits masks k1 and k2 and update ZF and CF accordingly.

### Instruction Operand Encoding

Op/En	Operand 1	Operand 2
RR	ModRM:reg (w)	ModRM:r/m (r, ModRM:[7:6] must be 11b)

### Description

Performs a bitwise OR between the vector mask register k2, and the vector mask register k1, and sets CF and ZF based on the operation result.

ZF flag is set if both sources are 0x0. CF is set if, after the OR operation is done, the operation result is all 1's.

### Operation

#### KORTESTW

TMP[15:0] ← DEST[15:0] BITWISE OR SRC[15:0]

IF(TMP[15:0]=0)  
THEN ZF ← 1  
ELSE ZF ← 0

FI;  
IF(TMP[15:0]=FFFFh)  
THEN CF ← 1  
ELSE CF ← 0

FI;

#### KORTESTB

TMP[7:0] ← DEST[7:0] BITWISE OR SRC[7:0]

IF(TMP[7:0]=0)  
THEN ZF ← 1  
ELSE ZF ← 0

FI;  
IF(TMP[7:0]=FFh)  
THEN CF ← 1  
ELSE CF ← 0

FI;

**KORTESTQ**

TMP[63:0] ← DEST[63:0] BITWISE OR SRC[63:0]

IF(TMP[63:0]=0)

THEN ZF ← 1

ELSE ZF ← 0

FI;

IF(TMP[63:0]==FFFFFFFF\_FFFFFFFFh)

THEN CF ← 1

ELSE CF ← 0

FI;

**KORTESTD**

TMP[31:0] ← DEST[31:0] BITWISE OR SRC[31:0]

IF(TMP[31:0]=0)

THEN ZF ← 1

ELSE ZF ← 0

FI;

IF(TMP[31:0]=FFFFFFFFh)

THEN CF ← 1

ELSE CF ← 0

FI;

**Intel C/C++ Compiler Intrinsic Equivalent**

KORTESTW \_\_mmask16 \_mm512\_kortest[cz](\_\_mmask16 a, \_\_mmask16 b);

**Flags Affected**

The ZF flag is set if the result of OR-ing both sources is all 0s.

The CF flag is set if the result of OR-ing both sources is all 1s.

The OF, SF, AF, and PF flags are set to 0.

**Other Exceptions**

See Exceptions Type K20.

## KSHIFTLW/KSHIFTLB/KSHIFTLQ/KSHIFTLD—Shift Left Mask Registers

Opcode/ Instruction	Op/En	64/32 bit Mode Support	CPUID Feature Flag	Description
VEX.L0.66.0F3A.W1 32 /r KSHIFTLW k1, k2, imm8	RRI	V/V	AVX512F	Shift left 16 bits in k2 by immediate and write result in k1.
VEX.L0.66.0F3A.W0 32 /r KSHIFTLB k1, k2, imm8	RRI	V/V	AVX512DQ	Shift left 8 bits in k2 by immediate and write result in k1.
VEX.L0.66.0F3A.W1 33 /r KSHIFTLQ k1, k2, imm8	RRI	V/V	AVX512BW	Shift left 64 bits in k2 by immediate and write result in k1.
VEX.L0.66.0F3A.W0 33 /r KSHIFTLD k1, k2, imm8	RRI	V/V	AVX512BW	Shift left 32 bits in k2 by immediate and write result in k1.

### Instruction Operand Encoding

Op/En	Operand 1	Operand 2	Operand 3
RRI	ModRM:reg (w)	ModRM:r/m (r, ModRM:[7:6] must be 11b)	Imm8

### Description

Shifts 8/16/32/64 bits in the second operand (source operand) left by the count specified in immediate byte and place the least significant 8/16/32/64 bits of the result in the destination operand. The higher bits of the destination are zero-extended. The destination is set to zero if the count value is greater than 7 (for byte shift), 15 (for word shift), 31 (for doubleword shift) or 63 (for quadword shift).

### Operation

#### KSHIFTLW

```
COUNT ← imm8[7:0]
DEST[MAX_KL-1:0] ← 0
IF COUNT ≤ 15
    THEN DEST[15:0] ← SRC1[15:0] << COUNT;
FI;
```

#### KSHIFTLB

```
COUNT ← imm8[7:0]
DEST[MAX_KL-1:0] ← 0
IF COUNT ≤ 7
    THEN DEST[7:0] ← SRC1[7:0] << COUNT;
FI;
```

#### KSHIFTLQ

```
COUNT ← imm8[7:0]
DEST[MAX_KL-1:0] ← 0
IF COUNT ≤ 63
    THEN DEST[63:0] ← SRC1[63:0] << COUNT;
FI;
```

### **KSHIFTLD**

COUNT  $\leftarrow$  imm8[7:0]

DEST[MAX\_KL-1:0]  $\leftarrow$  0

IF COUNT  $\leq$  31

    THEN DEST[31:0]  $\leftarrow$  SRC1[31:0]  $\ll$  COUNT;  
FI;

### **Intel C/C++ Compiler Intrinsic Equivalent**

Compiler auto generates KSHIFTLW when needed.

### **Flags Affected**

None

### **SIMD Floating-Point Exceptions**

None

### **Other Exceptions**

See Exceptions Type K20.

## KSHIFTRW/KSHIFTRB/KSHIFTRQ/KSHIFTRD—Shift Right Mask Registers

Opcode/ Instruction	Op/En	64/32 bit Mode Support	CPUID Feature Flag	Description
VEX.L0.66.0F3A.W1 30 /r KSHIFTRW k1, k2, imm8	RRI	V/V	AVX512F	Shift right 16 bits in k2 by immediate and write result in k1.
VEX.L0.66.0F3A.W0 30 /r KSHIFTRB k1, k2, imm8	RRI	V/V	AVX512DQ	Shift right 8 bits in k2 by immediate and write result in k1.
VEX.L0.66.0F3A.W1 31 /r KSHIFTRQ k1, k2, imm8	RRI	V/V	AVX512BW	Shift right 64 bits in k2 by immediate and write result in k1.
VEX.L0.66.0F3A.W0 31 /r KSHIFTRD k1, k2, imm8	RRI	V/V	AVX512BW	Shift right 32 bits in k2 by immediate and write result in k1.

### Instruction Operand Encoding

Op/En	Operand 1	Operand 2	Operand 3
RRI	ModRM:reg (w)	ModRM:r/m (r, ModRM:[7:6] must be 11b)	Imm8

### Description

Shifts 8/16/32/64 bits in the second operand (source operand) right by the count specified in immediate and place the least significant 8/16/32/64 bits of the result in the destination operand. The higher bits of the destination are zero-extended. The destination is set to zero if the count value is greater than 7 (for byte shift), 15 (for word shift), 31 (for doubleword shift) or 63 (for quadword shift).

### Operation

#### KSHIFTRW

```
COUNT ← imm8[7:0]
DEST[MAX_KL-1:0] ← 0
IF COUNT ≤ 15
    THEN DEST[15:0] ← SRC1[15:0] >> COUNT;
FI;
```

#### KSHIFTRB

```
COUNT ← imm8[7:0]
DEST[MAX_KL-1:0] ← 0
IF COUNT ≤ 7
    THEN DEST[7:0] ← SRC1[7:0] >> COUNT;
FI;
```

#### KSHIFTRQ

```
COUNT ← imm8[7:0]
DEST[MAX_KL-1:0] ← 0
IF COUNT ≤ 63
    THEN DEST[63:0] ← SRC1[63:0] >> COUNT;
FI;
```

### **KSHIFTRD**

COUNT  $\leftarrow$  imm8[7:0]

DEST[MAX\_KL-1:0]  $\leftarrow$  0

IF COUNT  $\leq$  31

THEN DEST[31:0]  $\leftarrow$  SRC1[31:0]  $\gg$  COUNT;

FI;

### **Intel C/C++ Compiler Intrinsic Equivalent**

Compiler auto generates KSHIFTRW when needed.

### **Flags Affected**

None

### **SIMD Floating-Point Exceptions**

None

### **Other Exceptions**

See Exceptions Type K20.

## KTESTW/KTESTB/KTESTQ/KTESTD—Packed Bit Test Masks and Set Flags

Opcode/ Instruction	Op En	64/32 bit Mode Support	CPUID Feature Flag	Description
VEX.L0.0F.W0 99 /r KTESTW k1, k2	RR	V/V	AVX512DQ	Set ZF and CF depending on sign bit AND and ANDN of 16 bits mask register sources.
VEX.L0.66.0F.W0 99 /r KTESTB k1, k2	RR	V/V	AVX512DQ	Set ZF and CF depending on sign bit AND and ANDN of 8 bits mask register sources.
VEX.L0.0F.W1 99 /r KTESTQ k1, k2	RR	V/V	AVX512BW	Set ZF and CF depending on sign bit AND and ANDN of 64 bits mask register sources.
VEX.L0.66.0F.W1 99 /r KTESTD k1, k2	RR	V/V	AVX512BW	Set ZF and CF depending on sign bit AND and ANDN of 32 bits mask register sources.

### Instruction Operand Encoding

Op/En	Operand 1	Operand2
RR	ModRM:reg (r)	ModRM:r/m (r, ModRM:[7:6] must be 11b)

### Description

Performs a bitwise comparison of the bits of the first source operand and corresponding bits in the second source operand. If the AND operation produces all zeros, the ZF is set else the ZF is clear. If the bitwise AND operation of the inverted first source operand with the second source operand produces all zeros the CF is set else the CF is clear. Only the EFLAGS register is updated.

Note: In VEX-encoded versions, VEX.vvvv is reserved and must be 1111b, otherwise instructions will #UD.

### Operation

#### KTESTW

TEMP[15:0] ← SRC2[15:0] AND SRC1[15:0]

IF (TEMP[15:0] == 0)

THEN ZF ← 1;

ELSE ZF ← 0;

FI;

TEMP[15:0] ← SRC2[15:0] AND NOT SRC1[15:0]

IF (TEMP[15:0] == 0)

THEN CF ← 1;

ELSE CF ← 0;

FI;

AF ← OF ← PF ← SF ← 0;

#### KTESTB

TEMP[7:0] ← SRC2[7:0] AND SRC1[7:0]

IF (TEMP[7:0] == 0)

THEN ZF ← 1;

ELSE ZF ← 0;

FI;

TEMP[7:0] ← SRC2[7:0] AND NOT SRC1[7:0]

IF (TEMP[7:0] == 0)

THEN CF ← 1;

ELSE CF ← 0;

FI;

AF ← OF ← PF ← SF ← 0;

**KTESTQ**

TEMP[63:0] ← SRC2[63:0] AND SRC1[63:0]

IF (TEMP[63:0] == 0)

    THEN ZF ← 1;

    ELSE ZF ← 0;

FI;

TEMP[63:0] ← SRC2[63:0] AND NOT SRC1[63:0]

IF (TEMP[63:0] == 0)

    THEN CF ← 1;

    ELSE CF ← 0;

FI;

AF ← OF ← PF ← SF ← 0;

**KTESTD**

TEMP[31:0] ← SRC2[31:0] AND SRC1[31:0]

IF (TEMP[31:0] == 0)

    THEN ZF ← 1;

    ELSE ZF ← 0;

FI;

TEMP[31:0] ← SRC2[31:0] AND NOT SRC1[31:0]

IF (TEMP[31:0] == 0)

    THEN CF ← 1;

    ELSE CF ← 0;

FI;

AF ← OF ← PF ← SF ← 0;

**Intel C/C++ Compiler Intrinsic Equivalent**

**SIMD Floating-Point Exceptions**

None

**Other Exceptions**

See Exceptions Type K20.



## KUNPCKBW/KUNPCKWD/KUNPCKDQ—Unpack for Mask Registers

Opcode/ Instruction	Op/En	64/32 bit Mode Support	CPUID Feature Flag	Description
VEX.NDS.L1.66.0F.W0 4B /r KUNPCKBW k1, k2, k3	RVR	V/V	AVX512F	Unpack and interleave 8 bits masks in k2 and k3 and write word result in k1.
VEX.NDS.L1.0F.W0 4B /r KUNPCKWD k1, k2, k3	RVR	V/V	AVX512BW	Unpack and interleave 16 bits in k2 and k3 and write double-word result in k1.
VEX.NDS.L1.0F.W1 4B /r KUNPCKDQ k1, k2, k3	RVR	V/V	AVX512BW	Unpack and interleave 32 bits masks in k2 and k3 and write quadword result in k1.

### Instruction Operand Encoding

Op/En	Operand 1	Operand 2	Operand 3
RVR	ModRM:reg (w)	VEX.1vvv (r)	ModRM:r/m (r, ModRM:[7:6] must be 11b)

### Description

Unpacks the lower 8/16/32 bits of the second and third operands (source operands) into the low part of the first operand (destination operand), starting from the low bytes. The result is zero-extended in the destination.

### Operation

#### KUNPCKBW

```
DEST[7:0] ← SRC2[7:0]
DEST[15:8] ← SRC1[7:0]
DEST[MAX_KL-1:16] ← 0
```

#### KUNPCKWD

```
DEST[15:0] ← SRC2[15:0]
DEST[31:16] ← SRC1[15:0]
DEST[MAX_KL-1:32] ← 0
```

#### KUNPCKDQ

```
DEST[31:0] ← SRC2[31:0]
DEST[63:32] ← SRC1[31:0]
DEST[MAX_KL-1:64] ← 0
```

### Intel C/C++ Compiler Intrinsic Equivalent

```
KUNPCKBW __mmask16 __mm512_kunpackb(__mmask16 a, __mmask16 b);
KUNPCKDQ __mmask64 __mm512_kunpackd(__mmask64 a, __mmask64 b);
KUNPCKWD __mmask32 __mm512_kunpackw(__mmask32 a, __mmask32 b);
```

### Flags Affected

None

### SIMD Floating-Point Exceptions

None

### Other Exceptions

See Exceptions Type K20.

**KXNORW/KXNORB/KXNORQ/KXNORD—Bitwise Logical XNOR Masks**

Opcode/ Instruction	Op/En	64/32 bit Mode Support	CPUID Feature Flag	Description
VEX.NDS.L1.0F.W0 46 /r KXNORW k1, k2, k3	RVR	V/V	AVX512F	Bitwise XNOR 16 bits masks k2 and k3 and place result in k1.
VEX.L1.66.0F.W0 46 /r KXNORB k1, k2, k3	RVR	V/V	AVX512DQ	Bitwise XNOR 8 bits masks k2 and k3 and place result in k1.
VEX.L1.0F.W1 46 /r KXNORQ k1, k2, k3	RVR	V/V	AVX512BW	Bitwise XNOR 64 bits masks k2 and k3 and place result in k1.
VEX.L1.66.0F.W1 46 /r KXNORD k1, k2, k3	RVR	V/V	AVX512BW	Bitwise XNOR 32 bits masks k2 and k3 and place result in k1.

**Instruction Operand Encoding**

Op/En	Operand 1	Operand 2	Operand 3
RVR	ModRM:reg (w)	VEX.1vvv (r)	ModRM:r/m (r, ModRM:[7:6] must be 11b)

**Description**

Performs a bitwise XNOR between the vector mask k2 and the vector mask k3, and writes the result into vector mask k1 (three-operand form).

**Operation****KXNORW**

DEST[15:0] ← NOT (SRC1[15:0] BITWISE XOR SRC2[15:0])  
DEST[MAX\_KL-1:16] ← 0

**KXNORB**

DEST[7:0] ← NOT (SRC1[7:0] BITWISE XOR SRC2[7:0])  
DEST[MAX\_KL-1:8] ← 0

**KXNORQ**

DEST[63:0] ← NOT (SRC1[63:0] BITWISE XOR SRC2[63:0])  
DEST[MAX\_KL-1:64] ← 0

**KXNORD**

DEST[31:0] ← NOT (SRC1[31:0] BITWISE XOR SRC2[31:0])  
DEST[MAX\_KL-1:32] ← 0

**Intel C/C++ Compiler Intrinsic Equivalent**

KXNORW \_\_mmask16 \_\_mm512\_kxnor(\_\_mmask16 a, \_\_mmask16 b);

**Flags Affected**

None

**SIMD Floating-Point Exceptions**

None

**Other Exceptions**

See Exceptions Type K20.

## KXORW/KXORB/KXORQ/KXORD—Bitwise Logical XOR Masks

Opcode/ Instruction	Op/En	64/32 bit Mode Support	CPUID Feature Flag	Description
VEX.NDS.L1.0F.W0 47 /r KXORW k1, k2, k3	RVR	V/V	AVX512F	Bitwise XOR 16 bits masks k2 and k3 and place result in k1.
VEX.L1.66.0F.W0 47 /r KXORB k1, k2, k3	RVR	V/V	AVX512DQ	Bitwise XOR 8 bits masks k2 and k3 and place result in k1.
VEX.L1.0F.W1 47 /r KXORQ k1, k2, k3	RVR	V/V	AVX512BW	Bitwise XOR 64 bits masks k2 and k3 and place result in k1.
VEX.L1.66.0F.W1 47 /r KXORD k1, k2, k3	RVR	V/V	AVX512BW	Bitwise XOR 32 bits masks k2 and k3 and place result in k1.

### Instruction Operand Encoding

Op/En	Operand 1	Operand 2	Operand 3
RVR	ModRM:reg (w)	VEX.1 vvv (r)	ModRM:r/m (r, ModRM:[7:6] must be 11b)

### Description

Performs a bitwise XOR between the vector mask k2 and the vector mask k3, and writes the result into vector mask k1 (three-operand form).

### Operation

#### KXORW

DEST[15:0] ← SRC1[15:0] BITWISE XOR SRC2[15:0]  
DEST[MAX\_KL-1:16] ← 0

#### KXORB

DEST[7:0] ← SRC1[7:0] BITWISE XOR SRC2[7:0]  
DEST[MAX\_KL-1:8] ← 0

#### KXORQ

DEST[63:0] ← SRC1[63:0] BITWISE XOR SRC2[63:0]  
DEST[MAX\_KL-1:64] ← 0

#### KXORD

DEST[31:0] ← SRC1[31:0] BITWISE XOR SRC2[31:0]  
DEST[MAX\_KL-1:32] ← 0

### Intel C/C++ Compiler Intrinsic Equivalent

KXORW \_\_mmask16 \_mm512\_kxor(\_\_mmask16 a, \_\_mmask16 b);

### Flags Affected

None

### SIMD Floating-Point Exceptions

None

### Other Exceptions

See Exceptions Type K20.

**LAHF—Load Status Flags into AH Register**

Opcode	Instruction	Op/En	64-Bit Mode	Compat/Leg Mode	Description
9F	LAHF	Z0	Invalid*	Valid	Load: AH ← EFLAGS(SF:ZF:0:AF:0:PF:1:CF).

**NOTES:**

\*Valid in specific steppings. See Description section.

**Instruction Operand Encoding**

Op/En	Operand 1	Operand 2	Operand 3	Operand 4
Z0	NA	NA	NA	NA

**Description**

This instruction executes as described above in compatibility mode and legacy mode. It is valid in 64-bit mode only if CPUID.80000001H:ECX.LAHF-SAHF[bit 0] = 1.

**Operation**

```
IF 64-Bit Mode
  THEN
    IF CPUID.80000001H:ECX.LAHF-SAHF[bit 0] = 1;
      THEN AH ← RFLAGS(SF:ZF:0:AF:0:PF:1:CF);
      ELSE #UD;
    FI;
  ELSE
    AH ← EFLAGS(SF:ZF:0:AF:0:PF:1:CF);
  FI;
```

**Flags Affected**

None. The state of the flags in the EFLAGS register is not affected.

**Protected Mode Exceptions**

#UD If the LOCK prefix is used.

**Real-Address Mode Exceptions**

Same exceptions as in protected mode.

**Virtual-8086 Mode Exceptions**

Same exceptions as in protected mode.

**Compatibility Mode Exceptions**

Same exceptions as in protected mode.

**64-Bit Mode Exceptions**

#UD If CPUID.80000001H:ECX.LAHF-SAHF[bit 0] = 0.  
If the LOCK prefix is used.

## LAR—Load Access Rights Byte

Opcode	Instruction	Op/En	64-Bit Mode	Compat/Leg Mode	Description
OF 02 /r	LAR r16, r16/m16	RM	Valid	Valid	r16 ← access rights referenced by r16/m16
OF 02 /r	LAR reg, r32/m16 <sup>1</sup>	RM	Valid	Valid	reg ← access rights referenced by r32/m16

### NOTES:

1. For all loads (regardless of source or destination sizing) only bits 16-0 are used. Other bits are ignored.

### Instruction Operand Encoding

Op/En	Operand 1	Operand 2	Operand 3	Operand 4
RM	ModRM:reg (w)	ModRM:r/m (r)	NA	NA

### Description

Loads the access rights from the segment descriptor specified by the second operand (source operand) into the first operand (destination operand) and sets the ZF flag in the flag register. The source operand (which can be a register or a memory location) contains the segment selector for the segment descriptor being accessed. If the source operand is a memory address, only 16 bits of data are accessed. The destination operand is a general-purpose register.

The processor performs access checks as part of the loading process. Once loaded in the destination register, software can perform additional checks on the access rights information.

The access rights for a segment descriptor include fields located in the second doubleword (bytes 4–7) of the segment descriptor. The following fields are loaded by the LAR instruction:

- Bits 7:0 are returned as 0
- Bits 11:8 return the segment type.
- Bit 12 returns the S flag.
- Bits 14:13 return the DPL.
- Bit 15 returns the P flag.
- The following fields are returned only if the operand size is greater than 16 bits:
  - Bits 19:16 are undefined.
  - Bit 20 returns the software-available bit in the descriptor.
  - Bit 21 returns the L flag.
  - Bit 22 returns the D/B flag.
  - Bit 23 returns the G flag.
  - Bits 31:24 are returned as 0.

This instruction performs the following checks before it loads the access rights in the destination register:

- Checks that the segment selector is not NULL.
- Checks that the segment selector points to a descriptor that is within the limits of the GDT or LDT being accessed
- Checks that the descriptor type is valid for this instruction. All code and data segment descriptors are valid for (can be accessed with) the LAR instruction. The valid system segment and gate descriptor types are given in Table 3-52.
- If the segment is not a conforming code segment, it checks that the specified segment descriptor is visible at the CPL (that is, if the CPL and the RPL of the segment selector are less than or equal to the DPL of the segment selector).

If the segment descriptor cannot be accessed or is an invalid type for the instruction, the ZF flag is cleared and no access rights are loaded in the destination operand.

The LAR instruction can only be executed in protected mode and IA-32e mode.

**Table 3-52. Segment and Gate Types**

Type	Protected Mode		IA-32e Mode	
	Name	Valid	Name	Valid
0	Reserved	No	Reserved	No
1	Available 16-bit TSS	Yes	Reserved	No
2	LDT	Yes	LDT	Yes
3	Busy 16-bit TSS	Yes	Reserved	No
4	16-bit call gate	Yes	Reserved	No
5	16-bit/32-bit task gate	Yes	Reserved	No
6	16-bit interrupt gate	No	Reserved	No
7	16-bit trap gate	No	Reserved	No
8	Reserved	No	Reserved	No
9	Available 32-bit TSS	Yes	Available 64-bit TSS	Yes
A	Reserved	No	Reserved	No
B	Busy 32-bit TSS	Yes	Busy 64-bit TSS	Yes
C	32-bit call gate	Yes	64-bit call gate	Yes
D	Reserved	No	Reserved	No
E	32-bit interrupt gate	No	64-bit interrupt gate	No
F	32-bit trap gate	No	64-bit trap gate	No

### Operation

IF Offset(SRC) > descriptor table limit

THEN

ZF ← 0;

ELSE

SegmentDescriptor ← descriptor referenced by SRC;

IF SegmentDescriptor(Type) ≠ conforming code segment

and (CPL > DPL) or (RPL > DPL)

or SegmentDescriptor(Type) is not valid for instruction

THEN

ZF ← 0;

ELSE

DEST ← access rights from SegmentDescriptor as given in Description section;

ZF ← 1;

FI;

FI;

### Flags Affected

The ZF flag is set to 1 if the access rights are loaded successfully; otherwise, it is cleared to 0.

**Protected Mode Exceptions**

#GP(0)	If a memory operand effective address is outside the CS, DS, ES, FS, or GS segment limit. If the DS, ES, FS, or GS register is used to access memory and it contains a NULL segment selector.
#SS(0)	If a memory operand effective address is outside the SS segment limit.
#PF(fault-code)	If a page fault occurs.
#AC(0)	If alignment checking is enabled and the memory operand effective address is unaligned while the current privilege level is 3.
#UD	If the LOCK prefix is used.

**Real-Address Mode Exceptions**

#UD	The LAR instruction is not recognized in real-address mode.
-----	---

**Virtual-8086 Mode Exceptions**

#UD	The LAR instruction cannot be executed in virtual-8086 mode.
-----	--

**Compatibility Mode Exceptions**

Same exceptions as in protected mode.

**64-Bit Mode Exceptions**

#SS(0)	If the memory operand effective address referencing the SS segment is in a non-canonical form.
#GP(0)	If the memory operand effective address is in a non-canonical form.
#PF(fault-code)	If a page fault occurs.
#AC(0)	If alignment checking is enabled and the memory operand effective address is unaligned while the current privilege level is 3.
#UD	If the LOCK prefix is used.

## LDDQU—Load Unaligned Integer 128 Bits

Opcode/ Instruction	Op/ En	64/32-bit Mode	CPUID Feature Flag	Description
F2 0F F0 /r LDDQU <i>xmm1</i> , <i>mem</i>	RM	V/V	SSE3	Load unaligned data from <i>mem</i> and return double quadword in <i>xmm1</i> .
VEX.128.F2.0F.WIG F0 /r VLDDQU <i>xmm1</i> , <i>m128</i>	RM	V/V	AVX	Load unaligned packed integer values from <i>mem</i> to <i>xmm1</i> .
VEX.256.F2.0F.WIG F0 /r VLDDQU <i>ymm1</i> , <i>m256</i>	RM	V/V	AVX	Load unaligned packed integer values from <i>mem</i> to <i>ymm1</i> .

### Instruction Operand Encoding

Op/En	Operand 1	Operand 2	Operand 3	Operand 4
RM	ModRM:reg (w)	ModRM:r/m (r)	NA	NA

### Description

The instruction is *functionally similar* to (V)MOVDQU *ymm/xmm*, *m256/m128* for loading from memory. That is: 32/16 bytes of data starting at an address specified by the source memory operand (second operand) are fetched from memory and placed in a destination register (first operand). The source operand need not be aligned on a 32/16-byte boundary. Up to 64/32 bytes may be loaded from memory; this is implementation dependent.

This instruction may improve performance relative to (V)MOVDQU if the source operand crosses a cache line boundary. In situations that require the data loaded by (V)LDDQU be modified and stored to the same location, use (V)MOVDQU or (V)MOVDQA instead of (V)LDDQU. To move a double quadword to or from memory locations that are known to be aligned on 16-byte boundaries, use the (V)MOVDQA instruction.

### Implementation Notes

- If the source is aligned to a 32/16-byte boundary, based on the implementation, the 32/16 bytes may be loaded more than once. For that reason, the usage of (V)LDDQU should be avoided when using uncached or write-combining (WC) memory regions. For uncached or WC memory regions, keep using (V)MOVDQU.
- This instruction is a replacement for (V)MOVDQU (load) in situations where cache line splits significantly affect performance. It should not be used in situations where store-load forwarding is performance critical. If performance of store-load forwarding is critical to the application, use (V)MOVDQA store-load pairs when data is 256/128-bit aligned or (V)MOVDQU store-load pairs when data is 256/128-bit unaligned.
- If the memory address is not aligned on 32/16-byte boundary, some implementations may load up to 64/32 bytes and return 32/16 bytes in the destination. Some processor implementations may issue multiple loads to access the appropriate 32/16 bytes. Developers of multi-threaded or multi-processor software should be aware that on these processors the loads will be performed in a non-atomic way.
- If alignment checking is enabled (CR0.AM = 1, RFLAGS.AC = 1, and CPL = 3), an alignment-check exception (#AC) may or may not be generated (depending on processor implementation) when the memory address is not aligned on an 8-byte boundary.

In 64-bit mode, use of the REX.R prefix permits this instruction to access additional registers (XMM8-XMM15).

Note: In VEX-encoded versions, VEX.vvvv is reserved and must be 1111b otherwise instructions will #UD.

### Operation

#### LDDQU (128-bit Legacy SSE version)

DEST[127:0] ← SRC[127:0]

DEST[MAXVL-1:128] (Unmodified)



**VLDDQU (VEX.128 encoded version)**

DEST[127:0] ← SRC[127:0]

DEST[MAXVL-1:128] ← 0

**VLDDQU (VEX.256 encoded version)**

DEST[255:0] ← SRC[255:0]

**Intel C/C++ Compiler Intrinsic Equivalent**LDDQU: `__m128i _mm_lddqu_si128 (__m128i * p);`VLDDQU: `__m256i _mm256_lddqu_si256 (__m256i * p);`**Numeric Exceptions**

None

**Other Exceptions**

See Exceptions Type 4;

Note treatment of #AC varies.

## LDMXCSR—Load MXCSR Register

Opcode/ Instruction	Op/ En	64/32-bit Mode	CPUID Feature Flag	Description
NP OF AE /2 LDMXCSR <i>m32</i>	M	V/V	SSE	Load MXCSR register from <i>m32</i> .
VEX.LZ.OF.WIG AE /2 VLDMXCSR <i>m32</i>	M	V/V	AVX	Load MXCSR register from <i>m32</i> .

### Instruction Operand Encoding

Op/En	Operand 1	Operand 2	Operand 3	Operand 4
M	ModRM:r/m (r)	NA	NA	NA

### Description

Loads the source operand into the MXCSR control/status register. The source operand is a 32-bit memory location. See “MXCSR Control and Status Register” in Chapter 10, of the *Intel® 64 and IA-32 Architectures Software Developer’s Manual, Volume 1*, for a description of the MXCSR register and its contents.

The LDMXCSR instruction is typically used in conjunction with the (V)STMXCSR instruction, which stores the contents of the MXCSR register in memory.

The default MXCSR value at reset is 1F80H.

If a (V)LDMXCSR instruction clears a SIMD floating-point exception mask bit and sets the corresponding exception flag bit, a SIMD floating-point exception will not be immediately generated. The exception will be generated only upon the execution of the next instruction that meets both conditions below:

- the instruction must operate on an XMM or YMM register operand,
- the instruction causes that particular SIMD floating-point exception to be reported.

This instruction’s operation is the same in non-64-bit modes and 64-bit mode.

If VLDMXCSR is encoded with VEX.L= 1, an attempt to execute the instruction encoded with VEX.L= 1 will cause an #UD exception.

Note: In VEX-encoded versions, VEX.vvvv is reserved and must be 1111b, otherwise instructions will #UD.

### Operation

$MXCSR \leftarrow m32;$

### C/C++ Compiler Intrinsic Equivalent

`_mm_setcsr(unsigned int i)`

### Numeric Exceptions

None

### Other Exceptions

See Exceptions Type 5; additionally

#GP For an attempt to set reserved bits in MXCSR.

#UD If VEX.vvvv ≠ 1111B.

## LDS/LES/LFS/LGS/LSS—Load Far Pointer

Opcode	Instruction	Op/En	64-Bit Mode	Compat/Leg Mode	Description
C5 /r	LDS r16,m16:16	RM	Invalid	Valid	Load DS:r16 with far pointer from memory.
C5 /r	LDS r32,m16:32	RM	Invalid	Valid	Load DS:r32 with far pointer from memory.
OF B2 /r	LSS r16,m16:16	RM	Valid	Valid	Load SS:r16 with far pointer from memory.
OF B2 /r	LSS r32,m16:32	RM	Valid	Valid	Load SS:r32 with far pointer from memory.
REX + OF B2 /r	LSS r64,m16:64	RM	Valid	N.E.	Load SS:r64 with far pointer from memory.
C4 /r	LES r16,m16:16	RM	Invalid	Valid	Load ES:r16 with far pointer from memory.
C4 /r	LES r32,m16:32	RM	Invalid	Valid	Load ES:r32 with far pointer from memory.
OF B4 /r	LFS r16,m16:16	RM	Valid	Valid	Load FS:r16 with far pointer from memory.
OF B4 /r	LFS r32,m16:32	RM	Valid	Valid	Load FS:r32 with far pointer from memory.
REX + OF B4 /r	LFS r64,m16:64	RM	Valid	N.E.	Load FS:r64 with far pointer from memory.
OF B5 /r	LGS r16,m16:16	RM	Valid	Valid	Load GS:r16 with far pointer from memory.
OF B5 /r	LGS r32,m16:32	RM	Valid	Valid	Load GS:r32 with far pointer from memory.
REX + OF B5 /r	LGS r64,m16:64	RM	Valid	N.E.	Load GS:r64 with far pointer from memory.

### Instruction Operand Encoding

Op/En	Operand 1	Operand 2	Operand 3	Operand 4
RM	ModRM:reg (w)	ModRM:r/m (r)	NA	NA

### Description

Loads a far pointer (segment selector and offset) from the second operand (source operand) into a segment register and the first operand (destination operand). The source operand specifies a 48-bit or a 32-bit pointer in memory depending on the current setting of the operand-size attribute (32 bits or 16 bits, respectively). The instruction opcode and the destination operand specify a segment register/general-purpose register pair. The 16-bit segment selector from the source operand is loaded into the segment register specified with the opcode (DS, SS, ES, FS, or GS). The 32-bit or 16-bit offset is loaded into the register specified with the destination operand.

If one of these instructions is executed in protected mode, additional information from the segment descriptor pointed to by the segment selector in the source operand is loaded in the hidden part of the selected segment register.

Also in protected mode, a NULL selector (values 0000 through 0003) can be loaded into DS, ES, FS, or GS registers without causing a protection exception. (Any subsequent reference to a segment whose corresponding segment register is loaded with a NULL selector, causes a general-protection exception (#GP) and no memory reference to the segment occurs.)

In 64-bit mode, the instruction's default operation size is 32 bits. Using a REX prefix in the form of REX.W promotes operation to specify a source operand referencing an 80-bit pointer (16-bit selector, 64-bit offset) in memory. Using a REX prefix in the form of REX.R permits access to additional registers (R8-R15). See the summary chart at the beginning of this section for encoding data and limits.

### Operation

64-BIT\_MODE

IF SS is loaded

THEN

IF SegmentSelector = NULL and ( (RPL = 3) or  
(RPL ≠ 3 and RPL ≠ CPL) )

THEN #GP(0);

ELSE IF descriptor is in non-canonical space

```

        THEN #GP(0); FI;
    ELSE IF Segment selector index is not within descriptor table limits
        or segment selector RPL ≠ CPL
        or access rights indicate nonwritable data segment
        or DPL ≠ CPL
        THEN #GP(selector); FI;
    ELSE IF Segment marked not present
        THEN #SS(selector); FI;
    FI;
    SS ← SegmentSelector(SRC);
    SS ← SegmentDescriptor([SRC]);
ELSE IF attempt to load DS, or ES
    THEN #UD;
ELSE IF FS, or GS is loaded with non-NULL segment selector
    THEN IF Segment selector index is not within descriptor table limits
        or access rights indicate segment neither data nor readable code segment
        or segment is data or nonconforming-code segment
        and ( RPL > DPL or CPL > DPL)
        THEN #GP(selector); FI;
    ELSE IF Segment marked not present
        THEN #NP(selector); FI;
    FI;
    SegmentRegister ← SegmentSelector(SRC);
    SegmentRegister ← SegmentDescriptor([SRC]);
    FI;
ELSE IF FS, or GS is loaded with a NULL selector:
    THEN
        SegmentRegister ← NULLSelector;
        SegmentRegister(DescriptorValidBit) ← 0; FI; (* Hidden flag;
            not accessible by software *)
    FI;
DEST ← Offset(SRC);

PRETECTED MODE OR COMPATIBILITY MODE;
IF SS is loaded
    THEN
        IF SegementSelector = NULL
            THEN #GP(0);
        ELSE IF Segment selector index is not within descriptor table limits
            or segment selector RPL ≠ CPL
            or access rights indicate nonwritable data segment
            or DPL ≠ CPL
            THEN #GP(selector); FI;
        ELSE IF Segment marked not present
            THEN #SS(selector); FI;
        FI;
        SS ← SegmentSelector(SRC);
        SS ← SegmentDescriptor([SRC]);
    ELSE IF DS, ES, FS, or GS is loaded with non-NULL segment selector
        THEN IF Segment selector index is not within descriptor table limits
            or access rights indicate segment neither data nor readable code segment
            or segment is data or nonconforming-code segment
            and (RPL > DPL or CPL > DPL)
            THEN #GP(selector); FI;

```

```

    ELSE IF Segment marked not present
        THEN #NP(selector); FI;
    FI;
    SegmentRegister ← SegmentSelector(SRC) AND RPL;
    SegmentRegister ← SegmentDescriptor([SRC]);
    FI;
ELSE IF DS, ES, FS, or GS is loaded with a NULL selector:
    THEN
        SegmentRegister ← NULLSelector;
        SegmentRegister(DescriptorValidBit) ← 0; FI; (* Hidden flag;
            not accessible by software *)
    FI;
DEST ← Offset(SRC);

Real-Address or Virtual-8086 Mode
    SegmentRegister ← SegmentSelector(SRC); FI;
    DEST ← Offset(SRC);

```

### Flags Affected

None

### Protected Mode Exceptions

#UD	If source operand is not a memory location. If the LOCK prefix is used.
#GP(0)	If a NULL selector is loaded into the SS register. If a memory operand effective address is outside the CS, DS, ES, FS, or GS segment limit. If the DS, ES, FS, or GS register is used to access memory and it contains a NULL segment selector.
#GP(selector)	If the SS register is being loaded and any of the following is true: the segment selector index is not within the descriptor table limits, the segment selector RPL is not equal to CPL, the segment is a non-writable data segment, or DPL is not equal to CPL. If the DS, ES, FS, or GS register is being loaded with a non-NULL segment selector and any of the following is true: the segment selector index is not within descriptor table limits, the segment is neither a data nor a readable code segment, or the segment is a data or nonconforming-code segment and both RPL and CPL are greater than DPL.
#SS(0)	If a memory operand effective address is outside the SS segment limit.
#SS(selector)	If the SS register is being loaded and the segment is marked not present.
#NP(selector)	If DS, ES, FS, or GS register is being loaded with a non-NULL segment selector and the segment is marked not present.
#PF(fault-code)	If a page fault occurs.
#AC(0)	If alignment checking is enabled and an unaligned memory reference is made while the current privilege level is 3.

### Real-Address Mode Exceptions

#GP	If a memory operand effective address is outside the CS, DS, ES, FS, or GS segment limit.
#SS	If a memory operand effective address is outside the SS segment limit.
#UD	If source operand is not a memory location. If the LOCK prefix is used.

**Virtual-8086 Mode Exceptions**

#UD	If source operand is not a memory location. If the LOCK prefix is used.
#GP(0)	If a memory operand effective address is outside the CS, DS, ES, FS, or GS segment limit.
#SS(0)	If a memory operand effective address is outside the SS segment limit.
#PF(fault-code)	If a page fault occurs.
#AC(0)	If alignment checking is enabled and an unaligned memory reference is made.

**Compatibility Mode Exceptions**

Same exceptions as in protected mode.

**64-Bit Mode Exceptions**

#GP(0)	If the memory address is in a non-canonical form. If a NULL selector is attempted to be loaded into the SS register in compatibility mode. If a NULL selector is attempted to be loaded into the SS register in CPL3 and 64-bit mode. If a NULL selector is attempted to be loaded into the SS register in non-CPL3 and 64-bit mode where its RPL is not equal to CPL.
#GP(Selector)	If the FS, or GS register is being loaded with a non-NULL segment selector and any of the following is true: the segment selector index is not within descriptor table limits, the memory address of the descriptor is non-canonical, the segment is neither a data nor a readable code segment, or the segment is a data or nonconforming-code segment and both RPL and CPL are greater than DPL. If the SS register is being loaded and any of the following is true: the segment selector index is not within the descriptor table limits, the memory address of the descriptor is non-canonical, the segment selector RPL is not equal to CPL, the segment is a nonwritable data segment, or DPL is not equal to CPL.
#SS(0)	If a memory operand effective address is non-canonical
#SS(Selector)	If the SS register is being loaded and the segment is marked not present.
#NP(selector)	If FS, or GS register is being loaded with a non-NULL segment selector and the segment is marked not present.
#PF(fault-code)	If a page fault occurs.
#AC(0)	If alignment checking is enabled and an unaligned memory reference is made while the current privilege level is 3.
#UD	If source operand is not a memory location. If the LOCK prefix is used.

## LEA—Load Effective Address

Opcode	Instruction	Op/En	64-Bit Mode	Compat/Leg Mode	Description
8D /r	LEA r16,m	RM	Valid	Valid	Store effective address for <i>m</i> in register <i>r16</i> .
8D /r	LEA r32,m	RM	Valid	Valid	Store effective address for <i>m</i> in register <i>r32</i> .
REX.W + 8D /r	LEA r64,m	RM	Valid	N.E.	Store effective address for <i>m</i> in register <i>r64</i> .

### Instruction Operand Encoding

Op/En	Operand 1	Operand 2	Operand 3	Operand 4
RM	ModRM:reg ( <i>w</i> )	ModRM:r/m ( <i>r</i> )	NA	NA

### Description

Computes the effective address of the second operand (the source operand) and stores it in the first operand (destination operand). The source operand is a memory address (offset part) specified with one of the processors addressing modes; the destination operand is a general-purpose register. The address-size and operand-size attributes affect the action performed by this instruction, as shown in the following table. The operand-size attribute of the instruction is determined by the chosen register; the address-size attribute is determined by the attribute of the code segment.

**Table 3-53. Non-64-bit Mode LEA Operation with Address and Operand Size Attributes**

Operand Size	Address Size	Action Performed
16	16	16-bit effective address is calculated and stored in requested 16-bit register destination.
16	32	32-bit effective address is calculated. The lower 16 bits of the address are stored in the requested 16-bit register destination.
32	16	16-bit effective address is calculated. The 16-bit address is zero-extended and stored in the requested 32-bit register destination.
32	32	32-bit effective address is calculated and stored in the requested 32-bit register destination.

Different assemblers may use different algorithms based on the size attribute and symbolic reference of the source operand.

In 64-bit mode, the instruction's destination operand is governed by operand size attribute, the default operand size is 32 bits. Address calculation is governed by address size attribute, the default address size is 64-bits. In 64-bit mode, address size of 16 bits is not encodable. See Table 3-54.

**Table 3-54. 64-bit Mode LEA Operation with Address and Operand Size Attributes**

Operand Size	Address Size	Action Performed
16	32	32-bit effective address is calculated (using 67H prefix). The lower 16 bits of the address are stored in the requested 16-bit register destination (using 66H prefix).
16	64	64-bit effective address is calculated (default address size). The lower 16 bits of the address are stored in the requested 16-bit register destination (using 66H prefix).
32	32	32-bit effective address is calculated (using 67H prefix) and stored in the requested 32-bit register destination.
32	64	64-bit effective address is calculated (default address size) and the lower 32 bits of the address are stored in the requested 32-bit register destination.
64	32	32-bit effective address is calculated (using 67H prefix), zero-extended to 64-bits, and stored in the requested 64-bit register destination (using REX.W).
64	64	64-bit effective address is calculated (default address size) and all 64-bits of the address are stored in the requested 64-bit register destination (using REX.W).

**Operation**

```

IF OperandSize = 16 and AddressSize = 16
  THEN
    DEST ← EffectiveAddress(SRC); (* 16-bit address *)
  ELSE IF OperandSize = 16 and AddressSize = 32
    THEN
      temp ← EffectiveAddress(SRC); (* 32-bit address *)
      DEST ← temp[0:15]; (* 16-bit address *)
    FI;
  ELSE IF OperandSize = 32 and AddressSize = 16
    THEN
      temp ← EffectiveAddress(SRC); (* 16-bit address *)
      DEST ← ZeroExtend(temp); (* 32-bit address *)
    FI;
  ELSE IF OperandSize = 32 and AddressSize = 32
    THEN
      DEST ← EffectiveAddress(SRC); (* 32-bit address *)
    FI;
  ELSE IF OperandSize = 16 and AddressSize = 64
    THEN
      temp ← EffectiveAddress(SRC); (* 64-bit address *)
      DEST ← temp[0:15]; (* 16-bit address *)
    FI;
  ELSE IF OperandSize = 32 and AddressSize = 64
    THEN
      temp ← EffectiveAddress(SRC); (* 64-bit address *)
      DEST ← temp[0:31]; (* 16-bit address *)
    FI;
  ELSE IF OperandSize = 64 and AddressSize = 64
    THEN
      DEST ← EffectiveAddress(SRC); (* 64-bit address *)
    FI;
FI;

```

**Flags Affected**

None

**Protected Mode Exceptions**

#UD                    If source operand is not a memory location.  
                           If the LOCK prefix is used.

**Real-Address Mode Exceptions**

Same exceptions as in protected mode.

**Virtual-8086 Mode Exceptions**

Same exceptions as in protected mode.

**Compatibility Mode Exceptions**

Same exceptions as in protected mode.

**64-Bit Mode Exceptions**

Same exceptions as in protected mode.



## LEAVE—High Level Procedure Exit

Opcode	Instruction	Op/En	64-Bit Mode	Compat/Leg Mode	Description
C9	LEAVE	Z0	Valid	Valid	Set SP to BP, then pop BP.
C9	LEAVE	Z0	N.E.	Valid	Set ESP to EBP, then pop EBP.
C9	LEAVE	Z0	Valid	N.E.	Set RSP to RBP, then pop RBP.

### Instruction Operand Encoding

Op/En	Operand 1	Operand 2	Operand 3	Operand 4
Z0	NA	NA	NA	NA

### Description

Releases the stack frame set up by an earlier ENTER instruction. The LEAVE instruction copies the frame pointer (in the EBP register) into the stack pointer register (ESP), which releases the stack space allocated to the stack frame. The old frame pointer (the frame pointer for the calling procedure that was saved by the ENTER instruction) is then popped from the stack into the EBP register, restoring the calling procedure's stack frame.

A RET instruction is commonly executed following a LEAVE instruction to return program control to the calling procedure.

See "Procedure Calls for Block-Structured Languages" in Chapter 7 of the *Intel® 64 and IA-32 Architectures Software Developer's Manual, Volume 1*, for detailed information on the use of the ENTER and LEAVE instructions.

In 64-bit mode, the instruction's default operation size is 64 bits; 32-bit operation cannot be encoded. See the summary chart at the beginning of this section for encoding data and limits.

### Operation

```
IF StackAddressSize = 32
  THEN
    ESP ← EBP;
  ELSE IF StackAddressSize = 64
    THEN RSP ← RBP; FI;
  ELSE IF StackAddressSize = 16
    THEN SP ← BP; FI;
FI;
```

```
IF OperandSize = 32
  THEN EBP ← Pop();
  ELSE IF OperandSize = 64
    THEN RBP ← Pop(); FI;
  ELSE IF OperandSize = 16
    THEN BP ← Pop(); FI;
FI;
```

### Flags Affected

None

### Protected Mode Exceptions

- #SS(0) If the EBP register points to a location that is not within the limits of the current stack segment.
- #PF(fault-code) If a page fault occurs.
- #AC(0) If alignment checking is enabled and an unaligned memory reference is made while the current privilege level is 3.
- #UD If the LOCK prefix is used.

### Real-Address Mode Exceptions

- #GP If the EBP register points to a location outside of the effective address space from 0 to FFFFH.
- #UD If the LOCK prefix is used.

### Virtual-8086 Mode Exceptions

- #GP(0) If the EBP register points to a location outside of the effective address space from 0 to FFFFH.
- #PF(fault-code) If a page fault occurs.
- #AC(0) If alignment checking is enabled and an unaligned memory reference is made.
- #UD If the LOCK prefix is used.

### Compatibility Mode Exceptions

Same exceptions as in protected mode.

### 64-Bit Mode Exceptions

- #SS(0) If the stack address is in a non-canonical form.
- #AC(0) If alignment checking is enabled and an unaligned memory reference is made while the current privilege level is 3.
- #UD If the LOCK prefix is used.

## LFENCE—Load Fence

Opcode	Instruction	Op/En	64-Bit Mode	Compat/Leg Mode	Description
NP 0F AE E8	LFENCE	Z0	Valid	Valid	Serializes load operations.

### Instruction Operand Encoding

Op/En	Operand 1	Operand 2	Operand 3	Operand 4
Z0	NA	NA	NA	NA

### Description

Performs a serializing operation on all load-from-memory instructions that were issued prior the LFENCE instruction. Specifically, LFENCE does not execute until all prior instructions have completed locally, and no later instruction begins execution until LFENCE completes. In particular, an instruction that loads from memory and that precedes an LFENCE receives data from memory prior to completion of the LFENCE. (An LFENCE that follows an instruction that stores to memory might complete before the data being stored have become globally visible.) Instructions following an LFENCE may be fetched from memory before the LFENCE, but they will not execute until the LFENCE completes.

Weakly ordered memory types can be used to achieve higher processor performance through such techniques as out-of-order issue and speculative reads. The degree to which a consumer of data recognizes or knows that the data is weakly ordered varies among applications and may be unknown to the producer of this data. The LFENCE instruction provides a performance-efficient way of ensuring load ordering between routines that produce weakly-ordered results and routines that consume that data.

Processors are free to fetch and cache data speculatively from regions of system memory that use the WB, WC, and WT memory types. This speculative fetching can occur at any time and is not tied to instruction execution. Thus, it is not ordered with respect to executions of the LFENCE instruction; data can be brought into the caches speculatively just before, during, or after the execution of an LFENCE instruction.

This instruction's operation is the same in non-64-bit modes and 64-bit mode.

Specification of the instruction's opcode above indicates a ModR/M byte of E8. For this instruction, the processor ignores the r/m field of the ModR/M byte. Thus, LFENCE is encoded by any opcode of the form 0F AE Ex, where x is in the range 8-F.

### Operation

```
Wait_On_Following_Instructions_Until(preceding_instructions_complete);
```

### Intel C/C++ Compiler Intrinsic Equivalent

```
void _mm_lfence(void)
```

### Exceptions (All Modes of Operation)

#UD                    If CPUID.01H:EDX.SSE2[bit 26] = 0.  
                          If the LOCK prefix is used.

**LGDT/LIDT—Load Global/Interrupt Descriptor Table Register**

Opcode	Instruction	Op/En	64-Bit Mode	Compat/Leg Mode	Description
OF 01 /2	LGDT <i>m16&amp;32</i>	M	N.E.	Valid	Load <i>m</i> into GDTR.
OF 01 /3	LIDT <i>m16&amp;32</i>	M	N.E.	Valid	Load <i>m</i> into IDTR.
OF 01 /2	LGDT <i>m16&amp;64</i>	M	Valid	N.E.	Load <i>m</i> into GDTR.
OF 01 /3	LIDT <i>m16&amp;64</i>	M	Valid	N.E.	Load <i>m</i> into IDTR.

**Instruction Operand Encoding**

Op/En	Operand 1	Operand 2	Operand 3	Operand 4
M	ModRM:r/m (r)	NA	NA	NA

**Description**

Loads the values in the source operand into the global descriptor table register (GDTR) or the interrupt descriptor table register (IDTR). The source operand specifies a 6-byte memory location that contains the base address (a linear address) and the limit (size of table in bytes) of the global descriptor table (GDT) or the interrupt descriptor table (IDT). If operand-size attribute is 32 bits, a 16-bit limit (lower 2 bytes of the 6-byte data operand) and a 32-bit base address (upper 4 bytes of the data operand) are loaded into the register. If the operand-size attribute is 16 bits, a 16-bit limit (lower 2 bytes) and a 24-bit base address (third, fourth, and fifth byte) are loaded. Here, the high-order byte of the operand is not used and the high-order byte of the base address in the GDTR or IDTR is filled with zeros.

The LGDT and LIDT instructions are used only in operating-system software; they are not used in application programs. They are the only instructions that directly load a linear address (that is, not a segment-relative address) and a limit in protected mode. They are commonly executed in real-address mode to allow processor initialization prior to switching to protected mode.

In 64-bit mode, the instruction's operand size is fixed at 8+2 bytes (an 8-byte base and a 2-byte limit). See the summary chart at the beginning of this section for encoding data and limits.

See "SGDT—Store Global Descriptor Table Register" in Chapter 4, *Intel® 64 and IA-32 Architectures Software Developer's Manual, Volume 2B*, for information on storing the contents of the GDTR and IDTR.

## Operation

```

IF Instruction is LIDT
  THEN
    IF OperandSize = 16
      THEN
        IDTR(Limit) ← SRC[0:15];
        IDTR(Base) ← SRC[16:47] AND 00FFFFFFH;
      ELSE IF 32-bit Operand Size
        THEN
          IDTR(Limit) ← SRC[0:15];
          IDTR(Base) ← SRC[16:47];
        FI;
      ELSE IF 64-bit Operand Size (* In 64-Bit Mode *)
        THEN
          IDTR(Limit) ← SRC[0:15];
          IDTR(Base) ← SRC[16:79];
        FI;
      FI;
    ELSE (* Instruction is LGDT *)
      IF OperandSize = 16
        THEN
          GDTR(Limit) ← SRC[0:15];
          GDTR(Base) ← SRC[16:47] AND 00FFFFFFH;
        ELSE IF 32-bit Operand Size
          THEN
            GDTR(Limit) ← SRC[0:15];
            GDTR(Base) ← SRC[16:47];
          FI;
        ELSE IF 64-bit Operand Size (* In 64-Bit Mode *)
          THEN
            GDTR(Limit) ← SRC[0:15];
            GDTR(Base) ← SRC[16:79];
          FI;
        FI;
      FI;
    FI;
  FI;

```

## Flags Affected

None

## Protected Mode Exceptions

#UD	If the LOCK prefix is used.
#GP(0)	If the current privilege level is not 0. If a memory operand effective address is outside the CS, DS, ES, FS, or GS segment limit. If the DS, ES, FS, or GS register is used to access memory and it contains a NULL segment selector.
#SS(0)	If a memory operand effective address is outside the SS segment limit.
#PF(fault-code)	If a page fault occurs.

### Real-Address Mode Exceptions

- #UD If the LOCK prefix is used.
- #GP If a memory operand effective address is outside the CS, DS, ES, FS, or GS segment limit.
- #SS If a memory operand effective address is outside the SS segment limit.

### Virtual-8086 Mode Exceptions

- #UD If the LOCK prefix is used.
- #GP If the current privilege level is not 0.

### Compatibility Mode Exceptions

Same exceptions as in protected mode.

### 64-Bit Mode Exceptions

- #SS(0) If a memory address referencing the SS segment is in a non-canonical form.
- #GP(0) If the current privilege level is not 0.  
If the memory address is in a non-canonical form.
- #UD If the LOCK prefix is used.
- #PF(fault-code) If a page fault occurs.

## LLDT—Load Local Descriptor Table Register

Opcode	Instruction	Op/En	64-Bit Mode	Compat/Leg Mode	Description
OF 00 /2	LLDT <i>r/m16</i>	M	Valid	Valid	Load segment selector <i>r/m16</i> into LDTR.

### Instruction Operand Encoding

Op/En	Operand 1	Operand 2	Operand 3	Operand 4
M	ModRM: <i>r/m</i> ( <i>r</i> )	NA	NA	NA

### Description

Loads the source operand into the segment selector field of the local descriptor table register (LDTR). The source operand (a general-purpose register or a memory location) contains a segment selector that points to a local descriptor table (LDT). After the segment selector is loaded in the LDTR, the processor uses the segment selector to locate the segment descriptor for the LDT in the global descriptor table (GDT). It then loads the segment limit and base address for the LDT from the segment descriptor into the LDTR. The segment registers DS, ES, SS, FS, GS, and CS are not affected by this instruction, nor is the LDTR field in the task state segment (TSS) for the current task.

If bits 2-15 of the source operand are 0, LDTR is marked invalid and the LLDT instruction completes silently. However, all subsequent references to descriptors in the LDT (except by the LAR, VERR, VERW or LSL instructions) cause a general protection exception (#GP).

The operand-size attribute has no effect on this instruction.

The LLDT instruction is provided for use in operating-system software; it should not be used in application programs. This instruction can only be executed in protected mode or 64-bit mode.

In 64-bit mode, the operand size is fixed at 16 bits.

### Operation

```
IF SRC(Offset) > descriptor table limit
  THEN #GP(segment selector); FI;
```

```
IF segment selector is valid
```

```
  Read segment descriptor;
```

```
  IF SegmentDescriptor(Type) ≠ LDT
    THEN #GP(segment selector); FI;
```

```
  IF segment descriptor is not present
    THEN #NP(segment selector); FI;
```

```
  LDTR(SegmentSelector) ← SRC;
```

```
  LDTR(SegmentDescriptor) ← GDTSegmentDescriptor;
```

```
ELSE LDTR ← INVALID
```

```
FI;
```

### Flags Affected

None

**Protected Mode Exceptions**

#GP(0)	If the current privilege level is not 0. If a memory operand effective address is outside the CS, DS, ES, FS, or GS segment limit. If the DS, ES, FS, or GS register contains a NULL segment selector.
#GP(selector)	If the selector operand does not point into the Global Descriptor Table or if the entry in the GDT is not a Local Descriptor Table. Segment selector is beyond GDT limit.
#SS(0)	If a memory operand effective address is outside the SS segment limit.
#NP(selector)	If the LDT descriptor is not present.
#PF(fault-code)	If a page fault occurs.
#UD	If the LOCK prefix is used.

**Real-Address Mode Exceptions**

#UD	The LLDT instruction is not recognized in real-address mode.
-----	--

**Virtual-8086 Mode Exceptions**

#UD	The LLDT instruction is not recognized in virtual-8086 mode.
-----	--

**Compatibility Mode Exceptions**

Same exceptions as in protected mode.

**64-Bit Mode Exceptions**

#SS(0)	If a memory address referencing the SS segment is in a non-canonical form.
#GP(0)	If the current privilege level is not 0. If the memory address is in a non-canonical form.
#GP(selector)	If the selector operand does not point into the Global Descriptor Table or if the entry in the GDT is not a Local Descriptor Table. Segment selector is beyond GDT limit.
#NP(selector)	If the LDT descriptor is not present.
#PF(fault-code)	If a page fault occurs.
#UD	If the LOCK prefix is used.



## LMSW—Load Machine Status Word

Opcode	Instruction	Op/En	64-Bit Mode	Compat/Leg Mode	Description
OF 01 /6	LMSW <i>r/m16</i>	M	Valid	Valid	Loads <i>r/m16</i> in machine status word of CR0.

### Instruction Operand Encoding

Op/En	Operand 1	Operand 2	Operand 3	Operand 4
M	ModRM: <i>r/m</i> ( <i>r</i> )	NA	NA	NA

### Description

Loads the source operand into the machine status word, bits 0 through 15 of register CR0. The source operand can be a 16-bit general-purpose register or a memory location. Only the low-order 4 bits of the source operand (which contains the PE, MP, EM, and TS flags) are loaded into CR0. The PG, CD, NW, AM, WP, NE, and ET flags of CR0 are not affected. The operand-size attribute has no effect on this instruction.

If the PE flag of the source operand (bit 0) is set to 1, the instruction causes the processor to switch to protected mode. While in protected mode, the LMSW instruction cannot be used to clear the PE flag and force a switch back to real-address mode.

The LMSW instruction is provided for use in operating-system software; it should not be used in application programs. In protected or virtual-8086 mode, it can only be executed at CPL 0.

This instruction is provided for compatibility with the Intel 286 processor; programs and procedures intended to run on IA-32 and Intel 64 processors beginning with Intel386 processors should use the MOV (control registers) instruction to load the whole CR0 register. The MOV CR0 instruction can be used to set and clear the PE flag in CR0, allowing a procedure or program to switch between protected and real-address modes.

This instruction is a serializing instruction.

This instruction's operation is the same in non-64-bit modes and 64-bit mode. Note that the operand size is fixed at 16 bits.

See "Changes to Instruction Behavior in VMX Non-Root Operation" in Chapter 25 of the *Intel® 64 and IA-32 Architectures Software Developer's Manual, Volume 3C*, for more information about the behavior of this instruction in VMX non-root operation.

### Operation

CR0[0:3] ← SRC[0:3];

### Flags Affected

None

### Protected Mode Exceptions

- #GP(0) If the current privilege level is not 0.  
If a memory operand effective address is outside the CS, DS, ES, FS, or GS segment limit.  
If the DS, ES, FS, or GS register is used to access memory and it contains a NULL segment selector.
- #SS(0) If a memory operand effective address is outside the SS segment limit.
- #PF(fault-code) If a page fault occurs.
- #UD If the LOCK prefix is used.

### Real-Address Mode Exceptions

- #GP If a memory operand effective address is outside the CS, DS, ES, FS, or GS segment limit.
- #UD If the LOCK prefix is used.

### Virtual-8086 Mode Exceptions

- #GP(0) The LMSW instruction is not recognized in virtual-8086 mode.
- #UD If the LOCK prefix is used.

### Compatibility Mode Exceptions

Same exceptions as in protected mode.

### 64-Bit Mode Exceptions

- #SS(0) If a memory address referencing the SS segment is in a non-canonical form.
- #GP(0) If the current privilege level is not 0.  
If the memory address is in a non-canonical form.
- #PF(fault-code) If a page fault occurs.
- #UD If the LOCK prefix is used.

## LOCK—Assert LOCK# Signal Prefix

Opcode	Instruction	Op/En	64-Bit Mode	Compat/Leg Mode	Description
F0	LOCK	Z0	Valid	Valid	Asserts LOCK# signal for duration of the accompanying instruction.

### NOTES:

\* See IA-32 Architecture Compatibility section below.

### Instruction Operand Encoding

Op/En	Operand 1	Operand 2	Operand 3	Operand 4
Z0	NA	NA	NA	NA

### Description

Causes the processor's LOCK# signal to be asserted during execution of the accompanying instruction (turns the instruction into an atomic instruction). In a multiprocessor environment, the LOCK# signal ensures that the processor has exclusive use of any shared memory while the signal is asserted.

In most IA-32 and all Intel 64 processors, locking may occur without the LOCK# signal being asserted. See the "IA-32 Architecture Compatibility" section below for more details.

The LOCK prefix can be prepended only to the following instructions and only to those forms of the instructions where the destination operand is a memory operand: ADD, ADC, AND, BTC, BTR, BTS, CMPXCHG, CMPXCH8B, CMPXCHG16B, DEC, INC, NEG, NOT, OR, SBB, SUB, XOR, XADD, and XCHG. If the LOCK prefix is used with one of these instructions and the source operand is a memory operand, an undefined opcode exception (#UD) may be generated. An undefined opcode exception will also be generated if the LOCK prefix is used with any instruction not in the above list. The XCHG instruction always asserts the LOCK# signal regardless of the presence or absence of the LOCK prefix.

The LOCK prefix is typically used with the BTS instruction to perform a read-modify-write operation on a memory location in shared memory environment.

The integrity of the LOCK prefix is not affected by the alignment of the memory field. Memory locking is observed for arbitrarily misaligned fields.

This instruction's operation is the same in non-64-bit modes and 64-bit mode.

### IA-32 Architecture Compatibility

Beginning with the P6 family processors, when the LOCK prefix is prefixed to an instruction and the memory area being accessed is cached internally in the processor, the LOCK# signal is generally not asserted. Instead, only the processor's cache is locked. Here, the processor's cache coherency mechanism ensures that the operation is carried out atomically with regards to memory. See "Effects of a Locked Operation on Internal Processor Caches" in Chapter 8 of *Intel® 64 and IA-32 Architectures Software Developer's Manual, Volume 3A*, for more information on locking of caches.

### Operation

AssertLOCK#(DurationOfAccompanyingInstruction);

### Flags Affected

None

### Protected Mode Exceptions

#UD If the LOCK prefix is used with an instruction not listed: ADD, ADC, AND, BTC, BTR, BTS, CMPXCHG, CMPXCH8B, CMPXCHG16B, DEC, INC, NEG, NOT, OR, SBB, SUB, XOR, XADD, XCHG.

Other exceptions can be generated by the instruction when the LOCK prefix is applied.

**Real-Address Mode Exceptions**

Same exceptions as in protected mode.

**Virtual-8086 Mode Exceptions**

Same exceptions as in protected mode.

**Compatibility Mode Exceptions**

Same exceptions as in protected mode.

**64-Bit Mode Exceptions**

Same exceptions as in protected mode.

## LODS/LODSB/LODSW/LODSD/LODSQ—Load String

Opcode	Instruction	Op/En	64-Bit Mode	Compat/Leg Mode	Description
AC	LODS <i>m8</i>	Z0	Valid	Valid	For legacy mode, Load byte at address DS:(E)SI into AL. For 64-bit mode load byte at address (R)SI into AL.
AD	LODS <i>m16</i>	Z0	Valid	Valid	For legacy mode, Load word at address DS:(E)SI into AX. For 64-bit mode load word at address (R)SI into AX.
AD	LODS <i>m32</i>	Z0	Valid	Valid	For legacy mode, Load dword at address DS:(E)SI into EAX. For 64-bit mode load dword at address (R)SI into EAX.
REX.W + AD	LODS <i>m64</i>	Z0	Valid	N.E.	Load qword at address (R)SI into RAX.
AC	LODSB	Z0	Valid	Valid	For legacy mode, Load byte at address DS:(E)SI into AL. For 64-bit mode load byte at address (R)SI into AL.
AD	LODSW	Z0	Valid	Valid	For legacy mode, Load word at address DS:(E)SI into AX. For 64-bit mode load word at address (R)SI into AX.
AD	LODSD	Z0	Valid	Valid	For legacy mode, Load dword at address DS:(E)SI into EAX. For 64-bit mode load dword at address (R)SI into EAX.
REX.W + AD	LODSQ	Z0	Valid	N.E.	Load qword at address (R)SI into RAX.

### Instruction Operand Encoding

Op/En	Operand 1	Operand 2	Operand 3	Operand 4
Z0	NA	NA	NA	NA

### Description

Loads a byte, word, or doubleword from the source operand into the AL, AX, or EAX register, respectively. The source operand is a memory location, the address of which is read from the DS:ESI or the DS:SI registers (depending on the address-size attribute of the instruction, 32 or 16, respectively). The DS segment may be overridden with a segment override prefix.

At the assembly-code level, two forms of this instruction are allowed: the “explicit-operands” form and the “no-operands” form. The explicit-operands form (specified with the LODS mnemonic) allows the source operand to be specified explicitly. Here, the source operand should be a symbol that indicates the size and location of the source value. The destination operand is then automatically selected to match the size of the source operand (the AL register for byte operands, AX for word operands, and EAX for doubleword operands). This explicit-operands form is provided to allow documentation; however, note that the documentation provided by this form can be misleading. That is, the source operand symbol must specify the correct **type** (size) of the operand (byte, word, or doubleword), but it does not have to specify the correct **location**. The location is always specified by the DS:(E)SI registers, which must be loaded correctly before the load string instruction is executed.

The no-operands form provides “short forms” of the byte, word, and doubleword versions of the LODS instructions. Here also DS:(E)SI is assumed to be the source operand and the AL, AX, or EAX register is assumed to be the destination operand. The size of the source and destination operands is selected with the mnemonic: LODSB (byte loaded into register AL), LODSW (word loaded into AX), or LODSD (doubleword loaded into EAX).

After the byte, word, or doubleword is transferred from the memory location into the AL, AX, or EAX register, the (E)SI register is incremented or decremented automatically according to the setting of the DF flag in the EFLAGS register. (If the DF flag is 0, the (E)SI register is incremented; if the DF flag is 1, the ESI register is decremented.) The (E)SI register is incremented or decremented by 1 for byte operations, by 2 for word operations, or by 4 for doubleword operations.

In 64-bit mode, use of the REX.W prefix promotes operation to 64 bits. LODS/LODSQ load the quadword at address (R)SI into RAX. The (R)SI register is then incremented or decremented automatically according to the setting of the DF flag in the EFLAGS register.

The LODS, LODSB, LODSW, and LODSD instructions can be preceded by the REP prefix for block loads of ECX bytes, words, or doublewords. More often, however, these instructions are used within a LOOP construct because further processing of the data moved into the register is usually necessary before the next transfer can be made. See “REP/REPE/REPZ /REPNE/REPZ—Repeat String Operation Prefix” in Chapter 4 of the *Intel® 64 and IA-32 Architectures Software Developer’s Manual, Volume 2B*, for a description of the REP prefix.

## Operation

```

IF AL ← SRC; (* Byte load *)
  THEN AL ← SRC; (* Byte load *)
    IF DF = 0
      THEN (E)SI ← (E)SI + 1;
      ELSE (E)SI ← (E)SI - 1;
    FI;
ELSE IF AX ← SRC; (* Word load *)
  THEN IF DF = 0
    THEN (E)SI ← (E)SI + 2;
    ELSE (E)SI ← (E)SI - 2;
  IF;
  FI;
ELSE IF EAX ← SRC; (* Doubleword load *)
  THEN IF DF = 0
    THEN (E)SI ← (E)SI + 4;
    ELSE (E)SI ← (E)SI - 4;
  FI;
  FI;
ELSE IF RAX ← SRC; (* Quadword load *)
  THEN IF DF = 0
    THEN (R)SI ← (R)SI + 8;
    ELSE (R)SI ← (R)SI - 8;
  FI;
  FI;
FI;

```

## Flags Affected

None

## Protected Mode Exceptions

#GP(0)	If a memory operand effective address is outside the CS, DS, ES, FS, or GS segment limit. If the DS, ES, FS, or GS register contains a NULL segment selector.
#SS(0)	If a memory operand effective address is outside the SS segment limit.
#PF(fault-code)	If a page fault occurs.
#AC(0)	If alignment checking is enabled and an unaligned memory reference is made while the current privilege level is 3.
#UD	If the LOCK prefix is used.

## Real-Address Mode Exceptions

#GP	If a memory operand effective address is outside the CS, DS, ES, FS, or GS segment limit.
#SS	If a memory operand effective address is outside the SS segment limit.
#UD	If the LOCK prefix is used.

### Virtual-8086 Mode Exceptions

#GP(0)	If a memory operand effective address is outside the CS, DS, ES, FS, or GS segment limit.
#SS(0)	If a memory operand effective address is outside the SS segment limit.
#PF(fault-code)	If a page fault occurs.
#AC(0)	If alignment checking is enabled and an unaligned memory reference is made.
#UD	If the LOCK prefix is used.

### Compatibility Mode Exceptions

Same exceptions as in protected mode.

### 64-Bit Mode Exceptions

#SS(0)	If a memory address referencing the SS segment is in a non-canonical form.
#GP(0)	If the memory address is in a non-canonical form.
#PF(fault-code)	If a page fault occurs.
#AC(0)	If alignment checking is enabled and an unaligned memory reference is made while the current privilege level is 3.
#UD	If the LOCK prefix is used.

**LOOP/LOOPcc—Loop According to ECX Counter**

Opcode	Instruction	Op/En	64-Bit Mode	Compat/Leg Mode	Description
E2 <i>cb</i>	LOOP <i>rel8</i>	D	Valid	Valid	Decrement count; jump short if count $\neq$ 0.
E1 <i>cb</i>	LOOPE <i>rel8</i>	D	Valid	Valid	Decrement count; jump short if count $\neq$ 0 and ZF = 1.
E0 <i>cb</i>	LOOPNE <i>rel8</i>	D	Valid	Valid	Decrement count; jump short if count $\neq$ 0 and ZF = 0.

**Instruction Operand Encoding**

Op/En	Operand 1	Operand 2	Operand 3	Operand 4
D	Offset	NA	NA	NA

**Description**

Performs a loop operation using the RCX, ECX or CX register as a counter (depending on whether address size is 64 bits, 32 bits, or 16 bits). Note that the LOOP instruction ignores REX.W; but 64-bit address size can be over-ridden using a 67H prefix.

Each time the LOOP instruction is executed, the count register is decremented, then checked for 0. If the count is 0, the loop is terminated and program execution continues with the instruction following the LOOP instruction. If the count is not zero, a near jump is performed to the destination (target) operand, which is presumably the instruction at the beginning of the loop.

The target instruction is specified with a relative offset (a signed offset relative to the current value of the instruction pointer in the IP/EIP/RIP register). This offset is generally specified as a label in assembly code, but at the machine code level, it is encoded as a signed, 8-bit immediate value, which is added to the instruction pointer. Offsets of  $-128$  to  $+127$  are allowed with this instruction.

Some forms of the loop instruction (LOOP $cc$ ) also accept the ZF flag as a condition for terminating the loop before the count reaches zero. With these forms of the instruction, a condition code ( $cc$ ) is associated with each instruction to indicate the condition being tested for. Here, the LOOP $cc$  instruction itself does not affect the state of the ZF flag; the ZF flag is changed by other instructions in the loop.

**Operation**

```
IF (AddressSize = 32)
  THEN Count is ECX;
ELSE IF (AddressSize = 64)
  Count is RCX;
ELSE Count is CX;
FI;
```

```
Count ← Count - 1;
```

```
IF Instruction is not LOOP
  THEN
    IF (Instruction ← LOOPE) or (Instruction ← LOOPZ)
      THEN IF (ZF = 1) and (Count  $\neq$  0)
        THEN BranchCond ← 1;
        ELSE BranchCond ← 0;
      FI;
    ELSE (Instruction = LOOPNE) or (Instruction = LOOPNZ)
      IF (ZF = 0) and (Count  $\neq$  0)
        THEN BranchCond ← 1;
        ELSE BranchCond ← 0;
```



```

        FI;
    FI;
ELSE (* Instruction = LOOP *)
    IF (Count ≠ 0)
        THEN BranchCond ← 1;
        ELSE BranchCond ← 0;
    FI;
FI;

IF BranchCond = 1
    THEN
        IF OperandSize = 32
            THEN EIP ← EIP + SignExtend(DEST);
            ELSE IF OperandSize = 64
                THEN RIP ← RIP + SignExtend(DEST);
                FI;
            ELSE IF OperandSize = 16
                THEN EIP ← EIP AND 0000FFFFH;
                FI;
        FI;
        IF OperandSize = (32 or 64)
            THEN IF (R/E)IP < CS.Base or (R/E)IP > CS.Limit
                #GP; FI;
                FI;
        FI;
    ELSE
        Terminate loop and continue program execution at (R/E)IP;
FI;

```

### Flags Affected

None

### Protected Mode Exceptions

#GP(0)            If the offset being jumped to is beyond the limits of the CS segment.  
#UD                If the LOCK prefix is used.

### Real-Address Mode Exceptions

#GP                If the offset being jumped to is beyond the limits of the CS segment or is outside of the effective address space from 0 to FFFFH. This condition can occur if a 32-bit address size override prefix is used.  
#UD                If the LOCK prefix is used.

### Virtual-8086 Mode Exceptions

Same exceptions as in real address mode.

### Compatibility Mode Exceptions

Same exceptions as in protected mode.

### 64-Bit Mode Exceptions

#GP(0)            If the offset being jumped to is in a non-canonical form.  
#UD                If the LOCK prefix is used.

## LSL—Load Segment Limit

Opcode	Instruction	Op/En	64-Bit Mode	Compat/Leg Mode	Description
OF 03 /r	LSL r16, r16/m16	RM	Valid	Valid	Load: r16 ← segment limit, selector r16/m16.
OF 03 /r	LSL r32, r32/m16*	RM	Valid	Valid	Load: r32 ← segment limit, selector r32/m16.
REX.W + OF 03 /r	LSL r64, r32/m16*	RM	Valid	Valid	Load: r64 ← segment limit, selector r32/m16

### NOTES:

\* For all loads (regardless of destination sizing), only bits 16-0 are used. Other bits are ignored.

### Instruction Operand Encoding

Op/En	Operand 1	Operand 2	Operand 3	Operand 4
RM	ModRM:reg (w)	ModRM:r/m (r)	NA	NA

### Description

Loads the unscrambled segment limit from the segment descriptor specified with the second operand (source operand) into the first operand (destination operand) and sets the ZF flag in the EFLAGS register. The source operand (which can be a register or a memory location) contains the segment selector for the segment descriptor being accessed. The destination operand is a general-purpose register.

The processor performs access checks as part of the loading process. Once loaded in the destination register, software can compare the segment limit with the offset of a pointer.

The segment limit is a 20-bit value contained in bytes 0 and 1 and in the first 4 bits of byte 6 of the segment descriptor. If the descriptor has a byte granular segment limit (the granularity flag is set to 0), the destination operand is loaded with a byte granular value (byte limit). If the descriptor has a page granular segment limit (the granularity flag is set to 1), the LSL instruction will translate the page granular limit (page limit) into a byte limit before loading it into the destination operand. The translation is performed by shifting the 20-bit “raw” limit left 12 bits and filling the low-order 12 bits with 1s.

When the operand size is 32 bits, the 32-bit byte limit is stored in the destination operand. When the operand size is 16 bits, a valid 32-bit limit is computed; however, the upper 16 bits are truncated and only the low-order 16 bits are loaded into the destination operand.

This instruction performs the following checks before it loads the segment limit into the destination register:

- Checks that the segment selector is not NULL.
- Checks that the segment selector points to a descriptor that is within the limits of the GDT or LDT being accessed
- Checks that the descriptor type is valid for this instruction. All code and data segment descriptors are valid for (can be accessed with) the LSL instruction. The valid special segment and gate descriptor types are given in the following table.
- If the segment is not a conforming code segment, the instruction checks that the specified segment descriptor is visible at the CPL (that is, if the CPL and the RPL of the segment selector are less than or equal to the DPL of the segment selector).

If the segment descriptor cannot be accessed or is an invalid type for the instruction, the ZF flag is cleared and no value is loaded in the destination operand.

Table 3-55. Segment and Gate Descriptor Types

Type	Protected Mode		IA-32e Mode	
	Name	Valid	Name	Valid
0	Reserved	No	Reserved	No
1	Available 16-bit TSS	Yes	Reserved	No
2	LDT	Yes	LDT <sup>1</sup>	Yes
3	Busy 16-bit TSS	Yes	Reserved	No
4	16-bit call gate	No	Reserved	No
5	16-bit/32-bit task gate	No	Reserved	No
6	16-bit interrupt gate	No	Reserved	No
7	16-bit trap gate	No	Reserved	No
8	Reserved	No	Reserved	No
9	Available 32-bit TSS	Yes	64-bit TSS <sup>1</sup>	Yes
A	Reserved	No	Reserved	No
B	Busy 32-bit TSS	Yes	Busy 64-bit TSS <sup>1</sup>	Yes
C	32-bit call gate	No	64-bit call gate	No
D	Reserved	No	Reserved	No
E	32-bit interrupt gate	No	64-bit interrupt gate	No
F	32-bit trap gate	No	64-bit trap gate	No

**NOTES:**

1. In this case, the descriptor comprises 16 bytes; bits 12:8 of the upper 4 bytes must be 0.

**Operation**

```
IF SRC(Offset) > descriptor table limit
  THEN ZF ← 0; FI;
```

Read segment descriptor;

```
IF SegmentDescriptor(Type) ≠ conforming code segment
and (CPL > DPL) OR (RPL > DPL)
or Segment type is not valid for instruction
```

```
  THEN
```

```
    ZF ← 0;
```

```
  ELSE
```

```
    temp ← SegmentLimit([SRC]);
```

```
    IF (G ← 1)
```

```
      THEN temp ← ShiftLeft(12, temp) OR 00000FFFH;
```

```
    ELSE IF OperandSize = 32
```

```
      THEN DEST ← temp; FI;
```

```
    ELSE IF OperandSize = 64 (* REX.W used *)
```

```
      THEN DEST (* Zero-extended *) ← temp; FI;
```

```
    ELSE (* OperandSize = 16 *)
```

```
      DEST ← temp AND FFFFH;
```

```
    FI;
```

```
FI;
```

**Flags Affected**

The ZF flag is set to 1 if the segment limit is loaded successfully; otherwise, it is set to 0.

**Protected Mode Exceptions**

#GP(0)	If a memory operand effective address is outside the CS, DS, ES, FS, or GS segment limit. If the DS, ES, FS, or GS register is used to access memory and it contains a NULL segment selector.
#SS(0)	If a memory operand effective address is outside the SS segment limit.
#PF(fault-code)	If a page fault occurs.
#AC(0)	If alignment checking is enabled and the memory operand effective address is unaligned while the current privilege level is 3.
#UD	If the LOCK prefix is used.

**Real-Address Mode Exceptions**

#UD	The LSL instruction cannot be executed in real-address mode.
-----	--

**Virtual-8086 Mode Exceptions**

#UD	The LSL instruction cannot be executed in virtual-8086 mode.
-----	--

**Compatibility Mode Exceptions**

Same exceptions as in protected mode.

**64-Bit Mode Exceptions**

#SS(0)	If the memory operand effective address referencing the SS segment is in a non-canonical form.
#GP(0)	If the memory operand effective address is in a non-canonical form.
#PF(fault-code)	If a page fault occurs.
#AC(0)	If alignment checking is enabled and the memory operand effective address is unaligned while the current privilege level is 3.
#UD	If the LOCK prefix is used.

## LTR—Load Task Register

Opcode	Instruction	Op/En	64-Bit Mode	Compat/Leg Mode	Description
0F 00 /3	LTR <i>r/m16</i>	M	Valid	Valid	Load <i>r/m16</i> into task register.

### Instruction Operand Encoding

Op/En	Operand 1	Operand 2	Operand 3	Operand 4
M	ModRM: <i>r/m</i> ( <i>r</i> )	NA	NA	NA

### Description

Loads the source operand into the segment selector field of the task register. The source operand (a general-purpose register or a memory location) contains a segment selector that points to a task state segment (TSS). After the segment selector is loaded in the task register, the processor uses the segment selector to locate the segment descriptor for the TSS in the global descriptor table (GDT). It then loads the segment limit and base address for the TSS from the segment descriptor into the task register. The task pointed to by the task register is marked busy, but a switch to the task does not occur.

The LTR instruction is provided for use in operating-system software; it should not be used in application programs. It can only be executed in protected mode when the CPL is 0. It is commonly used in initialization code to establish the first task to be executed.

The operand-size attribute has no effect on this instruction.

In 64-bit mode, the operand size is still fixed at 16 bits. The instruction references a 16-byte descriptor to load the 64-bit base.

### Operation

IF SRC is a NULL selector  
THEN #GP(0);

IF SRC(Offset) > descriptor table limit OR IF SRC(type) ≠ global  
THEN #GP(segment selector); FI;

Read segment descriptor;

IF segment descriptor is not for an available TSS  
THEN #GP(segment selector); FI;

IF segment descriptor is not present  
THEN #NP(segment selector); FI;

TSSsegmentDescriptor(busy) ← 1;

(\* Locked read-modify-write operation on the entire descriptor when setting busy flag \*)

TaskRegister(SegmentSelector) ← SRC;

TaskRegister(SegmentDescriptor) ← TSSSegmentDescriptor;

### Flags Affected

None

**Protected Mode Exceptions**

#GP(0)	If the current privilege level is not 0. If a memory operand effective address is outside the CS, DS, ES, FS, or GS segment limit. If the source operand contains a NULL segment selector. If the DS, ES, FS, or GS register is used to access memory and it contains a NULL segment selector.
#GP(selector)	If the source selector points to a segment that is not a TSS or to one for a task that is already busy. If the selector points to LDT or is beyond the GDT limit.
#NP(selector)	If the TSS is marked not present.
#SS(0)	If a memory operand effective address is outside the SS segment limit.
#PF(fault-code)	If a page fault occurs.
#UD	If the LOCK prefix is used.

**Real-Address Mode Exceptions**

#UD	The LTR instruction is not recognized in real-address mode.
-----	---

**Virtual-8086 Mode Exceptions**

#UD	The LTR instruction is not recognized in virtual-8086 mode.
-----	---

**Compatibility Mode Exceptions**

Same exceptions as in protected mode.

**64-Bit Mode Exceptions**

#SS(0)	If a memory address referencing the SS segment is in a non-canonical form.
#GP(0)	If the current privilege level is not 0. If the memory address is in a non-canonical form. If the source operand contains a NULL segment selector.
#GP(selector)	If the source selector points to a segment that is not a TSS or to one for a task that is already busy. If the selector points to LDT or is beyond the GDT limit. If the descriptor type of the upper 8-byte of the 16-byte descriptor is non-zero.
#NP(selector)	If the TSS is marked not present.
#PF(fault-code)	If a page fault occurs.
#UD	If the LOCK prefix is used.

## LZCNT— Count the Number of Leading Zero Bits

Opcode/Instruction	Op/En	64/32-bit Mode	CPUID Feature Flag	Description
F3 0F BD /r	RM	V/V	LZCNT	Count the number of leading zero bits in r/m16, return result in r16.
LZCNT r16, r/m16				
F3 0F BD /r	RM	V/V	LZCNT	Count the number of leading zero bits in r/m32, return result in r32.
LZCNT r32, r/m32				
F3 REX.W 0F BD /r	RM	V/N.E.	LZCNT	Count the number of leading zero bits in r/m64, return result in r64.
LZCNT r64, r/m64				

### Instruction Operand Encoding

Op/En	Operand 1	Operand 2	Operand 3	Operand 4
RM	ModRM:reg (w)	ModRM:r/m (r)	NA	NA

### Description

Counts the number of leading most significant zero bits in a source operand (second operand) returning the result into a destination (first operand).

LZCNT differs from BSR. For example, LZCNT will produce the operand size when the input operand is zero. It should be noted that on processors that do not support LZCNT, the instruction byte encoding is executed as BSR.

In 64-bit mode 64-bit operand size requires REX.W=1.

### Operation

```
temp ← OperandSize - 1
DEST ← 0
WHILE (temp >= 0) AND (Bit(SRC, temp) = 0)
DO
    temp ← temp - 1
    DEST ← DEST + 1
OD

IF DEST = OperandSize
    CF ← 1
ELSE
    CF ← 0
FI

IF DEST = 0
    ZF ← 1
ELSE
    ZF ← 0
FI
```

### Flags Affected

ZF flag is set to 1 in case of zero output (most significant bit of the source is set), and to 0 otherwise, CF flag is set to 1 if input was zero and cleared otherwise. OF, SF, PF and AF flags are undefined.

**Intel C/C++ Compiler Intrinsic Equivalent**

LZCNT:      unsigned \_\_int32 \_lzcnt\_u32(unsigned \_\_int32 src);

LZCNT:      unsigned \_\_int64 \_lzcnt\_u64(unsigned \_\_int64 src);

**Protected Mode Exceptions**

- #GP(0)            For an illegal memory operand effective address in the CS, DS, ES, FS or GS segments.  
If the DS, ES, FS, or GS register is used to access memory and it contains a null segment selector.
- #SS(0)            For an illegal address in the SS segment.
- #PF (fault-code)   For a page fault.
- #AC(0)            If alignment checking is enabled and an unaligned memory reference is made while the current privilege level is 3.

**Real-Address Mode Exceptions**

- #GP(0)            If any part of the operand lies outside of the effective address space from 0 to 0FFFFH.
- #SS(0)            For an illegal address in the SS segment.

**Virtual 8086 Mode Exceptions**

- #GP(0)            If any part of the operand lies outside of the effective address space from 0 to 0FFFFH.
- #SS(0)            For an illegal address in the SS segment.
- #PF (fault-code)   For a page fault.
- #AC(0)            If alignment checking is enabled and an unaligned memory reference is made while the current privilege level is 3.

**Compatibility Mode Exceptions**

Same exceptions as in Protected Mode.

**64-Bit Mode Exceptions**

- #GP(0)            If the memory address is in a non-canonical form.
- #SS(0)            If a memory address referencing the SS segment is in a non-canonical form.
- #PF (fault-code)   For a page fault.
- #AC(0)            If alignment checking is enabled and an unaligned memory reference is made while the current privilege level is 3.